

KCU1250 10GBASE-KR Ethernet TRD User Guide

KUCon-TRD05

Vivado Design Suite

UG1058 (v2017.3) October 9, 2017

Revision History

The following table shows the revision history for this document.

Date	Version	Revision
10/09/2017	2017.3	Updated for Vivado Design Suite 2017.3. Updated design file <code>rdf0310-kcu1250-trd05-2017-3.zip</code> and Table C-8 .
06/20/2017	2017.2	Updated for Vivado Design Suite 2017.2. Updated design file <code>rdf0310-kcu1250-trd05-2017-2.zip</code> .
04/19/2017	2017.1	Updated for Vivado Design Suite 2017.1. Updated design file <code>rdf0310-kcu1250-trd05-2017-1.zip</code> . Updated sections Configure VIO and Forward Error Correction . Added a note about screens in Install Vivado Design Suite .
12/15/2016	2016.4	Updated for Vivado Design Suite 2016.4. Updated design file <code>rdf0310-kcu1250-trd05-2016-4.zip</code> .
11/28/2016	2016.3	Changed <code>rdf310-kcu1250-trd05-2016-3.zip</code> file name to <code>rdf0310-kcu1250-trd05-2016-3.zip</code> .
10/12/2016	2016.3	Updated for Vivado Design Suite 2016.3. Re-added Chapter 3, Bringing Up the Design . Updated Appendix D, Additional Resources and Legal Notices .
06/08/2016	2016.2	Replaced all references to Vivado Design Suite version 2016.1 with version 2016.2.
04/13/2016	2016.1	Replaced all references to Vivado Design Suite version 2015.4 with version 2016.1.
11/23/2015	2015.4	Replaced all references to Vivado Design Suite version 2015.3 with version 2015.4.
10/02/2015	2015.3	Replaced all references to Vivado Design Suite version 2015.2 with version 2015.3.
06/30/2015	2015.2	Replaced all references to Vivado Design Suite version 2015.1 with version 2015.2. Added step c, page 23 under step 6, page 23 . Added new step 2, page 25 and new step 2, page 39 .
04/27/2015	2015.1	Replaced all references to Vivado Design Suite version 2014.4.1 with version 2015.1. added [Ref 1] to the to the first listed item under Hardware, page 10 . Updated the Quad Transceiver names in step 1 and TX and RX cable names in step 2 under Connect Bulls Eye Cables, page 19 . Updated the Quad Transceiver names in Figure 3-1 . Updated step 4, page 20 . Updated screen capture in Figure 3-8 . Reversed the order of content in the VIO_Tab column in Table 3-1 from <code>hw_vio_1 > hw_vio_6</code> to <code>hw_vio_6 > hw_vio_1</code> . Updated screen captures in Figure 3-9 , Figure 3-10 , Figure 3-11 , Figure 3-18 , Figure 3-19 , and Figure 3-20 . Revised the order of content in the VIO_Tab column in Table 3-2 .
03/04/2015	2014.4.1	Initial Xilinx release.

Table of Contents

Revision History	2
Chapter 1: Introduction	
10GBASE-KR TRD Overview	5
Chapter 2: Setup	
Requirements	10
Preliminary Setup	11
Chapter 3: Bringing Up the Design	
Set Up the KCU1250 Board	19
Program the Clocks Sources	22
Program the FPGA	23
Configure VIO	25
Running the Design	31
Forward Error Correction	38
Dynamic Reconfiguration Ports	42
Chapter 4: Implementing and Simulating the Design	
Implementing the Design	43
Simulating the Design	60
Chapter 5: Reference Design Details	
Hardware	63
Software	76
Appendix A: Directory Structure	
Directory Content Summary	83
Appendix B: Performance Estimates	
Appendix C: User-Space Registers	
Control and Status Registers	85

Appendix D: Additional Resources and Legal Notices

Xilinx Resources	89
Solution Centers	89
Documentation Navigator and Design Hubs	89
References	90
Training Resources	91
Please Read: Important Legal Notices	91

Introduction

This document describes the features and functions of the 10GBASE-KR Ethernet targeted reference design (10GBASE-KR TRD). It also describes how to set up, operate, test, and modify the design.

10GBASE-KR TRD Overview

The 10GBASE-KR TRD ([Figure 1-1](#)) targets the Kintex® UltraScale™ XCKU040-2FFVA1156C FPGA running on the KCU1250 characterization board. It demonstrates connectivity between the 10-Gigabit Ethernet PCS/PMA IP core (10GBASE-KR) and the 10-Gigabit Ethernet MAC IP core (10G MAC) and error free traffic flow on this 10-Gigabit Ethernet channel across a backplane.

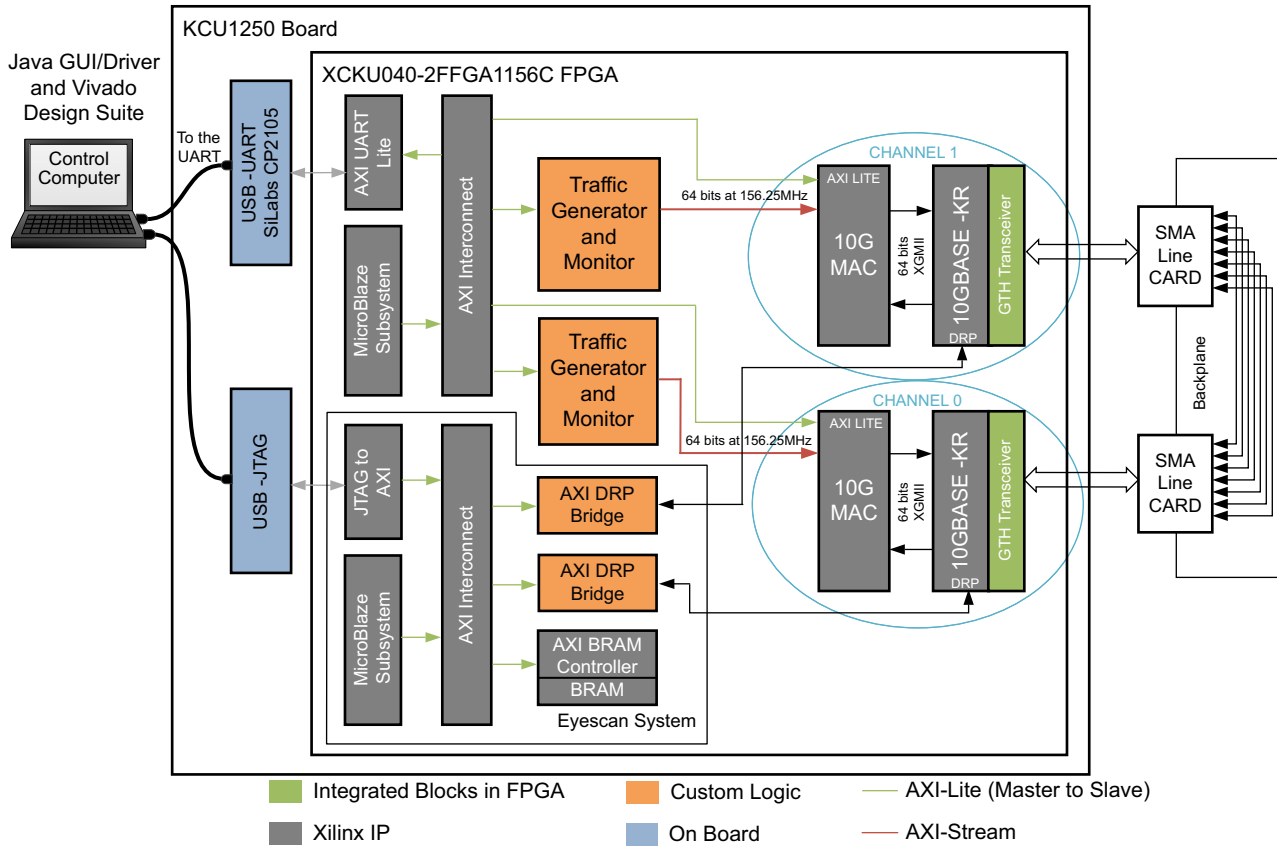

X18426-120716

Figure 1-1: The 10GBASE-KR TRD

10GBASE-KR is defined in *IEEE Std 802.3-2012* [Ref 1]. It specifies the 10 Gb/s physical layer specification using 10GBASE-R encoding over an electrical backplane.

The 10GBASE-KR TRD has two 10 Gb/s Ethernet channels; channel 0 and channel 1. Transmit data is generated by the Traffic Generator and Monitor block. Data from one channel is looped back to the other channel on a backplane through SMA cables as shown in Figure 3-2. The looped-back data becomes the receive data on the other channel and the frame length and frame check sequence (FCS) are verified by the 10-Gigabit Ethernet MAC IP core.

A MicroBlaze™ processor subsystem monitors the 10-Gigabit Ethernet MAC IP core statistics. It also controls the Traffic Generator and Monitor block and reports Ethernet performance. It passes this information to the Ethernet Controller application GUI running on the control computer via the USB-to-UART port on the KCU1250 board.

Components, Features, and Functions

The 10GBASE-KR TRD includes:

- 10-Gigabit Ethernet PCS/PMA IP core (10GBASE-KR):
 - Uses GTH transceivers running at 10.3125 Gb/s line rate.
 - Provides a single data rate (SDR) 10-Gigabit Ethernet Media Independent Interface (XGMII) which connects to the 10-Gigabit Ethernet MAC IP core. The XGMII interface runs at 156.25 MHz and the data path is 64-bits wide.
 - Provides a serial interface to connect to the backplane.
 - Auto-negotiation (AN) and forward error connection (FEC) is enabled.
 - Is monitored and configured through status and configuration vectors.
- 10-Gigabit Ethernet MAC IP core (10G MAC):
 - Connects to the 10-Gigabit Ethernet PCS/PMA IP core using the XGMII interface.
 - Provides AXI4-Stream protocol support on the user interface running at 156.25 MHz.
 - Is monitored through an AXI4-Lite interface.
- Traffic Generator and Monitor:
 - Generates Ethernet traffic.
 - Monitors bandwidth utilization on the transmit and receive AXI4-Stream interfaces of the 10-Gigabit Ethernet MAC IP core.
 - Is configured and monitored through an AXI4-Lite interface.
- AXI UART Lite:
 - Provides the controller interface for asynchronous serial data transfer. This interface connects to the USB-to-UART port on the KCU1250 board, and is used to communicate with the control computer.
 - Provides an AXI4-Lite interface to communicate with the MicroBlaze processor subsystem.
- MicroBlaze processor subsystem and AXI Interconnect:
 - Communicates with the 10-Gigabit Ethernet MAC IP core, Traffic Generator and Monitor, and AXI UART Lite using the AXI4-Lite protocol.
 - Drivers running on the MicroBlaze processor subsystem interpret commands received from the Ethernet Controller application GUI running on the control computer and convert them to AXI4-Lite transactions.

- Ethernet Controller application GUI/Driver:
 - Provides a graphical user interface running on the control computer to pass user inputs to the 10GBASE-KR TRD and to display status through the KCU1250 board USB-to-UART port.
- Eye scan system:
 - AXI DRP bridge:
 - Custom logic that allows access to DRP registers of the transceiver through any AXI master such as the MicroBlaze processor subsystem.
 - AXI block RAM controller:
 - An AXI slave IP core that allows access to local block RAM by AXI master devices such as the MicroBlaze processor subsystem and the JTAG to AXI Master IP core.
 - The block RAM stores the data read from the DRP port of the transceiver.
 - JTAG to AXI Master:
 - An AXI Master IP core that can generate AXI transactions and drive AXI signals internal to FPGA in the system.
 - Communicates with the AXI block RAM controller via the AXI Interconnect.
 - Allows the Vivado® tools logic analyzer Tcl console running on the control computer to interact with FPGA through the USB-to-JTAG port on the KCU1250 board.
 - MicroBlaze processor subsystem:
 - An AXI Master that communicates with the AXI DRP bridge and AXI block RAM controller via the AXI Interconnect.
 - Drivers running on the MicroBlaze processor subsystem implement an algorithm to measure a statistical eye (bit error ratio (BER) versus time and voltage offset). Data sampling points are available to read via the DRP port of the transceiver. Point-by-point measured data is stored in a block RAM to be burst read by the control computer via the JTAG to AXI Master.
 - AXI Interconnect:
 - Allows multiple AXI masters (MicroBlaze processor subsystem and JTAG to AXI Master) to communicate with multiple AXI slaves (AXI DRP Bridge and AXI block RAM controller).

Resource Utilization

Table 1-1 lists the resources used by the 10GBASE-KR TRD after synthesis has run. Place and route can alter these numbers based on placements and routing paths, so use these numbers as a rough estimate of resource utilization. These numbers might vary based on the version of the 10GBASE-KR TRD and the tools used to regenerate the design.

Table 1-1: 10GBASE-KR TRD Resource Utilization

Site Type	Used	Available	Usage (%)
CLB LUTs	29,846	242,400	12.31
CLB Registers	41,794	484,800	8.62
Block RAM Tile	42	600	6.91
Global Clock Buffers	2	240	0.83
BUFG_GT_SYNC	6	55	10.90
BUFG_GT	6	120	5.00
GTHE3_CHANNEL	2	20	10.00
GTHE3_COMMON	2	5	40.00

Setup

This chapter lists the requirements and describes how to do all preliminary setup of the KCU1250 board, control computer, and software before bringing up the 10GBASE-KR TRD.



IMPORTANT: Perform the procedures described in this chapter before performing the bring up procedures described in [Chapter 3, Bringing Up the Design](#).

Requirements

Hardware

- KCU1250 board with the Kintex® UltraScale™ XCKU040-2FFVA1156C FPGA [\[Ref 2\]](#)
- Two USB cables, standard-A plug to micro-B plug
- Power Supply: 100 VAC–240 VAC input, 12 VDC 5.0A output
- Backplane: Z-Pack TINMAN Customer System kit from Tyco Electronics [\[Ref 3\]](#)
- Two Samtec Bulls Eye® cables from Avnet [\[Ref 4\]](#)
- Four DC Blocks/AC capacitors from Aeroflex [\[Ref 5\]](#)

Computer

One computer is required, and is identified as the control computer throughout this document. It is required for running the Vivado® Design Suite, configuring the FPGA, and running the Ethernet Controller application GUI to control and monitor the reference design. It can be a laptop or desktop computer with Microsoft Windows 7 Operating system.

Design Tools and Software

- Vivado Design Suite 2017.3
- USB UART drivers (CP210x VCP drivers) [\[Ref 6\]](#)
- Tera Term [\[Ref 7\]](#)

- Java SE Runtime Environment 7
- Ethernet Controller application GUI (included with the 10GBASE-KR TRD)
- 10GBASE-KR Ethernet targeted reference design files

Download and installation instructions for each required software application and for the 10GBASE-KR Ethernet targeted reference design files are described in [Preliminary Setup](#).

Preliminary Setup

Complete these tasks before bringing up the design described in [Chapter 3, Bringing Up the Design](#).

Install Vivado Design Suite

Install Vivado Design Suite 2017.3 on the control computer. Follow the installation instructions provided in *Vivado Design Suite User Guide Release Notes, Installation, and Licensing* (UG973) [\[Ref 8\]](#).

Note: Snapshots of the Vivado integrated design environment (IDE) in this document are from an older version of Vivado tools, but the text and fields are still relevant to the current version.

Download Targeted Reference Design Files

1. Download the 10GBASE-R TRD ZIP file `rd0310-kcu1250-trd05-2017-3.zip` from [KCU1250 Characterization Kit Documentation](#).
2. Unzip the contents of the file to a working directory.
3. The unzipped contents will be located at `<working_dir>/kcu1250_10gbasekr_trd`.

The 10GBASE-KR TRD directory structure is described in [Appendix A, Directory Structure](#).

Install the USB UART Drivers

Download the *CP210x USB to UART Bridge VCP drivers* (for Windows 7) from [Silicon Labs](#). Follow the instructions in *Silicon Labs CP210x USB-to-UART Installation Guide* (UG1033) [\[Ref 9\]](#).

Configure the Control Computer COM Port

The TRD uses the Tera Term Pro terminal emulator and the Ethernet Controller application GUI to communicate between the control computer and the KCU1250 board. To configure the control computer COM ports for this purpose:

1. Place switch SW1 to the OFF position. (SW1 in [Figure 2-1](#)).
2. Connect the KCU1250 board to the control computer and power supply as shown in [Figure 2-1](#).



TIP: [Figure 2-1](#) shows only the top edge of the KCU1250 board.

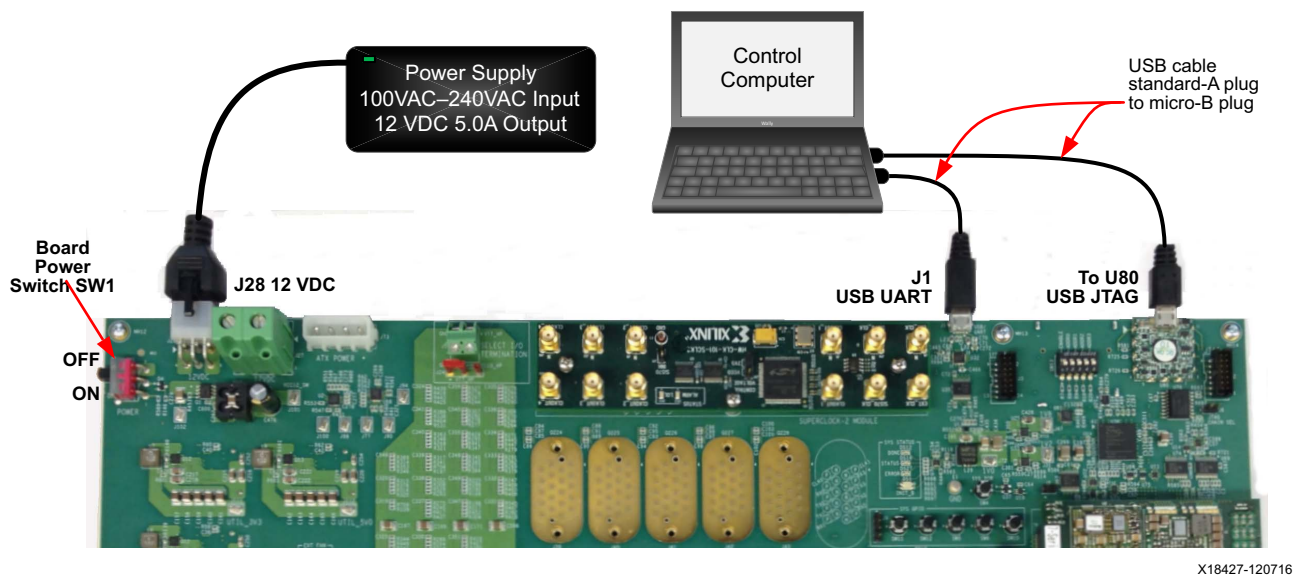

X18427-120716

Figure 2-1: Connections for Preliminary Setup

3. Power on the KCU1250 board by placing switch SW1 to the ON position. (SW1 in [Figure 2-1](#)).

4. Open the control computer Device Manager. In the Windows task bar, click **Start**, click **Control Panel**, and then click **Device Manager**.
5. In the Device Manager window (Figure 2-2), expand **Ports (COM & LPT)**, right-click **Silicon Labs CP210x USB to UART Bridge: Standard COM Port**, and then click **Properties**.

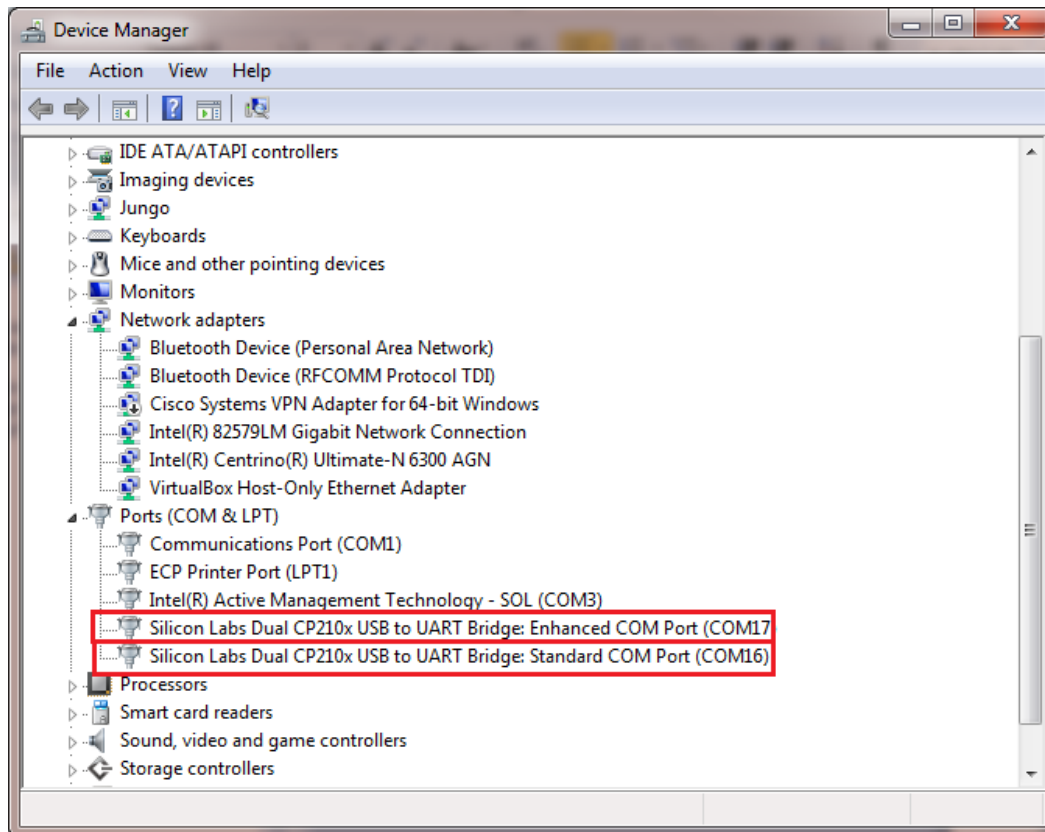

X18434-120716

Figure 2-2: Device Manager



TIP: Make note of the COM port numbers assigned by the control computer OS in your setup to **Silicon Labs CP210x USB to UART Bridge: Standard COM Port** and **Silicon Labs CP210x USB to UART Bridge: Enhanced COM Port**. The Enhanced COM port number must be provided to the Tera Term Pro terminal emulator in [step 2, page 15](#). The Standard COM port number must be provided to the Ethernet Controller application in [step 2, page 31](#).

6. In the properties window, select the **Port Settings** tab (Figure 2-3).
7. Set **Bits per second**, **Data bits**, **Parity**, **Stop bits**, and **Flow control** to the values shown in Figure 2-3, and click **OK**.

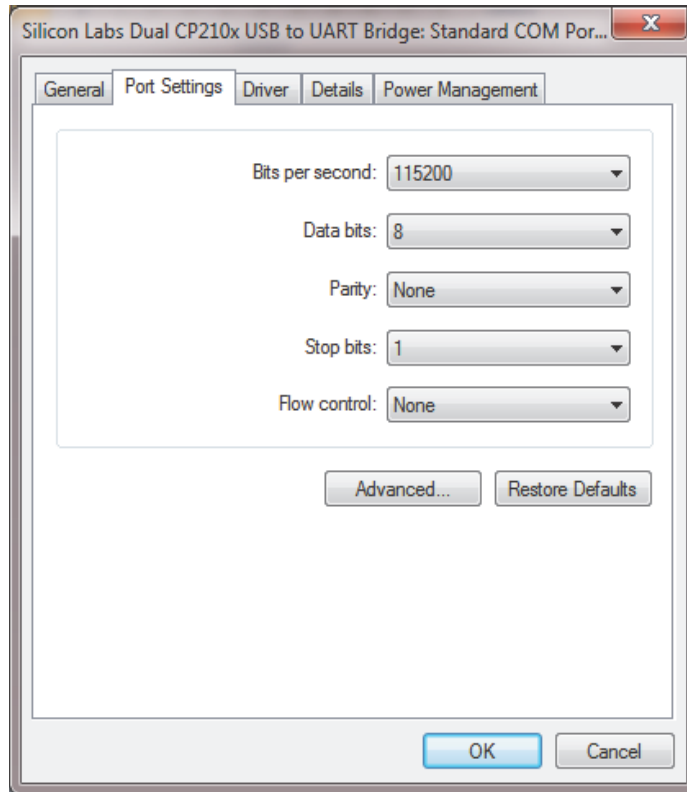

X18435-120716

Figure 2-3: Port Settings

8. In the Device Manager window (Figure 2-2), expand **Ports (COM & LPT)**, right-click **Silicon Labs CP210x USB to UART Bridge: Enhanced COM Port** and then click **Properties**.
9. In the properties window, select the **Port Settings** tab and set **Bits per second**, **Data bits**, **Parity**, **Stop bits**, and **Flow control** to the values shown in (Figure 2-3), and then click **OK**.

Install Tera Term Pro Software

1. Follow the download and installation instructions provided in *Tera Term Terminal Emulator Installation Guide* (UG1036) [Ref 10].
2. To communicate with the KCU1250 board, configure the new Tera Term connection and serial port settings as shown in Figure 2-4. These settings must match the control computer COM port settings shown in Figure 2-3. Select the serial COM port associated with **Silicon Labs Dual CP210x USB to UART Bridge: Enhanced COM Port**.

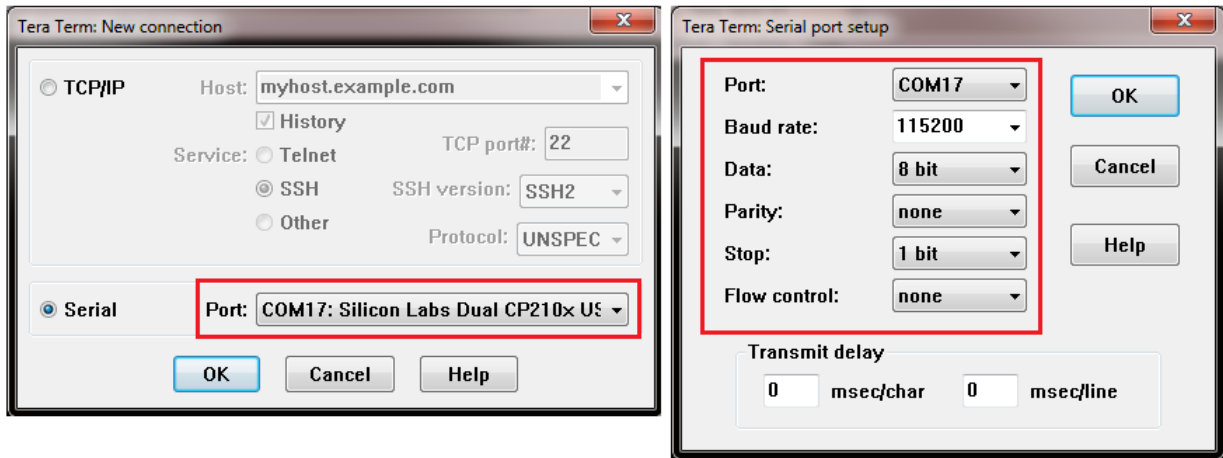

X18436-120716

Figure 2-4: Tera Term Pro Settings

Install Java

Download Java SE Runtime Environment 7 from Oracle [Ref 11] and install the program on the control computer. Follow the installation instructions provided with the software.

Install the Ethernet Controller Application

1. Browse to <working_dir>/kcu1250_10gbasekr_trd/software/GUI (Figure 2-5).

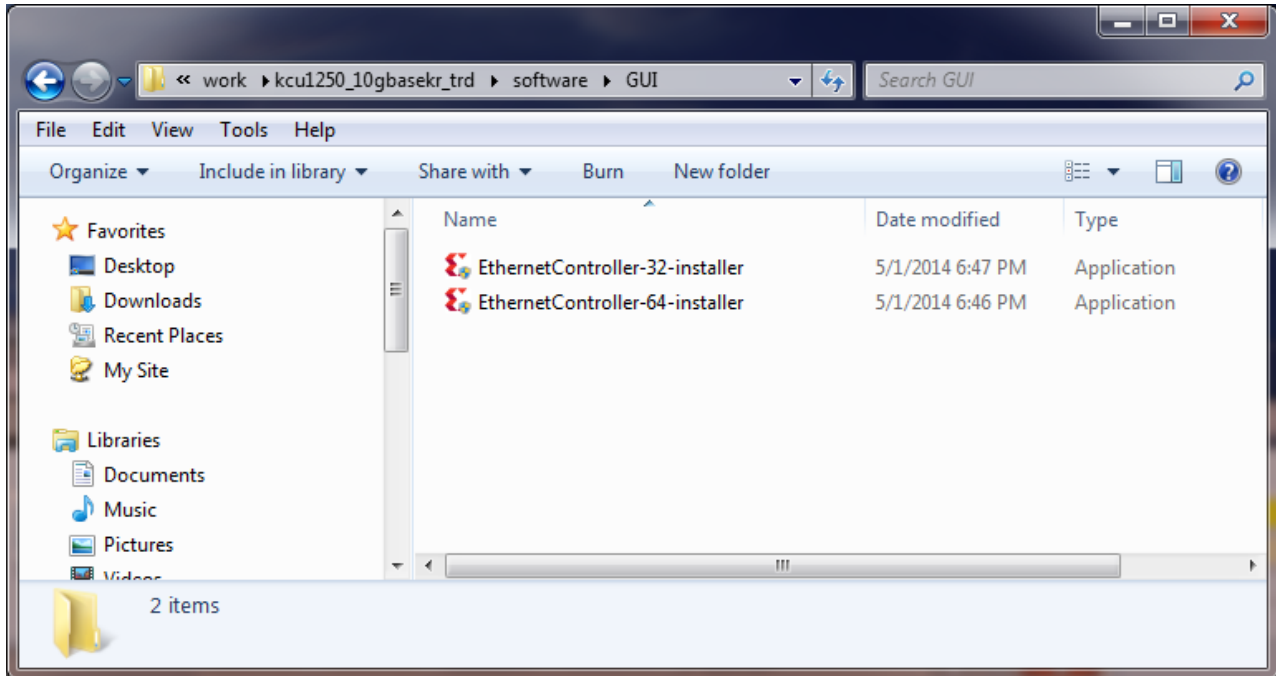

X18437-120716

Figure 2-5: Directory Location, Ethernet Controller Installer

2. Right-click either the **EthernetController-32-installer** (for a 32-bit operating system) or **EthernetController-64-installer** (for a 64-bit operating system) and select **Run as administrator** (Figure 2-5).
3. Click **Yes** in the dialog box that opens.

- In the License Agreement display (Figure 2-6), click **I Agree** to continue installation.

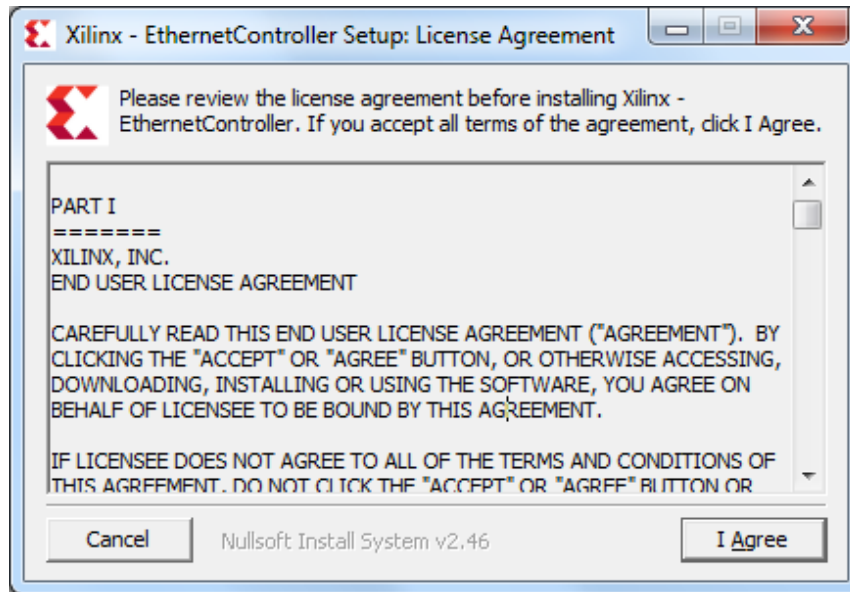

X18438-120716

Figure 2-6: License Agreement

- Browse to the location where the Ethernet Controller application will be installed and click **Install** (Figure 2-7).

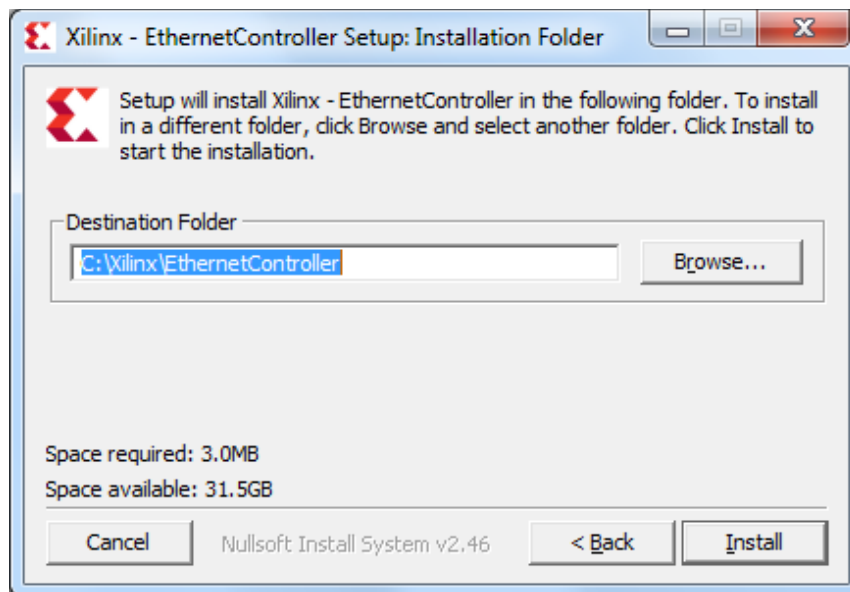

X18439-120716

Figure 2-7: Ethernet Controller Installation Location

- Click **Close** after installation is complete (Figure 2-8).

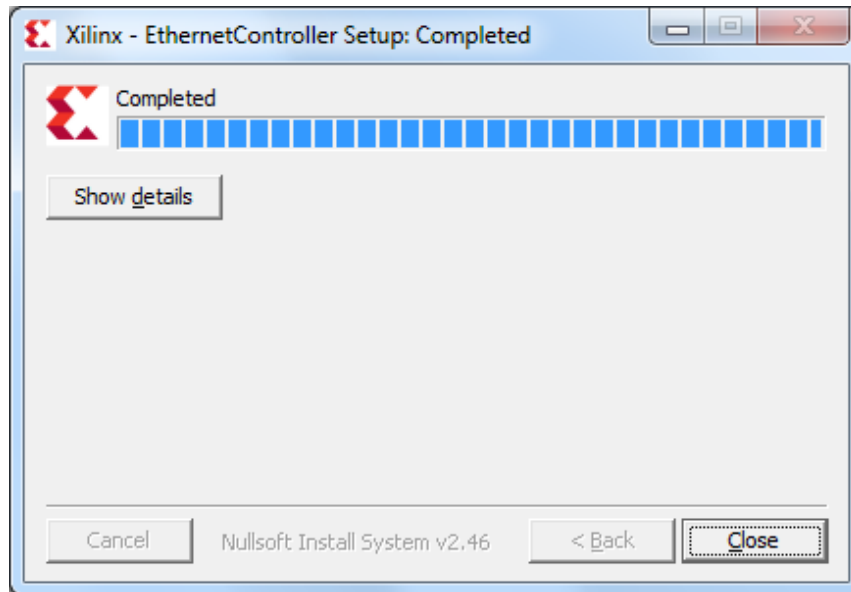

X18440-120716

Figure 2-8: Installation Complete



TIP: To uninstall the Ethernet Controller application after design bring up, open the Control Panel. In the Control Panel click **All Control Panel Items > Programs and Features** and uninstall program **Xilinx Ethernet Controller - Powered by Xilinx**.

Ready to Bring Up the Design

After all procedures in this chapter are complete, go to [Chapter 3, Bringing Up the Design](#).

Bringing Up the Design

This chapter describes how to bring up the 10GBASE-KR TRD. Instructions are provided for setting up the KCU1250 board and backplane, programming the clock, programming the FPGA, configuring virtual input/output (VIO), and running the Ethernet Controller application.



IMPORTANT: Perform the preliminary setup procedures described in [Chapter 2, Setup](#) before performing the bring up procedures described in this chapter.

Set Up the KCU1250 Board

Connect Bulls Eye Cables

1. Connect the SAMTEC Bulls Eye cables to J41 (GTH Transceiver Quad_226) and J42 (GTH Transceiver Quad_227) as described in this video:



VIDEO: [New GTX/GTH/GTZ Interconnect on Xilinx Characterization Boards](#)

2. The Bulls Eye SMA cables are numbered. Cable 15 is TX0_P, cable 16 is TX0_N, cable 17 is RX0_P and cable 18 is RX0_N. Connect the AC capacitors (Aeroflex SMA DC Blocks—[\[Ref 5\]](#)) to TXN and TXP SMA connector on both Bulls Eye cables. Refer to pages 51 and 52 of the *KCU1250 Characterization Board Schematics* (XTP398) [\[Ref 12\]](#).

3. Connect the SMA cables on the Bulls Eye connector to the Tyco backplane as shown in Figure 3-1.

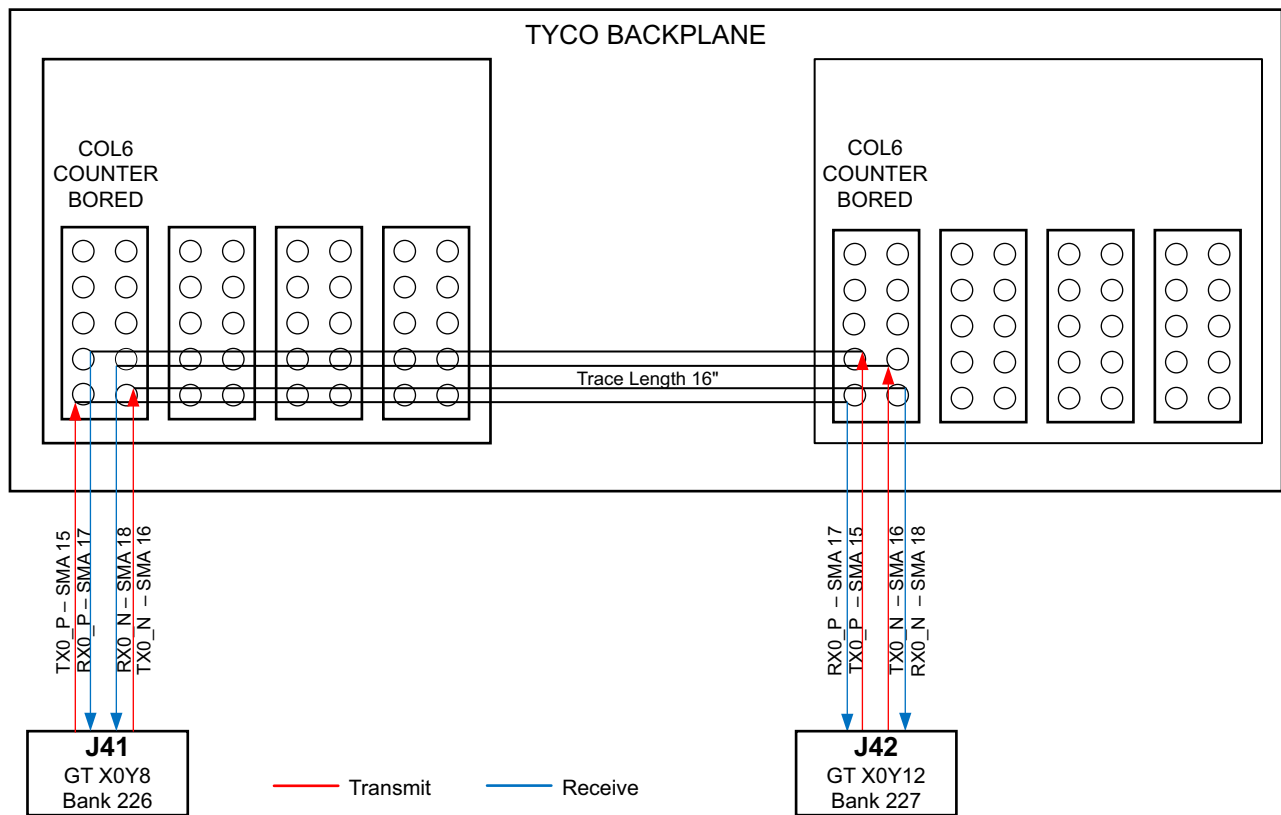

X18441-120716

Figure 3-1: SMA Connections to the Backplane

4. SMA cable 19 is REFCLK0_C_P and cable 20 is REFCLK0_C_N. Connect cable 19 and cable 20 from J41 to the clock out pins of Oscillator Si5368 on the Superclock module. Connect cable 19 and cable 20 from J42 to the clock out pins of Oscillator Si570 on the Superclock module.
5. Connect the power supply to the KCU1250 board.
6. Connect one end of the Micro-USB cable to USB-UART port (J1) and the other to the Control PC.
7. Connect one end of the Micro-USB cable to USB-JTAG port (U80) and the other to the Control PC.

All above connections are shown in [Figure 3-2](#).

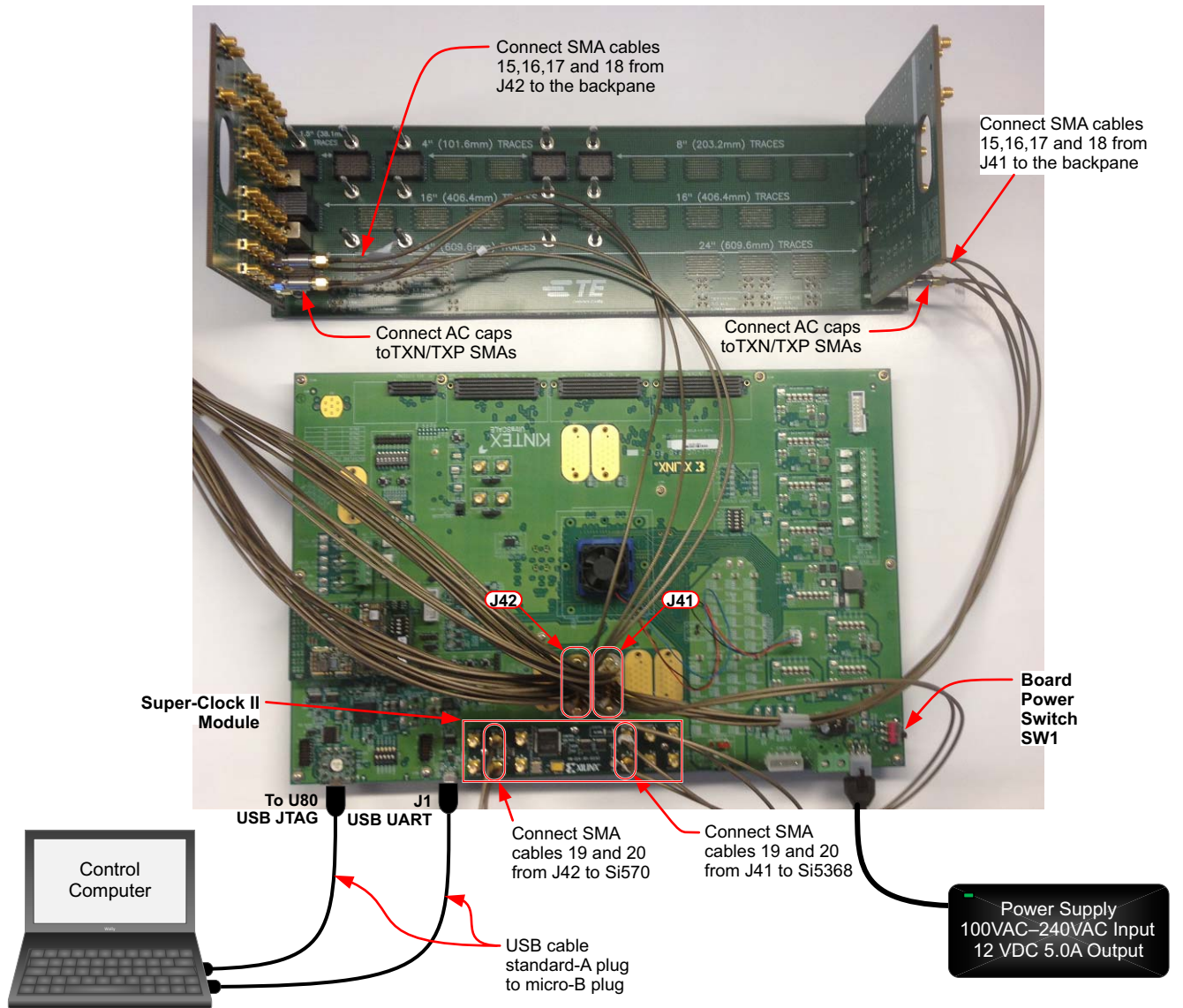

X18442-120716

Figure 3-2: KCU1250 Board Connections Including SMA Connections to the Backplane

8. Power on the KCU1250 board by placing switch SW1 to the ON position.

Program the Clocks Sources

The KCU1250 board uses the SuperClock-2 module to provides programmable, low-noise and low-jitter clock sources for the KCU1250 board. See *HW-CLK-101-SCLK2 SuperClock-2 Module User Guide (UG770)* [Ref 13] for more information.

To program the clock sources:

1. On the control computer, open the Tera Term Pro terminal program. Click **Start > All Programs > Tera Term > Tera Term**.
2. In the New connection window, configure the settings as shown in [Figure 3-3](#). Select the serial COM port associated with **Silicon Labs Dual CP210x USB to UART Bridge: Enhanced COM Port**. Click **OK**.

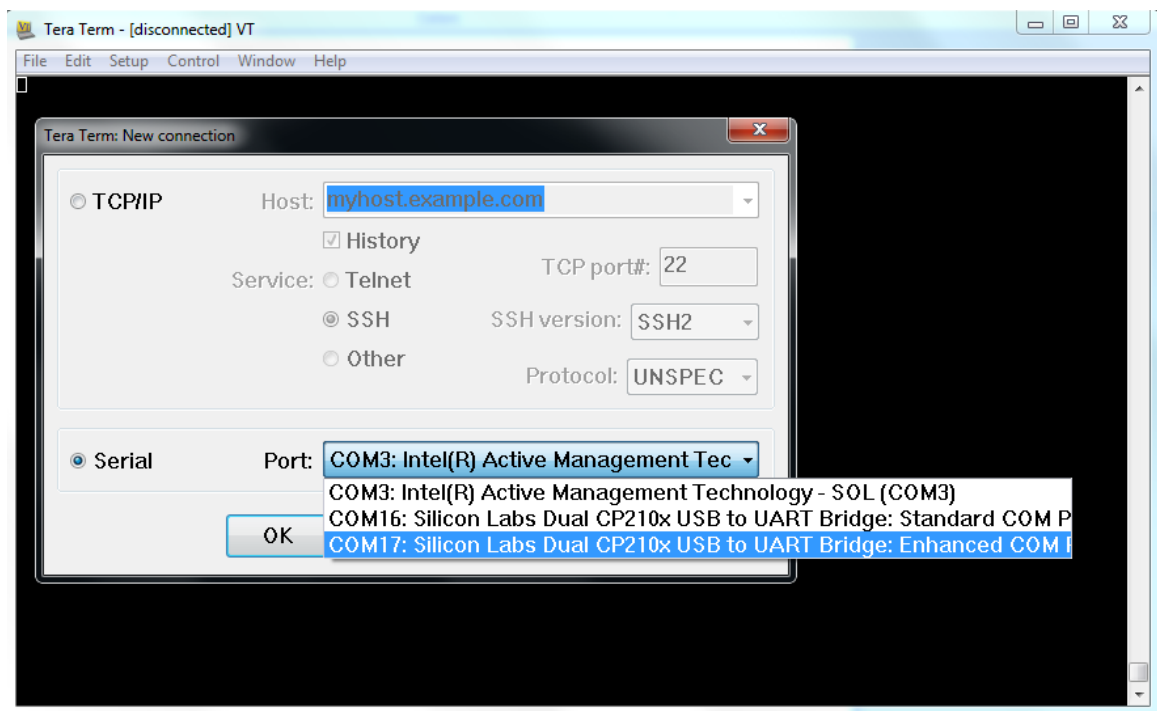

X18443-120716

Figure 3-3: Connect to Enhanced COM Port on Tera Term

3. On the control computer keyboard, press the `Enter` key. The Tera Term window will display the SuperClock-2 configuration menu.
4. Set Programmable Clocks:
 - a. Select option 1 (Set Programmable Clocks): Type 1, and press `Enter`.
5. Set the Si570 frequency to 156.25 MHz:
 - a. Select option 1 (Set KCU1250 Si570 frequency): Type 1, and press `Enter`.

- b. Enter the Si570 frequency in MHz: Type 156.25 and press Enter.
 6. Set the Si5368 frequency to 156.25 MHz:
 - a. Select option 2 (Set KCU1250 Si5368 frequency): Type 2, and press Enter.
 - b. Enter the Si5368 frequency in MHz: Type 156.25 and press Enter.
 - c. Choose Si5368 operating mode (Select Free-Run using XA-XB crystal): Type 2, and press Enter.
 7. Close the Tera Term Pro terminal program window.

Program the FPGA

1. Launch the Vivado® Integrated Design Environment (IDE) on the control computer:
 - a. In Windows, select **Start > All Programs > Xilinx Design Tools > Vivado 2017.3 > Vivado 2017.3**.
 - b. On the getting started page, click **Open Hardware Manager** (Figure 3-4).



X18444-120716

Figure 3-4: Open Hardware Manager

2. Open the connection wizard to initiate a connection to the KCU1250 board:
 - a. Click **Open a new hardware target** (Figure 3-5).

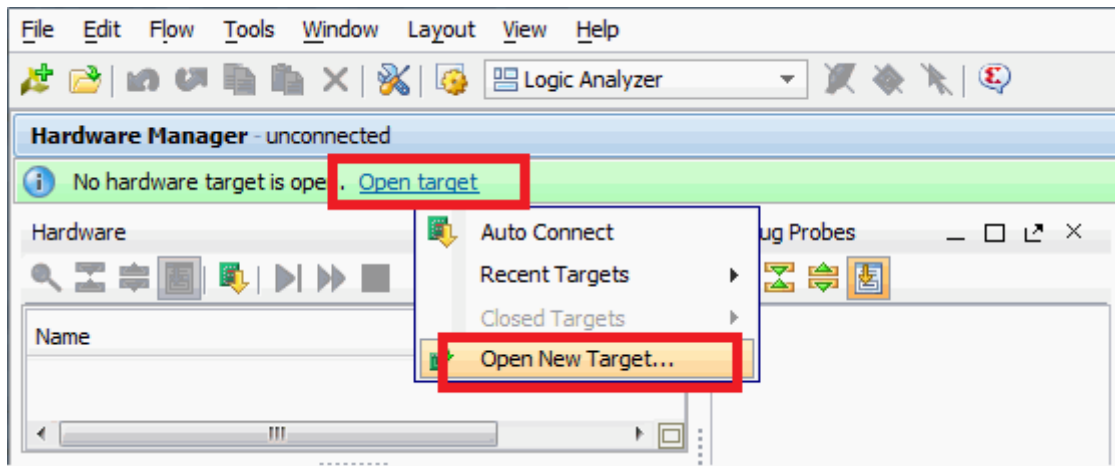

X18445-120716

Figure 3-5: Open a New Hardware Target

- b. Configure the wizard to establish connection with the KCU1250 board by selecting the default value on each wizard page. Click **Next > Next > Next > Finish**.
 - c. In the hardware view, right-click **xcku040** and click **Program Device** (Figure 3-6).

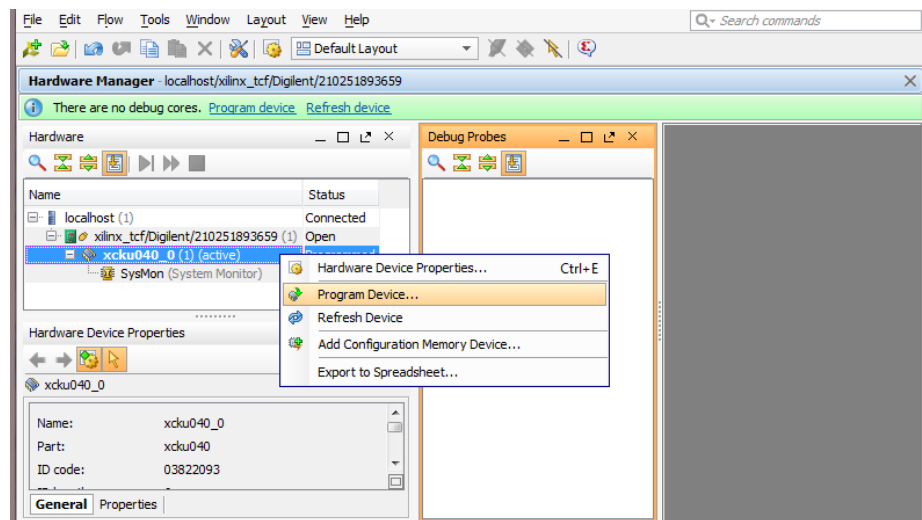

X18446-120716

Figure 3-6: Select Device to Program

- d. In the **Bitstream file** field, browse to the location of the BIT file:

```
<working_dir>/kcu1250_10gbasekr_trd/ready_to_test/kcu1250_10gbasekr_download.bit
```

- e. In the **Debug Probes file** field, browse to the location of the probes file:

`<working_dir>/kcu1250_10gbasekr_trd/ready_to_test/debug_nets.ltx`

and click **Program** (Figure 3-7).

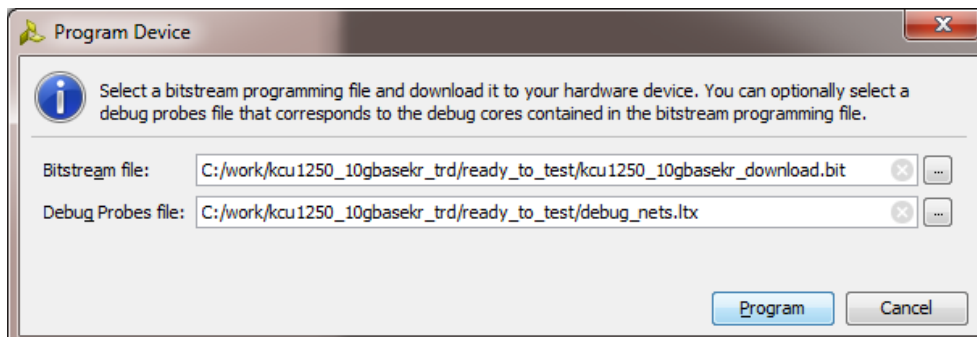

X18447-120716

Figure 3-7: Program Device Window

After completing these steps, continue on to [Configure VIO](#).

Configure VIO

There are six virtual I/O (VIO) cores in the reference design. After programming, each VIO core can be controlled in the Vivado IDE. To add probes to each VIO window:

1. Open the VIO dashboard. On the top panel of the Vivado IDE, click **Window > Dashboard > Reset to default**.
2. Open the Debug Probes window: on the top panel of the Vivado IDE click **Window > Debug Probes**.
3. In the Debug Probes window, right click on **hw_vio_1** and select **Add probes to VIO Window** (Figure 3-8).
4. Repeat the same procedure for **hw_vio_2**, **hw_vio_3**, **hw_vio_4**, **hw_vio_5** and **hw_vio_6**.

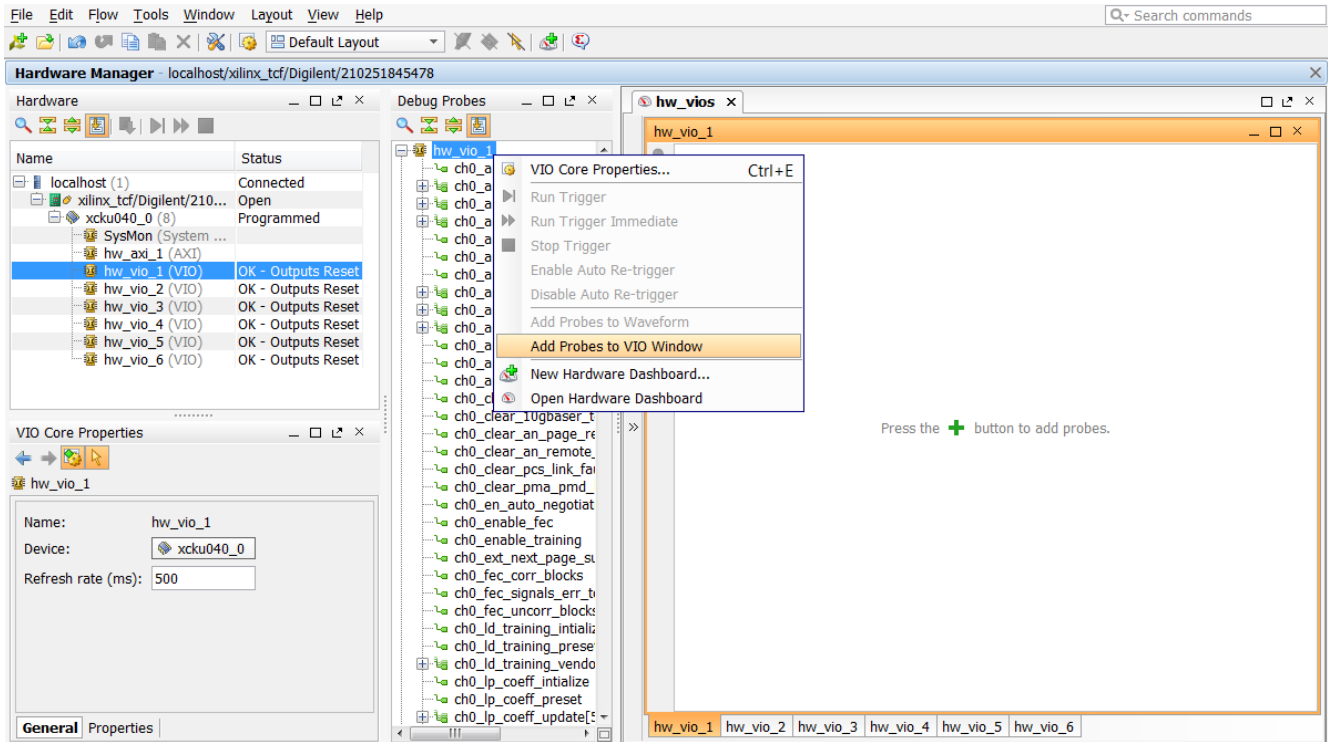

X18448-120716

Figure 3-8: Adding a Probe to a VIO Window

Table 3-1 shows what each VIO window configures and monitors.

Table 3-1: VIO Tab Mapping

VIO Tab	Mapping	Comments
hw_vio_6 ⁽¹⁾	training_*_ch1	Configures the DRP port for channel 1 through the training port of the 10-Gigabit Ethernet PCS/PMA IP core.
hw_vio_5 ⁽¹⁾	training_*_ch0	Configures the DRP port for channel 0 through the training port of the 10-Gigabit Ethernet PCS/PMA IP core.
hw_vio_4 ⁽¹⁾	stat_ch1_*	Monitors the status vector signals of the 10-Gigabit Ethernet PCS/PMA IP core for channel 1.
hw_vio_3 ⁽¹⁾	stat_ch0_*	Monitors the status vector signals of the 10-Gigabit Ethernet PCS/PMA IP core for channel 0.
hw_vio_2 ⁽¹⁾	ch1_*	Configures the configuration vector signals of the 10-Gigabit Ethernet PCS/PMA IP core for channel 1.
hw_vio_1 ⁽¹⁾	ch0_*	Configures the configuration vector signals of the 10-Gigabit Ethernet PCS/PMA IP core for channel 0.

Notes:

1. The value of *n* in hw_vio_*n* might change based on how the Vivado Synthesis tool processes the netlist. You might have to redo the above mapping accordingly.

- Verify if `stat_ch0_pcs_rx_link_status` and `stat_ch1_pcs_rx_link_status` is 1. This indicates that the 10GBASE-R link is up (Figure 3-9).

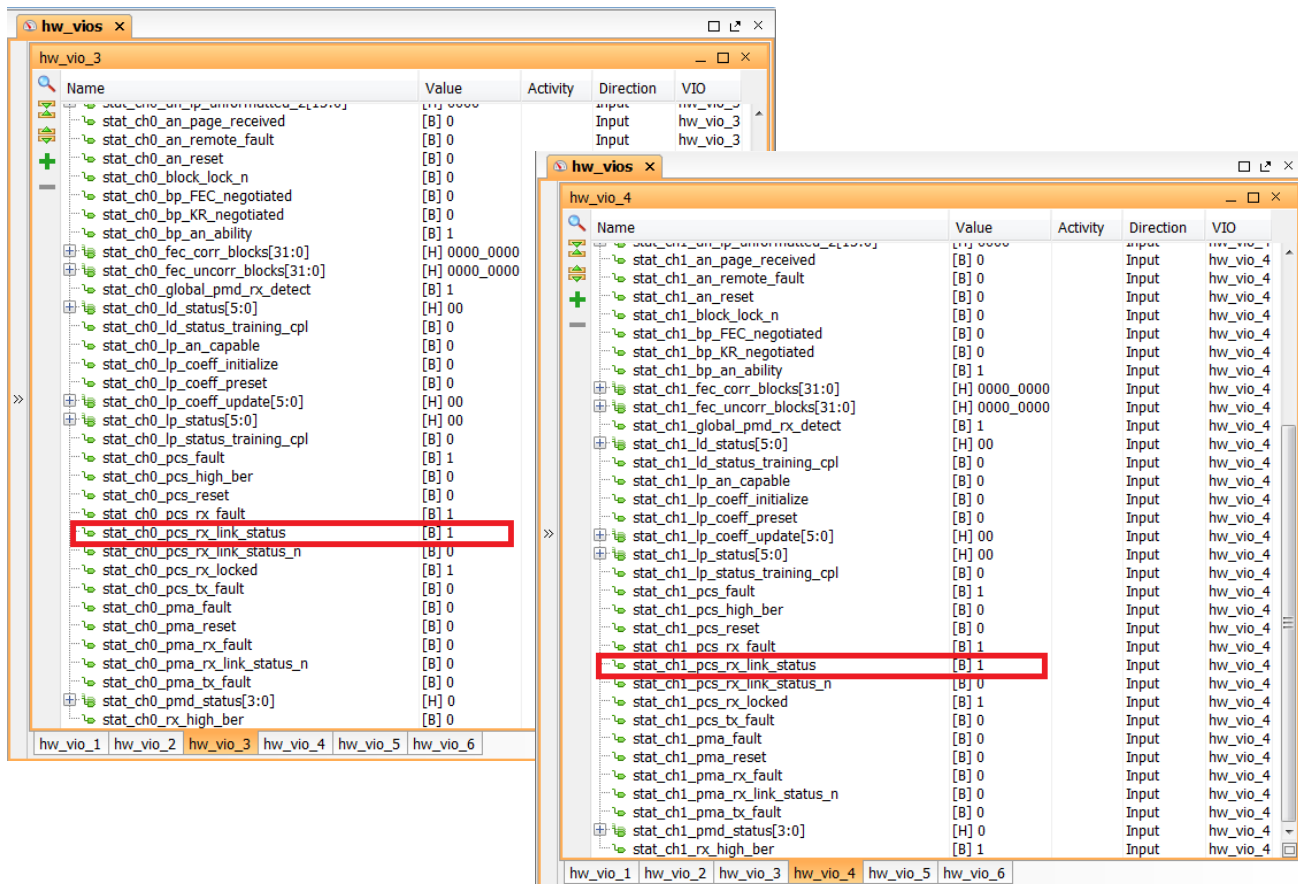

X18449-120716

Figure 3-9: Verify Link Status

- Enable FEC, Training and Auto Negotiation on both channels by configuring signals in the `ch0_*` and `ch1_*` VIO windows. Here is the sequence to follow:
 - Advertise Channel 1 is KR capable:
Set value 0080 on `ch1_an_adv_data_31_16`
 - Advertise Channel 1 supports FEC and is requesting FEC support from the partner:
Set value C000 on `ch1_an_adv_data_47_32`
 - Pulse `ch1_an_ad` to load the AN data bits for Channel 1:
Set value 1 on `ch1_an_ad`
Set value 0 on `ch1_an_ad`
 - Advertise Channel 0 is KR capable:
Set value 0080 on `ch0_an_adv_data_31_16`
 - Advertise Channel 0 supports FEC and is requesting FEC support from the partner:
Set value C000 on `ch0_an_adv_data_47_32`

- f. Pulse ch0_an_ad to load the AN data bits for Channel 0:
Set value 1 on ch0_an_ad
Set value 0 on ch0_an_ad
- g. Enable FEC on channel 1:
Set value 1 on ch1_enable_fec
- h. Enable FEC on channel 0:
Set value 1 on ch0_enable_fec
- i. Set Training done to 1 on channel 1. This indicates to Training Algorithm that the LP transmitter has been successfully trained:
Set value 1 on ch1_training_done
- j. Enable Training on channel 1:
Set value 1 on ch1_enable_training



IMPORTANT: Due to strict timing requirements on ch1_training_done, and the slow nature of executing Tcl commands in Vivado, the ch1_training_done command is executed before the ch1_enable_training command. This might not be true if executing these commands from a microprocessor.

- k. Set Training done to 1 on channel 0. This indicates to the Training Algorithm that the LP transmitter has been successfully trained:
Set value 1 on ch0_training_done
- l. Enable Training on channel 0:
Set value 1 on ch0_enable_training



IMPORTANT: Due to strict timing requirements on ch0_training_done, and the slow nature of executing Tcl commands in Vivado, the ch0_training_done command is executed before ch0_enable_training command. This may not be true if executing these commands from a microprocessor.

- m. Enable Auto Negotiation on channel 1:
Set value 1 on ch1_en_auto_negotiation
- n. Enable Auto Negotiation on channel 0:
Set value 1 on ch0_en_auto_negotiation
- o. Pulse Reset Auto Negotiation on channel 1:
Set value 1 on ch1_reset_autonegotiation, and then
Set value 0 on ch1_reset_autonegotiation



IMPORTANT: Only reset one side of the channel. In this example, only Channel 1 is reset.

To toggle the VIO signals in the sequence as described in [step 6](#) a Tcl script is provided in:

```
<working_dir>/kcu1250_10gbasekr_trd/ready_to_test/en_fec_tr_an.tcl
```

Source the script in the Tcl console of the Vivado IDE as shown in Figure 3-10.

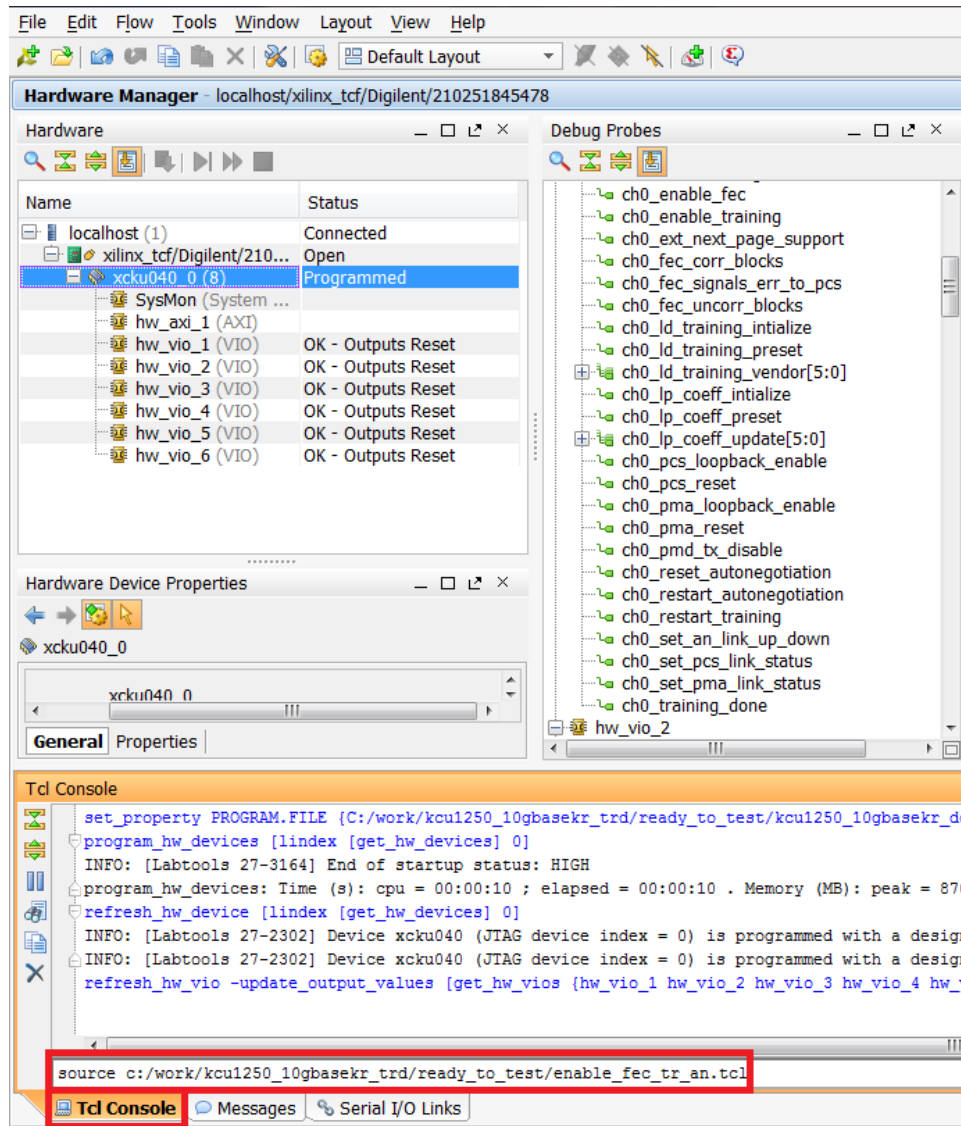

X18450-120716

Figure 3-10: Source enable_fec_tr_an.tcl

Verify if Auto Negotiation is complete (an_complete) and the 10GBASE-KR is negotiated successfully in the stat_ch0* and stat_ch1* VIO windows (Figure 3-11). It should take only a second or two for 10GBASE-KR IP core to negotiate successfully after executing the script.

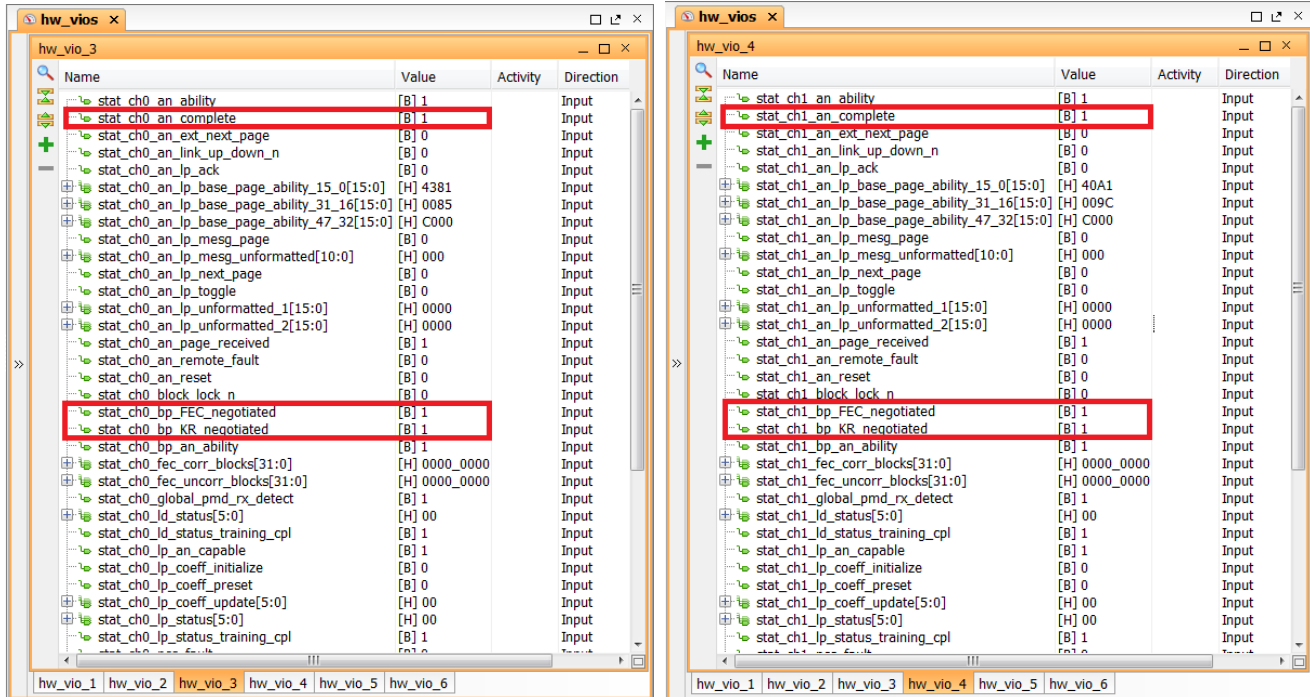

X18451-120716

Figure 3-11: AN Complete and KR Negotiated

Running the Design

Launch the Ethernet Controller Application

1. Launch the Ethernet Controller application GUI on the control computer. In Windows, click **Start > All Programs > Xilinx > EthernetController** (Figure 3-12).

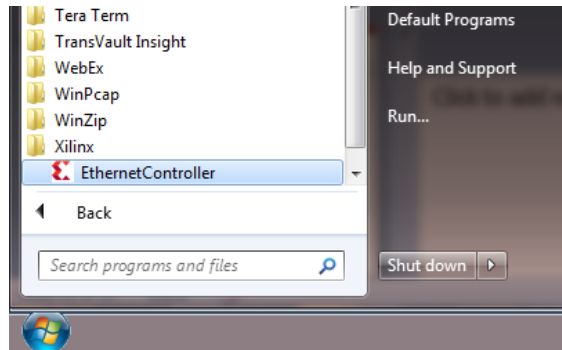

X18452-120716

Figure 3-12: Launch Ethernet Controller Application

2. Select the COM port associated with the Silicon Labs CP210x USB-to-UART Bridge: Standard COM Port and click **Connect** (Figure 3-13) to open the Ethernet Controller application for the 10GBASE-KR TRD.



TIP: The COM port associated with the Silicon Labs CP210x USB-to-UART Bridge: Standard COM Port can be identified using the Windows device manager. See [step 4, page 13](#).

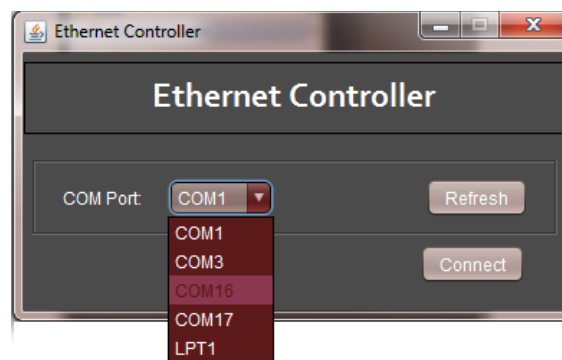

X18453-120716

Figure 3-13: Select COM Port Associated with the USB-to-UART Bridge

Running the Traffic Generators

1. Ethernet channel 0 and channel 1 are up and ready when the ETH0 PHY and ETH1 PHY indicators are green (Figure 3-14). In the control panel for both channel 0 and channel 1, select **Internal Generator** and enter **1500** in the payload field. Click **Start**.

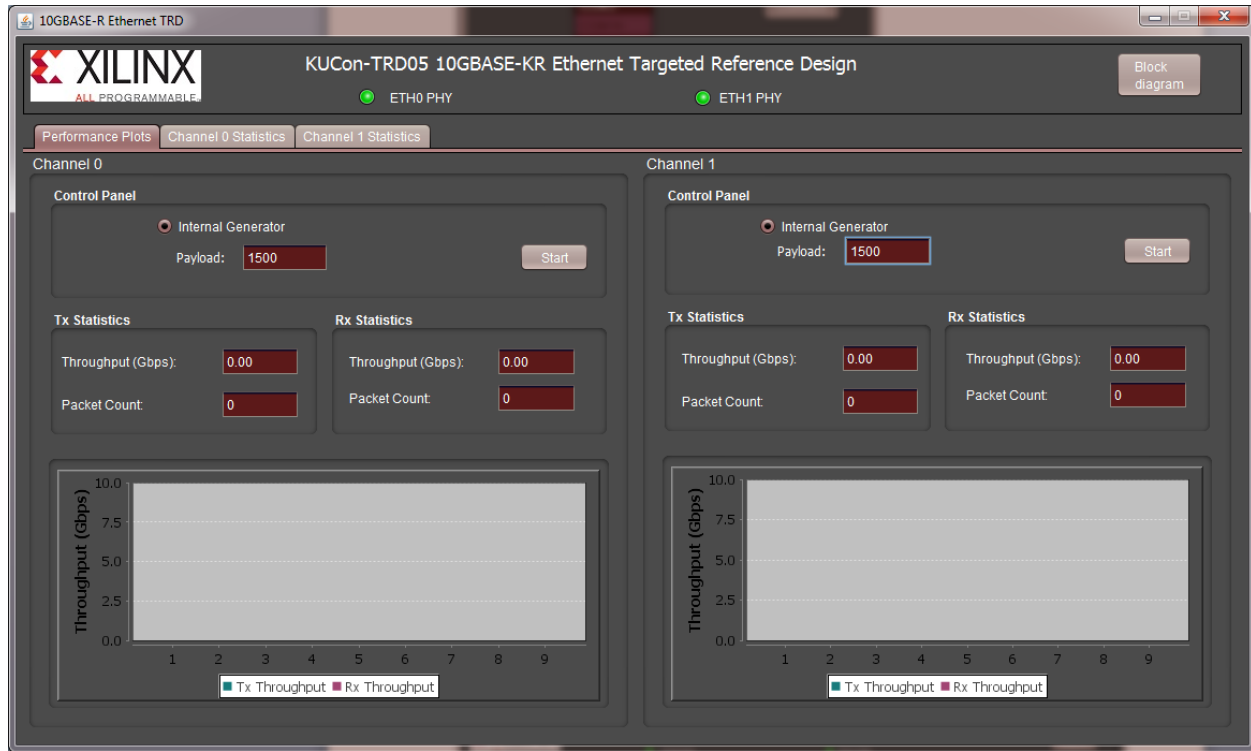

X18454-120716

Figure 3-14: Set Payload Size on Channel 0 and Channel 1

Figure 3-15 shows the performance achieved at this payload size is 9.74 Gb/s per channel per direction. The allowed payload values that can be entered are 46 bytes to 1,500 bytes.

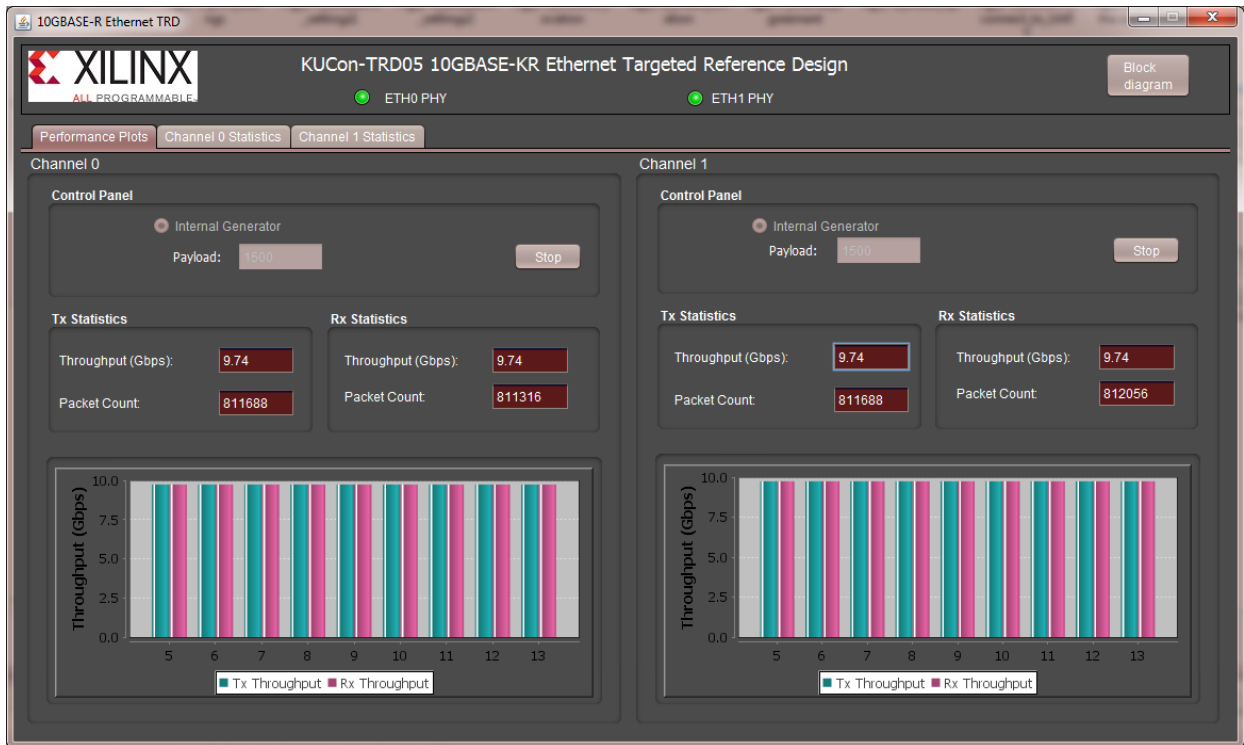

X18455-120716

Figure 3-15: Throughput Performance Plots



TIP: The relationship between payload size and throughput can be demonstrated by changing the payload size. Reducing the payload size causes a dip in performance. Refer to [Appendix B, Performance Estimates](#) for performance estimation on 10G Ethernet protocol.

2. Stop traffic generation by clicking **Stop** for both channels.

3. Select the **Channel 0 Statistics** tab and verify if any packets were in error or were dropped (Figure 3-16).

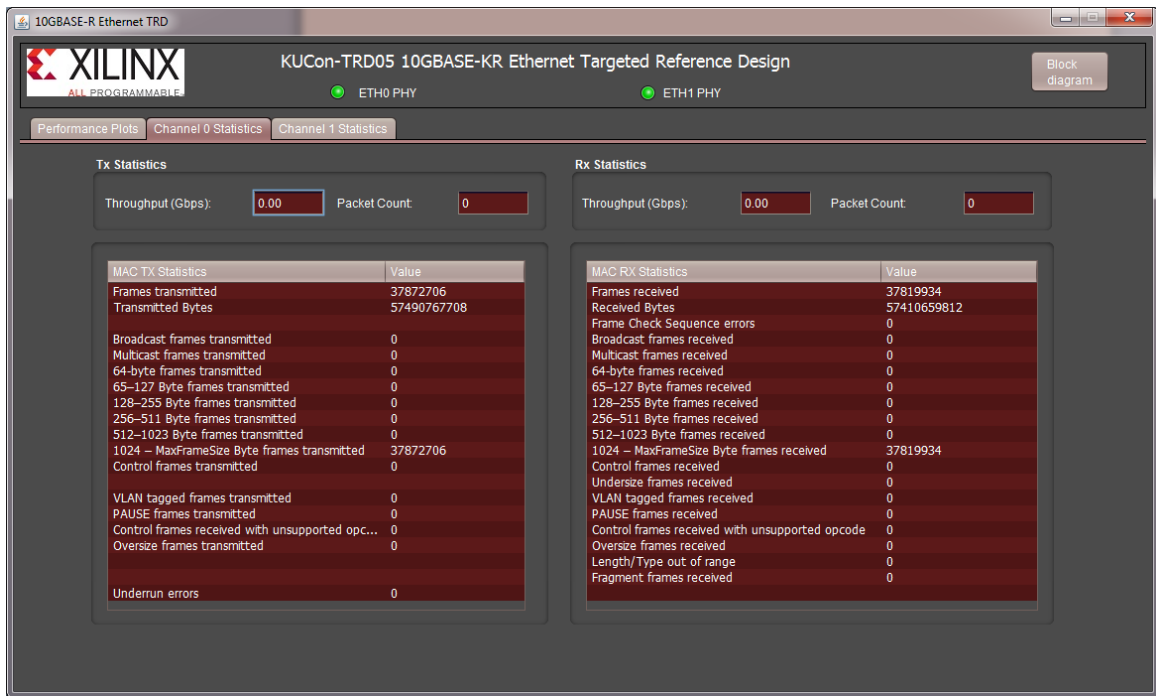

X18456-120716

Figure 3-16: Channel 0 MAC Statistics

4. Next, select the **Channel 1 Statistics** tab and verify if any packets were in error or were dropped (Figure 3-17):
 - The TX MAC statistics for Channel 0 should match the RX MAC statistics of Channel 1.
 - The TX MAC statistics for Channel 1 should match the RX MAC statistics of Channel 0.

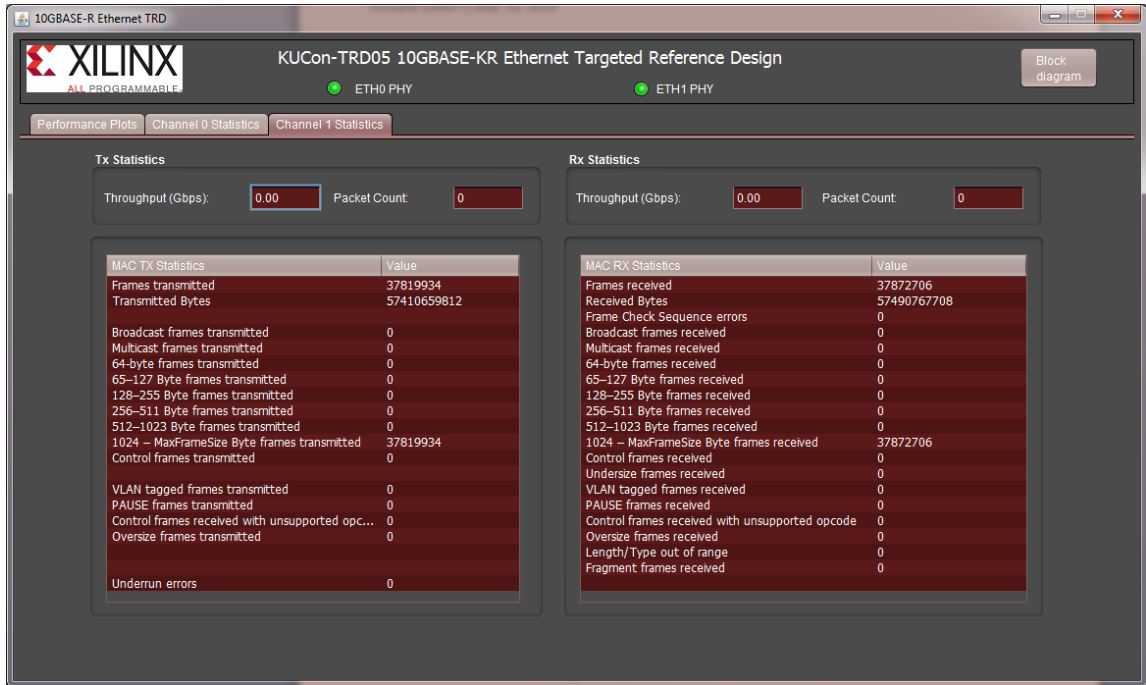

X18457-120716

Figure 3-17: Channel 1 MAC Statistics

5. Select the **Performance Plots** tab. Click **Start** for both channels to enable traffic generation again. Run the instructions in the [Generate Eye Scans](#) section with traffic running.

Generate Eye Scans

The JTAG to AXI Master IP core (hw_axi_1) allows the Vivado logic analyzer Tcl console running on the control computer to interact with FPGA through the USB-to-JTAG port (U80) on the KCU1250 board. The control computer periodically reads data samples via hw_axi_1 and creates an eye scan.

For more details refer to *In-System Eye Scan of a PCI Express Link with Vivado IP Integrator and AXI4 Application Note* (XAPP1198) [\[Ref 14\]](#).

To generate an eye scan:

1. With traffic running in the Ethernet Controller application, source the `run_eyescan.tcl` script in the Tcl console of the Vivado IDE ([Figure 3-18](#)). The command to source the script is:

```
source
<working_dir>/kcu1250_10gbasekr_trd/ready_to_test/eyescan/run_eyescan.tcl.
```



IMPORTANT: Do not disconnect the USB-to-JTAG connection. This connection is required for the control computer to interact with the JTAG to AXI Master IP core.

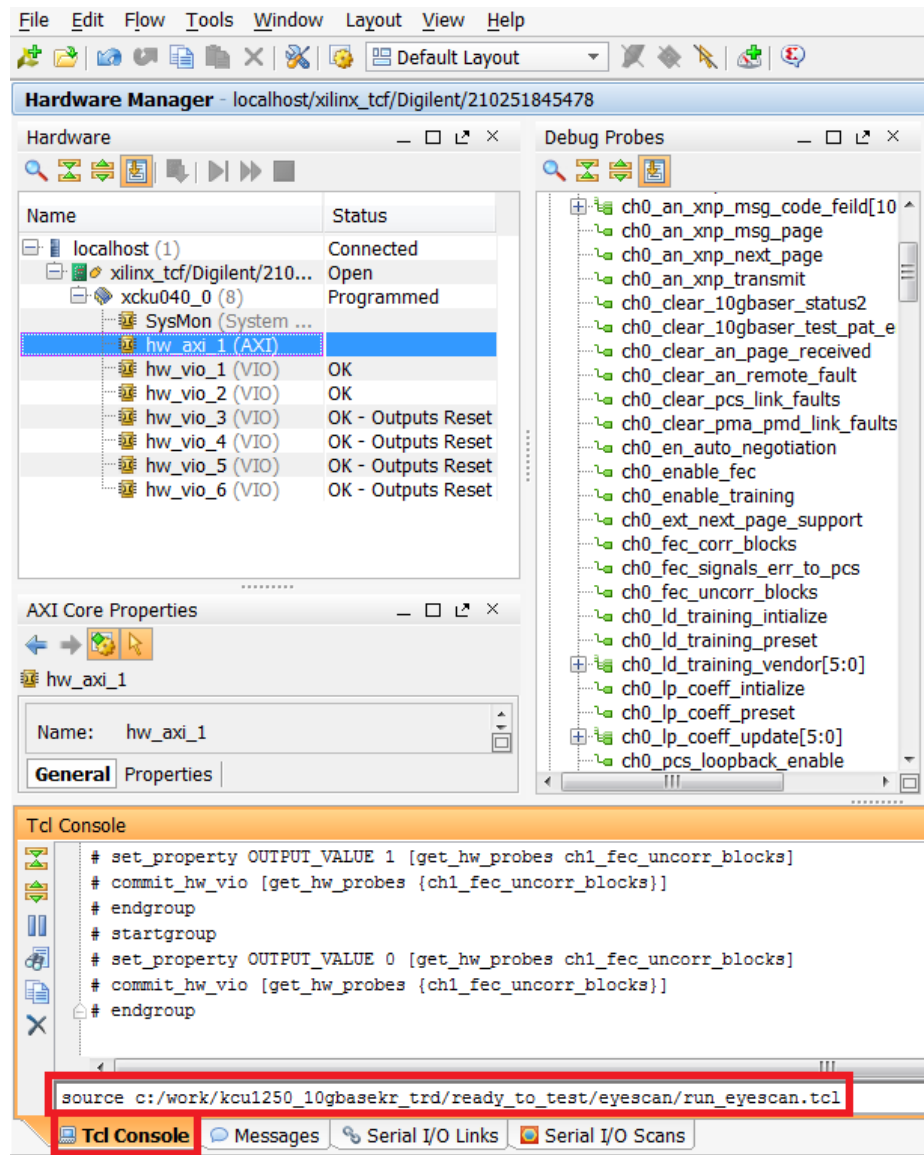

X18458-120716

Figure 3-18: Tcl Script run_eyescan.tcl

2. The `run_eyescan` command becomes available after the `run_eyescan.tcl` file is sourced. To initiate a scan, type `run_eyescan` in the Tcl console (Figure 3-19). This command initiates:
 - Vertical and Horizontal sweeps
 - Data sample collection
 - Data sample processing to create an eye scan

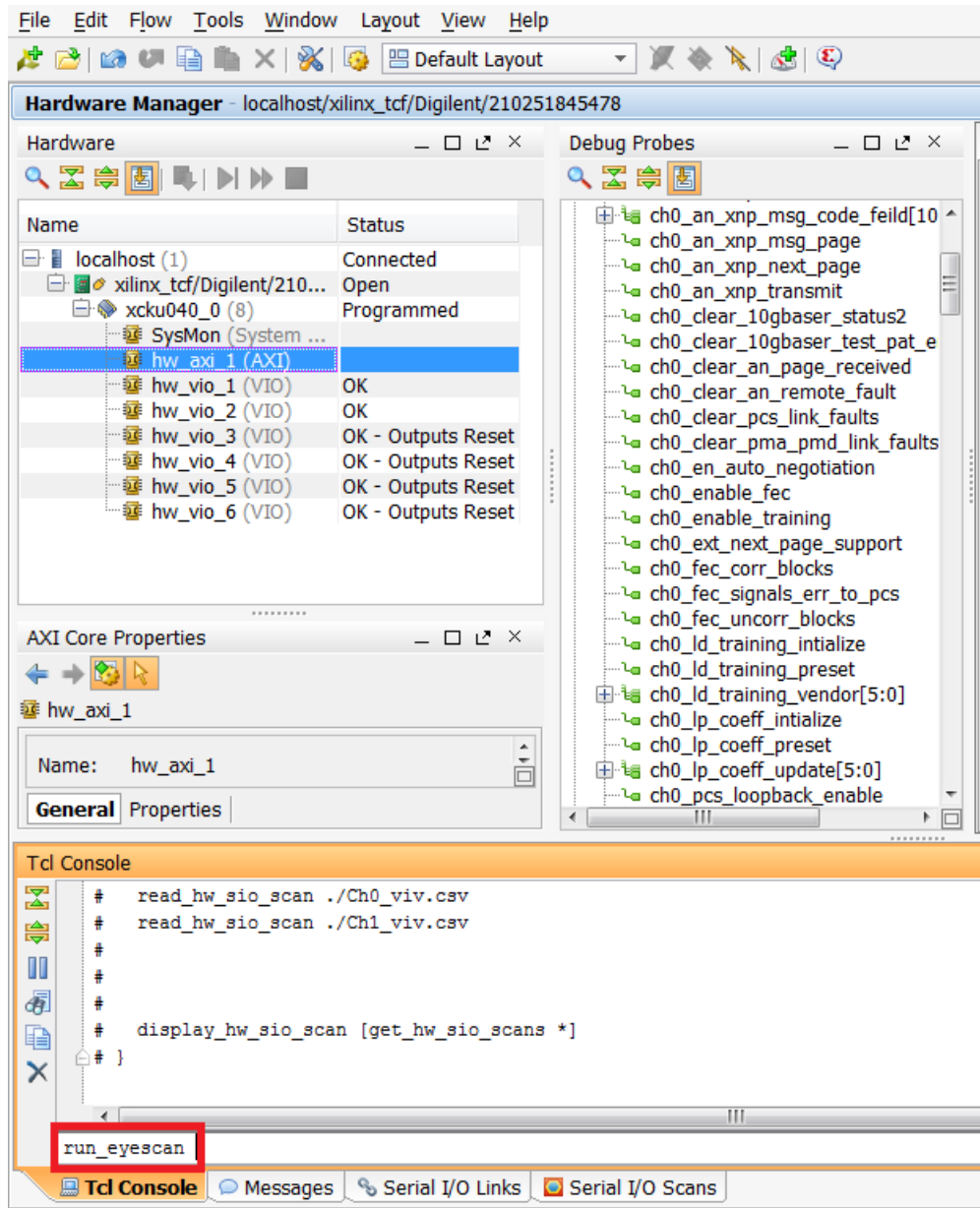

X18459-120716

Figure 3-19: The `run_eyescan` Command

3. The scan plots for Channel 0 and Channel 1 are shown in Figure 3-20.



NOTE: The Scan Plot for Channel 0 was dragged to a new Vertical group.

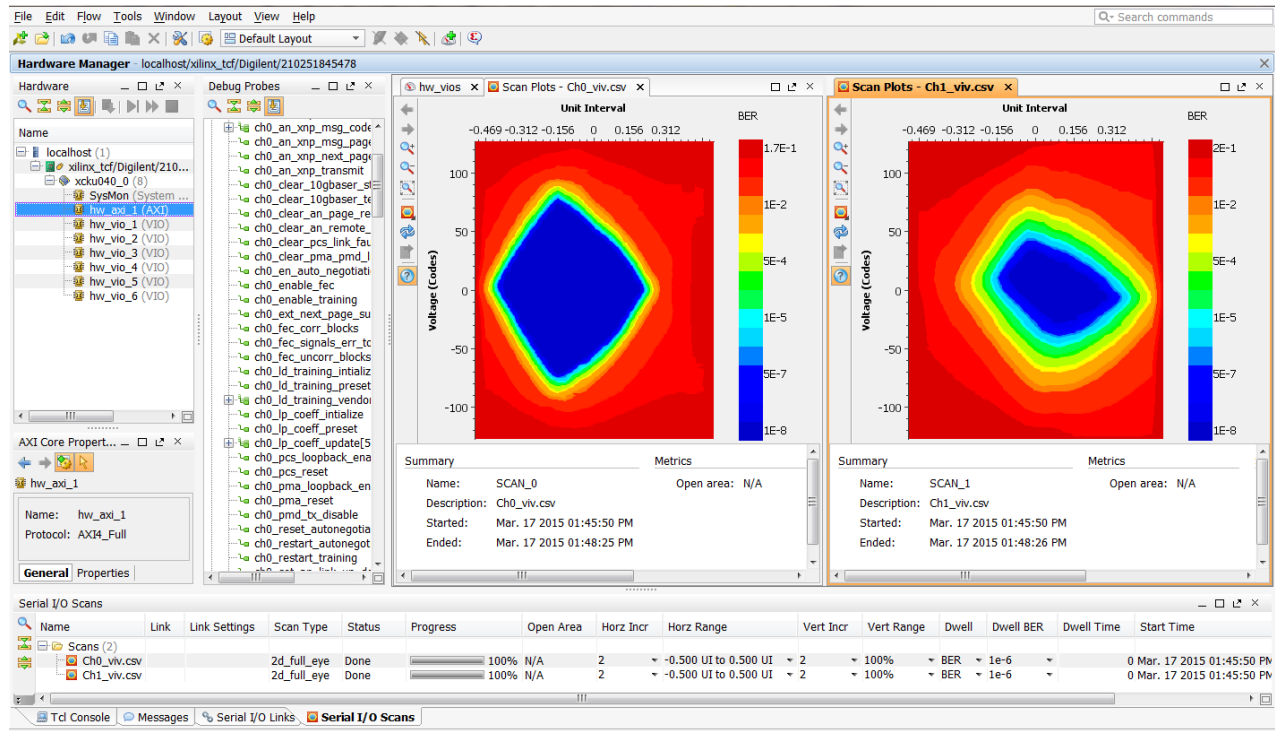

X18460-120716

Figure 3-20: Eye Scan for Channel 0 and Channel 1

Forward Error Correction

To showcase forward error correction, a 10-Gigabit Ethernet PCS/PMA IP file has been modified to inject errors in the GTH transceiver parallel data via VIO. The unmodified file is located at:

```
<working_directory>/kcu1250_10gbase_kr/hardware/vivado/runs/impl_run/10gbasekr_trd.srscs/sources_1/bd/mac_phy/ip/mac_phy_ten_gig_eth_pcs_pma_ch0_0/synth/mac_phy_ten_gig_eth_pcs_pma_ch0_0_block.v
```

A demo BIT file is provided with the 10GBASE-KR TRD to inject errors and verify if the Forward Error Correction (FEC) block is working as expected.

To program the FPGA with this demo:

1. Repeat [Set Up the KCU1250 Board](#).

2. Repeat [Program the Clocks Sources](#).
3. Repeat [step 1, page 23](#) and [step 2, page 24](#) listed under [Program the FPGA](#).
4. Program the FPGA:
 - a. In the **Bitstream file** field, browse to the location of the BIT file:

```
<working_dir>/kcu1250_10gbasekr_trd/ready_to_test/fec_and_err_injection/kcu1250_10gbasekr_download.bit
```
 - b. In the **Debug Probes file** field, browse to the location of the LTX file:

```
<working_dir>/kcu1250_10gbasekr_trd/ready_to_test/fec_and_err_injection/debug_nets.ltx
```
 - c. Click **Program** ([Figure 3-21](#)).

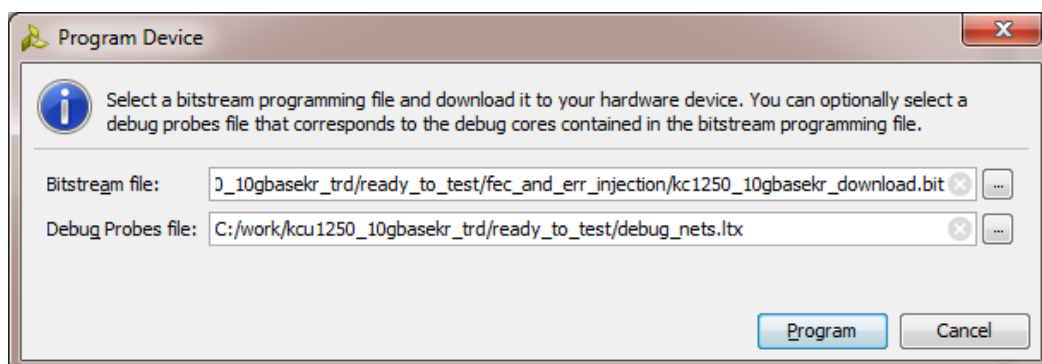

X18461-120716

Figure 3-21: Program Device Window

There are seven VIO cores in the reference design. After programming, they can be controlled in the Vivado IDE. To add probes to each VIO window:

1. Open the VIO dashboard. On the top panel of the Vivado IDE, click **Window > Dashboard > Reset to default**.
2. Open the Debug Probes window: on the top panel of the Vivado IDE click **Window > Debug Probes**.
3. In the Debug Probes window, right click on **hw_vio_1** and select **Add probes to VIO Window**.
4. Repeat the same procedure for **hw_vio_2**, **hw_vio_3**, **hw_vio_4**, **hw_vio_5**, **hw_vio_6**, and **hw_vio_7**.

Table 3-2 shows what each VIO dashboard configures and monitors.

Table 3-2: VIO Dashboard Mapping for the FEC and Error Injection BIT File

VIO Dashboard	Mapping	Comments
hw_vio_7 ⁽¹⁾	training_*_ch1	Configures the DRP port for channel 1 through the training port of 10G Ethernet PCS-PMA IP.
hw_vio_6 ⁽¹⁾	training_*_ch0	Configures the DRP port for channel 0 through the training port of 10G Ethernet PCS-PMA IP.
hw_vio_5 ⁽¹⁾	stat_ch1_*	Monitors the status vector signals of 10G Ethernet PCS-PMA IP for channel 1.
hw_vio_4 ⁽¹⁾	stat_ch0_*	Monitors the status vector signals of 10G Ethernet PCS-PMA IP for channel 0.
hw_vio_3 ⁽¹⁾	ch1_*	Configures the configuration vector signals of 10G Ethernet PCS-PMA IP for channel 1.
hw_vio_2 ⁽¹⁾	ch0_*	Configures the configuration vector signals of 10G Ethernet PCS-PMA IP for channel 0.
hw_vio_1 ⁽¹⁾	insert_*_bit_error_*	Allows insertion of bit errors in transmit and receive data streams of Channel 0.

Notes:

1. The value of n in hw_vio_n might change based on how the Vivado Synthesis tool processes the netlist. You might have to redo the above mapping accordingly.
5. Verify if stat_ch0_pcs_rx_link_status and stat_ch1_pcs_rx_link_status is 1. This indicates that the 10GBASE-R link is up.
6. Enter the following Tcl script in the Vivado IDE to enable FEC, Training and Auto Negotiation on both channels:

```
source <working_dir>/kcu1250_10gbasekr_trd/ready_to_test/enable_fec_tr_an.tcl
```
7. Verify if Auto Negotiation is complete (stat_ch*_an_complete) and 10GBASE-KR is negotiated successfully (stat_ch*_bp_KR_negotiated) in stat_ch0* and stat_ch1* VIO windows.
8. Repeat the steps in [Running the Design](#).
9. In the ch1_* and ch0_* VIO windows, follow this sequence to insert errors in the data stream:
 - a. In the ch1_* and ch0_* windows:
 - Toggle (0 > 1 > 0) ch1_fec_corr_blocks
 - Toggle (0 > 1 > 0) ch1_fec_uncorr_blocks
 - Toggle (0 > 1 > 0) ch0_fec_corr_blocks
 - Toggle (0 > 1 > 0) ch0_fec_uncorr_blocks

This clears the `stat_ch*_fec_corr_blocks` and `stat_ch*_fec_uncorr_blocks` in the `stat_ch1_*` and `stat_ch0_*` VIO windows.

- b. In the `insert*_bit_error_*` VIO window:
 - Toggle (0 > 1 > 0) `insert_single_bit_error_rx`
 - Verify the `stat_ch0_fec_corr_blocks` count goes up. Each toggle increases the count value by 1.
- c. In the `insert*_bit_error_*` VIO window:
 - Toggle (0 > 1 > 0) `insert_single_bit_error_tx`
 - Verify the `stat_ch1_fec_corr_blocks` count goes up. Each toggle increases the count value by 1.
- d. In the Ethernet Controller application, click **Stop** and verify channel 0 MAC statistics and channel 1 MAC statistics for errors or packet drops. There should be none.
- e. In the Ethernet Controller application, click **Start** to enable traffic generation on channel 0 and channel 1.
- f. In the `insert*_bit_error_*` VIO window,
 - Set `insert_multi_bit_rx_vector` to `h'FFF`. This signal allows you to set the number of bits which are in error in succession. A value of `h'FFF` indicates a burst of 12 bit errors.
 - Toggle (0 > 1 > 0) `insert_multi_bit_error_rx`.
 - Verify the `stat_ch0_fec_uncorr_blocks` count goes up. Each toggle increases the count value by one.



IMPORTANT: *If the number of contiguous '1' bits in the `insert_multi_bit_rx_vector` is set to less than 12, then `stat_ch0_fec_corr_blocks` count goes up since the FEC block is capable of correcting a burst of 11 error bits.*

- g. In the `insert*_bit_error_*` VIO window,
 - Toggle (0 > 1 > 0) `insert_multi_bit_error_tx`. This signal causes a burst of 12 errors on the transmit data.
 - Verify the `stat_ch1_fec_uncorr_blocks` count goes up. Each toggle increases the count value by one.
- h. In the Ethernet Controller application, click on Stop and verify Channel 0 MAC statistics and Channel 1 MAC statistics for errors or packet drops. There will be errors and the Frames Received count on the channels will not match up.

To execute the sequence as described in [step 9](#), a Tcl script is provided. Source the script in the Tcl console of the Vivado IDE with the traffic running in the Ethernet Controller application. The command to source the script is:

```
source
<working_dir>/kcu1250_10gbasekr_trd/ready_to_test/fec_and_err_injection/err_in
jection.tcl
```

Dynamic Reconfiguration Ports

The GTH transceiver dynamic reconfiguration ports (DRP) can be accessed via the training ports of the 10-Gigabit Ethernet PCS/PMA IP core. The training ports are brought out to VIOs - training_*_ch0 and training_*_ch1.

1. For reads:

- Set the training_addr_ch* to a DRP address, example h'00_007F (TX_MARGIN_FULL_1, TX_MARGIN_FULL_0)
- Set the training_rnw_ch* to 1
- Toggle (0 > 1 > 0) enable_ch*
- The read value will be available on training_rd_data_reg_ch*

2. For writes:

- Set the training_addr_ch* to a DRP address example h'00_007F (TX_MARGIN_FULL_1, TX_MARGIN_FULL_0)
- Set the training_wr_data for the above address as h'AE9C
- Set the training_rnw_ch* to 0
- Toggle (0 > 1 > 0) enable_ch*
- Read the value back following the instructions for Reads to verify that the write was successful

To execute the sequence described in [step 1](#) and [step 2](#), A Tcl script is provided in:

```
<working_dir>/kcu1250_10gbasekr_trd/ready_to_test/drp_rd_wr.tcl
```

Source the script in the Tcl console of the Vivado IDE.

Refer to *UltraScale Architecture GTH Transceivers User Guide* (UG576) [[Ref 15](#)] for a list of DRP addresses that can be accessed.

Implementing and Simulating the Design

This chapter describes how to implement and simulate the 10GBASE-KR TRD.

Implementing the Design

The 10GBASE-KR TRD is implemented using Vivado® Design Suite.

Download the Reference Design Files

See [Download Targeted Reference Design Files](#) for instructions.



TIP: The Reference Design directory structure is described in [Appendix A, Directory Structure](#).



IMPORTANT: The 10-Gigabit Ethernet MAC IP core (10G MAC) requires a license to build the design. Obtain the license at the 10 Gigabit Ethernet Media Access Controller (10GEMAC) website [\[Ref 16\]](#). Click **Evaluate** or **Order** to access the license.



IMPORTANT: The 10-Gigabit Ethernet PCS/PMA IP core (10GBASE-KR) requires a license to build the design. Obtain the license at the 10 Gigabit Ethernet PCS/PMA with FEC/Auto-Negotiation (10GBASE-KR) website [\[Ref 17\]](#). Click **Evaluate** or **Order** to access the license.

Generate the Hardware Bitstream

The reference design can be implemented or simulated on a Windows 7 or a Linux computer. The computer should have Vivado Design Suite 2017.3 installed on it.

1. Launch the Vivado Integrated Design Environment (IDE) and set up the reference design project.

- In Windows 7:

Click **Start > All Programs > Xilinx Design Tools > Vivado 2017.3 > Vivado 2017.3**.

- a. In the Tcl console type:

```
cd <working_dir>/kcu1250_10gbasekr_trd/hardware/vivado  
source scripts/kcu1250_10GBASEKR_trd.tcl
```

- On Linux:

- a. On a terminal window, change the directory to:

```
<working_dir>/kcu1250_10gbasekr_trd/hardware/vivado
```

- b. At the command prompt enter:

```
vivado -source scripts/kcu1250_10GBASEKR_trd.tcl
```

The Vivado IDE will display the 10gbasekr_trd project populated with sources (Figure 4-1).



IMPORTANT: When building the design on Windows, if this error occurs: *Path Length Exceeds 260 Bytes maximum allowed by Windows*, move the *kc1250_10gbasekr_trd* directory directly under *C: *.

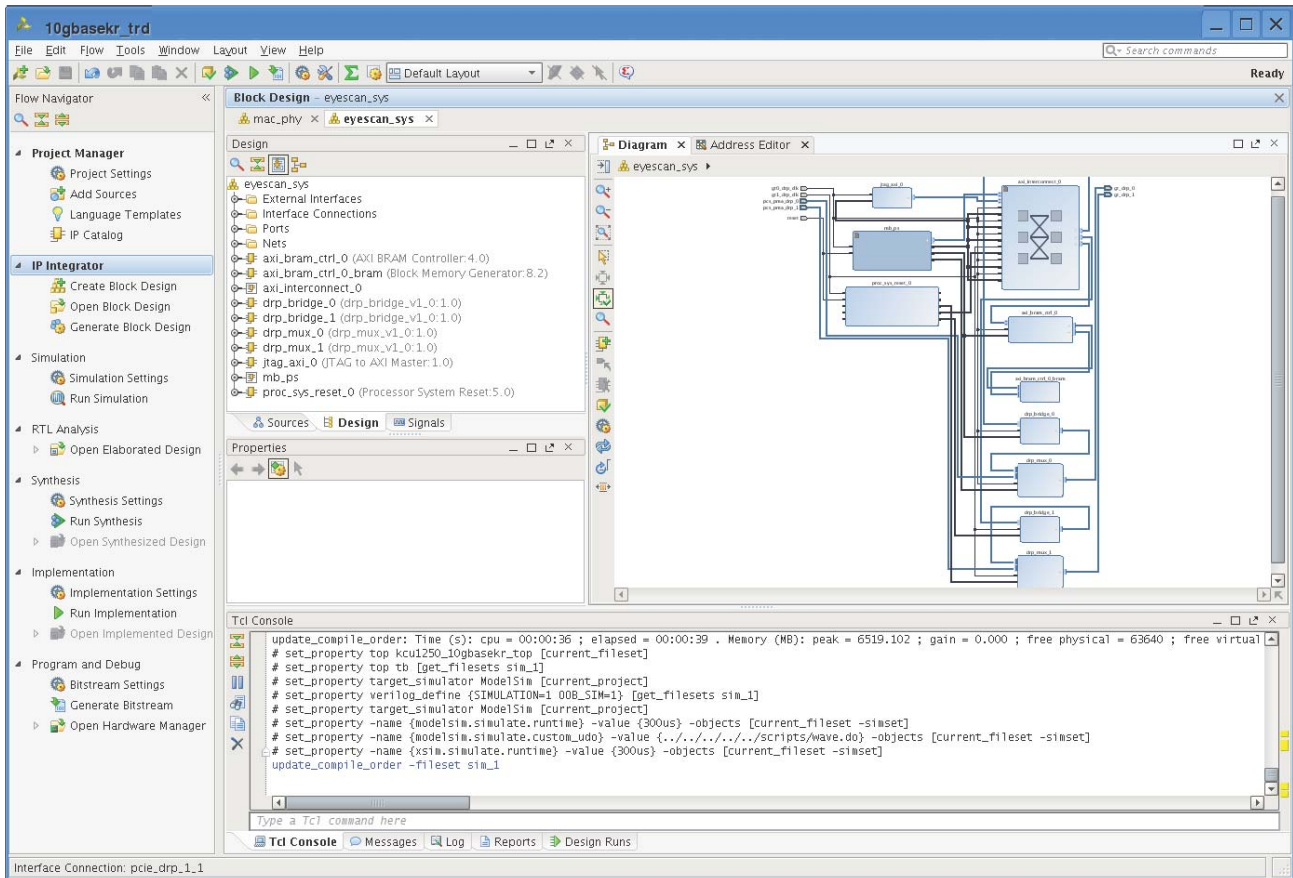

X18462-120716

Figure 4-1: 10GBASE-KR TRD Design Hierarchy

2. Select the **Sources** tab.

In the Hierarchy window, two IP Integrator (IPI) block designs are referenced (Figure 4-2). Block design *mac_phy.bd* contains the 10-Gigabit Ethernet MAC IP core (10G MAC), 10-Gigabit Ethernet PCS/PMA IP core (10GBASE-KR), the Traffic Generator and Monitor, and the MicroBlaze™ processor subsystem. Block design

eyescan_sys.bd contains the JTAG to AXI Master IP core, AXI BRAM Controller IP core, DRP to AXI bridge logic, and the MicroBlaze processor subsystem.

The design top level file kcu1250_10gbasekr_top.v instantiates the block designs. The top level file also instantiates the VIO cores to configure and monitor the 10-Gigabit Ethernet PCS/PMA IP core.

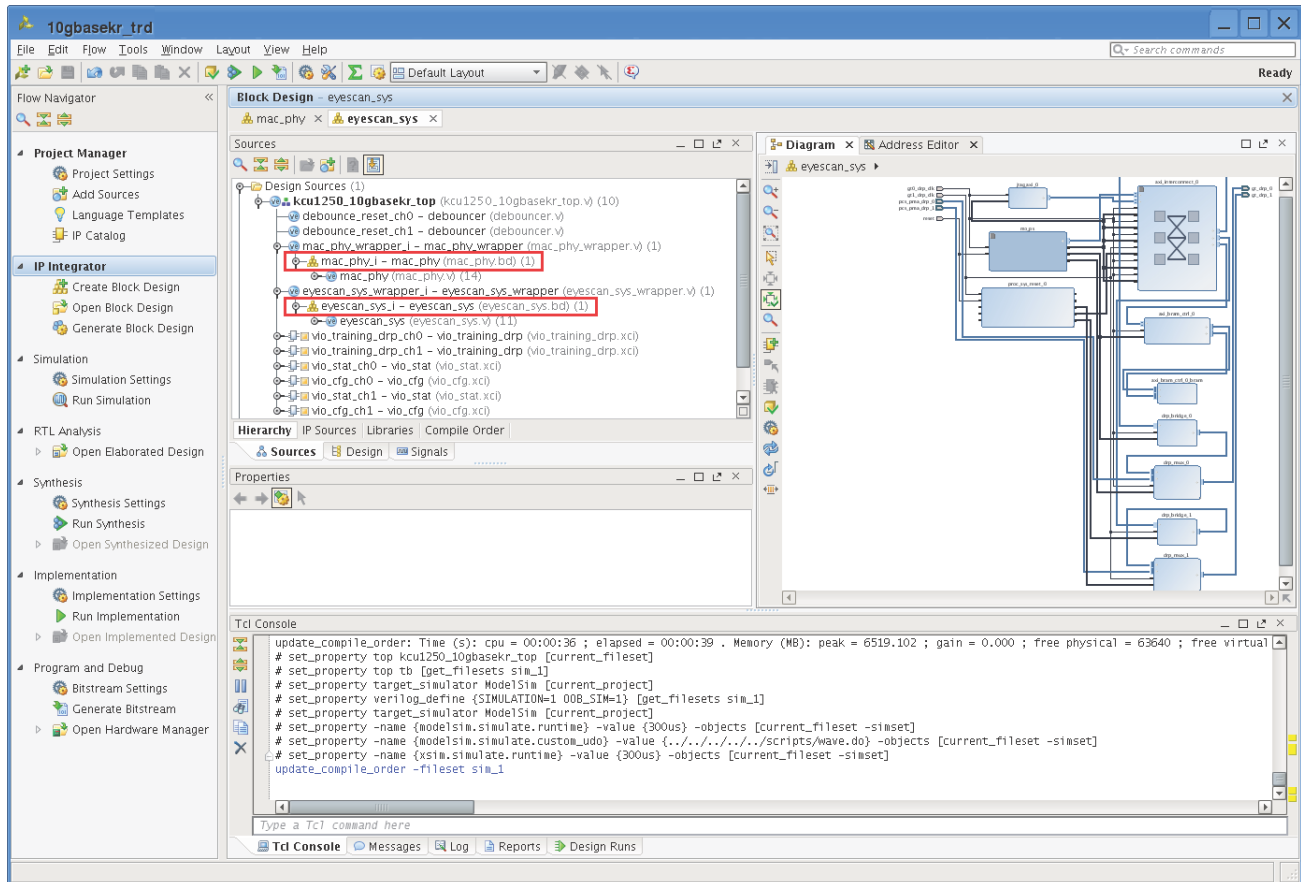

X18463-120716

Figure 4-2: Vivado Project, Sources View

3. In the Flow Navigator, click **Generate Bitstream**.
4. In the No Implementation Results Available window, click **Yes**. The bitstream will be generated and available at:
`<working_dir>/kcu1250_10gbasekr_trd/hardware/vivado/runs/impl_run/10gbasekr_trd.runs/impl_1/kcu1250_10gbasekr_top.bit.`



NOTE: It takes about an hour to build the bitstream.

Generate ELF File for the MicroBlaze Controller in mac_phy.bd

1. To generate the application (ELF file) to run on the MicroBlaze processor, the block design must be exported and built in the SDK. To launch SDK with the mac_phy block design exported, in the Tcl console type:

```
source scripts/launch_sdk_mac_phy.tcl (Figure 4-3).
```

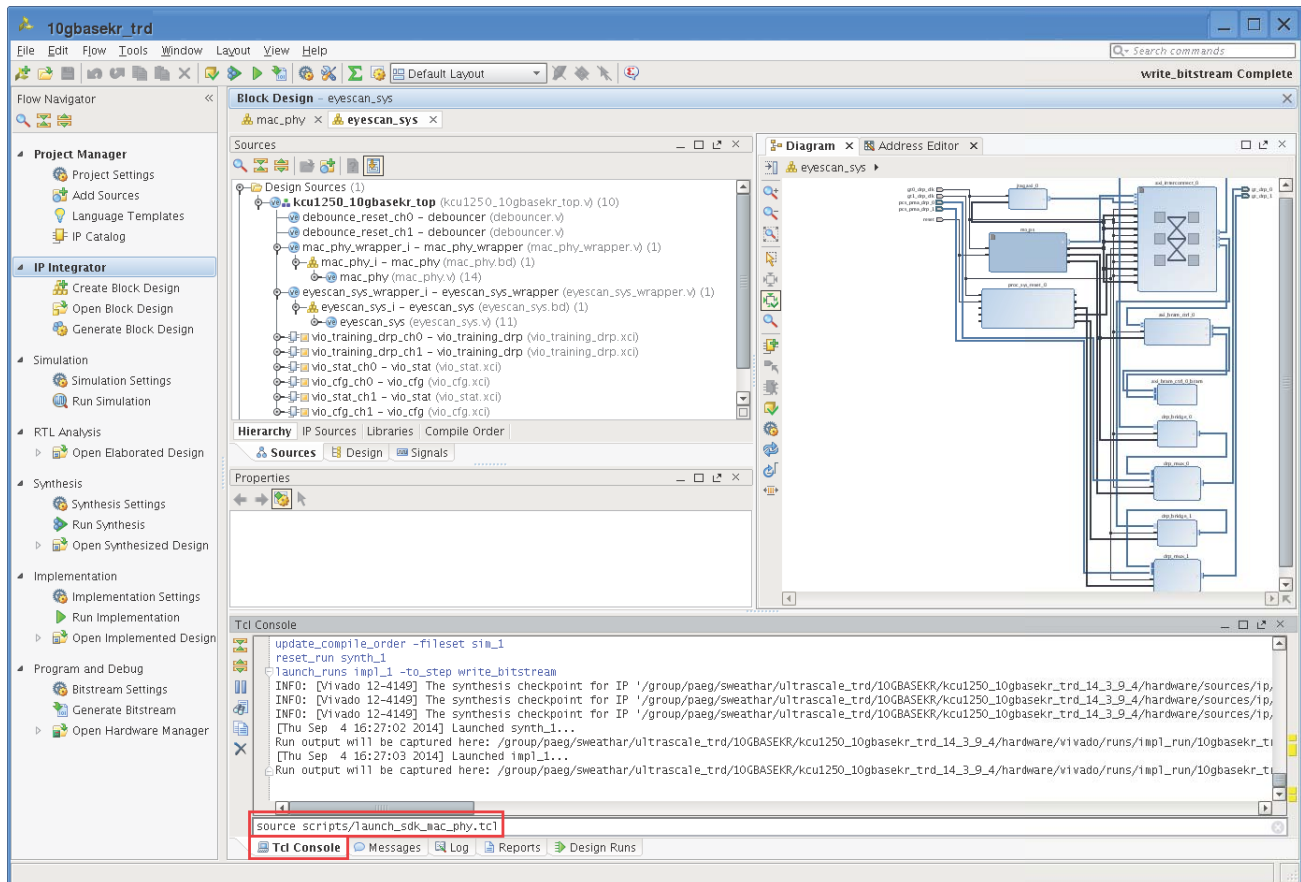

X18464-120716

Figure 4-3: Export Hardware to the SDK

- In the SDK window (Figure 4-4) select **File > New > Application Project** to build an application.

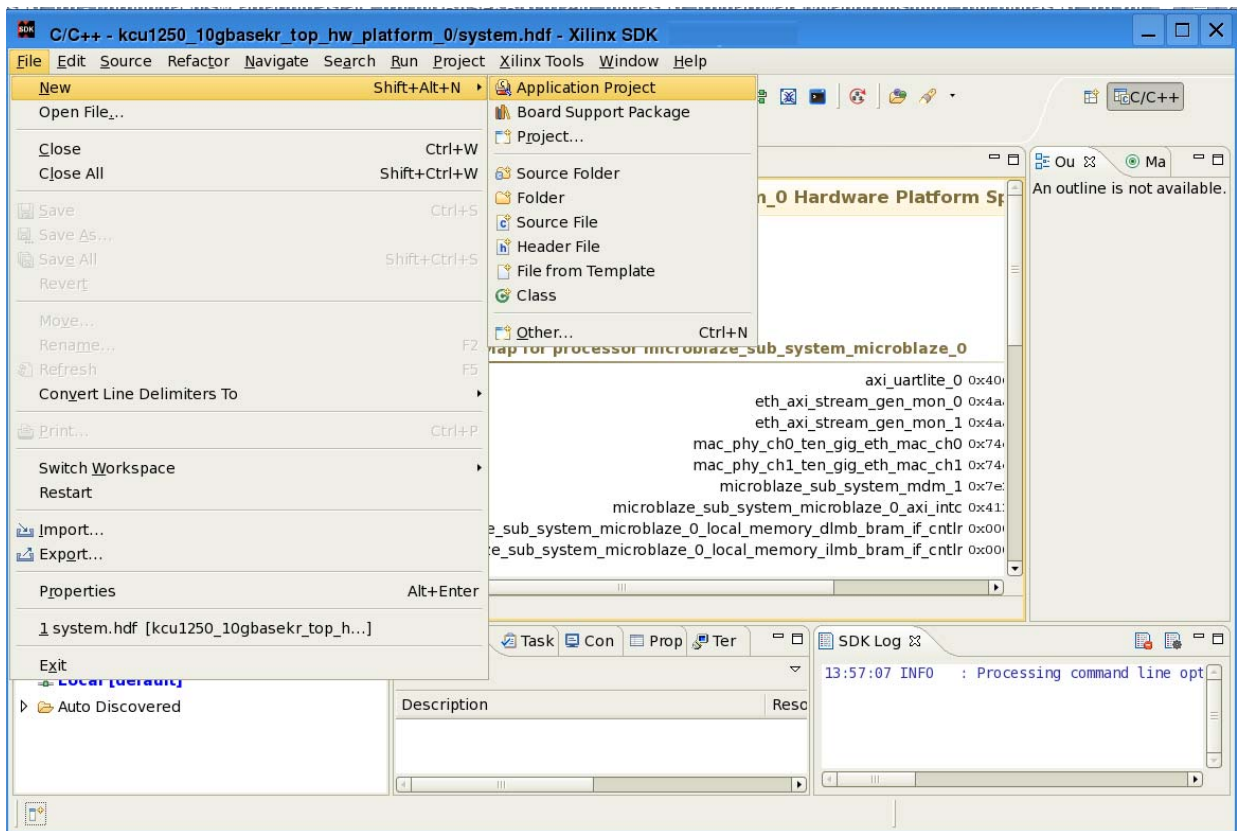

X18465-120716

Figure 4-4: Creating an Application Project in the SDK

3. In the Application Project window (Figure 4-5) enter the project name as **kcu1250_10gbasekr_top** and click **Next**.

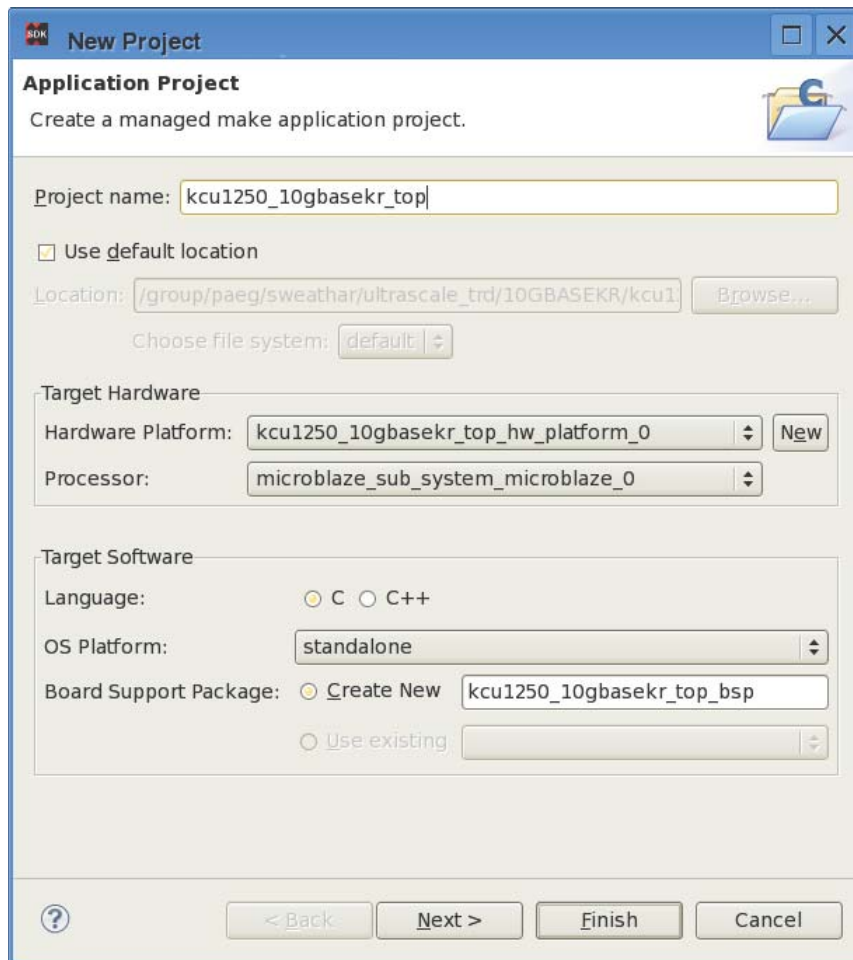

X18466-120716

Figure 4-5: Assign Project Name

4. Select **Empty Application** and click Finish (Figure 4-6).

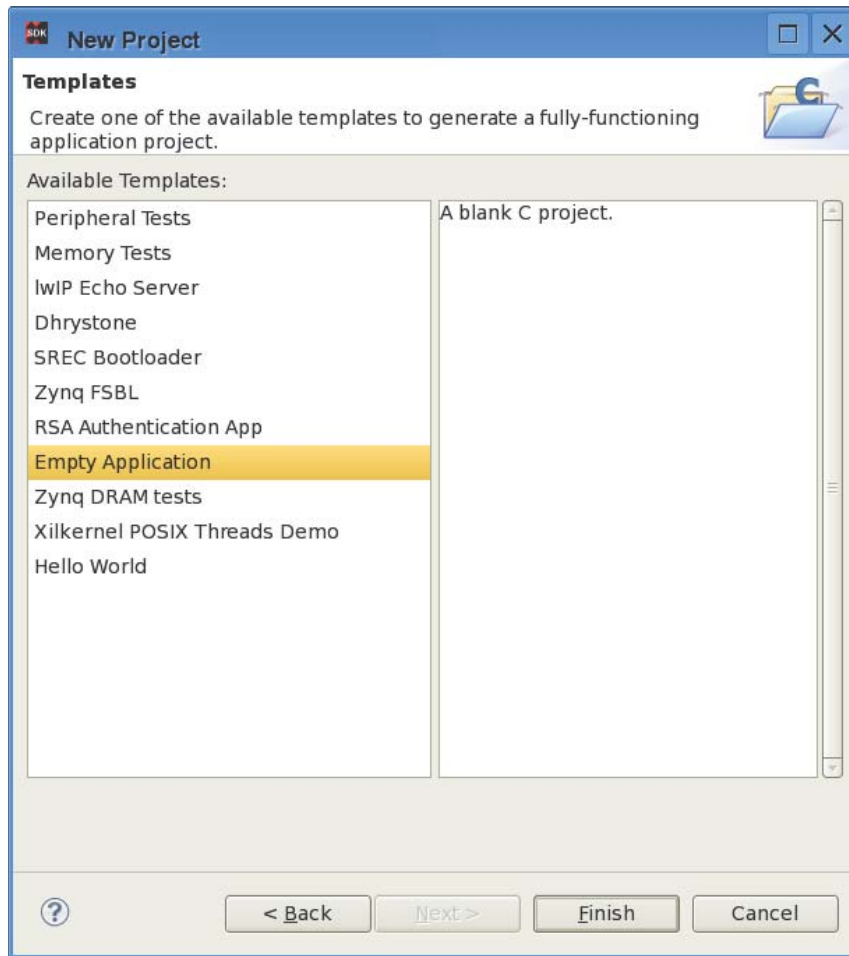

X18467-120716

Figure 4-6: Select Empty Application

- In the project explorer tab (Figure 4-7), right-click **kcu1250_10gbasekr_top**, select **Import**, and under the General tab select **File System**. Click **Next**.

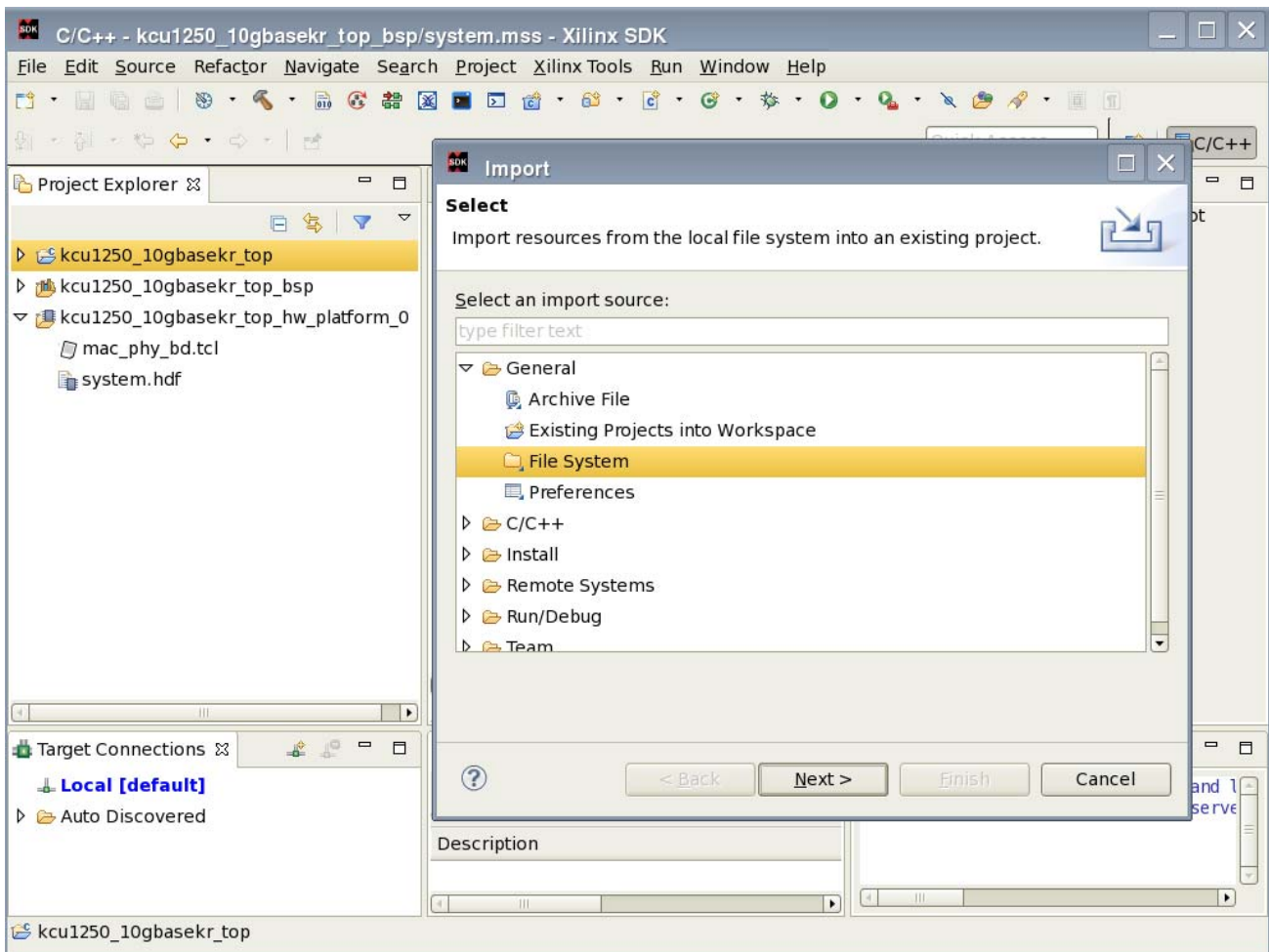

X18468-120716

Figure 4-7: Importing File System

6. Browse to source folder:

<working_dir>/kcu1250_10gbasekr_trd/software/source.

Select the source directory in the left pane and click **Finish** (Figure 4-8).

The application ELF file will be generated and available at:

<working_dir>/kcu1250_10gbasekr_trd/hardware/vivado/runs/impl_run/10gbasekr_trd.sdk/mac_phy/kcu1250_10gbasekr_top/Debug/kcu1250_10gbasekr_top.elf.

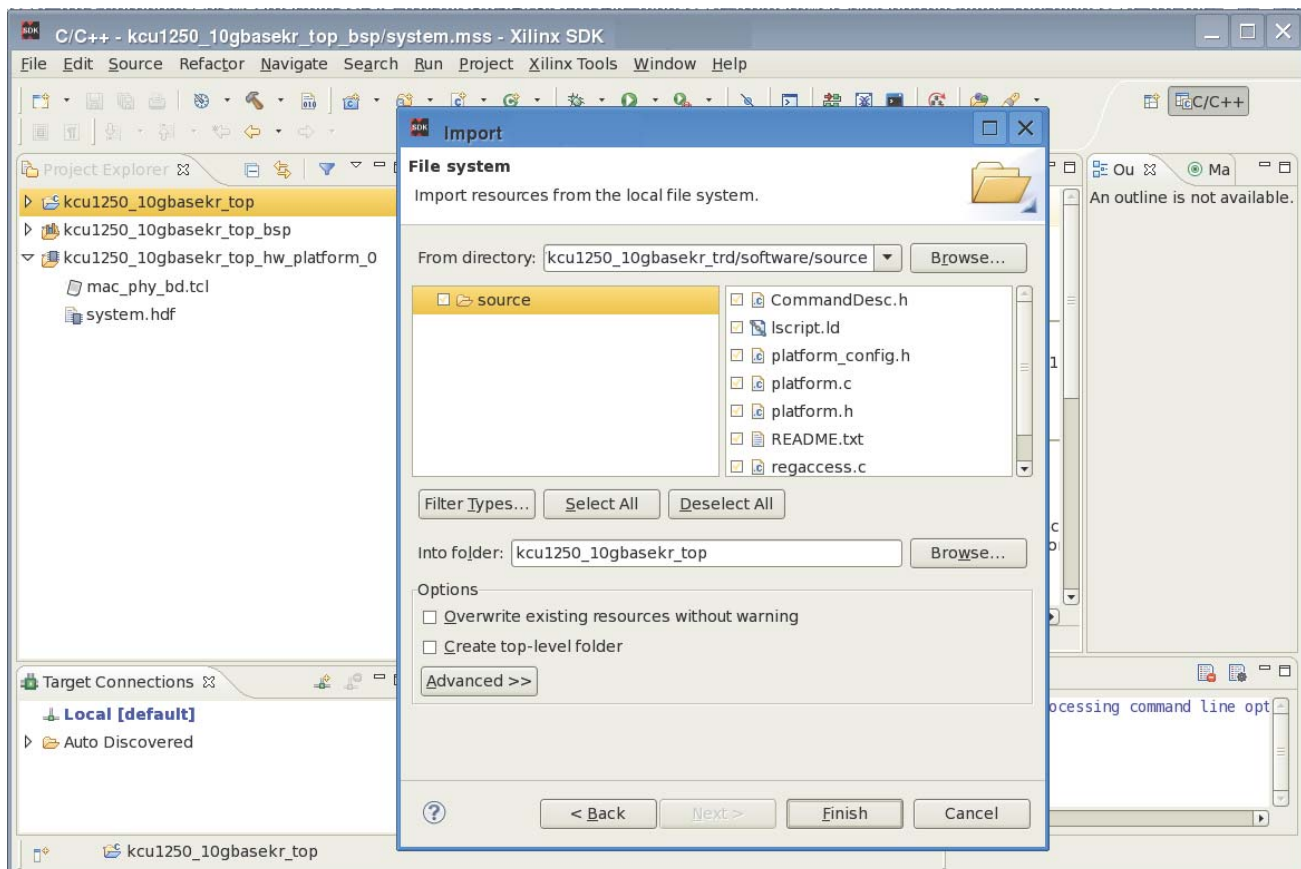

X18469-120716

Figure 4-8: Importing Software/Source Directory

- In the SDK window (Figure 4-10) select **File > New > Application Project** to build an application.

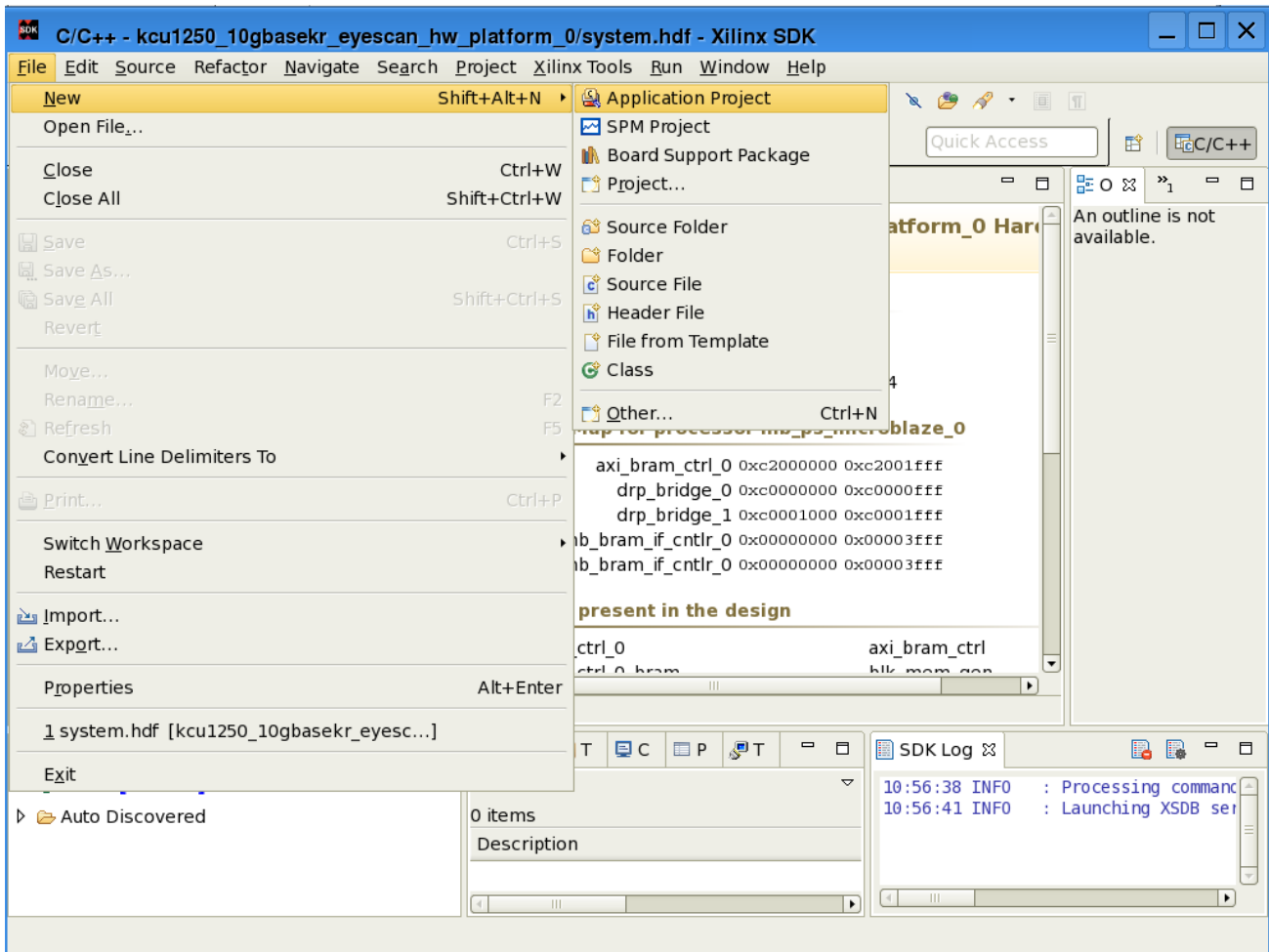

X18471-120716

Figure 4-10: Building an Application Project in the SDK

3. In the Application Project window (Figure 4-11) enter the project name as `kcu1250_10gbasekr_eyescan` and click **Next**.

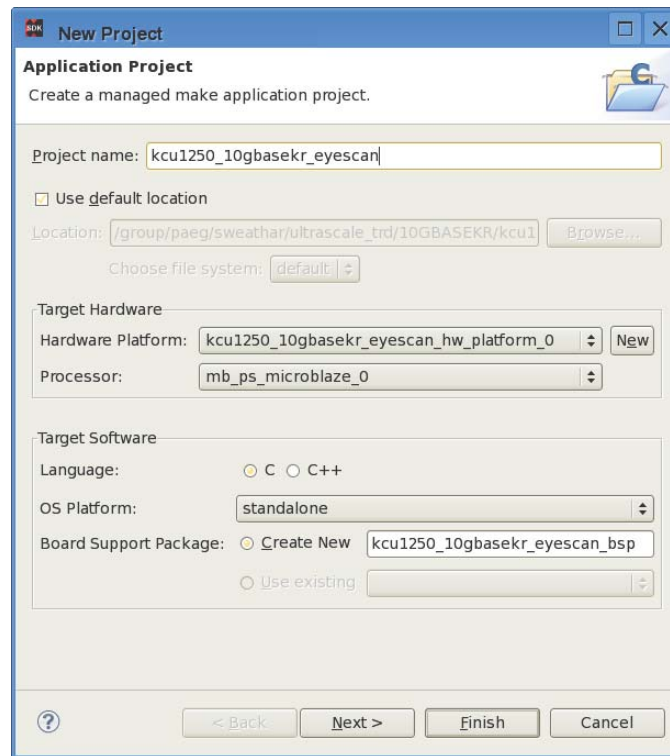

X18472-120716

Figure 4-11: Assigning a Project Name in the SDK

4. Select **Empty Application** and click **Finish** (Figure 4-12).

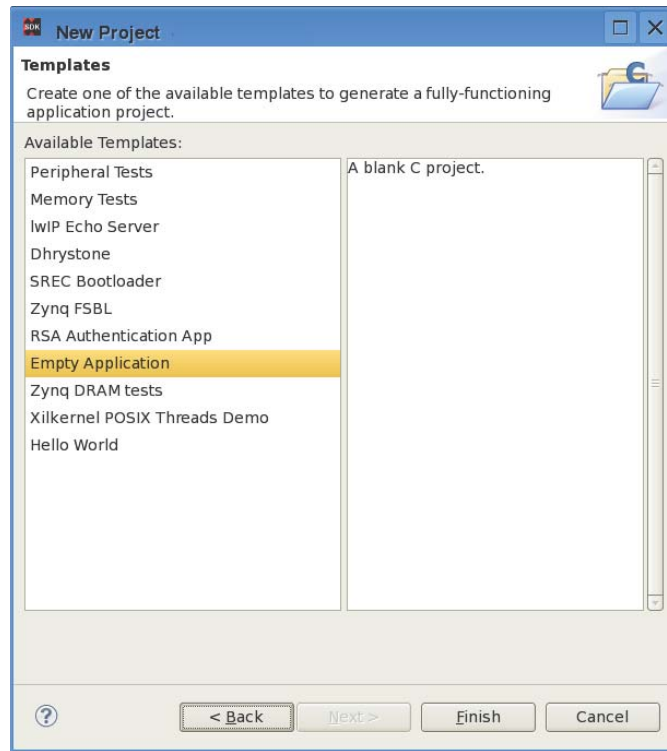

X18473-120716

Figure 4-12: Selecting Empty Application

- In the project explorer tab (Figure 4-13), right-click **kc1250_10gbasekr_eyescan**, select **Import**, and under the General tab select **File System**. Click **Next**.

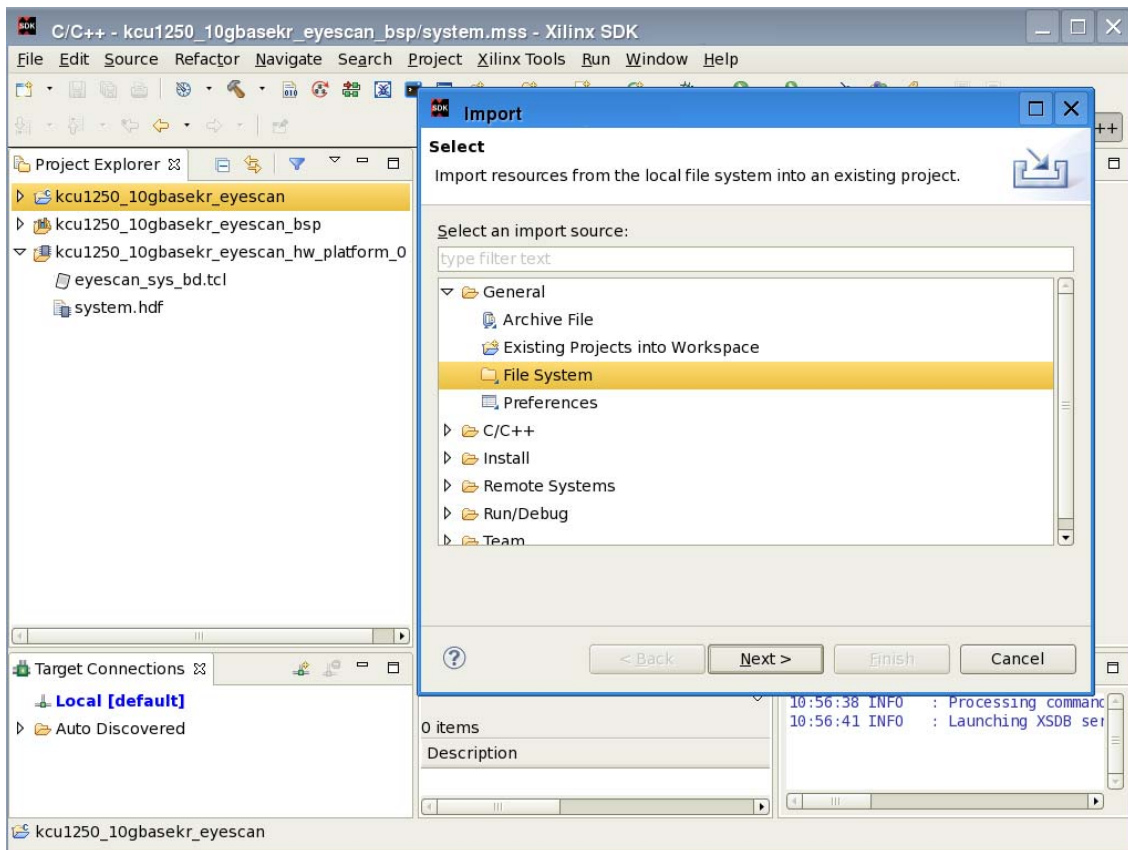

X18474-120716

Figure 4-13: Importing File System

6. Browse to source_eyescan folder:

`<working_dir>/kcu1250_10gbasekr_trd/software/source_eyescan`

Select the **source_eyescan** directory in the left pane and click **Finish** (Figure 4-14).

The application ELF file will be generated and available at:

`<working_dir>/kcu1250_10gbasekr_trd/hardware/vivado/runs/impl_run/10gbasekr_trd.sdk/eyescan/kcu1250_10gbasekr_eyescan/Debug/kcu1250_10gbasekr_eyescan.elf`

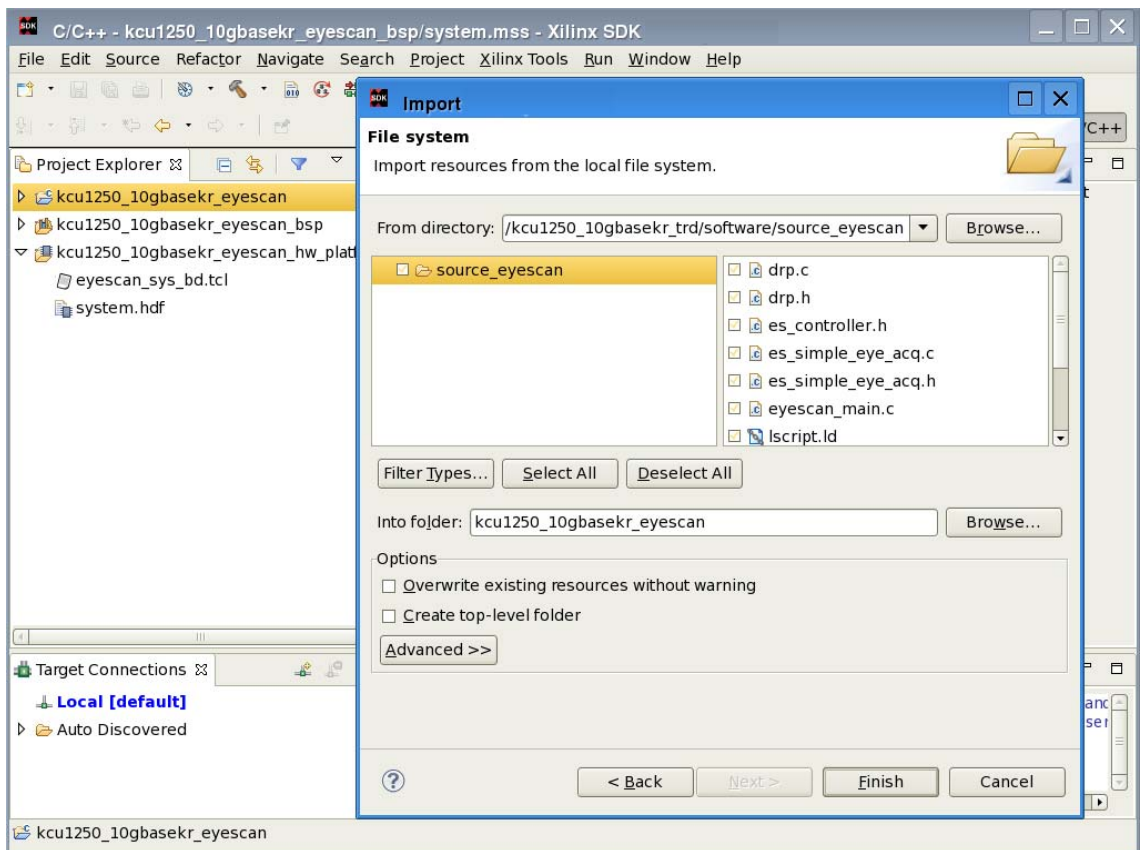

X18475-120716

Figure 4-14: Selecting the software/source Directory

Generate Bitstream For Download

1. Create a bitstream for download. In the Vivado Tcl Console (Figure 4-15) run the command:

```
source scripts/create_download_bit.tcl
```

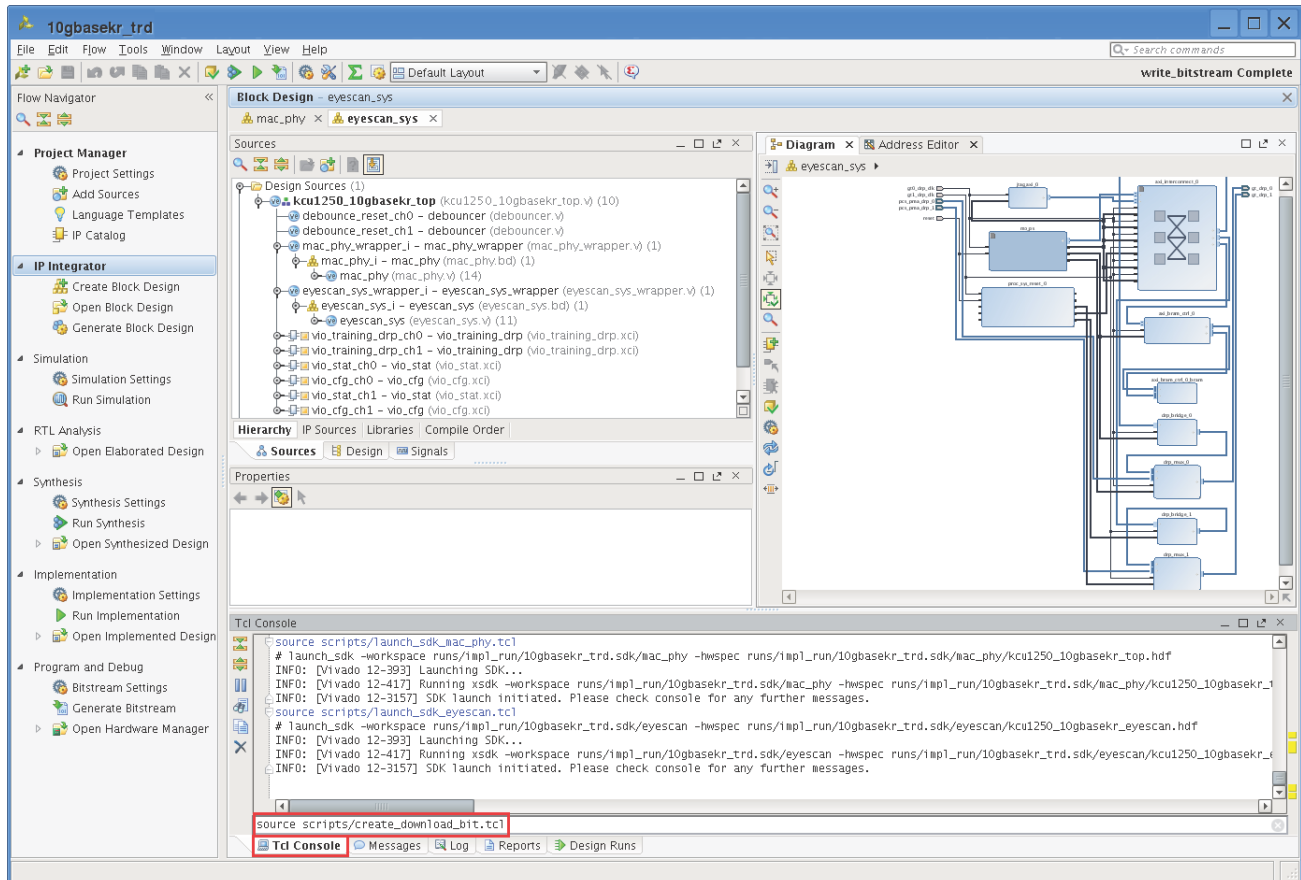

X18476-120716

Figure 4-15: Run Script to Create download.bit

The `create_download_bit.tcl` script runs the `update_mem` command and combines `kcu1250_10gbasekr_top.bit`, `kcu1250_10gbasekr_top.elf` and `kcu1250_10gbasekr_eyescan.elf` into single BIT file available at:

```
<working_dir>/kcu1250_10gbasekr_trd/hardware/vivado/runs/impl_run/10gbasekr_trd.runs/impl_1/kcu1250_10gbasekr_download.bit.
```

Simulating the Design

The 10GBASE-KR TRD can be simulated using the Vivado Design Suite simulator. The TRD can also be simulated using Modelsim/Quarta. Refer to *Vivado Design Suite User Guide: Logic Simulation* (UG900) [Ref 18], for information describing how to run simulations with different simulators.

The simulation environment sets up the Traffic Generator and Monitor blocks of the TRD. The Traffic Generator for channel 0 generates 10 packets which are transmitted to the 10-Gigabit Ethernet MAC IP core. The packets are looped back on the PHY and become receive packets on channel 1. Similarly, the Traffic Generator for channel 1 generates 10 packets which are transmitted to the 10-Gigabit Ethernet MAC IP core. The packets are looped back on the PHY and become receive packets on Channel 0. The test bench waits to receive the 10 packets on each channel without errors and then ends the simulation with a *Simulation Passed* message. Simulating the AXI UART Lite IP and MicroBlaze processor subsystem takes a lot of time. In order to speed up simulation the Traffic Generator and Monitor block is not configured using its AXI4-Lite interface connected to the MicroBlaze processor subsystem. The Traffic Generator and Monitor block provides a port *tg_config* to configure the block. This port is used only for simulation. Table 4-1 shows the bitmap for this port.

Table 4-1: Traffic Generator Configuration Port

Bit Position	Description
0	Enable loopback for external generator mode.
1	Enable generator for internal generator mode.
31:16	Ethernet frame data payload size. Allowed values (46 bytes to 1,500 bytes).

The test bench for the 10GBASE-KR TRD is available at:

`<working_dir>/kcu1250_10gbasekr_trd/hardware/sources/testbench/tb.v.`



IMPORTANT: Before running a simulation, the *kcu1250_10gbasekr_ref_design* project must be open and [step 1](#) under *Generate the Hardware Bitstream* must be executed.

To run a simulation in Modelsim/Questa:

1. In the Flow Navigator, under Simulation, click **Run Simulation > Run Behavioral Simulation** (Figure 4-16).

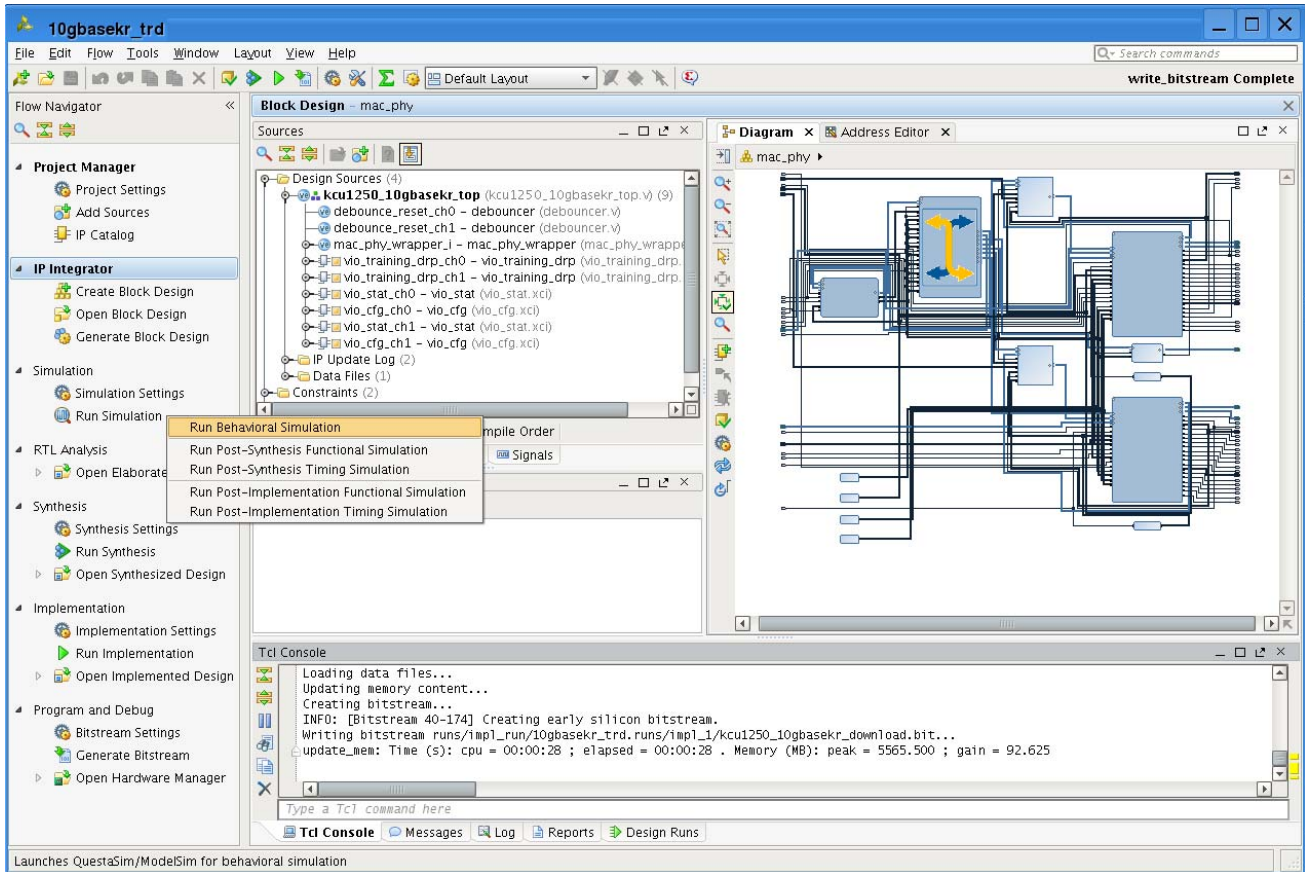

X18477-120716

Figure 4-16: Run ModelSim Simulation

To run a simulation using the Vivado Design Suite Simulator:

1. In the Flow Navigator, under Project Manager, click **Settings**.

- In the Project Settings window (Figure 4-17), select **Vivado Simulator** in the Target simulator field and click **Yes** when asked if it is OK to change your target simulator to Vivado Simulator. click **OK** in the Project Settings window.

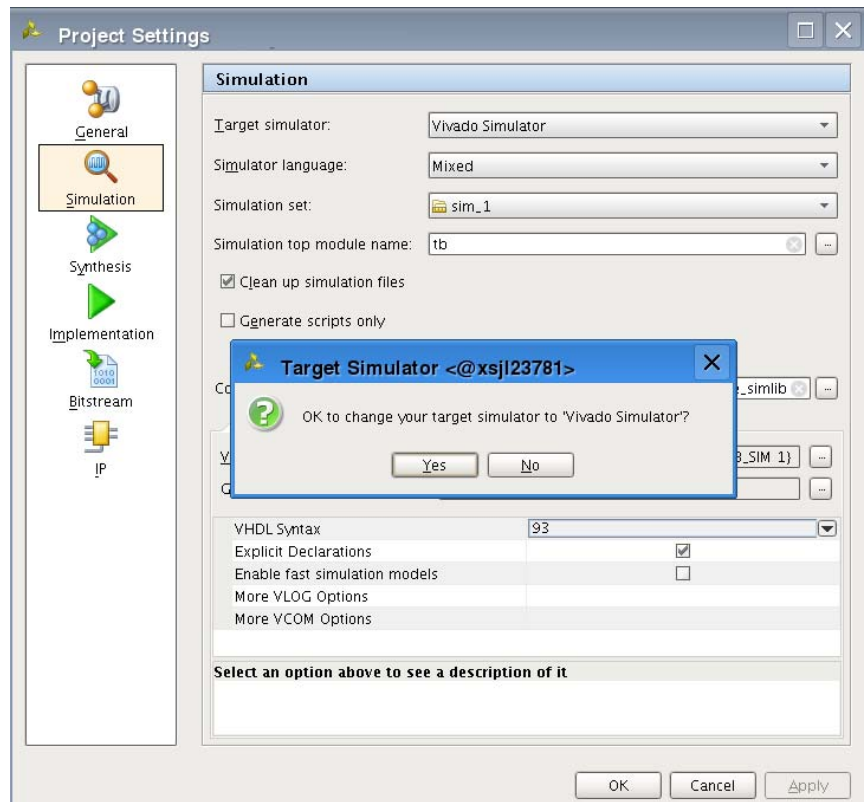

X18478-120716

Figure 4-17: Set Simulator to Vivado Simulator

- In the Flow Navigator, under Simulation, click **Run Simulation > Run Behavioral Simulation**.

Reference Design Details

This chapter describes the hardware design and software components.

Hardware

Figure 5-1 shows a block-level overview of the 10GBASE-KR TRD.

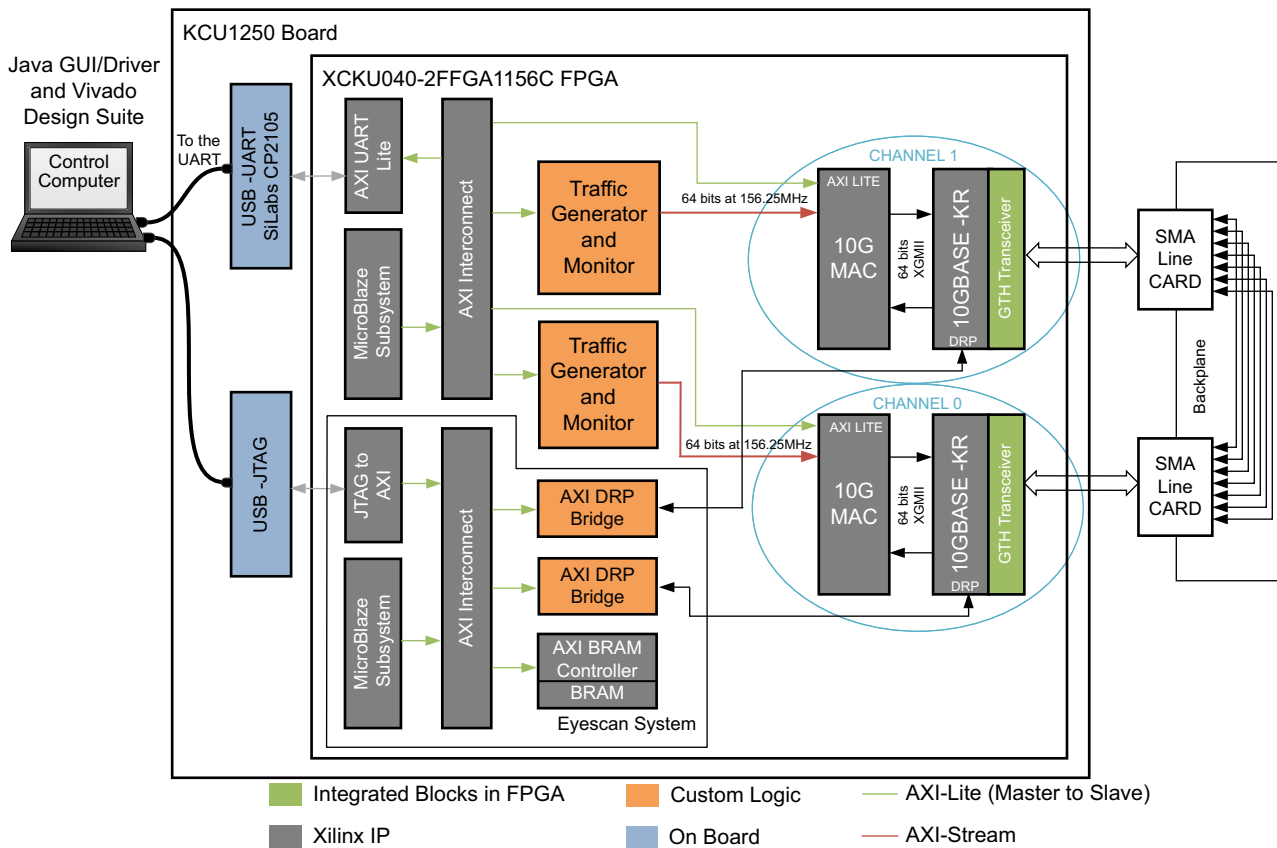

Figure 5-1: 10GBASE-KR TRD Block Diagram

The details of the hardware architecture are provided in three sections:

- **Data Plane Components:** Describes the 10-Gigabit Ethernet PCS/PMA IP core (10GBASE-KR), 10-Gigabit Ethernet MAC IP core (10G MAC) and the Traffic Generator and Monitor.
- **Control Plane Components:** Describes the MicroBlaze™ processor subsystem and the peripherals connected to it.
- **Eye Scan System Components** Describes the MicroBlaze processor subsystem and JTAG to AXI Master IP core that communicate with the DRP port of the transceivers to collect data samples and create an eye diagram.
- **Clocking and Reset:** Describes how clocks and resets are distributed to the different components in the 10GBASE-KR TRD.

Data Plane Components

The 10-Gigabit Ethernet PCS/PMA IP (10GBASE-KR) and 10-Gigabit Ethernet MAC IP (10G MAC) cores constitute a 10 Gb/s Ethernet channel. There are two channels in the 10GBASE-KR TRD; channel 0 and channel 1. The data source for each channel is a Traffic Generator implemented in the FPGA that drives the 10G Ethernet MAC.

10-Gigabit Ethernet PCS/PMA IP Core

The 10-Gigabit Ethernet PCS/PMA (10GBASE-KR) IP core provides an XGMII interface to connect to a 10-Gigabit Ethernet MAC IP core and implements a 10.3125 Gb/s serial single-channel PHY (GTH transceiver) brought out to TXN/TXP and RXN/RXP I/O pins that are connected to differential SMA connector pairs on the board. SMA cables connect these signals to the backplane.

The 10GBASE-KR IP core is configured to support auto negotiation (AN) and forward error correction (FEC). The MDIO interface is disabled and configuration and status vectors are used to manage the core.

A license can be obtained at the 10 Gigabit Ethernet PCS/PMA with FEC/Auto-Negotiation (10GBASE-KR) website [\[Ref 17\]](#). More information is available in the *10G Ethernet PCS/PMA LogiCORE IP Product Guide* (PG068) [\[Ref 19\]](#).

Relevant bits of the configuration and status vectors are brought out to Virtual Input/Output (VIO) IP cores to configure and monitor the IP. The training port of the 10-Gigabit Ethernet PCS/PMA is also connected to a VIO IP core to access the transceiver's DRP address map.

More VIO IP core information is available at the Virtual Input/Output (VIO) website [\[Ref 20\]](#) and in the *Virtual Input/Output LogiCORE IP Product Guide* (PG159) [\[Ref 21\]](#). Details about the DRP address map is available in *UltraScale Architecture GTH Transceivers User Guide* (UG576) [\[Ref 15\]](#).

10-Gigabit Ethernet MAC IP Core

The 10-Gigabit Ethernet MAC (10G MAC) IP core is a single-speed, full-duplex, 10-Gb/s Ethernet Media Access Controller. This 10G MAC connects to the PHY layer through the XGMII interface. The internal Traffic Generator drives data on the AXI4-Stream ports of this IP.

A license can be obtained at the 10 Gigabit Ethernet Media Access Controller (10GEMAC) website [Ref 16]. More information is available the *10G Ethernet MAC LogiCORE IP Product Guide* (PG072) [Ref 22].

Traffic Generator and Monitor

Figure 5-2 shows the Traffic Generator and Monitor. The traffic generator block generates Ethernet Traffic. The performance monitor block monitors the AXI4-Stream ports of the 10-Gigabit Ethernet MAC IP core and reports throughput.

The User Control and Status Register block passes information to and from the Ethernet Controller application using the MicroBlaze processor subsystem.

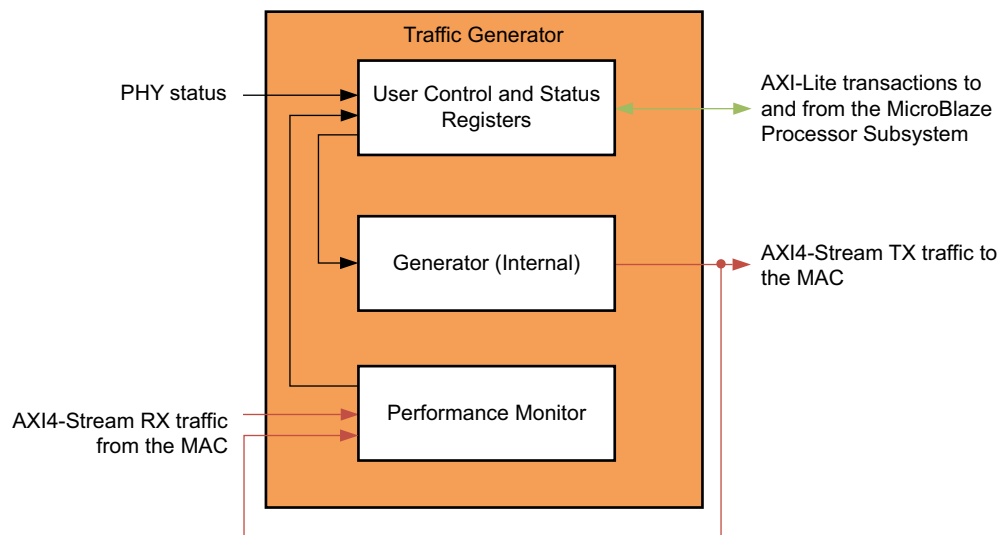

X18480-120716

Figure 5-2: Traffic Generator and Monitor

Internal Traffic Generator, Generator Module

The internal Traffic Generator module generates Ethernet packets based on user inputs provided from the Ethernet Controller application running on the control computer. Data payload size can be from 46 bytes to 1,500 bytes. Table 5-1 shows the packet format generated by the internal Traffic Generator module.

Table 5-1: Packet Format of Generated Packets

Byte 7	Byte 6	Byte 5	Byte 4	Byte 3	Byte 2	Byte 1	Byte 0
Source Address			Destination Address				
Sequence Number		Length		Source Address			
.....				Sequence Number		Sequence Number	
Sequence Number						

The source and destination MAC addresses are parameters into this block. The length field is the data payload value. The actual length of a packet generated by this block is:

- 14 bytes of header (Destination Address + Source Address + Length/Type Field) + Data payload

The sequence number field indicates packet count and increments by one every packet.

The generated packets are transmitted on AXI4-Stream interface to the 10-Gigabit Ethernet MAC IP core. Table 5-2 shows the parameters and ports on the generator module.

Table 5-2: Generator Module Parameters and Ports

Port/Parameter Name	Type	Description
XIL_MAC_ID_THIS	Parameter	Source MAC Address For channel 0 = 48'h111100000000 For channel 1 = 48'h222200000000
XIL_MAC_ID_OTHER	Parameter	Destination MAC Address For channel 0 = 48'h222200000000 For channel 1 = 48'h111100000000
Clock and Reset Ports		
reset	Input	Synchronous reset.
tx_axis_clk	Input	156.25 MHz clock transmit ports on the AXI4-Stream interface.
Transmit Ports on the AXI4-Stream Interface		
tx_axis_tdata[63:0]	Output	Data to be transmitted to the 10-Gigabit Ethernet MAC IP core.
tx_axis_tkeep[7:0]		The transmit keep signal is used to determine which data bytes are valid on tx_axis_tdata during a given beat (this signal is valid only if tx_axis_tvalid and tx_axis_tready are both asserted). Bit 0 corresponds to the least significant byte on tx_axis_tdata and bit 7 corresponds to the most significant byte. When tx_axis_tlast is not asserted, the only valid value is 0xFF. When tx_axis_tlast is asserted, valid values are 0x1, 0x3, 0x7, 0xf, 0x1f, 0x3f, 0x7f and 0xff.
tx_axis_tlast	Output	End of frame indicator on transmit packets. Valid only along with assertion of tx_axis_tvalid.
tx_axis_tvalid	Output	Source ready to provide transmit data. Indicates that the generator is presenting valid data on tx_axis_tdata.

Table 5-2: Generator Module Parameters and Ports (Cont'd)

Port/Parameter Name	Type	Description
tx_axis_tuser	Output	If asserted indicates an underrun frame. This is tied to 1'b0.
tx_axis_tready	Input	Destination ready for transmit. Indicates that the 10-Gigabit Ethernet MAC IP core is ready to accept data on tx_axis_tdata. The simultaneous assertion of tx_axis_tvalid and tx_axis_tready marks the successful transfer of one data beat on tx_axis_tdata.
Control Ports		
enable_gen	Input	Enable internal generator.
data_payload	Input	Size of the payload (46 bytes to 1,500 Bytes).

The data flow with internal generator mode enabled on the Traffic Generator for channel 0 is:

Generator module CH0 → CH0 TX AXI4-Stream interface of the 10-Gigabit Ethernet MAC IP → CH0 TX XGMII interface of the 10-Gigabit Ethernet PCS/PMA IP → CH0 TXN/TXP serial lines → loopback to CH1 RXN/RXP serial lines → CH1 RX XGMII interface of the 10-Gigabit Ethernet PCS/PMA → CH1 RX AXI4-Stream interface of the 10-Gigabit Ethernet MAC IP core

The data flow with internal generator mode enabled on Traffic Generator for channel 1 is:

Generator module CH1 → CH1 TX AXI4-Stream interface of the 10-Gigabit Ethernet MAC IP → CH1 TX XGMII interface of the 10-Gigabit Ethernet PCS/PMA IP → CH1 TXN/TXP serial lines → loopback to CH0 RXN/RXP serial lines → CH0 RX XGMII interface of the 10-Gigabit Ethernet PCS/PMA IP → CH0 RX AXI4-Stream interface of the 10-Gigabit Ethernet MAC IP core

Ethernet Performance Monitor

The Ethernet performance monitor block snoops for valid transactions on the AXI4-Stream interface ports of the 10-Gigabit Ethernet MAC IP core and keeps track of bandwidth utilization. A timer within this block counts the clocks until one second has elapsed, during which time counters have collected data about link performance.

Four counters collect information on the transactions on the AXI4-Stream interface:

- TX Payload Byte Count. This counter counts bytes transferred when tx_tvalid and tx_tready signals are asserted between the Traffic Generator block and the 10G MAC. At the end of the packet (tx_tlast) 14 bytes of header are subtracted from the count to get payload count.
- TX Packet Count. This counter counts the number of transmitted packets. The counter increments when tx_tvalid and tx_tready and tx_tlast signal are asserted.
- RX Payload Byte Count. This counter counts bytes transferred when rx_tvalid and rx_tready signals are asserted between the Traffic Generator block and the 10G MAC. At

the end of the packet (rx_tlast) 14 bytes of header are subtracted from the count to get payload count.

- RX Packet Count. This counter counts the number of received packets. The counter increments when rx_tvalid and rx_tready and rx_tlast signal are asserted.

The counts are truncated to a four-byte resolution, and the last two bits of the register indicate the sampling period. The last two bits transition every second from 00 to 01 to 10 to 11. The software polls the performance registers every second. If the sampling bits are the same as the previous read, then the software needs to discard the second read and try again. When the one-second timer expires, the new byte counts are loaded into the registers, overwriting the previous values. Table 5-3 shows the parameters and ports on this module.

Table 5-3: Ethernet Performance Monitor Parameters and Ports

Port/Parameter Name	Type	Description
ONE_SEC_CLOCK_COUNT	Parameter	Defines the number of 156.25 MHz clock cycles equivalent to 1 sec. Default value is 32'h9502F90.
Clock and Reset Ports		
reset	Input	Synchronous reset.
clk	Input	156.25 MHz clock.
Transmit Ports on the AXI4-Stream Interface		
tx_axis_tdata[63:0]	Input	Data to be transmitted to the 10-Gigabit Ethernet MAC IP core.
tx_axis_tkeep[7:0]		The transmit keep signal is used to determine which data bytes are valid on tx_axis_tdata during a given beat (this signal is valid only if tx_axis_tvalid and tx_axis_tready are both asserted). Bit 0 corresponds to the least significant byte on tx_axis_tdata and bit 7 corresponds to the most significant byte. When tx_axis_tlast is not asserted, the only valid value is 0xFF. When tx_axis_tlast is asserted, valid values are 0x01, 0x03, 0x07, 0x0F, 0x1F, 0x3F, 0x7F, and 0xFF.
tx_axis_tlast	Input	End of frame indicator on transmit packets. Valid only along with assertion of tx_axis_tvalid.
tx_axis_tvalid	Input	Source ready to provide transmit data. Indicates that the generator is presenting valid data on tx_axis_tdata.
tx_axis_tuser	Input	If asserted indicates an underrun frame. This is tied to 1'b0.
tx_axis_tready	Input	Destination ready for transmit. Indicates that the 10-Gigabit Ethernet MAC IP core is ready to accept data on tx_axis_tdata. The simultaneous assertion of tx_axis_tvalid and tx_axis_tready marks the successful transfer of one data beat on tx_axis_tdata.
Receive Ports on the AXI4-Stream Interface		
rx_axis_tdata[63:0]	Input	Data received by the 10-Gigabit Ethernet MAC IP core.

Table 5-3: Ethernet Performance Monitor Parameters and Ports (Cont'd)

Port/Parameter Name	Type	Description
rx_axis_tkeep[7:0]		The receive keep signal is used to determine which data bytes are valid on rx_axis_tdata during a given beat (this signal is valid only if tx_axis_tvalid and tx_axis_tready are both asserted).
rx_axis_tlast	Input	End of frame indicator on received packets. Valid only along with assertion of rx_axis_tvalid.
rx_axis_tvalid	Input	Source ready to provide data. Indicates that the MAC is presenting valid data on rx_axis_tdata.
rx_axis_tuser	Input	If asserted indicates a good packet is received.
rx_axis_tready	Output	Destination ready for receive. Indicates that the loopback is ready to accept data on rx_axis_tdata. The simultaneous assertion of rx_axis_tvalid and rx_axis_tready marks the successful transfer of one data beat on rx_axis_tdata. The 10-Gigabit Ethernet MAC IP core doesn't look at this signal and sends received data whenever available.
Performance Statistics Ports		
tx_byte_count	Output	Number of bytes transmitted in one second.
tx_pkt_count	Output	Number of packets transmitted in one second.
rx_byte_count	Output	Number of bytes received in one second.
rx_pkt_count	Output	Number of packets received in one second.

User Control and Status Registers

The user selections made in the Ethernet controller application are passed to the Traffic Generator and Monitor using this block. An AXI4-Lite interface is required for the MicroBlaze processor subsystem to execute reads (status) and writes (control) to this block. The AXI4-Lite IP Interface (IPIF) is instantiated in the design to read and write to a register map file (see the [AXI4-Lite IP Interface \(IPIF\)](#) website [Ref 23]).

Providing an AXI4-Lite slave interface provides the flexibility of using this module in other designs. To reuse this block, the control and status signals into the register map must be changed. [Appendix C, User-Space Registers](#) describes the registers implemented in the Traffic Generator and Monitor block. [Figure 5-3](#) shows the user register interface.

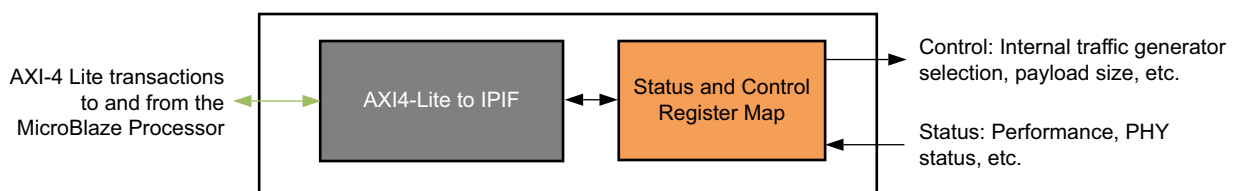

X18481-120716

Figure 5-3: User Register Interface

Control Plane Components

The Ethernet Controller application running on the control computer sends control information and receives status to and from different components of the 10GBASE-KR TRD using the MicroBlaze processor subsystem.

MicroBlaze Processor Subsystem and AXI Interconnect

The IP cores required to support the MicroBlaze processor and create a subsystem are:

- MicroBlaze local memory
- Processor system reset
- MicroBlaze debug module
- AXI Interrupt controller

In Vivado IPI, adding the MicroBlaze IP core and running the connection automation creates the MicroBlaze processor system shown in [Figure 5-4](#).

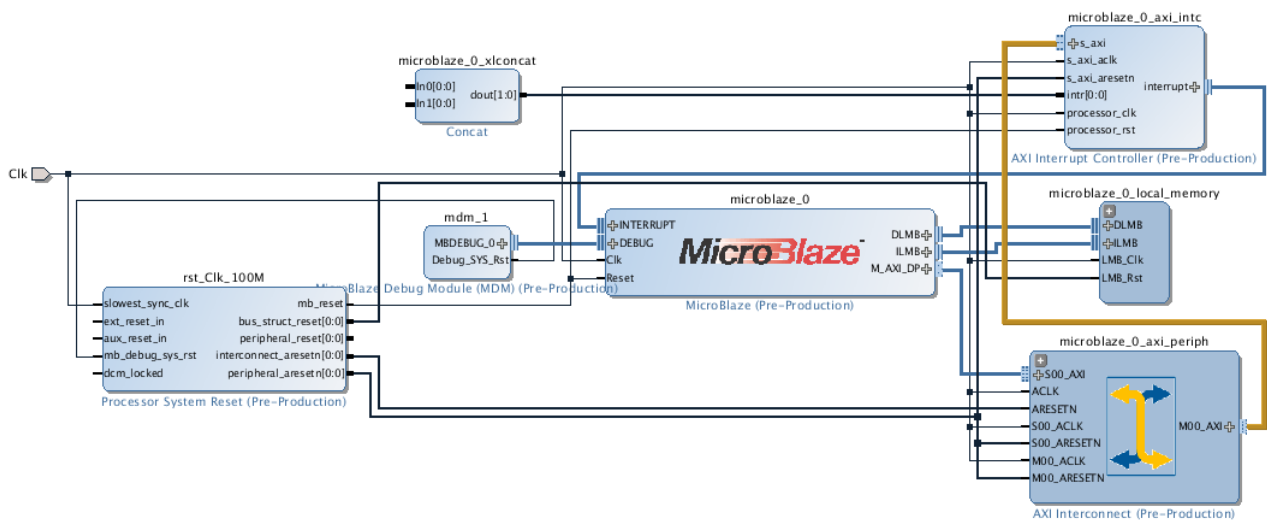

X18482-120716

Figure 5-4: IPI-Generated MicroBlaze Processor System

The AXI interconnect IP allows the MicroBlaze processor subsystem to communicate with the AXI Interrupt controller IP using the AXI4 memory mapped interface.

The 10GBASE-KR TRD AXI interconnect IP is reconfigured to have six master ports instead of one. The six master ports connect to six AXI slaves:

- AXI interrupt controller

- AXI UART Lite which communicates with the Ethernet Controller application running on the control computer
- Channel 0 – 10-Gigabit Ethernet MAC IP core
- The Traffic Generator and Monitor connected to channel 0
- Channel 1 – 10-Gigabit Ethernet MAC IP core
- The Traffic Generator and Monitor connected to channel 1

The AXI interconnect enables communication between the MicroBlaze processor subsystem (Master) and six peripherals (Slaves).

The address range assigned to each peripheral is shown in Figure 5-5. The application driver running on the MicroBlaze processor subsystem will use these addresses to map read/write transactions from the Ethernet Controller application to the AXI UART Lite to the MicroBlaze processor subsystem to other peripherals and back.

Cell	Interface Pin	Base Name	Offset Address	Range	High Address
microblaze_sub_system/microblaze_0					
Data (32 address bits : 4G)					
axi_uartlite_0	S_AXI	Reg	0x40600000	64K	0x4060FFFF
microblaze_sub_system/microblaze_0_local_memory/dlmb_bram_if_cntlr	SLMB	Mem	0x00000000	128K	0x0001FFFF
eth_axi_stream_gen_mon_0	s_axi	reg0	0x4AA00000	64K	0x4AA0FFFF
eth_axi_stream_gen_mon_1	s_axi	reg0	0x4AA10000	64K	0x4AA1FFFF
microblaze_sub_system/mdm_1	S_AXI	Reg	0x7E200000	64K	0x7E20FFFF
microblaze_sub_system/microblaze_0_axi_intc	s_axi	Reg	0x41200000	64K	0x4120FFFF
mac_phy_ch0/ten_gig_eth_mac_ch0	s_axi	Reg	0x74C00000	64K	0x74C0FFFF
mac_phy_ch1/ten_gig_eth_mac_ch1	s_axi	Reg	0x74C10000	64K	0x74C1FFFF
Instruction (32 address bits : 4G)					
microblaze_sub_system/microblaze_0_local_memory/ilmb_bram_if_cntlr	SLMB	Mem	0x00000000	128K	0x0001FFFF

X18483-120716

Figure 5-5: Peripheral Address Map

For more details on the MicroBlaze processor core, see the MicroBlaze Soft Processor Core website [Ref 24].

For more details on AXI Interconnect, see the AXI Interconnect website [Ref 25].

AXI UART Lite

The AXI UART Lite IP core provides the controller interface for asynchronous serial data transfer. The Ethernet Controller application running on the control computer communicates with this serial interface.

The AXI UART Lite IP core also connects to the MicroBlaze processor subsystem through the AXI interface and passes information to and from the Ethernet Controller application to the different components of the design.

For more details on AXI UART Lite, see *AXI UART Lite LogiCORE IP Product Guide* (PG142) [Ref 26] and the AXI UART Lite website [Ref 27].

Eye Scan System Components

The eye scan system in this reference design is based on application note XAPP1198. Refer to *In-System Eye Scan of a PCI Express Link with Vivado IP Integrator and AXI4 Application Note* (XAPP1198) [Ref 14] for more information.

AXI DRP Bridge

The AXI DRP bridge receives AXI requests from an AXI master such as the MicroBlaze processor subsystem. It converts AXI transactions to DRP registers accesses on the transceiver and routes the result back to the AXI Master. One bridge is required for every transceiver that performs an eye scan. This reference design has two instances of the AXI DRP bridge to get eye scan plots on 10-Gigabit Ethernet Channel 0 and Channel 1.

There is also an AXI DRP MUX in the reference design. This allows multiplexing of DRP accesses between the AXI DRP Bridge and the 10-Gigabit Ethernet PCS/PMA IP Core.

AXI Block RAM Controller

An AXI Slave IP core that allows access to local block RAM by AXI Master devices such as MicroBlaze processor subsystem and JTAG to AXI Master IP core. The block RAM stores the data read from the DRP port of the transceiver.

For more details on the AXI Block RAM Controller IP, see the AXI BRAM Controller website [Ref 28].

JTAG to AXI Master

The JTAG to AXI Master IP core is a customizable core that can generate AXI transactions and drive AXI signals internal to FPGA. The Vivado logic analyzer Tcl console running on the control computer interacts with this core through the USB-to-JTAG port on the KCU1250 board. (Refer to *Vivado Design Suite User Guide: Programming and Debugging* (UG908) [Ref 29].) It retrieves data stored in AXI BRAM Controller and passes it to the control computer.

For more details on the JTAG to AXI Master IP core, see the JTAG to AXI Master website [Ref 30].

MicroBlaze Processor Subsystem

The MicroBlaze processor subsystem communicates to the transceiver DRP interface through the AXI to DRP Bridge logic. The software running on the MicroBlaze processor is derived from code described in *Eye Scan with MicroBlaze Processor MCS Application Note* (XAPP743) [Ref 31]. The software running on the processor implements the Eye Scan algorithm on the transceiver and stores the data in the AXI block RAM. When the block RAM is filled with Eye Scan data, the JTAG to AXI IP core reads the data out of the block RAM.

Then it stores the data on the control computer in a text file through the USB-JTAG connection (U80) on the KCU1250 board.

For more details on the MicroBlaze processor core, see the MicroBlaze Soft Processor Core website [Ref 24].

AXI Interconnect

The AXI interconnect allows multiple AXI masters (MicroBlaze processor subsystem and JTAG to AXI Master) to communicate with multiple AXI slaves (AXI DRP Bridge and AXI BRAM Controller). The address map for the AXI slaves is shown in Figure 5-6.

Cell	Slave Interface	Base Name	Offset Address	Range	High Address
jtag_axi_0					
Data (32 address bits : 4G)					
axi_bram_ctrl_0	S_AXI	Mem0	0xC2000000	8K	0xC2001FFF
drp_bridge_0	AXI	reg0	0xC0000000	4K	0xC0000FFF
drp_bridge_1	AXI	reg0	0xC0001000	4K	0xC0001FFF
mb_ps/microblaze_0					
Data (32 address bits : 4G)					
axi_bram_ctrl_0	S_AXI	Mem0	0xC2000000	8K	0xC2001FFF
drp_bridge_0	AXI	reg0	0xC0000000	4K	0xC0000FFF
drp_bridge_1	AXI	reg0	0xC0001000	4K	0xC0001FFF
mb_ps/lmb_bram_if_cntlr_0	SLMB	Mem	0x00000000	16K	0x00003FFF
Instruction (32 address bits : 4G)					
mb_ps/lmb_bram_if_cntlr_0	SLMB1	Mem	0x00000000	16K	0x00003FFF

X18484-120716

Figure 5-6: AXI Slaves Address Map in the Eye Scan System

For more details on the AXI Interconnect, see the AXI Interconnect website [Ref 25].

Clocking and Reset

The 10-Gigabit Ethernet PCS/PMA core requires a 156.25 MHz differential reference clock for the GTH transceivers. The shared logic (clocking and reset logic) within the channel 0 10-Gigabit Ethernet PCS/PMA IP core produces a single ended 156.25 MHz clock. This clock is used by the 10-Gigabit Ethernet MAC and Traffic generator on Channel 0. A similar clock circuit is implemented for Channel 1. The MicroBlaze processor subsystem is driven by the

channel 0 156.25 MHz clock. The single ended 156.25 MHz clocks from both channels are routed to the eye scan system. [Figure 5-7](#) shows the clock distribution.

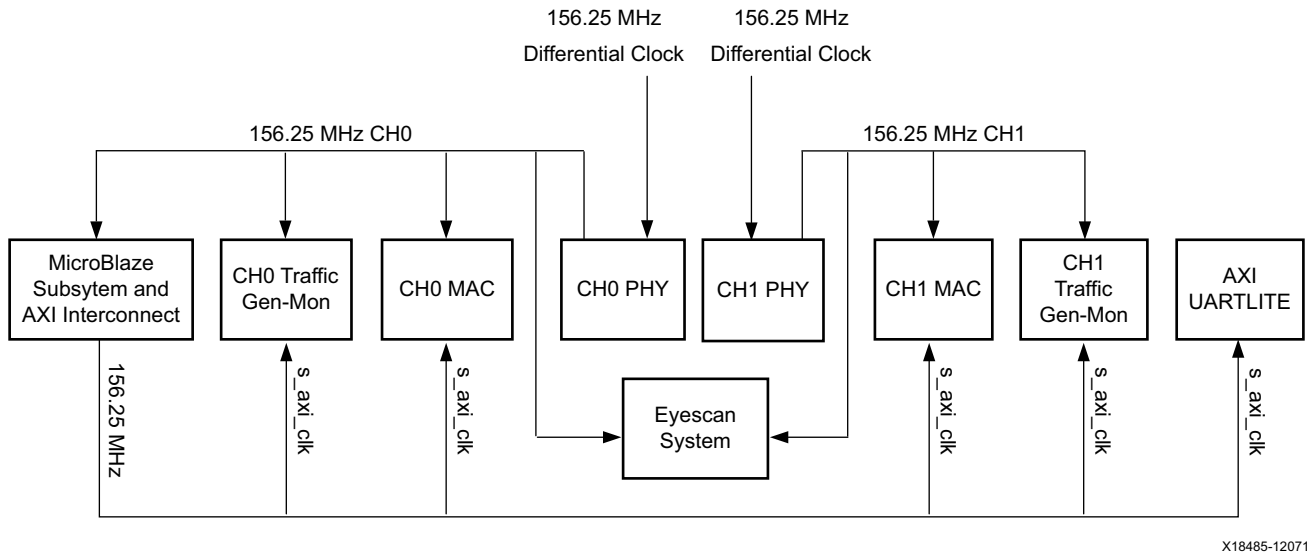

X18485-120716

Figure 5-7: Clock Distribution

An external reset (a debounced DIP switch) drives the channel 0 10-Gigabit Ethernet PCS/PMA IP core, the 10-Gigabit Ethernet MAC IP core and the Processor System Reset IP core in the processor system. This reset also drives the eye scan system.

Another external reset dip switch drives the Channel 1 10-Gigabit Ethernet PCS/PMA IP core, the 10-Gigabit Ethernet MAC IP core and the Traffic Generator and Monitor block.

The Processor System Reset Module IP core provides resets for the MicroBlaze processor subsystem components and resets to the AXI Interconnect and peripherals (AXI4-Lite interfaces on AXI UART Lite, Traffic Generator and Monitor, and 10-Gigabit Ethernet MAC IP). [Figure 5-8](#) shows the reset connections.

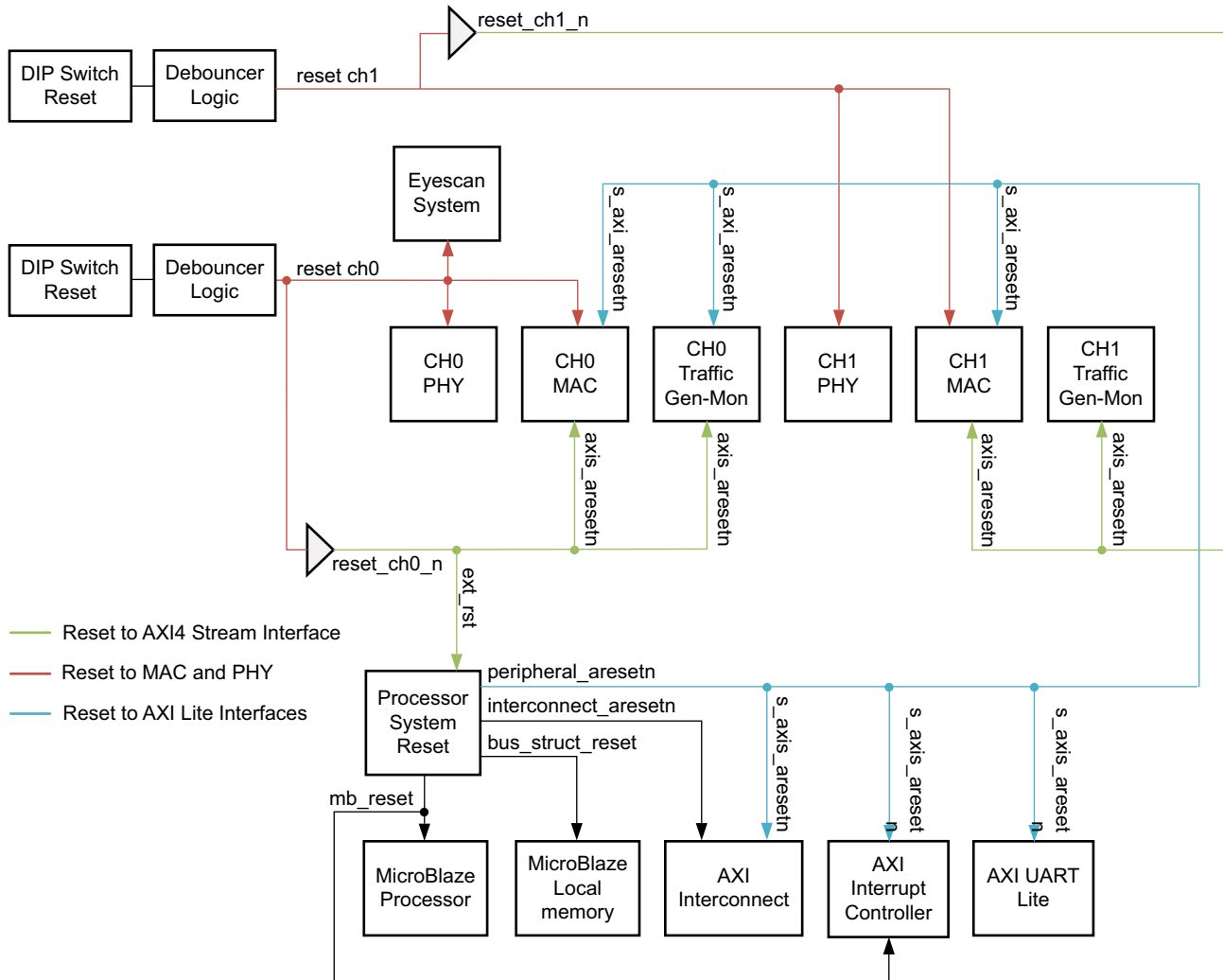

X18486-120716

Figure 5-8: Resets

Software

There are two major software components to monitor and control the Ethernet Reference Design System:

- [GUI/Client Application](#)
- [MicroBlaze Processor Server Application](#)

Figure 5-9 shows these components.

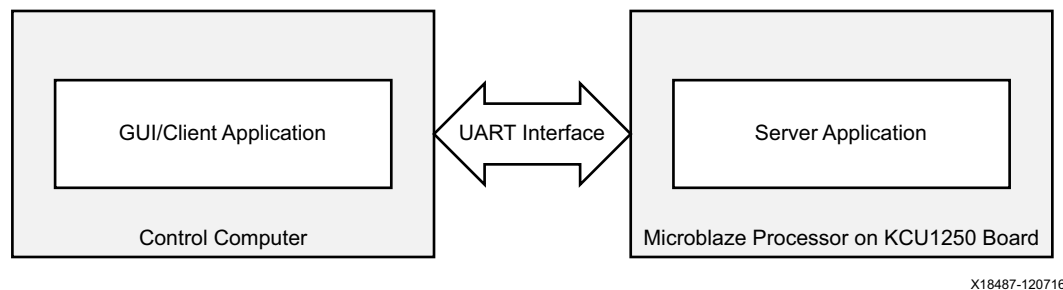

Figure 5-9: Software Components

GUI/Client Application

A Java-based GUI/Client application running on the control computer communicates with the MicroBlaze Processor Server Application through a UART interface to control test parameters, collect statistics, and display current status of the design.

The GUI displays the following information:

- Current mode of operation
- Payload size
- Throughput numbers and graphs when a test is executing
- 10-Gigabit Ethernet MAC IP statistics
- Power consumption and temperature for the FPGA
- Block diagram of the design

Figure 5-10 shows the GUI.

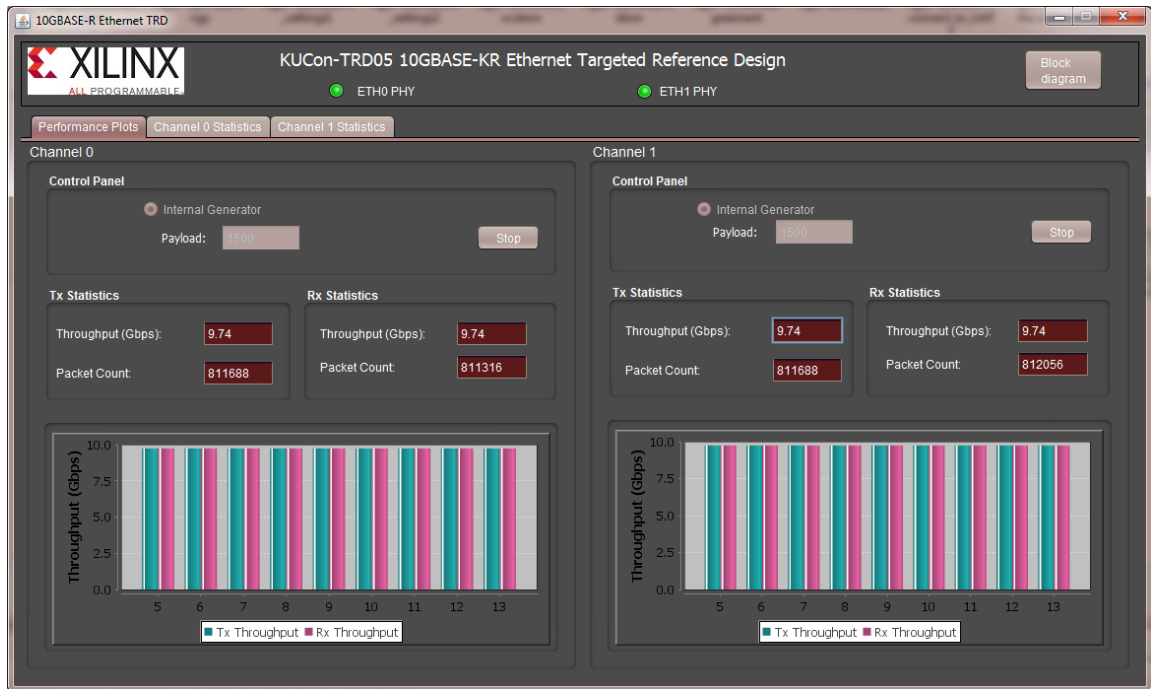

X18488-120716

Figure 5-10: GUI (Ethernet Controller Application)

The GUI provides control of:

- Test mode: Select use of the internal traffic generator to generate Ethernet traffic.
- Payload size: Specify the size of packets when running in internal generator mode.

The GUI interacts with the KCU1250 board through the UART COM port exposed by the Silicon Labs UART driver. All transmitted and received data adheres to a custom command model followed by the client and server.

Command Format

The command format used by the GUI for reading and writing 32-bit values to the registers in the design is described in this section.

Read Command

R <type of request> <output type> <Command number, denoted as a 4-character hexadecimal numeric string, AAAA>

- R denotes a Read command

- `type of request` indicates the type of request and it can either be:
 - `s` which specifies a single register read request, or
 - `b` which specifies a bulk read request

Use a single register read for debugging purposes or for reading registers which are not monitored by the GUI.

Use a bulk read command to make the GUI constantly poll all test parameters and statistics. This eliminates the need to send multiple commands for each individual value. A bulk read command reads the registers in a predefined order.

- `output type` indicates output type and it can be:
 - `h` specifies the value sent out by the server will be the actual data width i.e., 4 bytes
 - `a` specifies the value sent out by the server will be an 8-byte hexadecimal string
- `AAAA` denotes four character hexadecimal numeric string representation of the command number which will eventually be mapped to the actual register offset in the server application. Using different command numbers instead of the actual register values allows the GUI to remain constant in spite of changes in the hardware design or the application.

Example Read command:

`R s a 0001`: Read a single register corresponding to command number 0001 and the reported value from the server should be in 8-byte hexadecimal format.

Read command response:

1. The command number is read by the server and the appropriate register is identified, its value is read, and is stored in a 4-byte data value.
2. Based on the output type specified in the read command, the data is either directly transmitted to the client by the server, or it is converted to an 8-character string denoting an 8-character hexadecimal number and then sent out to the client on the control computer side.

Currently the application only supports output type of 8-character hexadecimal string.

An example Read command output response: `F000000F`.

Write Command

`W <Command Number denoted as a 4-character hexadecimal numeric string AAAA> < Data, represented as an 8-character hexadecimal numeric string DDDDDDDD>`

- `w` denotes a Write command

- AAAA denotes a 4-character hexadecimal string representation of the command number which will eventually be mapped to the actual register offset in the server application.
- DDDDDDDD denotes an 8-character hexadecimal string.

Example Write command:

- W 0001 007D0002: Write a value of 007D0002 to the register corresponding to command value 0001.

Write command is always targeted towards a single register.

The mapping of command numbers to the corresponding register values is the same for both Read and Write commands, i.e., if a write command with a certain command number is used to update a register value, the same command number can be used with a read command to retrieve the value.

MicroBlaze Processor Server Application

MicroBlaze Processor Server application running on the FPGA takes care of interpreting the read and write commands sent from the client application, and acts accordingly. The software layers are as shown in Figure 5-11.

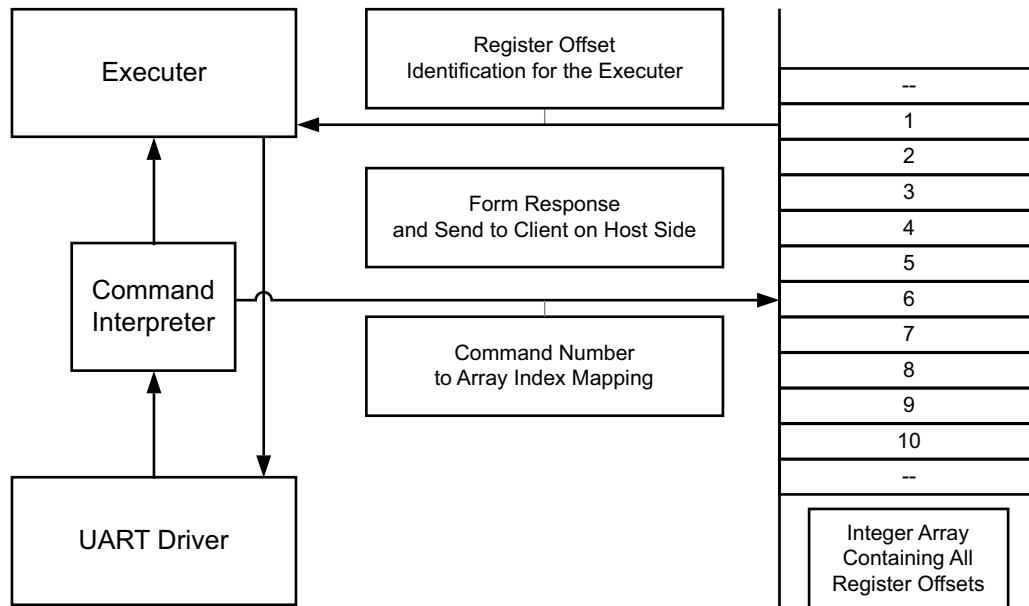

X18489-120716

Figure 5-11: Software Layers in the MicroBlaze Processor Server Application

When the hardware platform is exported to the Software Development Kit (SDK) as described in [Generate ELF File for the MicroBlaze Controller in mac_phy.bd](#):

- The drivers for standard peripherals (like UART, Interrupt controller, etc.) that are connected to the MicroBlaze processor are already available in the SDK.
- The base address of each peripheral assigned in the hardware platform as shown in [Figure 5-5](#) and is also accessible by the SDK.

The register offsets required by the server application to access relevant registers (TRD configuration registers, performance registers, MAC Statistics, etc.) are available in the *10G Ethernet MAC LogiCORE IP Product Guide* (PG072) [Ref 22] and the user space registers as described in [Appendix C, User-Space Registers](#).

The UART driver is responsible for transferring and receiving data from the UART interface. The server application uses the Application Programming Interface (API) provided by the UART driver and communicates with the client application running on the control computer. The main task of the server is to read/write values from/to the registers specified in the READ/WRITE commands issued by the GUI.

The various steps undertaken by the server in servicing requests from the client are:

1. Register offsets to access registers are put in an integer array during the initialization of MicroBlaze processor server application. The value placed in the integer array is:
 - Base address for the component + register offset
2. The order in which these register offset values are placed is made aware to the client application on the host side.
3. Each register is identified using a unique command number. This command number is same for both read and write commands.
4. When a client initiates a Read/Write command, the data is obtained by the server application through the UART driver.
5. The Command Interpreter part of the server application then interprets the data obtained from UART.
6. The Command Interpreter identifies the register offset value in the integer array, with respect to the command number associated with the request.
7. The Command Interpreter functionality is different for Single Read and Bulk Read commands.

8. For a single read request, command number shall give the index of the integer array where the referenced register offset is placed.

Example Single Read Command:

```
R s a 0001
```

Here the command number is translated to 1 and the offset value of the register being requested is placed in the zero index of the array.

9. For a bulk read request the command number represents a set of registers with a clearly defined start and end index positions in the array.

Example Bulk Read Command:

```
R b a 0001
```

Here the command number 1 represents a set of register offsets in the array, 2 to 17. The values placed at these array indexes are the Ethernet performance registers for Channel 0 and Channel 1.

10. The Executor part of the server application then initiates either AXI Read/Write request to the register offset values identified.
11. The Executor then sends an appropriate response to the client on control computer through the UART driver.



NOTE: *The bulk Read commands from GUI are serviced by the Server application by going through all the registers associated with the command in a predefined order and transferring the data with a ' ' (white space) as delimiter between each register's value. This mode greatly reduces the number of commands the GUI has to send to obtain the same amount of information.*

The source code for the MicroBlaze application is available under the `software/source` directory (see [Appendix A, Directory Structure](#)). The command mapping is defined in `CommandDesc.h`.



NOTE: *The software components for generating eye scans are described in [Eye Scan with MicroBlaze Processor MCS Application Note \(XAPP743\)](#) [Ref 31] and [In-System Eye Scan of a PCI Express Link with Vivado IP Integrator and AXI4 Application Note \(XAPP1198\)](#) [Ref 14] and are not covered in this document.*

Directory Structure

The directory structures for the 10GBASE-KR TRD is shown in [Figure A-1](#).

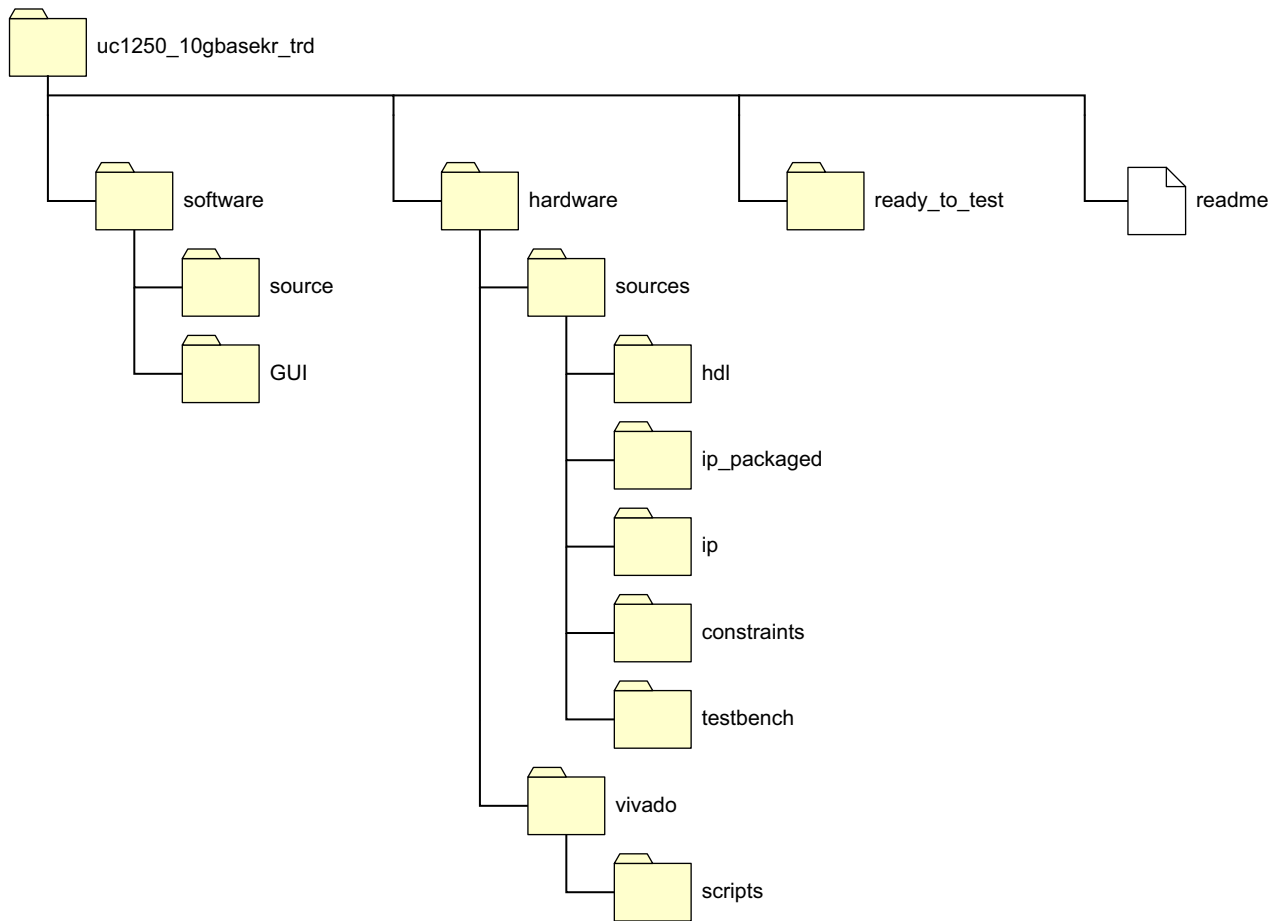

X18425-120716

Figure A-1: Targeted Reference Design Directory Structure

Directory Content Summary

The files and folders contained in the 10GBASE-KR TRD are described in [Table A-1](#). The top-level folder is `kcu1250_10gbasekr_trd`.

Table A-1: Directory Content

Folder	Description
software	Contains the software design deliverables.
source	Contains the source code files used for creating the ELF file application that runs on the MicroBlaze™ processor and communicates with the GUI.
GUI	Contains the EXE file used to install the Ethernet Controller GUI.
hardware	Contains all the required sources needed to generate a bitstream.
sources	Contains subfolders that contain HDL files, custom IP that is packaged, VIO IP files, constraint files, and test bench files.
hdl	Contains HDL files.
ip_packaged	Contains custom IP that is packaged.
ip	Contains VIO IP files.
constraints	Contains constraint files.
testbench	Contains test bench files.
vivado	Contains files to create a Vivado® Design Suite project and outputs of vivado runs.
scripts	Contains Tcl scripts to create a Vivado project.
runs	Created when the Tcl script file is sourced. The runs folder contains the output of simulation, synthesis and implementation processes.
ready_to_test	Contains the bit file to program the KCU1250 characterization board.
readme	A TXT file that describes the 10GBASE-KR TRD and includes revision history information.

Performance Estimates

The 10-Gigabit Ethernet MAC IP core operates at a clock rate of 156.25 MHz using a 64-bit data-path width ($64 \times 156.25 \times 10^6 = 10 \text{ Gb/s}$).

For the XGMII, the minimum required interframe gap is 12 bytes. Header overhead consists of a preamble (7 bytes) + Start of frame delimiter (1 byte) + MAC destination address (6 bytes) + MAC source address (6 bytes) + Length/Type field (2 bytes) + FCS (4 bytes). This gives a total overhead of 38 bytes per Ethernet packet.

[Table B-1](#) shows the effective throughput and percentage of maximum bandwidth used for four different payload sizes.

Table B-1: Effective Throughput as a Function of Payload

Ethernet Payload Size (Bytes)	Percentage of Bandwidth = Payload size/Packet size * 100	Effective Throughput (Gb/s)
64	$64/(38 + 64) = 62.7\%$	6.27
512	$512/(38 + 512) = 93.1\%$	9.31
1024	$1024/(38 + 1024) = 96.3\%$	9.63
1500	$1500/(38 + 1500) = 97.5\%$	9.75

User-Space Registers

User space registers are user-defined registers implemented in the Traffic Generator and Monitor block shown in [Figure 5-1](#). These registers can be accessed by the MicroBlaze™ processor subsystem via the AXI4-Lite interface.

[Table C-1](#) through [Table C-14](#) describe the custom registers implemented in the 10GBASE-KR TRD. All registers are 32 bits wide. Register bit positions are to be read from bit 31 to bit 0 from left to right. All bits that are undefined in this section are reserved and will return zero when read. Address holes will also return a value of zero when read.

Each peripheral connected to the MicroBlaze processor subsystem is assigned an offset address which is the base address for that peripheral. [Figure 5-5](#) shows the addresses assigned to the Traffic Generator and Monitor blocks (eth_axi_stream_gen_mon_0 and eth_axi_stream_gen_mon_1). The Traffic Generator and Monitor base addresses are:

- Traffic Generator and Monitor channel 0: 0x4AA0_0000
- Traffic Generator and Monitor channel 1: 0x4AA1_0000

Control and Status Registers

Traffic Generator—Monitor Channel 0

Table C-1: Design Version Register (0x4AA0_0000)

Bit Position	Mode	Default Value	Description
3:0	Read Only	4'h2	Ethernet reference design 2.
15:4		12'h141	Indicates the Vivado® Design Suite version used when developing this reference design. For example, Vivado Design Suite 2014.1 is indicated by 141.
31:16		16'h1250	Target Board: KCU1250 board.

Table C-2: Ethernet Performance Monitor, Transmit Payload Byte Count Register (0x4AA0_0004)

Bit Position	Mode	Default Value	Description
1:0	Read Only	00	Sample count. Increments once every second.
31:2		0	Transmit payload byte count. This field contains the interface utilization count for active beats (tx_axis_tready = 1 and tx_axis_tvalid = 1) on channel 0 10G Ethernet MAC AXI4-Stream interface for transmit.

Table C-3: Ethernet Performance Monitor, Transmit Packet Count Register (0x4AA0_0008)

Bit Position	Mode	Default Value	Description
1:0	Read Only	00	Sample count. Increments once every second.
31:2		0	Transmit packet count. This field contains the count for the event when there is an active beat on channel 0 10G Ethernet MAC AXI4-Stream interface and end of packet (tx_axis_tlast) is asserted for transmit.

Table C-4: Ethernet Performance Monitor, Received Payload Byte Count Register (0x4AA0_000C)

Bit Position	Mode	Default Value	Description
1:0	Read Only	00	Sample count. Increments once every second.
31:2		0	Receive payload byte count. This field contains the interface utilization count for active beats (rx_axis_tready = 1 and rx_axis_tvalid = 1) on channel 0 10G Ethernet MAC AXI4-Stream interface for receive.

Table C-5: Ethernet Performance Monitor, Received Packet Count Register (0x4AA0_0010)

Bit Position	Mode	Default Value	Description
1:0	Read Only	00	Sample count. Increments once every second.
31:2		0	Receive packet count. This field contains the count for the event when there is an active beat on channel 0 10G Ethernet MAC AXI4-Stream interface and end of packet (rx_axis_tlast) is asserted for receive.

Table C-6: Traffic Generator Configuration Register (0x4AA0_0014)

Bit Position	Mode	Default Value	Description
0	Read or Write	0	Reserved.
1		0	Enable generator if internal generator is selected.
31:16		d' 125	Ethernet frame data payload size. Allowed values (46 bytes to 1,500 bytes).

Table C-7: PHY status Register (0x4AA0_00x18)

Bit Position	Mode	Default Value	Description
0	Read Only	0	PHY is up.

Traffic Generator—Monitor Channel 1

Table C-8: Design Version Register (0x4AA1_0000)

Bit Position	Mode	Default Value	Description
4:0	Read Only	4'h2	Ethernet reference design 2.
14:5		12'h173	Software version: Indicates the Vivado® Design Suite version used when developing this reference design. For example, Vivado Design Suite 2017.3 is indicated by 173.
31:16		16'h1250	Target Board. KCU1250 board.

Table C-9: Ethernet Performance Monitor, Transmit Payload Byte Count Register (0x4AA1_0004)

Bit Position	Mode	Default Value	Description
1:0	Read Only	00	Sample count. Increments once every second.
31:2		0	Transmit payload byte count. This field contains the interface utilization count for active beats (tx_axis_tready = 1 and tx_axis_tvalid = 1) on channel 1 10G Ethernet MAC AXI4-Stream interface for transmit.

Table C-10: Ethernet Performance Monitor, Transmit Packet Count Register (0x4AA1_0008)

Bit Position	Mode	Default Value	Description
1:0	Read Only	00	Sample count. Increments once every second.
31:2		0	Transmit packet count. This field contains the count for the event when there is an active beat on channel 1 10G Ethernet MAC AXI4-Stream interface and end of packet (tx_axis_tlast) is asserted for transmit.

Table C-11: Ethernet Performance Monitor, Received Payload Byte Count Register (0x4AA1_000C)

Bit Position	Mode	Default Value	Description
1:0	Read Only	00	Sample count. Increments once every second.
31:2		0	Receive payload byte count. This field contains the interface utilization count for active beats (rx_axis_tready = 1 and rx_axis_tvalid = 1) on channel 1 - 10G Ethernet MAC AXI4-Stream interface for receive.

Table C-12: Ethernet Performance Monitor, Received Packet Count Register (0x4AA1_0010)

Bit Position	Mode	Default Value	Description
1:0	Read Only	00	Sample count. Increments once every second.
31:2		0	Receive packet count. This field contains the count for the event when there is an active beat on channel 1 10G Ethernet MAC AXI4-Stream interface and end of packet (rx_axis_tlast) is asserted for receive.

Table C-13: Traffic Generator Configuration Register (0x4AA1_0014)

Bit Position	Mode	Default Value	Description
0	Read or Write	0	Reserved.
1		0	Enable generator if internal generator is selected.
31:16		d'125	Ethernet frame. Data payload size allowed values = 46 bytes to 1,500 bytes.

Table C-14: status Register (0x4AA1_00x18)

Bit Position	Mode	Default Value	Description
0	Read Only	0	PHY is up.

Additional Resources and Legal Notices

Xilinx Resources

For support resources such as Answers, Documentation, Downloads, and Forums, see [Xilinx Support](#).

Solution Centers

See the [Xilinx Solution Centers](#) for support on devices, software tools, and intellectual property at all stages of the design cycle. Topics include design assistance, advisories, and troubleshooting tips.

Documentation Navigator and Design Hubs

Xilinx® Documentation Navigator provides access to Xilinx documents, videos, and support resources, which you can filter and search to find information. To open the Xilinx Documentation Navigator (DocNav):

- From the Vivado® IDE, select **Help > Documentation and Tutorials**.
- On Windows, select **Start > All Programs > Xilinx Design Tools > DocNav**.
- At the Linux command prompt, enter `docnav`.

Xilinx Design Hubs provide links to documentation organized by design tasks and other topics, which you can use to learn key concepts and address frequently asked questions. To access the Design Hubs:

- In the Xilinx Documentation Navigator, click the **Design Hubs View** tab.
- On the Xilinx website, see the [Design Hubs](#) page.

Note: For more information on Documentation Navigator, see the [Documentation Navigator](#) page on the Xilinx website.

References

The most up-to-date information for this design is available on these websites:

[KCU1250 Characterization Kit](#)

[KCU1250 Characterization Kit Documentation](#)

[KCU1250 Characterization Kit Master Answer Record \(AR 63058\)](#)

These documents and sites provide supplemental material:

1. [IEEE Std 802.3-2012](#)
IEEE Standard for Ethernet (includes specifications for 10GBASE-KR and 10GBASE-R)
2. [KCU1250 Characterization Kit](#) website
3. [Tyco Electronics](#) website
Z-Pack TINMAN Customer System Kit User's Guide (backplane)
4. [Samtec Bulls Eye cables](#) website
5. [Aeroflex/Inmet](#) website: SMA DC Blocks
6. [Silicon Labs](#) CP210x USB to UART Bridge VCP Drivers
7. [Tera Term Home Page](#): Tera Term Pro terminal emulator software
8. *Vivado Design Suite User Guide Release Notes, Installation, and Licensing* ([UG973](#))
9. *Silicon Labs CP210x USB-to-UART Installation Guide* ([UG1033](#))
10. *Tera Term Terminal Emulator Installation Guide* ([UG1036](#))
11. [Oracle](#) Java SE Runtime Environment 7
12. *KCU1250 Characterization Board Schematics* ([XTP398](#))
13. *HW-CLK-101-SCLK2 SuperClock-2 Module User Guide* ([UG770](#))
14. *In-System Eye Scan of a PCI Express Link with Vivado IP Integrator and AXI4 Application Note* ([XAPP1198](#))
15. *UltraScale Architecture GTH Transceivers User Guide* ([UG576](#))
16. [10 Gigabit Ethernet Media Access Controller \(10GEMAC\)](#) website
17. [10 Gigabit Ethernet PCS/PMA with FEC/Auto-Negotiation \(10GBASE-KR\)](#) website
18. *Vivado Design Suite User Guide: Logic Simulation* ([UG900](#))
19. *10G Ethernet PCS/PMA LogiCORE IP Product Guide* ([PG068](#))
20. [Virtual Input/Output \(VIO\)](#) website
21. *Virtual Input/Output LogiCORE IP Product Guide* ([PG159](#))

22. *10G Ethernet MAC LogiCORE IP Product Guide* ([PG072](#))
 23. [AXI4-Lite IP Interface \(IPIF\) website](#)
 24. [MicroBlaze Soft Processor Core website](#)
 25. [AXI Interconnect website](#)
 26. *AXI UART Lite LogiCORE IP Product Guide* ([PG142](#))
 27. [AXI UART Lite website](#)
 28. [AXI BRAM Controller website](#)
 29. *Vivado Design Suite User Guide: Programming and Debugging* ([UG908](#))
 30. [JTAG to AXI Master website](#)
 31. *Eye Scan with MicroBlaze Processor MCS Application Note* ([XAPP743](#))
 32. *UltraScale Architecture System Monitor User Guide* ([UG580](#))
 33. *AXI4-Lite IPIF LogiCORE IP Product Guide* ([PG155](#))
 34. *System Management Wizard LogiCORE IP Product Guide* ([PG185](#))
-

Training Resources

35. [Vivado Design Suite Hands-on Introductory Workshop](#)
 36. [Vivado Design Suite Tool Flow](#)
-

Please Read: Important Legal Notices

The information disclosed to you hereunder (the "Materials") is provided solely for the selection and use of Xilinx products. To the maximum extent permitted by applicable law: (1) Materials are made available "AS IS" and with all faults, Xilinx hereby DISCLAIMS ALL WARRANTIES AND CONDITIONS, EXPRESS, IMPLIED, OR STATUTORY, INCLUDING BUT NOT LIMITED TO WARRANTIES OF MERCHANTABILITY, NON-INFRINGEMENT, OR FITNESS FOR ANY PARTICULAR PURPOSE; and (2) Xilinx shall not be liable (whether in contract or tort, including negligence, or under any other theory of liability) for any loss or damage of any kind or nature related to, arising under, or in connection with, the Materials (including your use of the Materials), including for any direct, indirect, special, incidental, or consequential loss or damage (including loss of data, profits, goodwill, or any type of loss or damage suffered as a result of any action brought by a third party) even if such damage or loss was reasonably foreseeable or Xilinx had been advised of the possibility of the same. Xilinx assumes no obligation to correct any errors contained in the Materials or to notify you of updates to the Materials or to product specifications. You may not reproduce, modify, distribute, or publicly display the Materials without prior written consent. Certain products are subject to the terms and conditions of Xilinx's limited warranty, please refer to Xilinx's Terms of Sale which can be viewed at <https://www.xilinx.com/legal.htm#tos>; IP cores may be subject to warranty and support terms contained in a license issued to you by Xilinx. Xilinx products are not designed or intended to be fail-safe or for use in any application requiring fail-safe performance; you assume sole risk and liability for use of Xilinx products in such critical applications, please refer to Xilinx's Terms of Sale which can be viewed at <https://www.xilinx.com/legal.htm#tos>.

AUTOMOTIVE APPLICATIONS DISCLAIMER

AUTOMOTIVE PRODUCTS (IDENTIFIED AS "XA" IN THE PART NUMBER) ARE NOT WARRANTED FOR USE IN THE DEPLOYMENT OF AIRBAGS OR FOR USE IN APPLICATIONS THAT AFFECT CONTROL OF A VEHICLE ("SAFETY APPLICATION") UNLESS THERE IS A SAFETY CONCEPT OR REDUNDANCY FEATURE CONSISTENT WITH THE ISO 26262 AUTOMOTIVE SAFETY STANDARD ("SAFETY DESIGN"). CUSTOMER SHALL, PRIOR TO USING OR DISTRIBUTING ANY SYSTEMS THAT INCORPORATE PRODUCTS, THOROUGHLY TEST SUCH SYSTEMS FOR SAFETY PURPOSES. USE OF PRODUCTS IN A SAFETY APPLICATION WITHOUT A SAFETY DESIGN IS FULLY AT THE RISK OF CUSTOMER, SUBJECT ONLY TO APPLICABLE LAWS AND REGULATIONS GOVERNING LIMITATIONS ON PRODUCT LIABILITY.

© Copyright 2014–2017 Xilinx, Inc. Xilinx, the Xilinx logo, Artix, ISE, Kintex, Spartan, Virtex, Vivado, Zynq, and other designated brands included herein are trademarks of Xilinx in the United States and other countries. All other trademarks are the property of their respective owners.