

# **System Generator for DSP**

## ***Getting Started Guide***

UG639 (v 14.3) October 16, 2012

This document applies to the following software versions: ISE Design Suite 14.3 through 14.7



Xilinx is disclosing this user guide, manual, release note, and/or specification (the "Documentation") to you solely for use in the development of designs to operate with Xilinx hardware devices. You may not reproduce, distribute, republish, download, display, post, or transmit the Documentation in any form or by any means including, but not limited to, electronic, mechanical, photocopying, recording, or otherwise, without the prior written consent of Xilinx. Xilinx expressly disclaims any liability arising out of your use of the Documentation. Xilinx reserves the right, at its sole discretion, to change the Documentation without notice at any time. Xilinx assumes no obligation to correct any errors contained in the Documentation, or to advise you of any corrections or updates. Xilinx expressly disclaims any liability in connection with technical support or assistance that may be provided to you in connection with the Information.

THE DOCUMENTATION IS DISCLOSED TO YOU "AS-IS" WITH NO WARRANTY OF ANY KIND. XILINX MAKES NO OTHER WARRANTIES, WHETHER EXPRESS, IMPLIED, OR STATUTORY, REGARDING THE DOCUMENTATION, INCLUDING ANY WARRANTIES OF MERCHANTABILITY, FITNESS FOR A PARTICULAR PURPOSE, OR NONINFRINGEMENT OF THIRD-PARTY RIGHTS. IN NO EVENT WILL XILINX BE LIABLE FOR ANY CONSEQUENTIAL, INDIRECT, EXEMPLARY, SPECIAL, OR INCIDENTAL DAMAGES, INCLUDING ANY LOSS OF DATA OR LOST PROFITS, ARISING FROM YOUR USE OF THE DOCUMENTATION.

© Copyright 2006 - 2012. Xilinx, Inc. XILINX, the Xilinx logo, Artix, ISE, Kintex, Spartan, Virtex, and other designated brands included herein are trademarks of Xilinx in the United States and other countries. All other trademarks are the property of their respective owners.

---

# Table of Contents

---

## Chapter 1: Introduction

The Xilinx DSP Block Set .....	8
FIR Filter Generation.....	9
Support for MATLAB.....	10
System Resource Estimation.....	11
Hardware Co-Simulation.....	12
System Integration Platform.....	13

## Chapter 2: Installation

<b>Downloading</b> .....	15
Hardware Co-Simulation Support .....	15
UNC Paths Not Supported .....	15
<b>Using the ISE Design Suite Installer</b> .....	16
Choosing MATLAB for System Generator.....	16
<b>Post Installation Tasks</b> .....	17
Post-Installation Tasks on Linux .....	17
Troubleshooting a Linux Installation .....	17
Hardware Co-Simulation Installation.....	18
Compiling Xilinx HDL Libraries .....	19
Configuring the System Generator Cache .....	19
Displaying and Changing Versions of System Generator .....	20

## Chapter 3: Release Information

## Chapter 4: Getting Started

<b>Introduction</b> .....	23
<b>Lesson 1 - Design Creation Basics</b> .....	24
The System Generator Design Flow .....	24
The Xilinx DSP Blockset .....	25
Defining the FPGA Boundary .....	26
Adding the System Generator Token .....	27
Creating the DSP Design.....	28
Generating the HDL Code .....	29
Model-Based Design using System Generator .....	30
Creating Input Vectors using MATLAB.....	31
Lesson 1 Summary .....	32
Lab Exercise: Using Simulink .....	32
Lab Exercise: Getting Started with System Generator .....	32
<b>Lesson 2 - Fixed Point and Bit Operations</b> .....	33
Fixed-Point Numeric Precision .....	33
System Generator Fixed-Point Quantization .....	34
Overflow and Round Modes .....	35
Bit-Level Operations .....	36

The Reinterpret Block . . . . .	37
The Convert Block . . . . .	38
The Concat Block . . . . .	39
Slice Block . . . . .	40
The BitBasher Block . . . . .	41
Lesson 2 Summary . . . . .	42
Lab Exercise: Signal Routing . . . . .	42
<b>Lesson 3 - System Control . . . . .</b>	<b>43</b>
Controlling a DSP System . . . . .	43
The MCode Block . . . . .	44
The Xilinx “xl_state” Data Type . . . . .	45
State Machine Example . . . . .	46
The Expression Block . . . . .	47
Reset and Enable Ports . . . . .	48
Bursty Data . . . . .	49
Lesson 3 Summary . . . . .	50
Lab Exercise: System Control . . . . .	50
<b>Lesson 4 - Multi-Rate Systems . . . . .</b>	<b>51</b>
Creating Multi-Rate Systems . . . . .	51
Up and Down Sampling Blocks . . . . .	52
Rate Changing Functional Blocks . . . . .	53
Viewing Rate Changes in Simulink . . . . .	54
Debugging Tools . . . . .	55
Sample Period “Rules” . . . . .	56
Lab Exercise: Multi-Rate Systems . . . . .	57
<b>Lesson 5 - Using Memories . . . . .</b>	<b>58</b>
Block vs. Distributed RAM . . . . .	58
Initializing RAMs and ROMs . . . . .	59
System Generator RAM Blocks . . . . .	60
System Generator ROM Blocks . . . . .	61
The Delay Block . . . . .	62
The FIFO Block . . . . .	63
Shared Memory Block . . . . .	64
Lab Exercise: Using Memories . . . . .	65
<b>Lesson 6 - Designing Filters . . . . .</b>	<b>66</b>
Introduction . . . . .	66
The Virtex DSP48 Math Slice . . . . .	67
FIR Compiler Block . . . . .	68
Creating Coefficients with FDA Tool . . . . .	69
Using FDA Tool Coefficients . . . . .	70
Lab Exercise: Designing Filters . . . . .	71
<b>Additional Examples and Tutorials . . . . .</b>	<b>72</b>
AXI4 Conversion Examples . . . . .	72
Black Box Examples . . . . .	72
ChipScope Examples . . . . .	73
DSP Examples . . . . .	73
M-Code Examples . . . . .	74
Processor Examples . . . . .	75
Shared Memory Examples . . . . .	75
Miscellaneous Examples . . . . .	76
System Generator Demos . . . . .	77

**Index** ..... 79



## Introduction

System Generator is a DSP design tool from Xilinx that enables the use of the MathWorks model-based Simulink® design environment for FPGA design. Previous experience with Xilinx FPGAs or RTL design methodologies are not required when using System Generator. Designs are captured in the DSP friendly Simulink modeling environment using a Xilinx specific blockset. All of the downstream FPGA implementation steps including synthesis and place and route are automatically performed to generate an FPGA programming file.

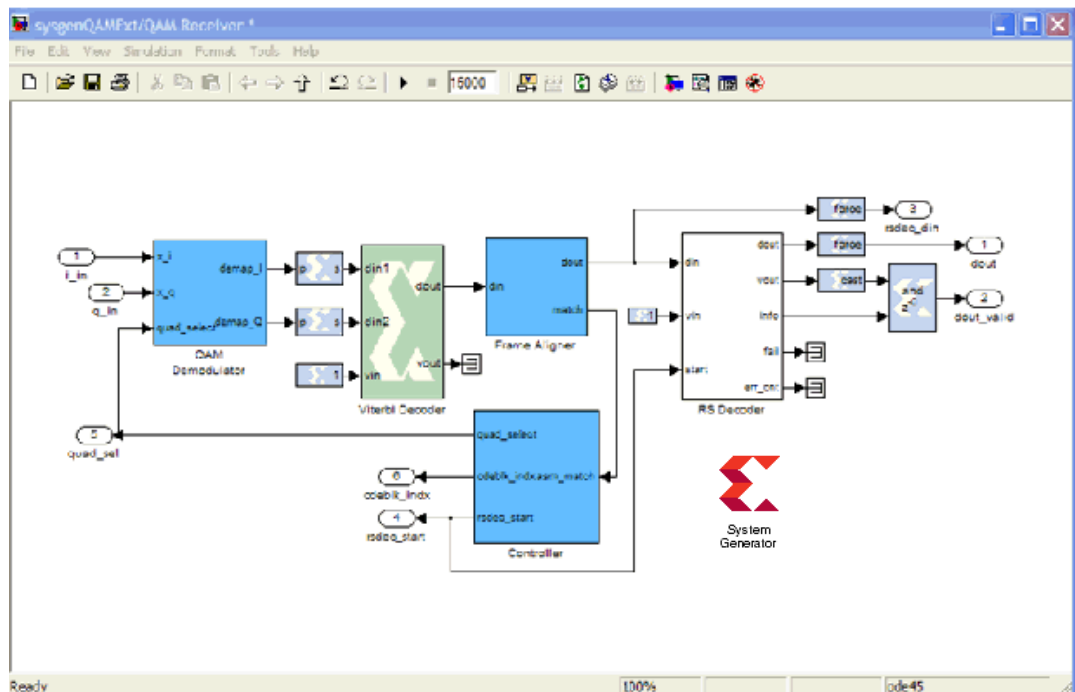

## The Xilinx DSP Block Set

Over 90 DSP building blocks are provided in the Xilinx DSP blockset for Simulink. These blocks include the common DSP building blocks such as adders, multipliers and registers. Also included are a set of complex DSP building blocks such as forward error correction blocks, FFTs, filters and memories. These blocks leverage the Xilinx IP core generators to deliver optimized results for the selected device.

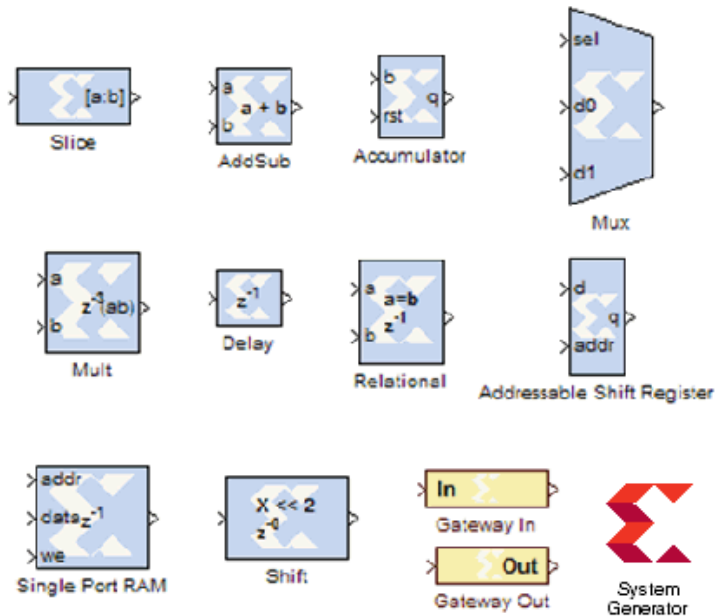



# FIR Filter Generation

System Generator includes a FIR Compiler block that targets the dedicated DSP48 hardware resources in the Virtex®-4 and Virtex-5 devices to create highly optimized implementations that can run in excess of 500 Mhz. Configuration options allow generation of direct, polyphase decimation, polyphase interpolation and oversampled implementations. Standard MATLAB functions such as fir2 or the MathWorks FDAtool can be used to create coefficients for the Xilinx FIR Compiler.

## FIR Compiler

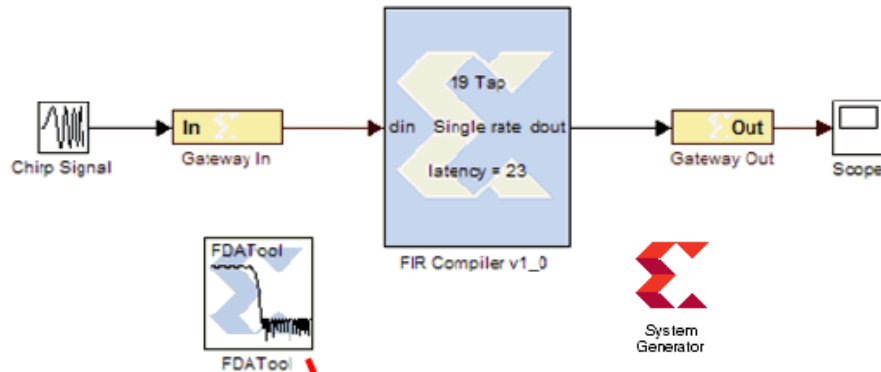

## FDA Tool

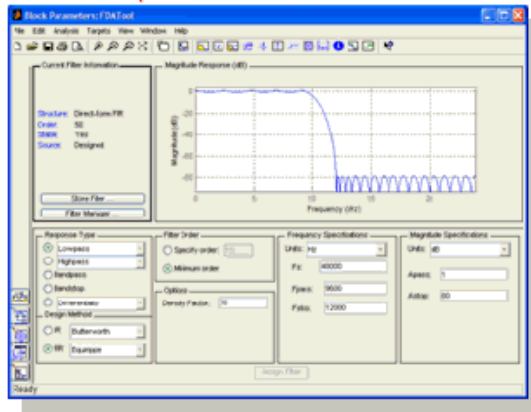

## Support for MATLAB

Included in System Generator is an MCode block that allows the use of non-algorithmic MATLAB for the modeling and implementation of simple control operations.

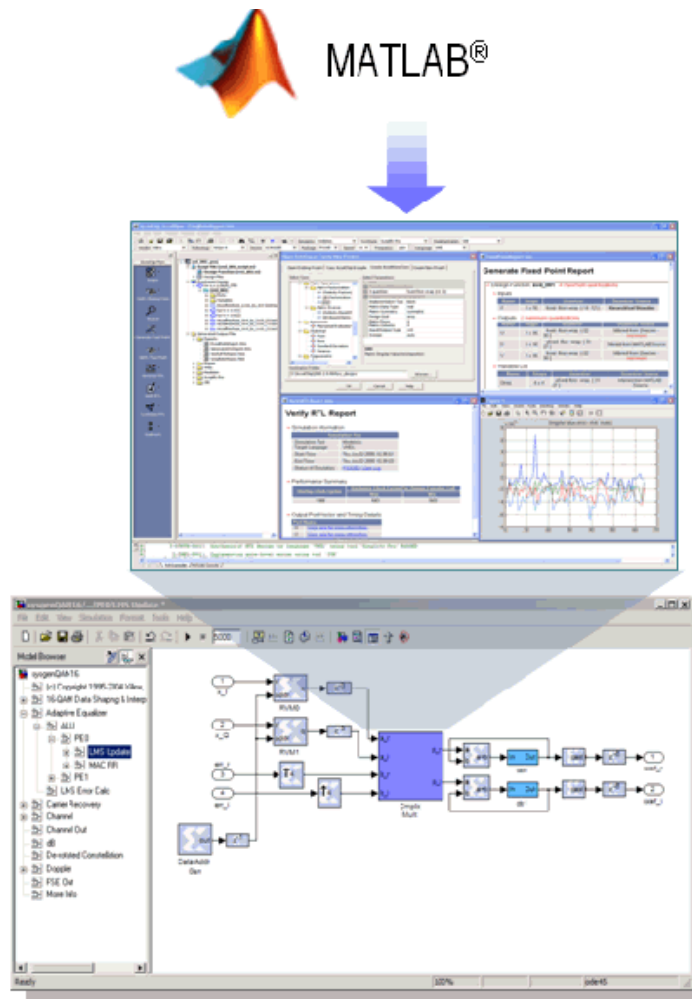

## System Resource Estimation

System Generator provides a Resource Estimator block that quickly estimates the area of a design prior to place and route. This can be a valuable aid in the hardware / software partitioning process by helping system designers take full advantage of the FPGA resources which include up to 640 multiply/accumulate (or DSP) blocks in the Virtex®-5 devices.

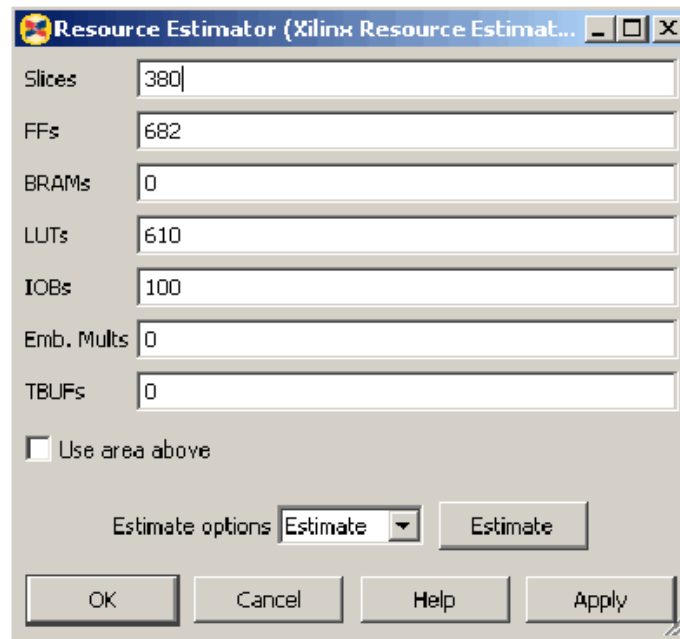

The screenshot shows the 'Resource Estimator' dialog box with the following fields and controls:

Resource	Value
Slices	380
FFs	682
BRAMs	0
LUTs	610
IOBs	100
Emb. Mults	0
TBUFs	0

Use area above

Estimate options: Estimate (dropdown) Estimate (button)

Buttons: OK, Cancel, Help, Apply

## Hardware Co-Simulation

System Generator provides accelerated simulation through hardware co-simulation. System Generator will automatically create a hardware simulation token for a design captured in the Xilinx DSP blockset that will run on one of over 20 supported hardware platforms. This hardware will co-simulate with the rest of the Simulink system to provide up to a 1000x simulation performance increase.

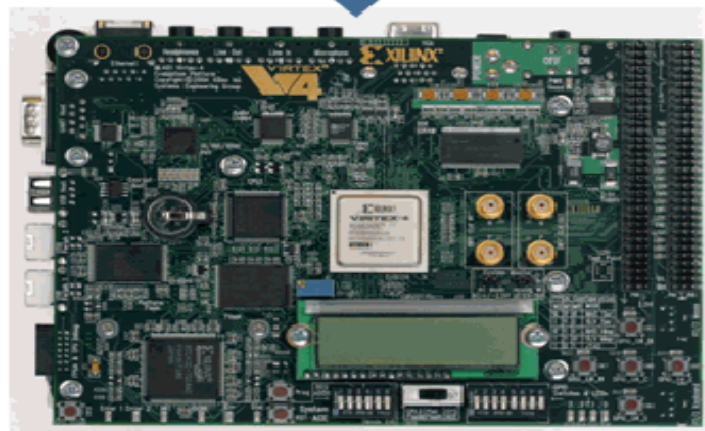
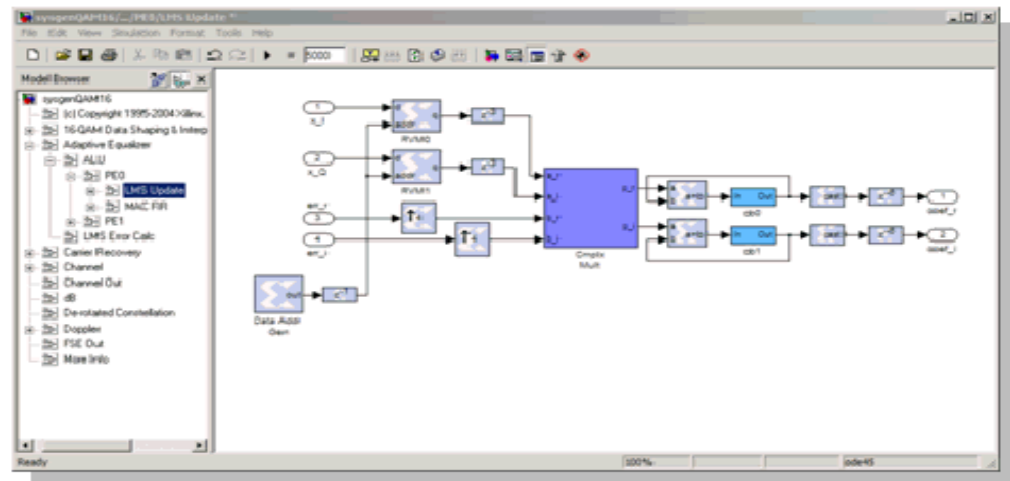

## System Integration Platform

System Generator provides a system integration platform for the design of DSP FPGAs that allows the RTL, Simulink, MATLAB and C/C++ components of a DSP system to come together in a single simulation and implementation environment. System Generator supports a black box block that allows RTL to be imported into Simulink and co-simulated with either ModelSim or Xilinx® ISE® Simulator. System Generator also supports the inclusion of a MicroBlaze® embedded processor running C/C++ programs.

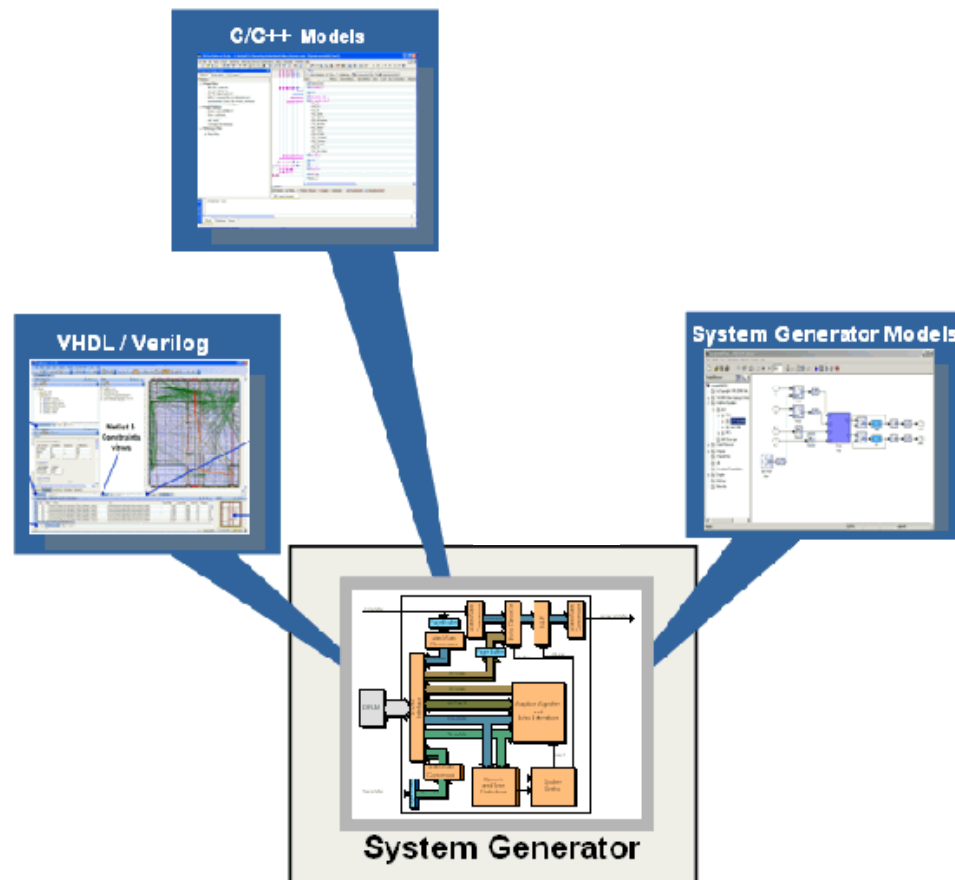



# Installation

---

## Downloading

System Generator is part of the ISE® Design Suite and may be download from the Xilinx web page. You may purchase, register, and download the System Generator software from the site at:

<http://www.xilinx.com/tools/sysgen.htm>

**Note:** In special circumstances, System Generator can be delivered on a CD. Please contact your Xilinx distributor if your circumstances prohibit you from downloading the software via the web.

## Hardware Co-Simulation Support

If you have an FPGA development board, you may be able to take advantage of System Generator's ability to use FPGA hardware co-simulation with Simulink simulations. The System Generator software includes support for the XtremeDSP Development Kit, the MicroBlaze™ Multimedia Demonstration boards, the MVI hardware platform, the ML402 Virtex®-4 Board, the ML506 Virtex-5 Board, the ML605 Virtex-6 Board, the Spartan-3A DSP 1800 Starter Board, the Spartan-3A DSP 3400 Development Board, and the Spartan-6 SP601/SP605 Board. Additional System Generator board support packages provide support for additional hardware co-simulation boards. System Generator board support packages can be downloaded from the following URL:

[http://www.xilinx.com/products/boards\\_kits/index.htm](http://www.xilinx.com/products/boards_kits/index.htm)

## UNC Paths Not Supported

System Generator does not support UNC (Universal Naming Convention) paths. For example System Generator cannot operate on a design that is located on a shared network drive without mapping to the drive first.

## Using the ISE Design Suite Installer

System Generator for DSP is part of the Xilinx ISE® Design Suite and you must use the ISE Design Suite installer to install System Generator.

Before invoking the ISE Design Suite installer, it is a good idea to make sure that all instances of MATLAB are closed. When all instances of MATLAB are closed, launch the installer and follow the directions on the screen.

### Choosing MATLAB for System Generator

#### Windows Installations

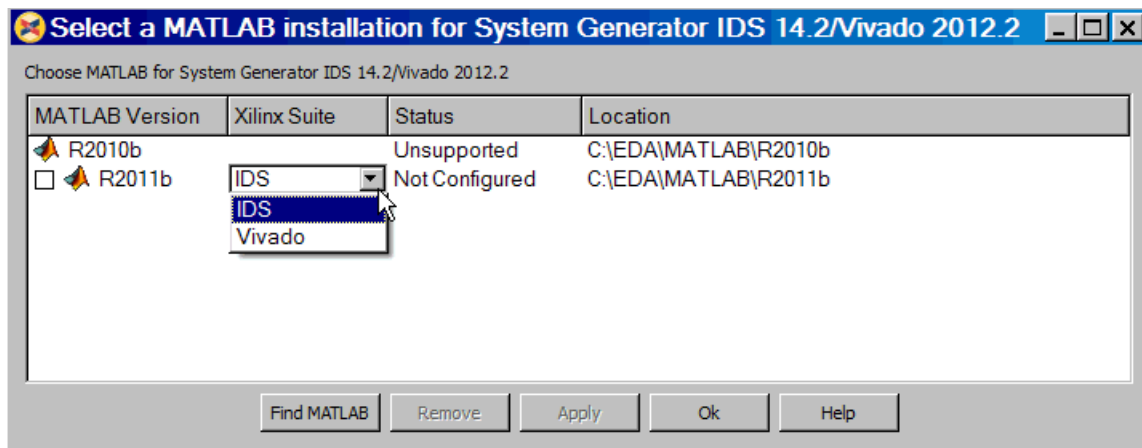

This dialog box allows you to associate any supported MATLAB installation with this version of System Generator.

Click the check box of the MATLAB installation(s) you wish to associate with this version of System Generator, select the Xilinx Design Suite you wish to associate with, then click **Apply**. Once the Apply operation is completed, the value in the Status column changes from “Not Configured” to “Configured”.

The application lists all the available MATLAB installations. The Status field shows one of the following values:

**Unsupported:** This version of MATLAB is not supported with this version of System Generator.

**Not Configured:** This version of MATLAB is not yet associated with this version of System Generator. To associate this version of MATLAB with System Generator, click the check box and then click **Apply**.

**Configured:** System Generator is now ready to be used with this version of MATLAB.

If you don't see a version of MATLAB listed, click **Find MATLAB** to browse for a valid version.

If you wish to change the MATLAB configuration, select the following Windows menu item:

**Start > All Programs > Xilinx Design Tools > ISE Design Suite > System Generator > System Generator MATLAB Configurator.**



If MATLAB is configured for a Design Suite, say IDS, and you wish to re-configure MATLAB for another Design Suite, say Vivado, you must select the Configured MATLAB version box and click **Remove** before you re-configure for Vivado.

## Linux Installations

Launching System Generator under Linux is handled via a shell script called “sysgen” located in the <IDS install dir>/sysgen/util directory. Since System Generator supports both ISE and Vivado, a command line option has been made available to subscribe to the Vivado specific blockset(s) supported by System Generator. Without any command line arguments, System Generator will use ISE supported blockset(s) within MATLAB. Using the ‘-v’ option forces System Generator into Vivado mode. When MATLAB opens, text detailing which blockset(s) will be shown as below will be to indicate which version of the tool suite is used.

*Using Vivado enabled System Generator*

or

*Using ISE enabled System Generator*

This message on the MATLAB console will be seen as part of the dynamic installation of System Generator into MATLAB.

## Post Installation Tasks

### Post-Installation Tasks on Linux

After following the directions of the main ISE Design Suite Installation Wizard, you are ready to launch System Generator by typing: `sysgen`

**Note:** This will invoke MATLAB and dynamically add System Generator to that MATLAB session. At the top of the MATLAB Command Window, you should see the “Installed System Generator dynamically” messages. You are now ready to run System Generator.

The following is an expected message under certain conditions. If System Generator is already installed when this script runs, you will see the following message:

```
System Generator currently found installed into matlab
default path.
```

### Troubleshooting a Linux Installation

The following four functions are used to troubleshoot and verify the Linux Installation.

#### `xl_get_matlab_support_xmlfile`

This MATLAB function will retrieve the expected location of the common XML file used for determining MATLAB support within System Generator.

#### `xl_verify_matlab_support_xmlfile <pathname_to_xmlfile>`

This matlab function will verify that the specified XML file exists and is readable. If no XML file exists, the following error message is thrown to the MATLAB console”

```
Could not find ml_supported.xml to determine supported versions
of MATLAB with System Generator.
```

If the XML file is unreadable, the error message that is thrown to the MATLAB console is:

```
Could not read ml_supported.xml to determine supported versions
of MATLAB with System Generator
```

### **xl\_read\_matlab\_support\_xmlfile**

This MATLAB function reads and parses the XML file looking for the supported MATLAB version information and provides error/warning messages used by the `sysgen_startup.m` script.

### **xl\_test\_matlab\_support\_xmlfile**

This MATLAB function tests the current instantiated MATLAB session and compares its version to those which are supported. Errors or warnings will be displayed based on results of this comparison. If the XML file is devoid of information, the error thrown to the MATLAB console is as follows:

```
Matlab support table used by System Generator is empty!
```

If the XML file information does not conform to the expected format, the following error is thrown to the MATLAB console:

```
Input matlab support table is not well formed. It should have
only 2 columns!
```

If you are using a version of MATLAB that is too old (unsupported), then you will see the following error messages:

```
System Generator will not properly function under this version
of MATLAB!
```

```
Error occurred while attempting to install System Generator into
MATLAB path.
```

If you are using a version of MATLAB that is too new, then you will see the following warning messages:

```
System Generator may not properly function under this version of
MATLAB!
```

## Hardware Co-Simulation Installation

This topic provides links to hardware and software installation procedures for hardware co-simulation. If you do not plan to use hardware co-simulation, you may skip this topic.

### Ethernet-Based Hardware Co-Simulation

[Installing an ML402 Board for Ethernet Hardware Co-Simulation](#)

[Installing an ML560 Board for Ethernet Hardware Co-Simulation](#)

[Installing an ML650 Board for Ethernet Hardware Co-Simulation](#)

[Installing a Spartan-3A DSP 1800A Starter Board for Ethernet Hardware Co-Simulation](#)

[Installing a Spartan-3A DSP 3400A Development Board for Ethernet Hardware Co-Simulation](#)

### [Installing an SP601/SP605 Board for Ethernet Hardware Co-Simulation](#)

**Note:** If installation instructions for your particular platform are not provided here, please refer to the installation instructions that come with your Platform Kit. For instructions on how to install a Xilinx USB Cable and cable driver software on a Windows or Linux Operating System, refer to the Xilinx document titled: [USB Cable Installation Guide](#)

## JTAG-Based Hardware Co-Simulation

[Installing an ML402 Board for JTAG Hardware Co-Simulation](#)

[Installing an ML605 Board for JTAG Hardware Co-Simulation](#)

[Installing an SP601/SP605 Board for JTAG Hardware Co-Simulation](#)

[Installing a KC705 Board for JTAG Hardware Co-Simulation](#)

## Third-Party Hardware Co-Simulation

As part of the Xilinx XtremeDSP™ Initiative, Xilinx works with distributors and many OEMs to provide a variety of DSP prototyping and development platforms. Please refer to the following Xilinx web site page for more information on available platforms:  
[http://www.xilinx.com/products/boards\\_kits/index.htm](http://www.xilinx.com/products/boards_kits/index.htm)

## Compiling Xilinx HDL Libraries

If you intend to simulate System Generator designs using ModelSim, you must compile your IP (cores) libraries. This topic describes the procedure.

### ModelSim SE

The Xilinx tool that compiles libraries for use in ModelSim SE is named **compplib**. The following command can, for example, be used to compile all the VHDL and Verilog libraries with ModelSim SE:

```
compplib -s mti_se -f all -l all
```

Complete instructions for running compplib can be found in the ISE Software Manual titled "Command Line Tool User Guide".

## Configuring the System Generator Cache

Both the System Generator simulator and the design generator incorporate a disk cache to speed up the iterative design process. The cache does this by tagging and storing files related to simulation and generation, then recalling those files during subsequent simulation and generation rather than rerunning the time consuming tools used to create those files.

### Setting the Size

By default, the cache will use up to 500 MB of disk space to store files. To specify the amount of disk space the cache should use, set the SYSGEN\_CACHE\_SIZE environment variable to the size of the cache in megabytes. Set this number to a higher value when working on several large designs.

## Setting the Number of Entries

The cache entry database stores a fixed number of entries. The default is 20,000 entries. To set size of the cache entry database, set the `SYSGEN_CACHE_ENTRIES` environment variable to the desired number of entries. Setting this number too small will adversely affect cache performance. Set this number to a higher value when working on several large designs.

You can use the `xlCache` function to manage and inspect the properties of difference caches used by System Generator. A detailed description of this function can be found under the topic [System Generator Utilities](#).

## Displaying and Changing Versions of System Generator

It is possible to have several versions of System Generator installed. The MATLAB command `xlVersion` displays which versions are installed, and makes it possible to switch from one to another. `xlVersion` is useful when upgrading a model to run in the latest version of System Generator.

Entering "xlVersion" in the MATLAB console displays the version of System Generator that is installed.

```
Available System Generator installations:  
Version 14.1.4301 in C:/Xilinx/14.1/ISE_DS/ISE/sysgen  
Current version of System Generator is 14.1.4301
```

## *Release Information*

---

System Generator for DSP release information can now be found in the following Web-based document:

[Xilinx Design Tools: Release Notes Guide](#)



# Getting Started

---

## Introduction

This Getting Started training consists of six short lessons that introduce you to major features of System Generator for DSP. Each lesson takes less than 10 minutes to read and is followed by one or more hands-on lab exercises. The lab exercise folders are located in the System Generator software tree and contain data files and step-by-step instructions.

If you have System Generator installed on your computer, you can complete each lab exercise at your own pace and on your own time schedule. If you do not have System Generator installed, you can access this free training in a recorded e-learning format through the Xilinx web site at the following location:

<http://www.xilinx.com/support/training/rel/system-generator.htm>

The lessons contained in this Getting Started are as follows:

- **Lesson 1 - Design Creation Basics:** Introduces the basics of creating and implementing a DSP design using System Generator.
- **Lesson 2 - Fixed Point and Bit Operations:** Covers the use of the System Generator routing blocks for extracting and manipulating the individual bits of a fixed-point signal.
- **Lesson 3 - System Control:** Covers the preferred methods for using System Generator to create finite state machines, logical control conditions, and the handling of bursty data typical of FFT and filtering operations.
- **Lesson 4 - Multi-Rate Systems:** Shows the proper way to create multi-rate systems using upsampling and downsampling of data.
- **Lesson 5 - Using Memories:** Covers proper usage of the Xilinx block RAM resources and the DSP blocks available for building DSP designs targeting Xilinx RAMs.
- **Lesson 6 - Designing Filters:** Discusses methods for creating efficient FIR filters in the Xilinx devices, use of the FIR Compiler block for filter implementation, and use of the FDATool for filter design.

## Lesson 1 - Design Creation Basics

### The System Generator Design Flow

System Generator works within the Simulink model-based design methodology. Often an executable spec is created using the standard Simulink block sets. This spec can be designed using floating-point numerical precision and without hardware detail. Once the functionality and basic dataflow issues have been defined, System Generator can be used to specify the hardware implementation details for the Xilinx devices. System Generator uses the Xilinx DSP blockset for Simulink and will automatically invoke Xilinx Core Generator™ to generate highly-optimized netlists for the DSP building blocks. System Generator can execute all the downstream implementation tools to product a bitstream for programming the FPGA. An optional testbench can be created using test vectors extracted from the Simulink environment for use with ModelSim or the Xilinx ISE® Simulator.

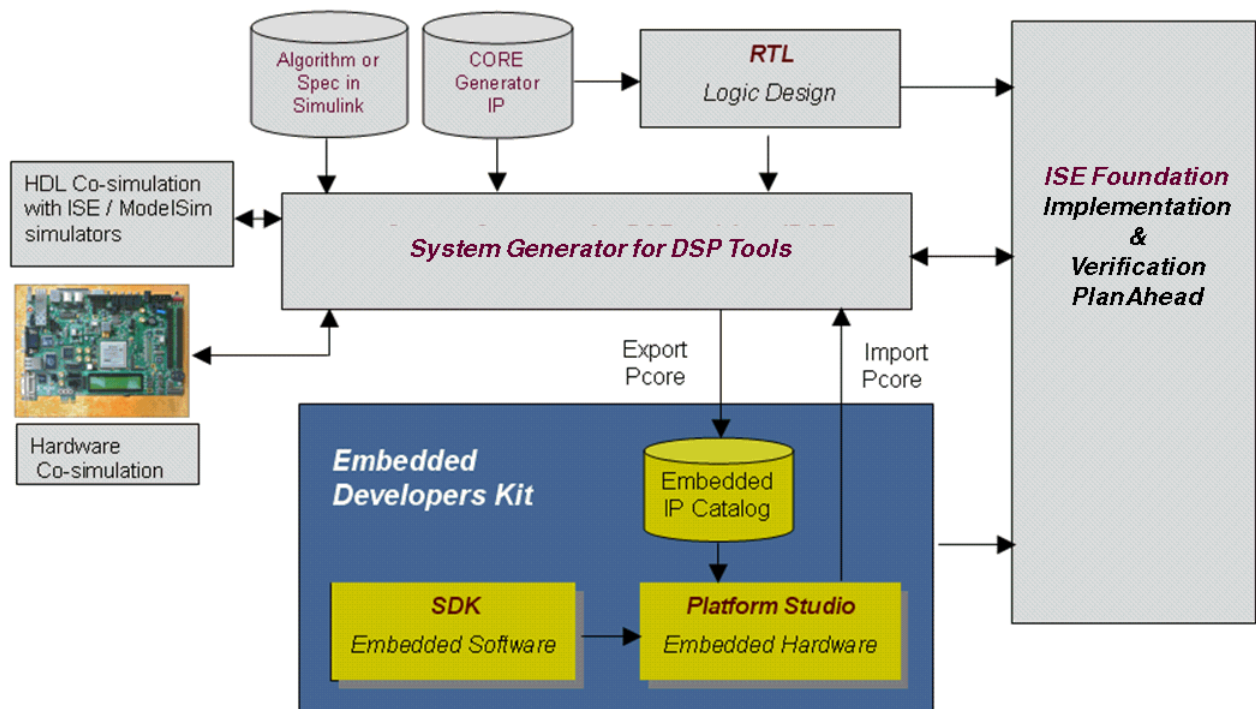



## The Xilinx DSP Blockset

The Xilinx DSP blockset is accessed via the Simulink Library browser which can be launched from the standard MATLAB toolbar. The blocks are separated into sub-categories for easier searching. One sub-category, "Index" includes all the block and is often the quickest way to access a block you are already familiar with. Over 90 DSP building blocks are available for constructing your DSP system.

**NOTE:** It is important that you don't name your design the same as a Xilinx block. For example, if you name your design `shared_memory.mdl`, it may cause System Generator to issue an error message.

# The Xilinx DSP Blockset

- Over 90 DSP building blocks available
- Blocks are accessed through the Simulink Library Browser
  - This can be launched from the MATLAB toolbar

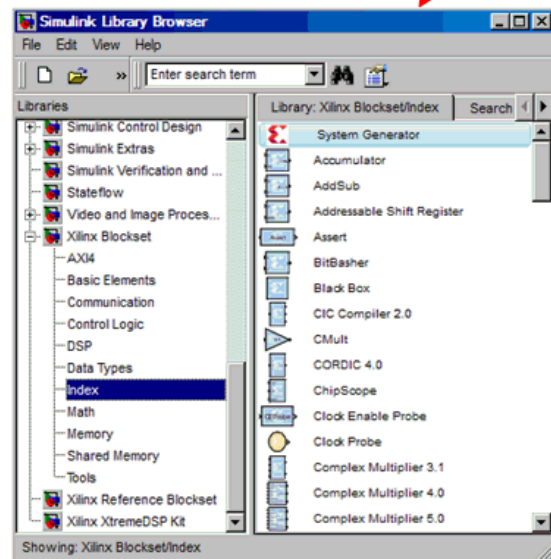
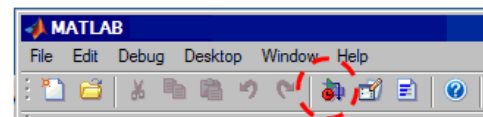

Each block has a background color that indicates the following:

Background Color	Meaning
Blue	Block Goes into the FPGA fabric and is free!!
Green	Block Goes into the FPGA fabric and is a Pay Core/Licensed. Go to the Xilinx web site to purchase the Core license.
Yellow	Blocks on the boundary of your design like Gateway, Shared Memory Read, Shared Memory Write, VDMA, etc
White	Utility or Tool
Red Symbol	System Generator Token (control panel)

## Defining the FPGA Boundary

System Generator works with standard Simulink models. Two blocks called “Gateway In” and “Gateway Out” define the boundary of the FPGA from the Simulink simulation model. The Gateway In block converts the floating point input to a fixed-point number. You double-click on the block to bring up the properties editor which is where the fixed-point number can be fully specified.

# Defining the FPGA Boundary

- The FPGA boundary is defined by the Xilinx “Gateway In” and “Gateway Out” blocks
- The “Gateway In” block converts the floating-point input to fixed-point
  - Saturation and rounding modes are defined
- The “Gateway Out” block converts the FPGA outputs back to double precision

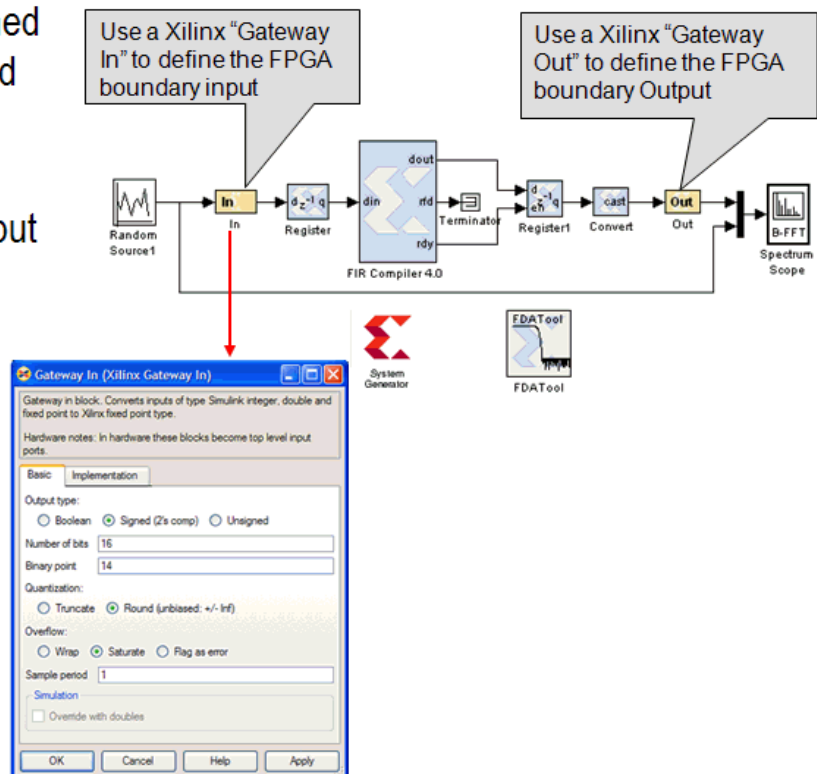

## Adding the System Generator Token

Every System Generator diagram requires that at least one System Generator token be placed on the diagram. This token is not connected to anything but serves to drive the FPGA implementation process. The property editor for this token allows you to specify the target netlist, device, performance targets and system period. System Generator will issue an error if this token is absent.

# Adding The System Generator Token

- Every design must include a System Generator Token
- Sets the global netlisting options required for FPGA implementation
  - Target device
  - VHDL / Verilog RTL
  - Clock performance requirements
  - Downstream toolflow

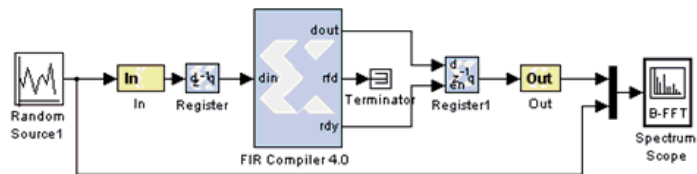

Each System Generator design must include the "System Generator" Token

The Simulink System Period must be set correctly for simulation to work

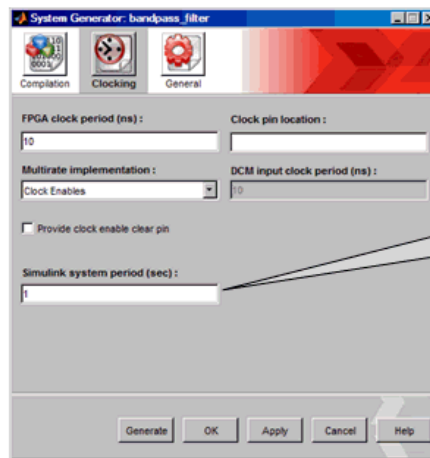

## Creating the DSP Design

Once the FPGA boundaries have been established using the Gateway blocks, the DSP design can be constructed using blocks from the Xilinx DSP blockset. Standard Simulink blocks are not supported for use within the Gateway In / Gateway out blocks. You will find a rich set of filters, FFTs, FEC cores, memories, arithmetic, logical and bitwise blocks available for use in constructing DSP designs. Each of these blocks are cycle and bit accurate.

# Creating the DSP Design

- All the blocks in the Xilinx DSP blockset are available for creating DSP designs targeting FPGAs
  - Over 90 blocks are available
  - Basic building blocks such as arithmetic and logical operators
  - System Generator IP blocks such as FIR compiler, FFT, CIC compiler and etc...
- These blocks leverage Xilinx IP generators to produce optimal results for Xilinx devices

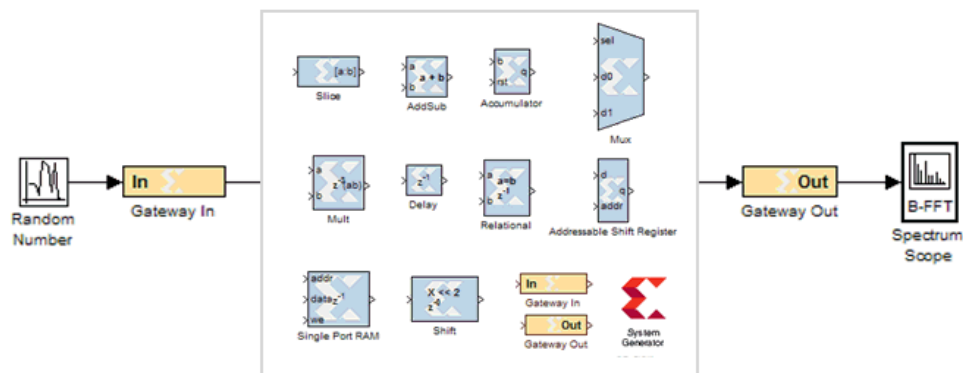

## Generating the HDL Code

Once the design is completed, the hardware implementation files can be generated using the **Generate** button available on the System Generator token properties editor. One option is to select **HDL Netlist** which allows the FPGA implementation steps of RTL synthesis and place and route to be performed interactively using tool specific user interfaces. Alternatively, you can select **Bitstream** as the Compilation target and System Generator will automatically perform all implementation steps.

# Generating the HDL Code

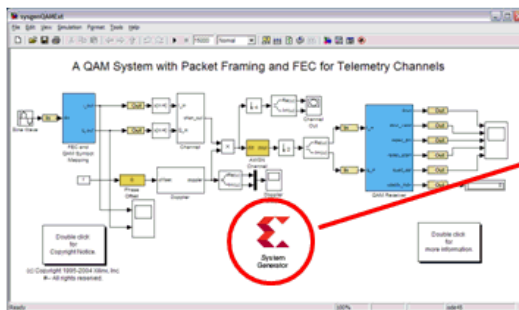

Once complete, double-click the System Generator token

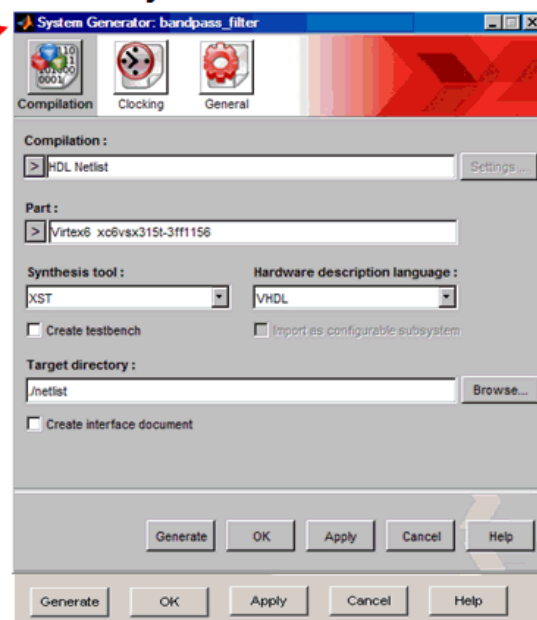

- Select **HDL Netlist** as the compilation mode
- Select the target part
- Set HDL language
- Set the **FPGA Clock Period**
- Check **Create Testbench**
- **Generate** the HDL

If the **Create Testbench** option is selected, then System Generator will save and write test vector files that are extracted from the Simulink simulation and generate an HDL testbench and script files for ModelSim. This is an optional step that simply verifies that the generated hardware is functionally equivalent to the Simulink simulation. The script files must be used with ModelSim interactively.

## Model-Based Design using System Generator

Model-based design refers the design practice of creating a high-level executable specification using the standard Simulink blocksets or MATLAB first to define the desired functional behavior with minimal hardware detail. This executable spec is then used as a reference model while the hardware representation is specified using the Xilinx DSP blockset.

## Model-Based Design using System Generator

- System Generator extends the model based design environment of Simulink for FPGA Design
  - First develop a high-level executable spec using standard Simulink blocks
  - Create an FPGA specific implementation using System Generator
  - Use Simulink to compare for functional and fixed-point differences

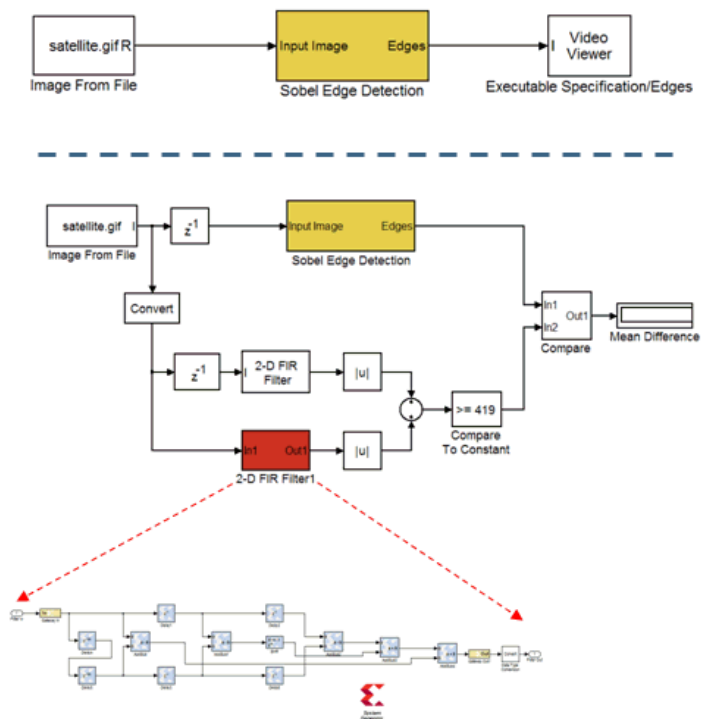

## Creating Input Vectors using MATLAB

Simulink is built on top of MATLAB allowing the use of the full MATLAB language for input signal generation and output analysis. You can use the "From Workspace" and "To Workspace" blocks from the Simulink Source and Sink libraries. Input values must be specified as an n rows x 2 column matrix where the first column is the simulation time and the second column includes the input values. This is a very popular way to generate input vectors for System Generator designs.

- The Simulink "From Workspace" block provides a convenient way to generate input stimulus for Simulink designs

- Data must be in the form of a 2xn matrix
  - Column 1 = time values
  - Column 2 = data values
- Often this is a more descriptive approach and does not require sourcing a MATLAB file prior to simulation

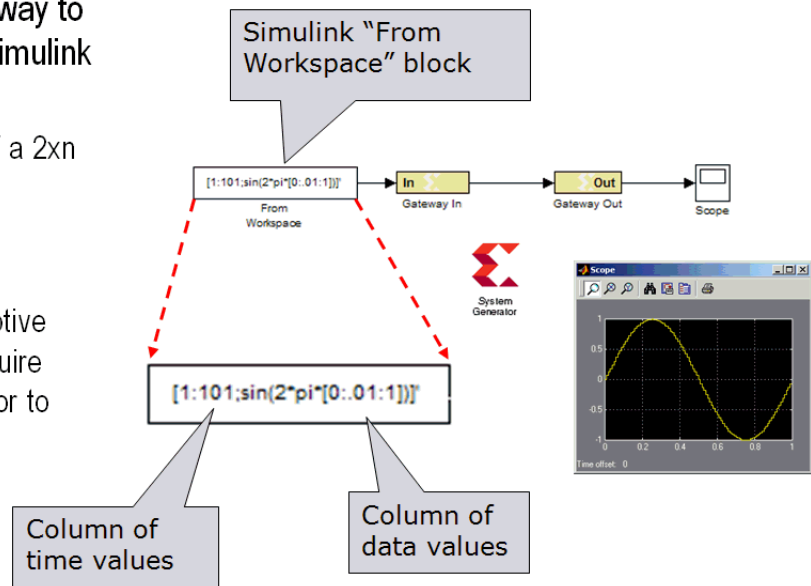

## Lesson 1 Summary

- You partition the FPGA design from the Simulink “system” using Gateway In / Gateway Out blocks.
- You always include a System Generator token on each sheet
- You should only use blocks from the Xilinx DSP blockset between the gateway blocks
- You should consider using the From / To workspace blocks to use MATLAB for input generation and output analysis

## Lab Exercise: Using Simulink

In this lab, you will learn the basics of Simulink. You will use a Simulink blockset to generate a simple design and take it through simulation. You will then change the sampling settings to see its effect on the output. You will then learn how to create a subsystem.

The lab instructions are located in the System Generator software tree at the following pathname:

```
<ISE_Design_Suite_tree>/sysgen/examples/getting_started_training/lab1/lab1.pdf
```

## Lab Exercise: Getting Started with System Generator

This lab introduces you to the basic concepts of creating a design using System Generator within the model-based design flow provided through Simulink. The design is a simple multiply-add circuit.

The lab instructions and lab design are located in the System Generator software tree at the following pathname:

```
<ISE_Design_Suite_tree>/sysgen/examples/getting_started_training/lab2/
```



## Lesson 2 - Fixed Point and Bit Operations

### Fixed-Point Numeric Precision

System Generator supports four data types, **Unsigned** for positive only DSP operations, **Signed** which is two's complement used for DSP operations that involve negative numbers, **Boolean** for 1-bit control signals and **Floating-Point**. Each block will typically have quantization parameters. The initial quantization is defined by the Gateway In blocks.

## Fixed-Point Numeric Precision

- The Xilinx "Gateway In" block will convert the Simulink "double" datatype to fixed-point numeric precision
  - Fixed-point arithmetic trades off numerical precision for hardware efficiency
- System Generator supports unsigned (ufixed) and two's complement (fixed)
  - Use "fixed" for negative numbers
    - Reduced dynamic range

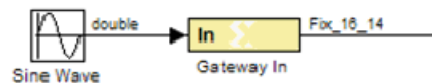

#### UNSIGNED

Decimal	Bit Pattern
15	1111
14	1110
13	1101
12	1100
11	1011
10	1010
9	1001
8	1000
7	0111
6	0110
5	0101
4	0100
3	0011
2	0010
1	0001
0	0000

#### TWO'S COMPLEMENT

Decimal	Bit Pattern
7	0111
6	0110
5	0101
4	0100
3	0011
2	0010
1	0001
0	0000
-1	1111
-2	1110
-3	1101
-4	1100
-5	1011
-6	1010
-7	1001
-8	1000

## System Generator Fixed-Point Quantization

Xilinx fixed-point data types are defined by specifying the total number of bits then specifying the location of the binary point. The difference, which represents the number of bits to the left of the binary point, are the integer bits for unfixed numbers and the integer bits plus sign bit for signed numbers. Xilinx FPGAs do not require that fixed-point numbers fall in pre-defined 8 bit boundaries as is the case with DSP processors. The logic can grow bit-by-bit to accommodate the required fixed-point precision.

### System Generator Fixed-Point Quantization

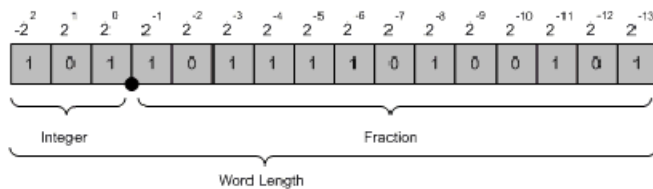

- **System Generator supports the following fixed-point data types**
  - Signed (2's Complement)
    - Required for negative numbers
  - Unsigned
    - Provides a greater range with same hardware when numbers are all positive
- **To optimize the dynamic range of a number**
  - Use a minimal # of integer bits to accommodate the range of possible values
  - Use a minimal # of fraction bits to accommodate acceptable precision

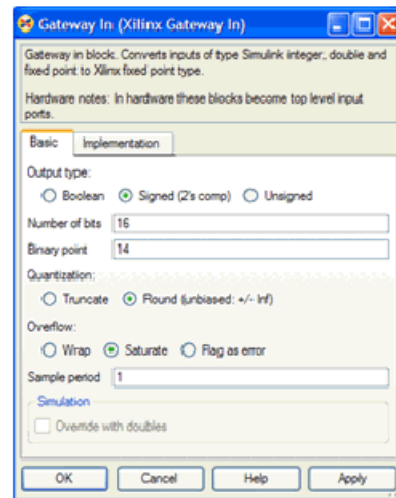

Fractional Bits	Fractional Values Available
1	0, 0.5
2	0, 0.25, 0.5, 0.75
3	0.125, 0.25, 0.375, 0.5, 0.625, 0.75, 0.875

## Overflow and Round Modes

System Generator supports the overflow modes **Wrap**, **Saturate** and **Flag as error**. **Wrap** is the default because it has the least cost in hardware. **Saturate** requires System Generator to insert logic to perform that operation and therefore should only be used when necessary for the application

System Generator supports **Truncate** and **Round** of the LSB during the quantization process. Similar to the **Wrap** mode for overflow mode, **Truncate** has minimal hardware cost and is the default. Specifying the **Round** mode requires System Generator to insert extra logic and should be used when only necessary for the application.

# Overflow and Round Modes

### Overflow

- Defines how System Generator handles the MSB of a number
  - When a number is too large to be represented by the integer bits of a number
- Wrap – the MSB’s are dropped
  - Simple to implement in hardware
- Saturate – The result is set to the maximum value
  - Requires additional logic

### Round Mode

- Defines how System Generator handles the LSB of a number
  - When a floating-point number is converted to fixed-point, “unnecessary” precision is lost
- Users must decide to “cut the precision off” (truncate) or to round to the nearest precision value (round)

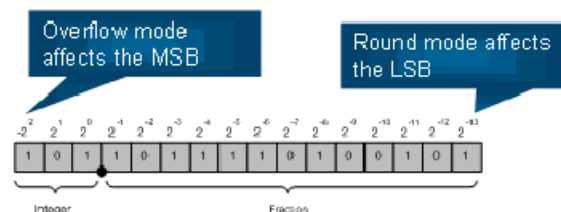
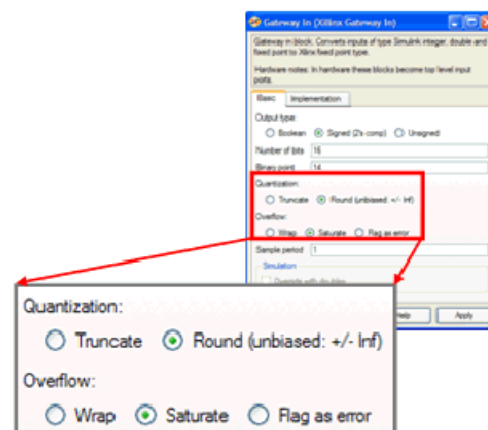

## Bit-Level Operations

In a real DSP hardware system, not all operations can be expressed mathematically. Often a signal must be accessed by its individual bits. System Generator supports a set of bit-level operations that allow the reinterpret, combining, conversion and extraction of the individual bits of a signal. This can be used to pad, unpad and slice off the bits of a signal with a high degree of control. These blocks do not use any hardware resources

# Bit-level Operations

- Implementing a DSP design in hardware will typically require some operations to be performed at the bit level
- System Generator support blocks to perform the following bit-level operations:
  - **Reinterpret** unsigned data as signed or the converse
  - **Combine** two data buses together to form a new bus
  - **Convert** a fixed-point data type to a new fixed-point data type
  - **Extract** certain bits of data, especially when there is bit growth

## The Reinterpret Block

The Reinterpret block forces the bits of a signal to a new type without regard for the numerical value or location of the decimal point. This block does not change the number of bits of a signal but simply reinterprets the data type. For example if the number 4 is represented as an unsigned [4 1] it is 1000. If this number is reinterpreted to be unsigned [4 0], the 1000 is now 8.

# Reinterpret Block

- Forces the output to a new type without regard for the numerical value represented by the input
- The total number of bits in = total number of bits out
- Allows unsigned data to be reinterpreted as signed data and the converse
- Allows scaling of the data through repositioning of the binary point
  - '1000' quantized to unsigned [4 1] = 4
  - '1000' reinterpreted to unsigned [4 0] = 8

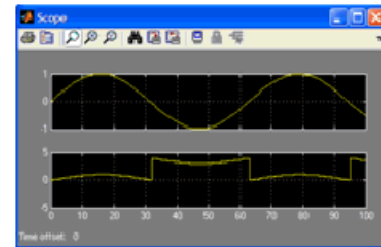
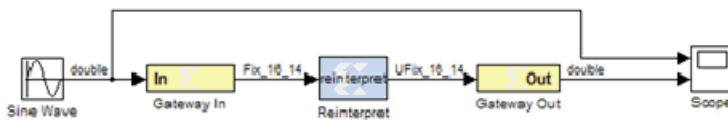

## The Convert Block

The Convert block changes the quantization of a number but not the value. This block can alter the number of bits used to represent a number. It can be used to convert a signed type to an unsigned type and visa versa. Often the Convert block is used to truncate the output fractional bits after a multiplication operation.

# Convert Block

- converts each input sample into a number of a desired arithmetic type
  - Converts a number to a signed (twos complement), unsigned value, or Boolean
  - The total number of bits and the binary point are user specified
  - Overflow and quantization options apply to the output value

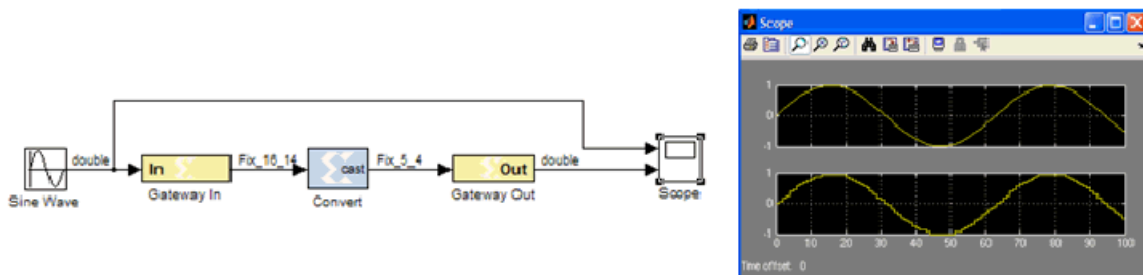

## The Concat Block

The Concat block concatenates two inputs into a single output at the bit level. This block has two input ports that are labeled *hi* and *lo*. The *hi* port occupies the MSB's and the *lo* input occupies the LSB's of the output signal. This block is useful for zero padding the MSBs or LSBs of a signal.

# Concat Block

- concatenates two inputs up to 16 bits
- All inputs must be unsigned integers
  - That is, unsigned numbers with binary points at position zero
- The Reinterpret block provides signed-to-unsigned conversion capabilities that can extend the functionality of the concat block

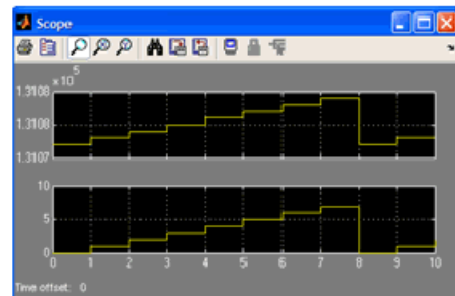
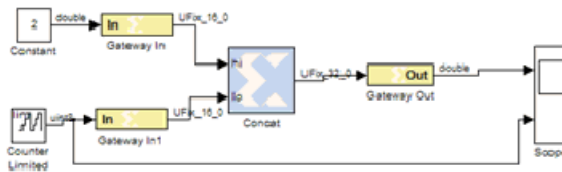

## Slice Block

The Slice block is used to access individual bits of a quantized number. This block provides several mechanisms by which the sequence of bits can be specified. If the input type is known at the time of parameterization, the various mechanisms do not offer any gain in functionality. If, however, a Slice block is used in a design where the input data width or binary point position are subject to change, the variety of mechanisms becomes useful. For example, the block can be configured to always extract only the top bit of the input, or only the integer bits, or only the first three fractional bits.

# Slice Block

- Slices off a sequence of bits from the input data to create a new data value
- The output data type is unsigned, with its binary point at zero
  - One bit slices can be set to type “boolean”

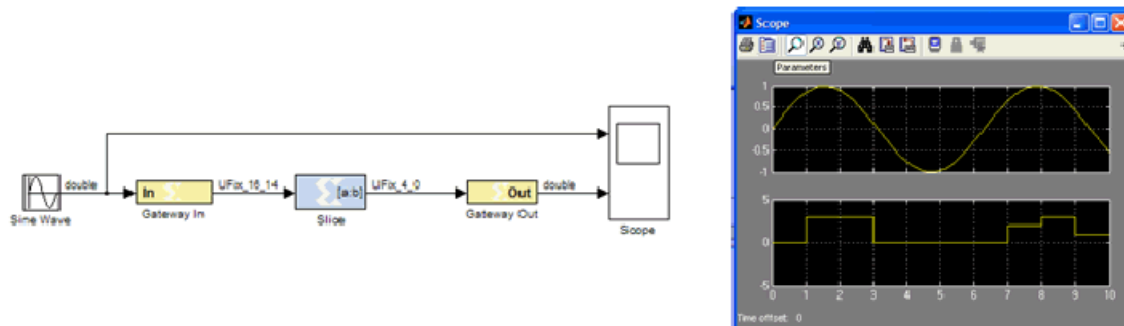



## The BitBasher Block

The BitBasher block provides a textual method, based on Verilog syntax, for working with the signals at the bit level. This block supports concatenation and slicing if the input signal to create an output. It also allows for augmentation with constants. The BitBasher block supports up to 4 outputs that are inferred by the expressions

# BitBasher Block

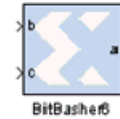

- Bit manipulation and augmentation through textual specification
  - Based on Verilog syntax
  - Supports Concatenation, Slicing and Repeat operators
  - Allows augmentation with constants specified as binary, decimal, octal or hex
  - At least one of the inputs must be from input port
  - Supports up to four outputs
    - Number of Output type and Binary point fields available in Output Type tab depends on number of output equations in Basic tab

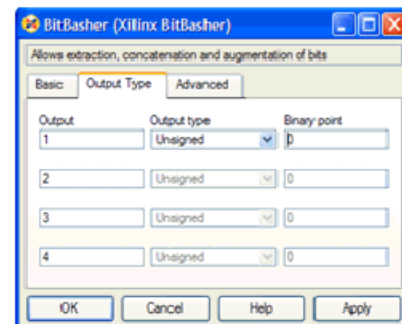
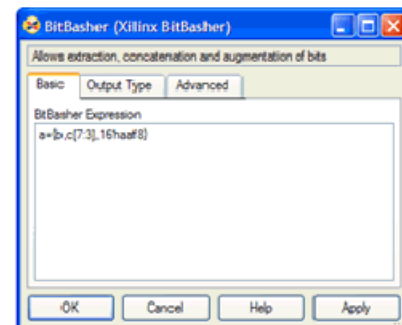

## Lesson 2 Summary

- Quantization and overflow options are available when the output of a block is user defined
- Quantization occurs when the number of fractional bits is insufficient to represent the fractional portion of a value
- Overflow occurs when a value lies outside the representable range
- Bit picking blocks allow combining of multiple buses into a single bus, force a conversion of data type without changing the number of bits, extract bits, and convert the number into different format
- The BitBasher block allows bit manipulation and augmentation through textual specification based in Verilog

## Lab Exercise: Signal Routing

In this lab you will design and verify padding and unpadding logic using the System Generator signal routing blocks

The lab instructions are located in the System Generator software tree at the following pathname:

```
<ISE_Design_Suite_tree>/sysgen/examples/getting_started_training/lab3/lab3.pdf
```

## Lesson 3 - System Control

### Controlling a DSP System

When you develop a DSP system in hardware, some level of control is usually required. This may include state dependent behavior or simply performing operations such as filter coefficient updating. System-level control may also be needed for controlling bursty data such as non-streaming FFTs.

# Controlling a DSP System

- Real hardware will require some level of operational System control
- System Generator supports the following control mechanisms
  - Finite State Machines
  - Bursty data flow control
  - Reset and Clock Enable pins
  - Logical expressions

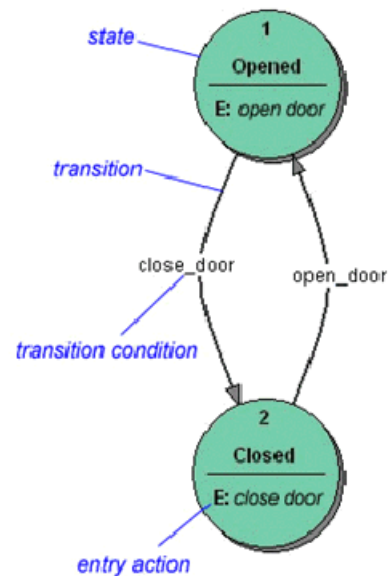

## The MCode Block

The MCode block supports the use of MATLAB for implementing state dependent and branch conditional control operations. This block is not suitable for MATLAB that describes an algorithmic operation such as a FIR filter or Matrix inverse. The MCode block provides a convenient and efficient method for implementing state machines and complex muxing conditions. This is the recommended way to implement a finite state machine in System Generator.

# The MCode Block

- System Generator includes an “MCode Block” that supports using MATLAB for modeling low-level hardware control structures
  - MATLAB is translated in VHDL during hardware generation
  - The MCode block does not support algorithmic MATLAB - use AccelDSP
- Recommended for implementing state machines in System Generator
  - A state variable is declared with the MATLAB keyword *persistent* and must be initially assigned with an *xl\_state* function call
- Restrictions
  - All block inputs and outputs must be Xilinx fixed-point type
  - The block must have at least one input port and one output port

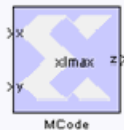

```
function q = accum(din, rst)
init = 0;
persistent s, s=xl_state(init, xLSigned,4,0);
q=s;
if rst
    s=init;
else
    s=s+din;
end
```

## The Xilinx “xl\_state” Data Type

When implementing a state machine using the MCode block, a Xilinx-provided MATLAB function called “xl\_state” must be used to initialize a persistent variable. This function has two arguments, the first is the initial condition, the second is the quantization of the assigned variable. For example, if your state machine has 6 states, you need a quantization of 4-bits unsigned.

### The Xilinx “xl\_state” Datatype

- “xl\_state” is a Xilinx provided MATLAB datatype that can be used with the MCode Block to specify FSM state variables
  - Vectors specified with “xl\_state” will be efficiently implemented hardware
  - `v = xl_state(init, precision)`
    - Init = initial value of state register after reset
    - Precision = a Xilinx fixed-point datatype defined for the MCode block:
      - `xlUnsigned(<word length>, <binary point>)`
      - `xlSigned(<word length>, <binary point>)`

## State Machine Example

The figure below shows a simple 2-state FSM. This can be easily extended to more states. Notice that a variable called “state” is declared to be persistent and is initialized to 2 bits, unsigned using the “xl\_state” function. A switch-case statement is then used to decode the inputs, branch to the next state and assign the outputs.

# State Machine Example

- The following simple FSM example shown how the MCode block can be used to implement a finite state machine
- This example can be easily extended to include more complex behavior

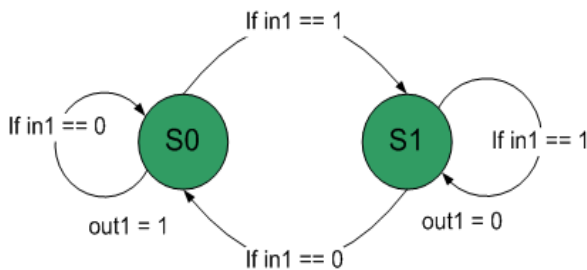

```
function [out1] = fsm(in1)

persistent state,
state=xl_state(0, {xlUnsigned,2,0});

switch double(state)
    case 0
        if in1==1;
            out1=0;
            state=1
        else
            out1=1;
            state=0;
        end
    case 1
        if in1==0
            out1=1;
            state=0;
        else
            out1=0;
            state=1;
        end
    otherwise
        state=0;
        out1=0;
end
```

## The Expression Block

The Expression block performs a bitwise not, and, or & xor on two input signals. The inputs can have a word length greater than 1. In cases where the two inputs have different word lengths, the binary points are matched up and then an element-by-element boolean operation is performed. This block provides a useful way to implement logical control in a DSP system

# The Expression Block

- The expression block provides an easy way to implement logical control using expressions
- Number of input ports is inferred from the expression
  - "a & b | c" = 3 inputs

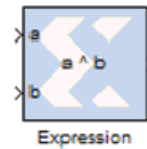

Operator	Symbol
Precedence	()
NOT	~
AND	&
OR	
XOR	^

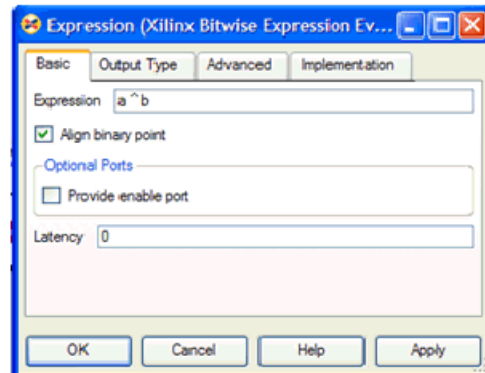

## Reset and Enable Ports

Most System Generator blocks that include memory or storage provide options to expose the reset and clock enable ports. If un-selected, these ports are automatically connected to the final hardware's global reset and clock enable or DCM schemes. Exposing these ports on the System Generator block creates a condition where the block is reset or enabled when either the global signals or the local signals assert TRUE. You should use these ports if greater control over these functions is required in the DSP system.

# Reset and Enable Ports

- System Generator blocks that include storage generally offer the option to add a reset and clock enable pin
  - The signals driving these ports must be of type "boolean"

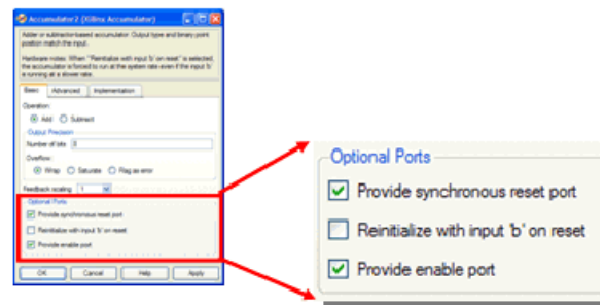



## Bursty Data

Several of the more complex DSP blocks offered in the Xilinx DSP blockset result in “bursty” data. For example, the non-streaming FFT requires several clock cycles to process the input data prior to generating valid output data. In these cases, these blocks include data flow control ports that must be used in the DSP system. These ports provide basic push mode dataflow control. They consist of a `vin` port which indicates that valid data is available at the inputs and `vout` which indicates that valid data is available at the outputs.

## Bursty Data

- Often the dataflow through the system is not continuous but rather comes in “bursts”
  - Non-streaming FFT
  - Resource shared FIR Filter
- In these cases the user will need to implement dataflow control into the System Generator diagram
- System Generator blocks that require extra data processing time will include two flow control ports called `vin` & `vout`



Blocks that have valid bit modeling:

- FIR (optional)
- FFT
- Reed-Solomon Encoder/Decoder
- Viterbi Decoder
- Convolutional Encoder
- Interleaver/DeInterleaver
- CIC

## Lesson 3 Summary

- Use the MCode block for state machines and branch conditional logic
- Use the Expression block to implement logical control at the bit level
- Storage elements have the ability to include optional reset and clock enable pins that can be connected in System Generator
- Blocks that operate on bursty data include data flow control pins called `vin` and `vout`

## Lab Exercise: System Control

In this lab you will be creating a simple state machine using the MCode block to detect a sequence of binary values "1011". The FSM needs to be able to detect multiple transmissions as well, i.e., "10111011"

The lab data and instructions are located in the System Generator software tree at the following pathname:

```
<ISE_Design_Suite_tree>/sysgen/examples/getting_started_training/lab4/
```

## Lesson 4 - Multi-Rate Systems

### Creating Multi-Rate Systems

The following illustration shows a typical base-station receiver. The tower has multiple antennas to provide sectored coverage of the area. The diagram shows that this results in two receiver channels. In each of these channels, there is some form of complex mixing, resulting in real and imaginary channels.

Often DSP systems such as this will down sample the input signals prior to the digital filtering steps performed during equalization and demodulation. Doing so can simplify the filter design and hardware significantly. These systems are referred to as “multi-rate” systems

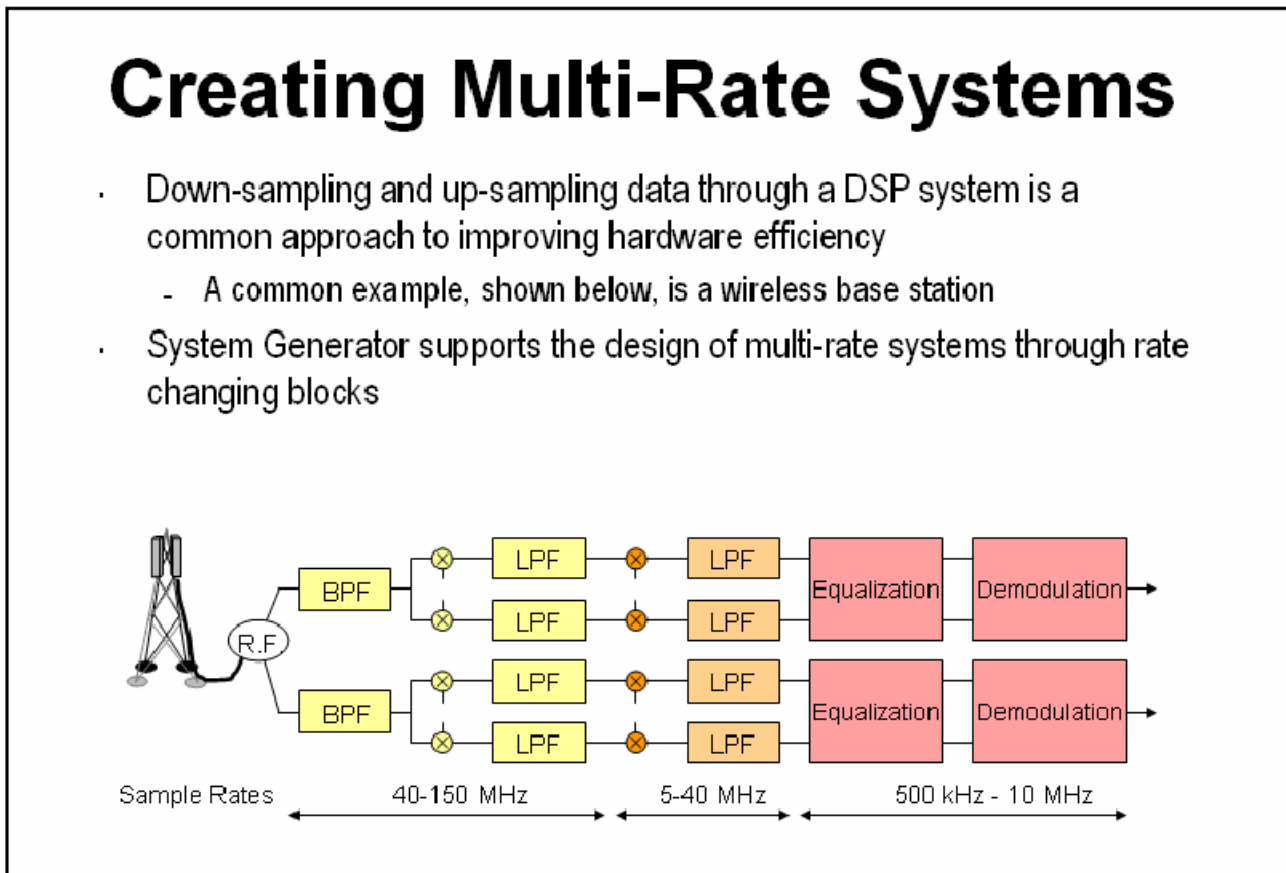

## Up and Down Sampling Blocks

System Generator includes Up Sample and Down Sample blocks that change the system sample rate. The Up Sample block adds additional samples to the signal to achieve the desired rate change. The value of these new samples is either zero or the value of the last actual sample depending on the block options. The Down Sample block simply discards samples until it achieves the desired rate change. For example, downsample by 3 means to discard 2 out of every 3 samples.

# Up and Down Sampling Blocks

- Use the “Up Sample” and “Down Sample” blocks to change the rate of a signal in System Generator

- The **up sample** can either replicate the same number  $M-1$  times or insert  $M-1$  zeros to achieve the higher sampling rate

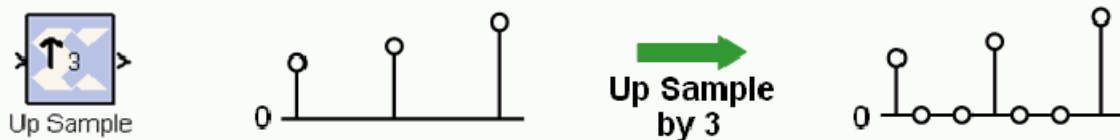

- The **down sample** “throws away”  $M-1$  samples to achieve the lower sampling rate

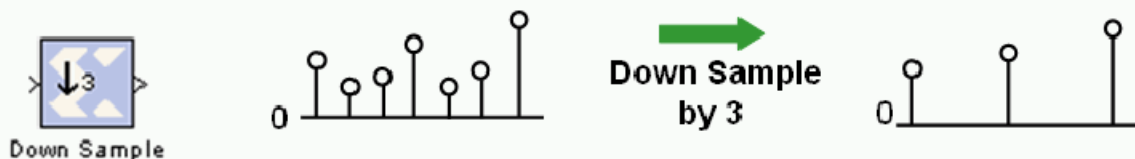



## Rate Changing Functional Blocks

In addition to the straightforward “Up Sample” and “Down Sample” blocks, System Generator also provides rate changing functional blocks; that is blocks that also perform a specific function. The Parallel to Serial block will up sample, the Serial to Parallel block will down sample, the FIR Compiler, if using a resource-shared multiplier will down sample and the TDM block will up sample.

# Rate Changing Functional Blocks

- The following functional blocks will also change the rate of a DSP system

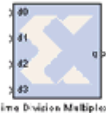
Parallel to Serial: The output rate will be M-times faster, where M is the width of the input parallel data	 Parallel to Serial
Serial to Parallel: The output rate will be M-times slower, where M is the width of the output parallel data	 Serial to Parallel
FIR and FIR Compiler: Can be used as a polyphase interpolation or decimation FIR	 FIR Compiler4C
The Time Division Multiplexer block multiplexes values presented at input ports into a single faster rate output. The up sample rate is determined by the number of input	 Time Division Multiplexer

## Viewing Rate Changes in Simulink

Simulink supports viewing different sample times as different colors which is fully supported for System Generator blocks. To enable the **Sample Time Colors** feature, select the pulldown menu **Format > Sample Time Colors**. The Simulink tool does not automatically recolor the model with each change you make to it, so you must select **Edit > Update Diagram** to explicitly update the model coloration. To return to your original coloring, disable the sample time coloration by, again, choosing **Sample Time Colors**.

# Viewing Rate Changes in Simulink

- Sample rates can be displayed in different colors using Simulink
  - Use the pull down menu command (**Format** → **Sample Time Colors**)
- The actual sample rate of a particular wire can be displayed using the “Sample Time” (ST) block in the Xilinx Blockset
  - Use the Simulink display block to view the output of the sample block
  - Does not add hardware to the design

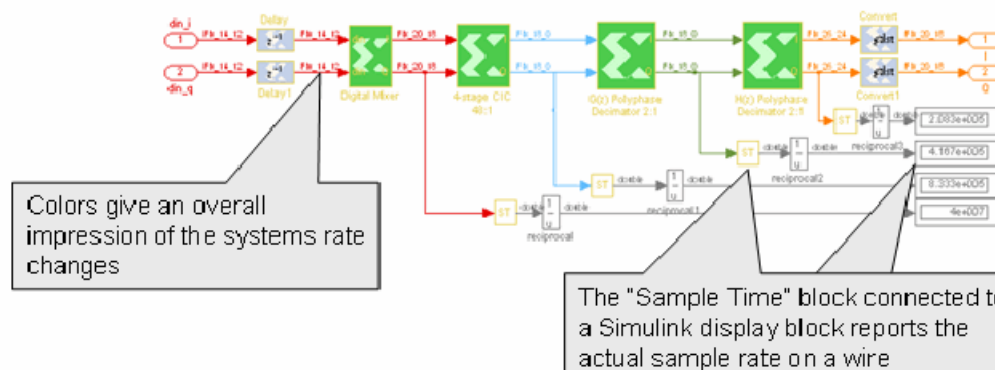

## Debugging Tools

System Generator provides 3 debugging utilities to assist in debugging complex multi-rate systems.

The Sample Time (ST) probe can be connected to any System Generator signal then to a Simulink “display” block from the “Sinks” library. The sample time for the connected net will appear in the display.

The `clk` probe is not connected to any inputs but only to a scope output. It displays the master clock. This can be used with the Clock Enable Probe to display the behavior of the clock enable signal at various points in the down sampling

# Debugging Tools

- The “clk” probe and the “clock enable probe” can be used to view the behavior of the multi-rate system
  - These blocks add no logic
  - Their outputs can be connected directly to a Simulink sink block

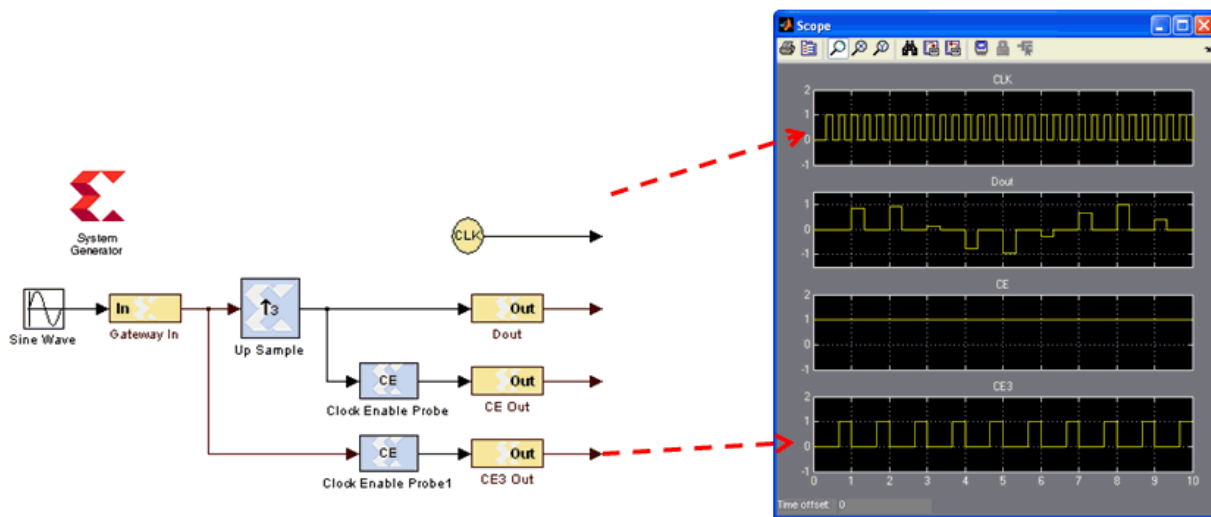

## Sample Period “Rules”

The illustration below is an example of a multi-rate system that demonstrates how the Simulink System Period can be calculated and entered into the System Generator token GUI.

If you get it wrong, there is a sampling period analyzer that automatically determines the appropriate sample period and prompts you to update the GUI.

## Sample Period “Rules”

- The system period is the global sample period from which all other sample periods can be derived
  - The System Period is set in the System Generator token
- Every sample period in a design must be a multiple of the system period

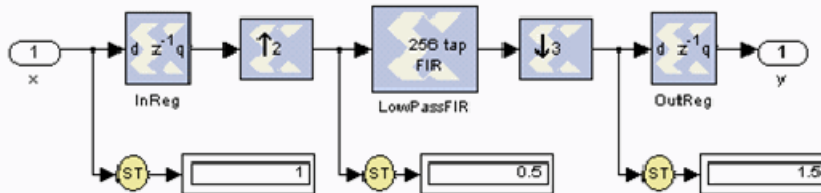

Block Output	X	Up Sample	Down Sample
Sample Period	1	.5	1.5
Sample Period (GCD)	$2/2$	$1/2$	$3/2$



## Lab Exercise: Multi-Rate Systems

In this lab you will be exploring the effects of the rate changing blocks available in System Generator. These blocks include Upsample, Downsample, Serial to Parallel and Parallel to Serial.

The lab instructions and lab design are located in the System Generator software tree at the following pathname:

```
<ISE_Design_Suite_tree>/sysgen/examples/getting_started_training/lab5/
```

## Lesson 5 - Using Memories

### Block vs. Distributed RAM

Xilinx FPGAs offer two distinct memory options, Block RAM and Distributed RAM. Block RAM uses dedicated, on-chip, hardware resources and represents the most area-efficient RAM implementation. Block RAMs offer high performance but due to their fixed location on the chip, may incur slightly larger routing delays. Distributed RAM uses the lookup tables in the FPGA slices to implement memory and in doing so will subtract from the slices available for logical operations. Because Distributed RAM can be located anywhere throughout the chip, routing delays can be minimized and slightly higher performance can be achieved. Distributed RAM is an excellent option for small FIFOs.

## Block vs. Distributed RAM

- Xilinx devices offer two implementation options for RAMs, FIFOs and ROMs
  - Block RAM – uses dedicated on-chip RAM resources
    - More area efficient
  - Distributed RAM – uses the FPGA lookup tables
    - Higher performance
    - Subtracts from available area for logic
- System Generator RAM, FIFO and ROM blocks support either implementation

Distributed RAM/SRL 16



- Very efficient, localized memory
- Minimal impact on logic routing
- Great for small FIFOs

On-chip BRAM/FIFO



- Efficient, on-chip blocks
- Flexible + optional FIFO logic
- Ideal for mid-sized FIFOs/buffers

## Initializing RAMs and ROMs

The RAM and ROM blocks can be initialized to a 1xn vector that matches the depth of the RAM. MATLAB is used to set the initial value vector. Any MATLAB statement can be used that results in a 1xn vector including the file reading commands such as `imread`, `auread`, `wavread`, and `load`.

# Initializing RAMs and ROMs

- MATLAB statements are used to initialize the RAMs and ROMs.
  - Statement must create a 1xn vector
- Loading a text file
  - `load('filename.txt')`
- Using a MATLAB statement
  - `sin(pi*(0:15)/16)`
- Reading other file formats
  - `imread`
  - `auread`
  - `wavread`
  - `uread`

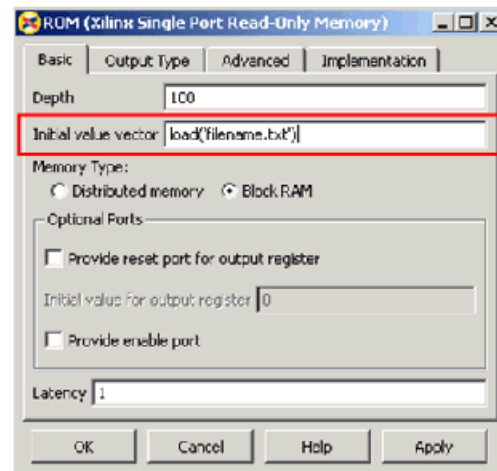

## System Generator RAM Blocks

System Generator provides both a single- and dual-port RAM block. Depths up to 64K are supported. Both Distributed RAM and Block RAM implementation options are available. System Generator calls the Xilinx memory compiler to create an efficient memory structure in hardware for the given parameters, bit widths and depths. You don't need to be concerned with the hardware details of the specific Virtex® block or Distributed RAM structure. Both the single- and dual-port RAM blocks support initialization. The signal connected to the address port of a RAM must be unsigned with no fractional bits.

## System Generator RAM Blocks

- System Generator offers both single and dual port RAM blocks

Options include selection of "Block" vs. "Distributed" implementation options

- These blocks call the Xilinx IP memory generator to create efficient RAM implementations for any depth and bit widths

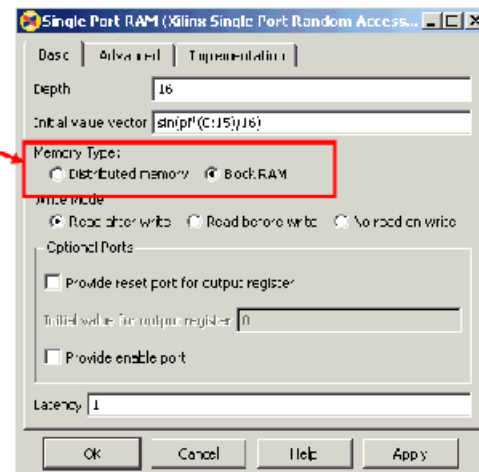
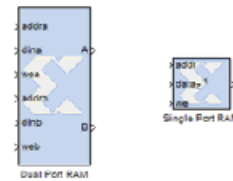

## System Generator ROM Blocks

The ROM block supports an implementation in either Block- or Distributed RAM and is initialized through a MATLAB command. The signal connected to the address port must be unsigned with no fractional bits

# System Generator ROM Blocks

- Offers both Block RAM vs. Distributed RAM implementation Options
- Address port must be unsigned with no fractional bits
- Depth and data widths are user configurable

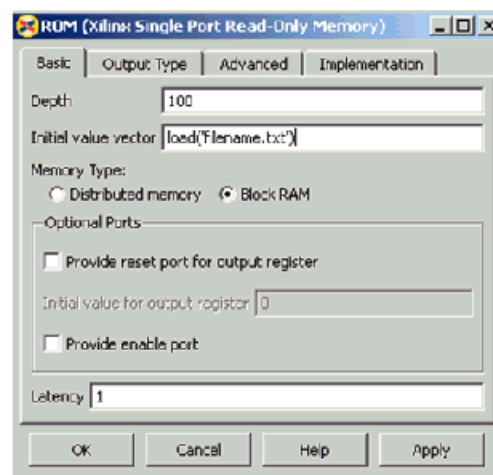

## The Delay Block

The Delay block is used to synchronize dataflow through the FPGA. This block maps to a highly-efficient shift register structure built from a slice lookup table called an SRL16 that is 85% smaller than using registers.

# The Delay Block

- Use the Delay block to synchronize the dataflow of signals through the design
- The implementation will be constructed from “SRL16E” primitives
  - Highly efficient use of the Virtex distributed RAM for implementing delay elements and shift registers



### SRL16E Structure

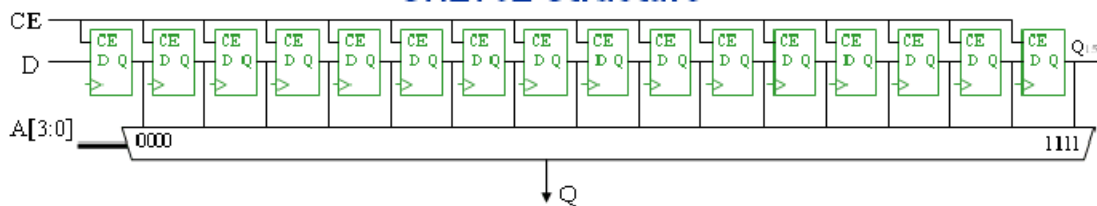

## The FIFO Block

The FIFO block supports both Block RAM and Distributed RAM implementations. Depths up to 64K are supported. Three output flags are supported, `empty`, `full` and `%full`. The `%full` flag is set depending on a bit width specification. One bit will be zero until the FIFO is 50% full, then it will set to 5. Two bits will be zero until 20% full, then .25, .5 and .75.

# FIFO Block

- Can be implemented in either Block or Distributed RAM
- Supports FIFO depths up to 64K
- Supports a “full” and “percentage full” output signals
  - %full Specified as number of bits
    - Unsigned, fractional
    - 1 bit shows <50% or >50% full
    - 2 bits show 25% full increments
- Includes optional control signals

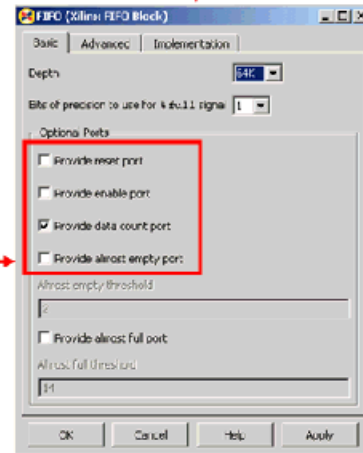
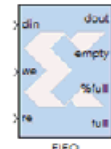

## Shared Memory Block

System Generator provides a simple abstraction for easily adding custom logic into a processor. The basic idea is to allow memories in custom logic to be easily mapped into the processor's memory address space. System Generator enables this through the use of Shared-Memory blocks provided in the System Generator block set.

# Shared Memory Block

- Shared memories (RAMs, FIFOs, registers) allows data to be accessed from the DSP or embedded portion of the design
- System Generator provides the necessary hardware interfaces and software drivers
- Can operate across different clock domains
- Can be compiled and co-simulated in FPGA hardware
- Generates memory-map interfaces between processor and user logic
- Supports both PLB and FSL bus types
- Provides API documentation

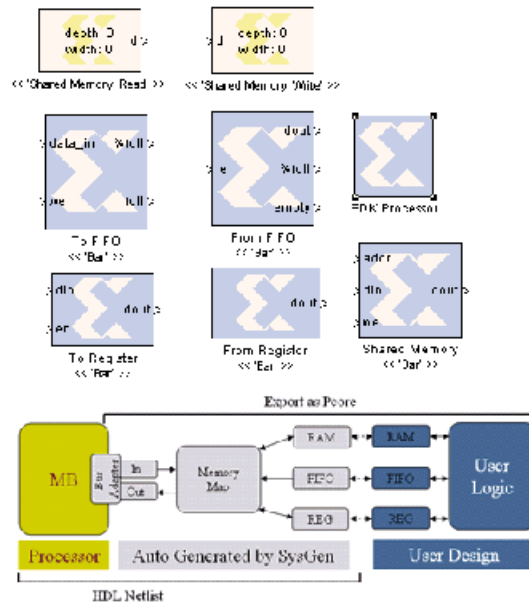



## Lab Exercise: Using Memories

In this lab you will learn how to use a Xilinx ROM block to implement a LUT-based operation such as an Arcsin using Block RAM or Distributed RAM. This provides an efficient implementation for trig and math functions with inputs that can be quantized to 10 bits or less.

The lab instructions and lab design are located in the System Generator software tree at the following pathname:

```
<ISE_Design_Suite_tree>/sysgen/examples/getting_started_training/lab6/
```

## Lesson 6 - Designing Filters

### Introduction

Digital filters are a common DSP operation and especially well suited to implementation in FPGAs. High-performance applications benefit greatly from parallel filters that can return a results on every clock cycle. The Virtex®- 5 device includes up to 550 parallel multipliers. The FIR Compiler is designed to use these multipliers in the most efficient manner for creating commonly used FIR filters. An alternative implementation is available called “distributed arithmetic” that creates FIR filters without using multipliers by employing a shift-add technique. This can be used for smaller devices when the available multipliers have been allocated to other functions.

## Introduction

- Digital filters are the most common functions found in DSP systems
- The following blocks are supported by System Generator for digital filtering
  - FIR Compiler block (DSP Blockset)
  - DAFIR block (DSP Blockset)
  - CIC block (Reference Designs Blockset)
- The digital filtering technique will depend on several factors
  - Sample rate
  - Sample width
  - Profile of the coefficients
  - Clock rate
  - Technological resources

## The Virtex DSP48 Math Slice

The Virtex® family introduces a high-performance arithmetic unit along with a multiplier: the low-power DSP48 slice. The following figure is a detailed diagram of the DSP48 structure. The DSP48 slice consists of four main sections: (1) I/O registers, (2) signed multiplier, (3) three-input adder/subtractor, and (4) OPMODE multiplexers.

# The Virtex DSP48 Math Slice

- The Virtex4 & 5 devices include up to 550 DSP48 slices
  - Performs 48 unique math operations common to DSP operations
  - Configuration set through an “opcode” input
- Efficient use of DSP48 slice is required to get high performance and efficient filters

*Virtex4 DSP48 Math Slice*

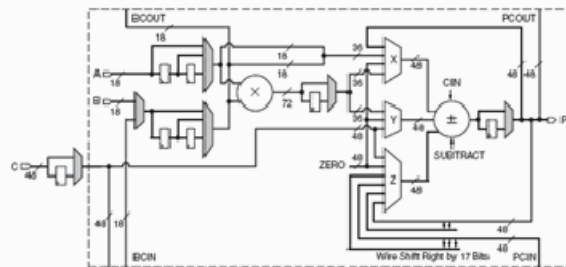

*Virtex5 DSP48 Math Slice*

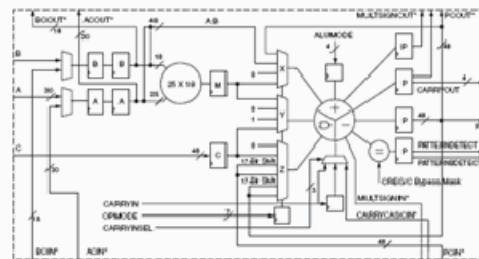

## FIR Compiler Block

The Xilinx Fir Compiler block implements a high speed MAC based FIR filter. It accepts a stream of input data and computes filtered output with a fixed delay, based on the filter configuration. The FIR Compiler supports generation of resource shared or parallel FIR structures and polyphase decimation and interpolation structures. Also supported is oversampling. Coefficients are specified using MATLAB commands.

# FIR Compiler Block

- The Xilinx FIR Compiler block implements a high speed MAC based using DSP48/DSP48E/DSP48A primitives or Distributed Arithmetic FIR filters
- Supports polyphase decimation, polyphase interpolation and over sampling implementations

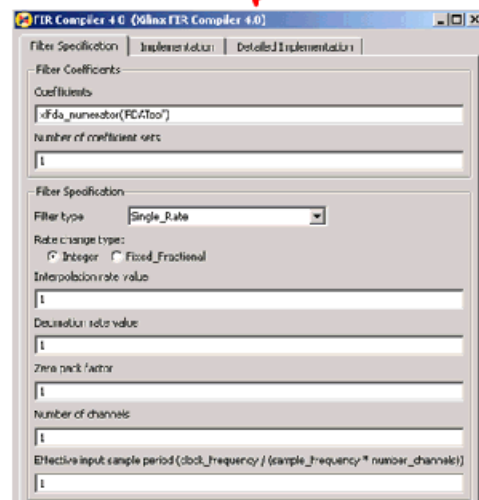
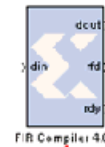

## Creating Coefficients with FDATool

The MathWorks FDATool is a graphical filter design program that can be used to generate coefficients for the FIR Compiler block. The Xilinx FDATool block provides an interface to the FDATool software available as part of the MATLAB Signal Processing Toolbox. In order for this block to function properly, the Signal Processing Toolbox must be installed.

# Creating Coefficients with FDATool

- Provides an interface to the FDATool software
- Enables the use of The Mathworks FDATool for creating filter coefficients graphically
- Provides a powerful means for defining digital filters with GUI
- Coefficients can be “exported” to either the MATLAB workspace or a text file

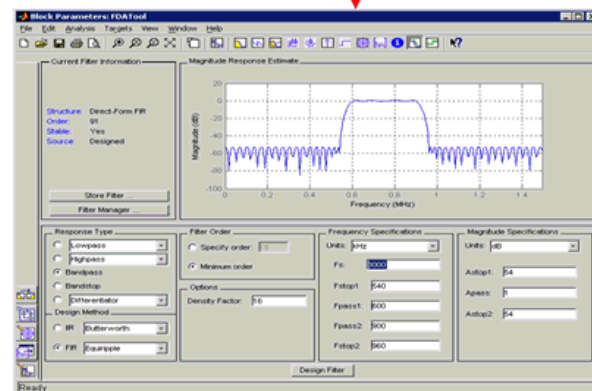
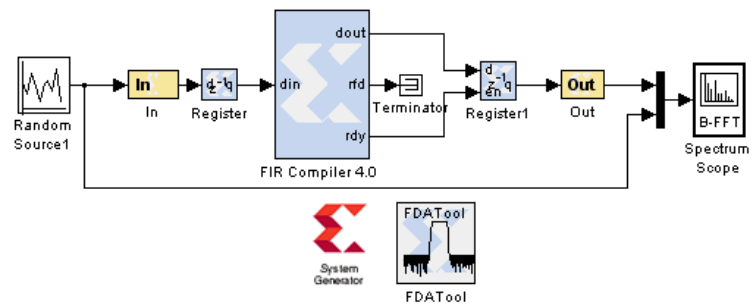

## Using FDA Tool Coefficients

Once a suitable filter response has been designed, you simply export the coefficients to the workspace using the **File > Export** command. The workspace variable can then be referenced in the FIR Compiler properties editor

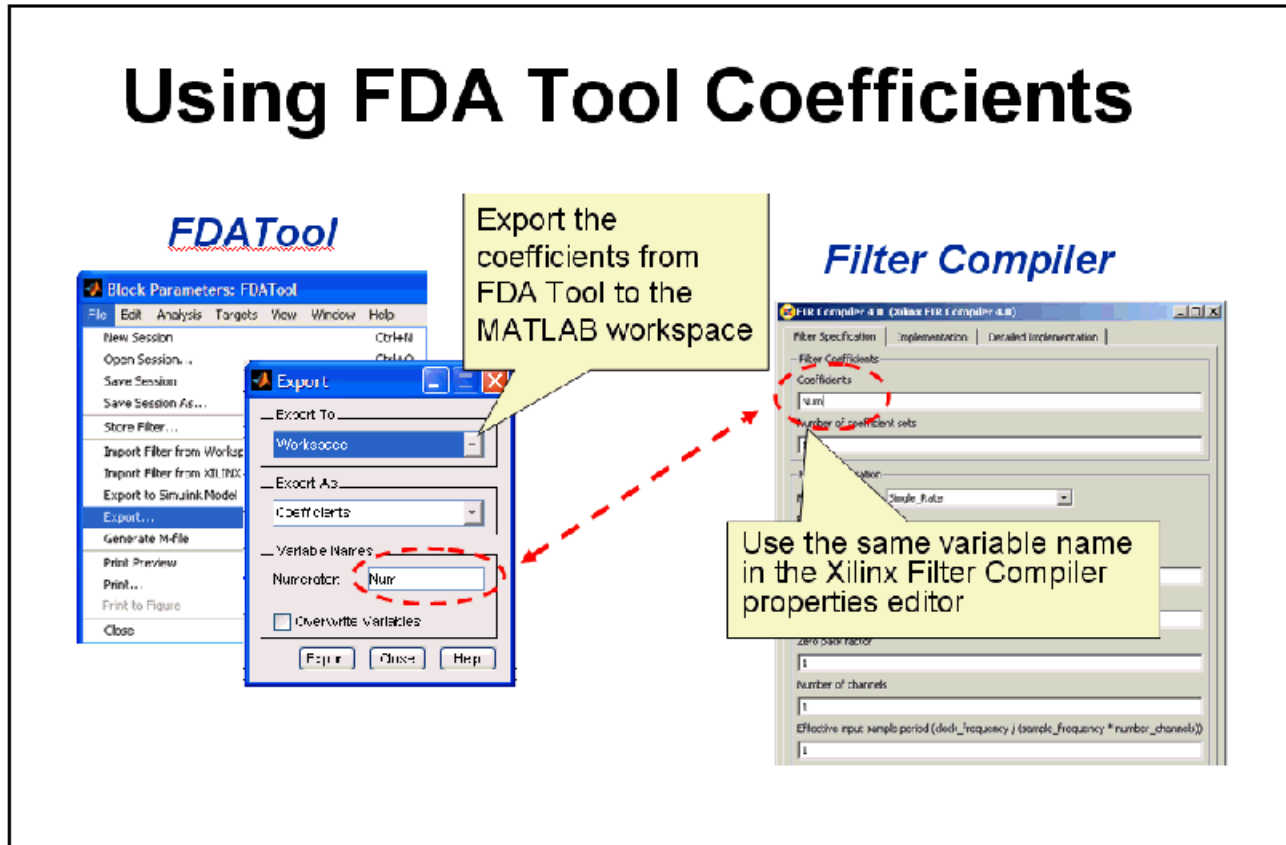

## Lab Exercise: Designing Filters

In this lab you will be using the Filter Compiler block to generate optimized filters for the Virtex®-5 architecture.

The lab instructions and lab design are located in the System Generator software tree at the following pathname:

```
<ISE_Design_Suite_tree>/sysgen/examples/getting_started_training/lab7/
```

## Additional Examples and Tutorials

Numerous examples are used to illustrate System Generator features and functions in the System Generator documentaton. These examples are found in the directory at pathname <ISE\_Design\_Suite\_tree>/sysgen/examples and are listed in the table below. In addition to these examples, System Generator also includes demonstration models that can be run from the demo page. Enter the following command at the MATLAB prompt:

```
demo blocksets xilinx
```

**Note:** If you are using the MATLAB help browser you can open and run the examples directly from this page. To run an example, click on the link. MATLAB will change directories to the example directory and open the example model.

### AXI4 Conversion Examples

Topic	Description
<a href="#">How to Migrate from DDS Compiler 4.0 to DDS Compiler 5.0</a>	Design example showing how to migrate a non-AXI4 DDS Compiler 4.0 block to an AXI4 DDS Compiler 5.0 block.
<a href="#">How to Migrate from Fast Fourier Transform 7.1 to Fast Fourier Transform 8.0</a>	Design example showing how to migrate a non-AXI4 Fast Fourier Transform 7.1 block to an AXI4 Fast Fourier Transform 8.0 block.

### Black Box Examples

Topic	Description
<a href="#">Importing a VHDL Module</a>	A tutorial showing how to use the black box to import VHDL into a System Generator design and how to use ModelSim to co-simulate the VHDL module.
<a href="#">Simulating Several Black Boxes Simultaneously</a>	Shows how black boxes can co-simulate simultaneously, using only one ModelSim license.
<a href="#">Dynamic Black Boxes</a>	A tutorial showing how to parameterize the black box.
<a href="#">Importing a Verilog Module</a>	A tutorial showing how to use the black box to import Verilog into a System Generator design and how to use ModelSim to co-simulate the Verilog module.
<a href="#">Importing a Xilinx Core Generator Module</a>	A tutorial showing how to import a COREGEN module as a black box.



## ChipScope Examples

Topic	Description
<a href="#">Using ChipScope Pro Analyzer for Real-Time Hardware Debugging</a>	This tutorial demonstrates how to connect and use the Xilinx Debug Tool called ChipScope™ Pro within Xilinx System Generator for DSP. The integration of ChipScope Pro in the System Generator flow allows real-time debugging at system speed.

## DSP Examples

Topic	Description
<a href="#">DSP48 Block</a>	Simple example demonstrating the use of the DSP48 block with the Constant block used to provide the DSP48 instruction.
<a href="#">DSP48 Macro Block</a>	Simple example demonstrating how to use a DSP48 Macro block to implement a Complex Multiplier.
<a href="#">DSP48 Block (35-Bit Multiplier using DSP48 and Constant block)</a>	This design demonstrates the use of the DSP48 and Constant block in implementing 35 by 35-bit multipliers at different sample rates. Three multipliers implementations are shown at 1, 2, and 4 clocks per sample.
<a href="#">DSP48 Macro Block (FIR filter using the DSP48 Macro block as a multiply accumulate function)</a>	This design demonstrates the use of the DSP48 Macro block in implementing a 35 by 35 Multiplier.
<a href="#">DSP48 Block FIR filter examples using DSP48 block</a>	This design demonstrates the use of the DSP48 and Constant block in FIR filter implementation. The design includes sets of parallel, semi-parallel and sequential FIR filter using Type 1 and Type 2 architectures. Each filter implements a 16-tap dsp48-based FIR filters.
<a href="#">DSP48 Design Techniques (DSP48-based dynamic shifter)</a>	This design demonstrates the use of the DSP48 block in implementing a 35-bit signed right shift using 2 DSP48s.
<a href="#">DSP48 Design Techniques (Synthesizable FIR filter for Virtex®-4)</a>	This design demonstrates how to use System Generator to implement a synthesizable FIR filter which maps efficiently to the Virtex®-4 architecture.
<a href="#">DSP48 Macro Block (FIR filter using the DSP48 Macro block as a multiply accumulate function)</a>	This design demonstrates the use of the DSP48 Macro block when implementing a sequential FIR filter.

Topic	Description
MAC FIR filter	This design example implements a 43 tap FIR Filter with a MAC engine and a Dual Port Ram used for data and coefficient storage.
Complex FIR filter	This example demonstrates a complex FIR filter built out of blocks from the System Generator and Simulink library.

## M-Code Examples

Topic	Description
Simple Selector	This example shows how to implement a function that returns the maximum value of its inputs.
Simple Arithmetic Operations	This example shows how to implement simple arithmetic operations.
Complex Multiplier with Latency	This example shows how to build a complex multiplier with latency.
Shift Operations	This example shows how to implement shift operations.
Passing Parameters into the MCode Block	This example shows how to pass parameters into a MCode block.
Optional Input Ports	This example shows how to implement optional input ports on an MCode block.
Finite State Machines	This example shows how to implement a finite state machine.
Parameterizable Accumulator	This example shows how to build a parameterizable accumulator.
FIR Blocks and Verification	This example shows how to model FIR blocks and how to do system verification.
RPN Calculator	This example shows how to model a RPN calculator – a stack machine.
Example of disp function	This example shows how to use the disp function.

## Processor Examples

Topic	Description
<a href="#">Tutorial Example - Designing and Simulating MicroBlaze Processor Systems</a>	Demonstrates how to import a MicroBlaze processor created using Xilinx Platform Studio into System Generator. A DSP48 block is used as a co-processor to the MicroBlaze processor.
<a href="#">Designing PicoBlaze Microcontroller Applications</a>	Demonstrates how to implement a PicoBlaze™ program in System Generator. The example programs the PicoBlaze to alter the output frequency of a Direct Digital Synthesizer (DDS) during an interrupt.

## Shared Memory Examples

Topic	Description
Simulation across various models	Illustrates shared memories communicating across Simulink models.
Host PC Shared Memory access	Developer studio project to communicate with a shared memory.
High Speed Video Processing using Hardware Co-simulation	Discussion of a high-speed co-simulation buffering interface followed by an example in which the interface is used to support real-time processing of a video stream using a 5x5 filter kernel.
High speed I/O Buffering	Illustrates high speed Shared Memory I/O Buffering Interface for Hardware Co-simulation.
<a href="#">Generating Multiple Cycle-True Islands for Distinct Clocks</a>	An example using two asynchronous clocks.
Shared Memory, To FIFO, To Register, To Register, From Register	Demonstrates use of shared memories, FIFOs and registers to pass information.
<a href="#">Frame-Based Acceleration using Hardware Co-Simulation</a>	Explains how to use frame or vector-based transfers to further accelerate simulations using FPGA hardware co-simulation.
<a href="#">Tutorial Example - Using System Generator and SDK to Co-Debug an Embedded DSP Design</a>	Integrating a processor with custom logic such as those from DSP designs is a fairly involved process. In this tutorial example, you will learn how to perform hardware and software co-debugging using System Generator and the Xilinx Software Development Kit (SDK) together.

## Miscellaneous Examples

Topic	Description
<a href="#">Importing a System Generator Design into a Bigger System</a>	Discusses how to take the VHDL netlist from a System Generator design and synthesize it in order to embed it into a larger design. Also shows how VHDL created by System Generator can be incorporated into simulation model of the overall system.
<a href="#">Configurable Subsystems and System Generator</a>	Illustrates the use of Configurable Subsystems for Simulation and Generation.
Integrator	This example uses an integrator to illustrate error analysis capability.
Block RAM-Based State Machines	Demonstrates use of Mealy State Machine block from the reference library.

## System Generator Demos

System Generator for DSP provides the capability to model and implement high-performance DSP systems in field-programmable gate arrays (FPGAs) using Simulink. The Xilinx Blockset contains bit and cycle-true models of arithmetic and logic functions, memories, and DSP functions for digital filtering, spectral analysis, and digital communications. System Generator converts a Simulink model of Xilinx blocks into an efficient hardware implementation that combines synthesizable VHDL and intellectual property blocks that have been hand-crafted to run efficiently in FPGAs.

Included with the tool are numerous demonstration designs that highlight key features and tool capabilities, as well as general good design practices using real-world design applications. These designs may be accessed from the System Generator demo page. Enter the following command at the MATLAB prompt:

```
demo blocksets xilinx
```



# Index

---

## B

Block Color  
    meaning of block background color  
    25

## C

Color  
    meaning of block background color  
    25

Compiling  
    Xilinx HDL Libraries 19

Configuring  
    the Sysgen cache 19

## D

Downloading  
    System Generator 15

## H

Hardware Co-Sim  
    installation 18

## I

Installation  
    Hardware Co-Sim 18  
    software prerequisites 16  
ISE Design Suite Installer 16

## S

System Generator  
    Cache 19  
    changing versions 20  
    displaying versions 20  
    downloading the software 15  
    ISE Design Suite Installer 16

## X

Xilinx HDL Libraries  
    compiling 19