

# System Generator for DSP

## *Reference Guide*

UG638 (v14.5) March 20, 2013

This document applies to the following software versions: ISE Design Suite 14.5 through 14.7





Xilinx is disclosing this user guide, manual, release note, and/or specification (the "Documentation") to you solely for use in the development of designs to operate with Xilinx hardware devices. You may not reproduce, distribute, republish, download, display, post, or transmit the Documentation in any form or by any means including, but not limited to, electronic, mechanical, photocopying, recording, or otherwise, without the prior written consent of Xilinx. Xilinx expressly disclaims any liability arising out of your use of the Documentation. Xilinx reserves the right, at its sole discretion, to change the Documentation without notice at any time. Xilinx assumes no obligation to correct any errors contained in the Documentation, or to advise you of any corrections or updates. Xilinx expressly disclaims any liability in connection with technical support or assistance that may be provided to you in connection with the Information.

THE DOCUMENTATION IS DISCLOSED TO YOU "AS-IS" WITH NO WARRANTY OF ANY KIND. XILINX MAKES NO OTHER WARRANTIES, WHETHER EXPRESS, IMPLIED, OR STATUTORY, REGARDING THE DOCUMENTATION, INCLUDING ANY WARRANTIES OF MERCHANTABILITY, FITNESS FOR A PARTICULAR PURPOSE, OR NONINFRINGEMENT OF THIRD-PARTY RIGHTS. IN NO EVENT WILL XILINX BE LIABLE FOR ANY CONSEQUENTIAL, INDIRECT, EXEMPLARY, SPECIAL, OR INCIDENTAL DAMAGES, INCLUDING ANY LOSS OF DATA OR LOST PROFITS, ARISING FROM YOUR USE OF THE DOCUMENTATION.

© Copyright 2006 - 2013. Xilinx, Inc. XILINX, the Xilinx logo, Artix, ISE, Kintex, Spartan, Virtex, and other designated brands included herein are trademarks of Xilinx in the United States and other countries. All other trademarks are the property of their respective owners.

---

# Table of Contents

---

## Chapter 1: Xilinx Blockset

<b>Organization of Blockset Libraries</b> .....	20
AXI4 Blocks .....	21
Basic Element Blocks .....	22
Communication Blocks .....	24
Control Logic Blocks .....	25
Data Type Blocks .....	27
DSP Blocks .....	28
Floating-Point Blocks .....	30
Index Blocks .....	32
Math Blocks .....	41
Memory Blocks .....	43
Shared Memory Blocks .....	44
Tool Blocks .....	44
Simulink Blocks Supported by System Generator .....	46
<b>Common Options in Block Parameter Dialog Boxes</b> .....	47
Avoid Naming Your Design the Same as a Xilinx Block .....	47
Precision .....	47
Arithmetic Type .....	47
Number of Bits .....	47
Binary Point .....	47
Overflow and Quantization .....	47
Latency .....	48
Provide Synchronous Reset Port .....	48
Provide Enable Port .....	48
Sample Period .....	49
Use Behavioral HDL (otherwise use core) .....	49
Use XtremeDSP Slice .....	49
FPGA Area (Slices, FFs, LUTs, IOBs, Embedded Mults, TBUFs) / Use Area Above For Estimation	49
Display shortened port names .....	50
<b>Block Reference Pages</b> .....	51
<b>Absolute</b> .....	52
Block Parameters .....	52
LogiCORE™ Documentation .....	52
Device Support .....	53
<b>Accumulator</b> .....	54
Block Interface .....	54
Block Parameters .....	54
LogiCORE™ Documentation .....	55
Device Support .....	55
<b>Addressable Shift Register</b> .....	56
Block Interface .....	56
Block Parameters .....	57
LogiCORE™ Documentation .....	57
Device Support .....	57
<b>AddSub</b> .....	58

Block Parameters .....	58
LogiCORE™ Documentation .....	59
Device Support .....	59
<b>Assert</b> .....	60
Block Parameters .....	60
Using the Assert block to Resolve Rates and Types .....	61
LogiCORE™ Documentation .....	61
Device Support .....	62
<b>AXI FIFO</b> .....	63
Block Interface .....	63
Block Parameters .....	63
LogiCORE™ Documentation .....	65
Device Support .....	65
<b>BitBasher</b> .....	66
Block Parameters .....	66
Supported Verilog Constructs .....	66
Limitations .....	68
<b>Black Box</b> .....	69
Requirements on HDL for Black Boxes .....	69
The Black Box Configuration Wizard .....	70
The Black Box Configuration M-Function .....	71
Sample Periods .....	72
Block Parameters .....	73
Data Type Translation for HDL Co-Simulation .....	74
An Example .....	75
Device Support .....	76
See Also .....	76
<b>ChipScope</b> .....	77
Hardware and Software Requirements .....	77
Block Parameters .....	77
ChipScope Project File .....	78
Importing Data Into MATLAB Workspace From ChipScope .....	78
Known Issues .....	79
More Information .....	79
<b>CIC Compiler 2.0</b> .....	80
Block Parameters Dialog Box .....	80
LogiCORE™ Documentation .....	81
Device Support .....	81
<b>CIC Compiler 3.0</b> .....	82
Sample Rates and the CIC Compiler Block .....	82
Block Parameters Dialog Box .....	82
LogiCORE™ Documentation .....	84
Device Support .....	84
<b>Clock Enable Probe</b> .....	85
Options .....	86
<b>Clock Probe</b> .....	87
<b>CMult</b> .....	88
Block Parameters .....	88
LogiCORE™ Documentation .....	89
Device Support .....	89
<b>Complex Multiplier 3.1</b> .....	90

Block Parameters Dialog Box . . . . .	90
LogiCORE™ Documentation . . . . .	91
Device Support . . . . .	91
<b>Complex Multiplier 5.0</b> . . . . .	92
Block Parameters Dialog Box . . . . .	92
LogiCORE™ Documentation . . . . .	96
Device Support . . . . .	96
<b>Concat</b> . . . . .	97
Block Interface . . . . .	97
Block Parameters . . . . .	97
<b>Configurable Subsystem Manager</b> . . . . .	98
Block Parameters . . . . .	99
<b>Constant</b> . . . . .	100
Block Parameters . . . . .	100
Appendix: DSP48 Control Instruction Format . . . . .	102
<b>Convert</b> . . . . .	103
Block Parameters . . . . .	103
LogiCORE™ Documentation . . . . .	104
Device Support . . . . .	104
<b>Convolution Encoder 7.0</b> . . . . .	105
Block Parameters Dialog Box . . . . .	105
LogiCORE™ Documentation . . . . .	106
Device Support . . . . .	106
<b>Convolution Encoder 8.0</b> . . . . .	107
Block Parameters Dialog Box . . . . .	107
LogiCORE™ Documentation . . . . .	108
Device Support . . . . .	108
<b>CORDIC 4.0</b> . . . . .	109
Block Parameters Dialog Box . . . . .	109
LogiCORE™ Documentation . . . . .	111
Device Support . . . . .	111
<b>CORDIC 5.0</b> . . . . .	112
Changes from CORDIC 4.0 to CORDIC 5.0 . . . . .	112
Block Parameters Dialog Box . . . . .	113
LogiCORE™ Documentation . . . . .	116
Device Support . . . . .	116
<b>Counter</b> . . . . .	117
Block Parameters . . . . .	118
LogiCORE™ Documentation . . . . .	118
Device Support . . . . .	118
<b>DDS Compiler 4.0</b> . . . . .	119
Architecture Overview . . . . .	119
Block Interface . . . . .	120
Block Parameters . . . . .	121
LogiCORE™ Documentation . . . . .	123
Device Support . . . . .	123
<b>DDS Compiler 5.0</b> . . . . .	124
Architecture Overview . . . . .	124
AXI Ports that are Unique to this Block . . . . .	125
Block Parameters . . . . .	125
LogiCORE™ Documentation . . . . .	130

Device Support . . . . .	130
<b>Delay</b> . . . . .	131
Block Parameters . . . . .	131
Logic Synthesis using Behavioral HDL . . . . .	132
Logic Synthesis using Structural HDL . . . . .	132
Implementing Long Delays . . . . .	135
Re-settable Delays and Initial Values . . . . .	135
Device Support . . . . .	136
<b>Depuncture</b> . . . . .	137
Block Parameters . . . . .	138
<b>Disregard Subsystem</b> . . . . .	139
<b>Divide</b> . . . . .	140
LogiCORE™ Documentation . . . . .	141
Device Support . . . . .	141
<b>Divider Generator 3.0</b> . . . . .	142
Block Parameters . . . . .	142
LogiCORE™ Documentation . . . . .	143
Device Support . . . . .	143
<b>Divider Generator 4.0</b> . . . . .	144
Block Parameters . . . . .	144
LogiCORE™ Documentation . . . . .	146
Device Support . . . . .	146
<b>Down Sample</b> . . . . .	147
Zero Latency Down Sample . . . . .	147
Down Sample with Latency . . . . .	148
Block Parameters . . . . .	149
Xilinx LogiCORE . . . . .	149
<b>DSP48</b> . . . . .	150
Block Parameters . . . . .	150
See Also . . . . .	152
<b>DSP48 Macro</b> . . . . .	153
Block Interface . . . . .	153
Block Parameters . . . . .	153
Entering Opmodes in the DSP48 Macro Block . . . . .	154
Entering Pipeline Options and Editing Custom Pipeline Options . . . . .	160
DSP48 Macro Limitations . . . . .	161
See Also . . . . .	161
<b>DSP48 macro 2.0</b> . . . . .	162
Block Parameters . . . . .	162
LogiCORE™ Documentation . . . . .	166
Device Support . . . . .	166
See Also . . . . .	166
<b>DSP48 Macro 2.1</b> . . . . .	167
Block Parameters . . . . .	167
LogiCORE™ Documentation . . . . .	171
zDevice Support . . . . .	171
See Also . . . . .	171
<b>DSP48A</b> . . . . .	172
Block Parameters . . . . .	172
See Also . . . . .	174

<b>DSP48E</b> .....	175
Block Parameters .....	175
See Also .....	179
<b>DSP48E1</b> .....	180
Block Parameters .....	180
See Also .....	184
<b>Dual Port RAM</b> .....	185
Block Interface .....	185
Block Parameters .....	187
Xilinx LogiCORE .....	189
LogiCORE™ Documentation .....	189
Device Support .....	189
<b>EDK Processor</b> .....	191
Memory Map Interface .....	191
Block Parameters .....	192
Known Issues .....	194
Online Documentation for the MicroBlaze Processor .....	194
<b>Expression</b> .....	195
Block Parameters .....	195
<b>Fast Fourier Transform 7.1</b> .....	196
Theory of Operation .....	196
Block Interface .....	196
Block Parameters .....	198
Block Timing .....	200
LogiCORE™ Documentation .....	200
Device Support .....	200
<b>Fast Fourier Transform 8.0</b> .....	202
Theory of Operation .....	202
AXI Ports that are Unique to this Block .....	202
Block Parameters .....	203
Block Timing .....	205
LogiCORE™ Documentation .....	207
Device Support .....	208
<b>FDA Tool</b> .....	209
Example of Use .....	209
FDA Tool Interface .....	209
<b>FIFO</b> .....	210
Block Parameters .....	210
LogiCORE™ Documentation .....	211
Device Support .....	211
<b>FIR Compiler 5.0</b> .....	212
Block Interface .....	212
Block Parameters .....	213
LogiCORE™ Documentation .....	218
Device Support .....	218
<b>FIR Compiler 6.2</b> .....	219
AXI Ports that are Unique to this Block .....	219
Block Parameters .....	219
LogiCORE™ Documentation .....	227
Device Support .....	227
<b>FIR Compiler 6.3</b> .....	228

AXI Ports that are Unique to this Block . . . . .	228
Block Parameters . . . . .	228
Channel Specification tab . . . . .	229
LogiCORE™ Documentation . . . . .	236
Device Support . . . . .	236
<b>From FIFO . . . . .</b>	<b>237</b>
Block Parameters . . . . .	237
LogiCORE™ Documentation . . . . .	239
Device Support . . . . .	239
See Also . . . . .	239
<b>From Register . . . . .</b>	<b>240</b>
Block Parameters . . . . .	240
Crossing Clock Domain . . . . .	241
See Also . . . . .	241
<b>Gateway In . . . . .</b>	<b>242</b>
Gateway Blocks . . . . .	242
Block Parameters . . . . .	242
<b>Gateway Out . . . . .</b>	<b>244</b>
Gateway Blocks . . . . .	244
Block Parameters . . . . .	244
<b>Indeterminate Probe . . . . .</b>	<b>246</b>
<b>Interleaver/De-interleaver 6.0 . . . . .</b>	<b>247</b>
Forney Convolutional Operation . . . . .	247
Rectangular Block Operation . . . . .	248
Block Parameters . . . . .	249
How to Migrate an Interleaver De-Interleaver 5.1 block to 6.0 . . . . .	254
LogiCORE™ Documentation . . . . .	256
Device Support . . . . .	257
<b>Interleaver/De-interleaver 7.0 . . . . .</b>	<b>258</b>
Forney Convolutional Operation . . . . .	258
Configuration Swapping . . . . .	260
Rectangular Block Operation . . . . .	260
AXI Interface . . . . .	261
AXI Ports that are Unique to this Block . . . . .	261
Block Parameters . . . . .	263
LogiCORE™ Documentation . . . . .	266
Device Support . . . . .	266
<b>Interleaver/De-interleaver 7.1 . . . . .</b>	<b>267</b>
Forney Convolutional Operation . . . . .	267
Configuration Swapping . . . . .	269
Rectangular Block Operation . . . . .	269
AXI Interface . . . . .	270
AXI Ports that are Unique to this Block . . . . .	270
Block Parameters . . . . .	272
LogiCORE™ Documentation . . . . .	275
Device Support . . . . .	275
<b>Inverter . . . . .</b>	<b>276</b>
Block Parameters . . . . .	276
<b>JTAG Co-Simulation . . . . .</b>	<b>277</b>
Block Parameters . . . . .	277
<b>LFSR . . . . .</b>	<b>280</b>



Block Interface . . . . .	280
Block Parameters . . . . .	280
<b>Logical</b> . . . . .	282
Block Parameters . . . . .	282
Xilinx LogiCORE . . . . .	282
<b>MCode</b> . . . . .	283
Configuring an MCode Block . . . . .	283
MATLAB Language Support . . . . .	284
Block Parameters Dialog Box . . . . .	304
<b>ModelSim</b> . . . . .	305
Block Parameters . . . . .	305
Fine Points . . . . .	307
<b>Mult</b> . . . . .	310
Block Parameters . . . . .	310
LogiCORE™ Documentation . . . . .	311
Device Support . . . . .	311
<b>Multiple Subsystem Generator</b> . . . . .	312
Block Parameters . . . . .	312
Design Generation . . . . .	312
Multiple Clock Support . . . . .	315
Files Generated . . . . .	315
<b>Mux</b> . . . . .	317
Block Parameters . . . . .	317
LogiCORE™ Documentation . . . . .	318
Device Support . . . . .	318
<b>Natural Logarithm</b> . . . . .	319
Block Parameters Dialog Box . . . . .	319
LogiCORE™ Documentation . . . . .	319
Device Support . . . . .	319
<b>Negate</b> . . . . .	320
Block Parameters . . . . .	320
<b>Network-based Ethernet Co-Simulation</b> . . . . .	321
Block Parameters . . . . .	321
See Also . . . . .	322
<b>Opmode</b> . . . . .	323
Block Parameters . . . . .	323
Xilinx LogiCORE . . . . .	324
References . . . . .	324
DSP48A Control Instruction Format . . . . .	325
DSP48 Control Instruction Format . . . . .	326
DSP48E Control Instruction Format . . . . .	327
DSP48E1 Control Instruction Format . . . . .	329
<b>Parallel to Serial</b> . . . . .	332
Block Interface . . . . .	332
Block Parameters . . . . .	332
<b>Pause Simulation</b> . . . . .	333
Block Parameters . . . . .	333
<b>PicoBlaze Instruction Display</b> . . . . .	334
Block Interface . . . . .	334
Block Parameters . . . . .	334

Xilinx LogiCORE . . . . .	334
<b>PicoBlaze Microcontroller</b> . . . . .	335
Block Interface . . . . .	335
Block Parameters . . . . .	335
How to Use the PicoBlaze Assembler . . . . .	336
Device Support . . . . .	336
Known Issues . . . . .	336
PicoBlaze Microprocessor Online Documentation . . . . .	336
<b>PicoBlaze6 Instruction Display</b> . . . . .	337
Block Interface . . . . .	337
Block Parameters . . . . .	337
Xilinx LogiCORE . . . . .	337
<b>PicoBlaze6 Microcontroller</b> . . . . .	338
Block Interface . . . . .	339
Block Parameters . . . . .	340
How to Use the PicoBlaze Assembler . . . . .	340
Device Support . . . . .	341
PicoBlaze6 Microprocessor Online Documentation . . . . .	341
<b>Point-to-point Ethernet Co-Simulation</b> . . . . .	342
Block Parameters . . . . .	342
See Also . . . . .	344
<b>Puncture</b> . . . . .	345
Block Parameters . . . . .	345
<b>Reciprocal</b> . . . . .	346
Block Parameters . . . . .	346
LogiCORE™ Documentation . . . . .	346
Device Support . . . . .	346
<b>Reciprocal SquareRoot</b> . . . . .	347
Block Parameters . . . . .	347
LogiCORE™ Documentation . . . . .	347
Device Support . . . . .	347
<b>Reed-Solomon Decoder 7.1</b> . . . . .	348
Block Interface . . . . .	348
Block Parameters . . . . .	349
LogiCORE™ Documentation . . . . .	352
Device Support . . . . .	352
<b>Reed-Solomon Decoder 8.0</b> . . . . .	353
Block Interface Channels and Pins . . . . .	353
Block Parameters . . . . .	355
LogiCORE™ Documentation . . . . .	358
Device Support . . . . .	358
<b>Reed-Solomon Encoder 7.1</b> . . . . .	359
Block Interface . . . . .	359
Block Parameters . . . . .	361
LogiCORE™ Documentation . . . . .	363
Device Support . . . . .	363
<b>Reed-Solomon Encoder 8.0</b> . . . . .	364
Block Interface Channels and Pins . . . . .	365
Other Optional Pins . . . . .	366
Block Parameters . . . . .	366
LogiCORE™ Documentation . . . . .	368

Device Support .....	368
<b>Register</b> .....	369
Block Interface .....	369
Block Parameters .....	369
LogiCORE™ Documentation .....	369
Device Support .....	369
<b>Reinterpret</b> .....	370
Block Parameters .....	370
LogiCORE™ Documentation .....	371
Device Support .....	371
<b>Relational</b> .....	372
Block Parameters .....	372
LogiCORE™ Documentation .....	372
Device Support .....	372
<b>Reset Generator</b> .....	373
Block Parameters .....	373
<b>Resource Estimator</b> .....	374
Block Parameters .....	374
Perform Resource Estimation Buttons .....	374
Blocks Supported by Resource Estimation .....	375
Viewing ISE Reports .....	376
Known Issues for Resource Estimation .....	376
<b>ROM</b> .....	378
Block Parameters .....	378
LogiCORE™ Documentation .....	379
Device Support .....	379
<b>Register</b> .....	381
Block Interface .....	381
Block Parameters .....	381
Xilinx LogiCORE .....	381
<b>Sample Time</b> .....	382
<b>Scale</b> .....	383
Block Parameters .....	383
Xilinx LogiCore .....	383
<b>Serial to Parallel</b> .....	384
Block Interface .....	384
Block Parameters .....	384
<b>Shared Memory</b> .....	385
Block Interface .....	385
Block Parameters .....	387
LogiCORE™ Documentation .....	388
Device Support .....	388
<b>Shared Memory Read</b> .....	389
FIFO Transactions .....	389
Lockable Memory Transactions .....	389
Block Parameters .....	390
See Also .....	390
<b>Shared Memory Write</b> .....	391
FIFO Transactions .....	391
Lockable Memory Transactions .....	391

Block Parameters . . . . .	392
See Also . . . . .	392
<b>Shift</b> . . . . .	393
Block Parameters . . . . .	393
Xilinx LogiCORE . . . . .	393
<b>Simulation Multiplexer</b> . . . . .	394
Using Subsystem for Simulation and Black Box for Hardware . . . . .	394
Block Parameters . . . . .	395
<b>Single Port RAM</b> . . . . .	396
Block Interface . . . . .	396
Block Parameters . . . . .	396
Write Modes . . . . .	397
Hardware Notes . . . . .	398
Xilinx LogiCORE . . . . .	399
LogiCORE™ Documentation . . . . .	399
Device Support . . . . .	400
<b>Single-Step Simulation</b> . . . . .	401
Block Parameters . . . . .	401
<b>Slice</b> . . . . .	402
Block Parameters . . . . .	402
<b>SquareRoot</b> . . . . .	403
Block Parameters . . . . .	403
LogiCORE™ Documentation . . . . .	403
Device Support . . . . .	403
<b>System Generator</b> . . . . .	404
Token Parameters . . . . .	404
<b>Threshold</b> . . . . .	411
Block Parameters . . . . .	411
Xilinx LogiCORE . . . . .	411
<b>Time Division Demultiplexer</b> . . . . .	412
Block Interface . . . . .	412
Block Parameters . . . . .	413
<b>Time Division Multiplexer</b> . . . . .	414
Block Interface . . . . .	414
Block Parameters . . . . .	414
<b>To FIFO</b> . . . . .	415
Block Parameters . . . . .	415
LogiCORE™ Documentation . . . . .	417
Device Support . . . . .	417
See Also . . . . .	417
<b>To Register</b> . . . . .	418
Block Parameters . . . . .	418
Crossing Clock Domains . . . . .	419
LogiCORE™ Documentation . . . . .	420
Device Support . . . . .	420
See Also . . . . .	420
<b>Toolbar</b> . . . . .	421
Block Interface . . . . .	421
Toolbar Menus . . . . .	422
References . . . . .	422

See Also .....	422
<b>Up Sample</b> .....	423
Block Interface .....	423
Block Parameters .....	424
<b>VDMA Interface 4.0</b> .....	425
Preparing to Use This Block .....	425
xlVDMACreateProject utility .....	430
Block Parameters .....	431
LogiCORE™ Documentation .....	432
Device Support .....	432
<b>VDMA Interface 5.4</b> .....	433
Preparing to Use This Block .....	433
xlVDMACreateProject utility .....	433
Block Parameters .....	435
LogiCORE™ Documentation .....	436
Device Support .....	436
<b>Viterbi Decoder 7.0</b> .....	437
Block Interface .....	437
Block Parameters .....	438
LogiCORE™ Documentation .....	442
Device Support .....	442
<b>Viterbi Decoder 8.0</b> .....	443
Block Interface .....	443
Block Parameters .....	445
LogiCORE™ Documentation .....	449
Device Support .....	449
<b>WaveScope</b> .....	450
Quick Tutorial .....	450
Block Interface .....	453

## Chapter 2: Xilinx Reference Blockset

Communication .....	461
Control Logic .....	461
DSP .....	461
Imaging .....	462
Math .....	462
<b>2 Channel Decimate by 2 MAC FIR Filter</b> .....	463
Block Parameters .....	463
Reference .....	463
<b>2n+1-tap Linear Phase MAC FIR Filter</b> .....	464
Block Parameters .....	464
Reference .....	464
<b>2n-tap Linear Phase MAC FIR Filter</b> .....	465
Block Parameters .....	465
Reference .....	465
<b>2n-tap MAC FIR Filter</b> .....	466
Block Parameters .....	466
Reference .....	466
<b>4-channel 8-tap Transpose FIR Filter</b> .....	467
Block Parameters .....	467

<b>4n-tap MAC FIR Filter</b> .....	468
Block Parameters .....	468
Reference .....	468
<b>5x5Filter</b> .....	469
Block Parameters .....	470
<b>BPSK AWGN Channel</b> .....	471
Block Parameters .....	471
Reference .....	471
<b>CIC Filter</b> .....	472
Block Interface .....	472
Block Parameters .....	473
Reference .....	473
<b>Convolutional Encoder</b> .....	474
Implementation .....	474
Block Interface .....	475
Block Parameters .....	475
<b>CORDIC ATAN</b> .....	476
Block Parameters .....	476
Reference .....	476
<b>CORDIC DIVIDER</b> .....	477
Block Parameters .....	477
Reference .....	477
<b>CORDIC LOG</b> .....	478
Block Parameters .....	478
Reference .....	479
<b>CORDIC SINCOS</b> .....	480
Block Parameters .....	480
Reference .....	480
<b>CORDIC SQRT</b> .....	481
Block Parameters .....	481
Reference .....	482
<b>Dual Port Memory Interpolation MAC FIR Filter</b> .....	483
Block Parameters .....	483
Reference .....	483
<b>Interpolation Filter</b> .....	484
Block Parameters .....	484
Reference .....	484
<b>m-channel n-tap Transpose FIR Filter</b> .....	485
Block Parameters .....	485
<b>Mealy State Machine</b> .....	486
Example .....	487
Block Parameters .....	487
<b>Moore State Machine</b> .....	490
Example .....	491
Block Parameters .....	492
<b>Multipath Fading Channel Model</b> .....	493
Theory .....	493
Implementation .....	494
Block Parameters .....	494
Functions .....	495

Data Format	496
Input	497
Output	498
Timing	498
Initialization	498
Demonstrations	498
Hardware Co-Simulation Example	498
Reference	499
<b>n-tap Dual Port Memory MAC FIR Filter</b>	500
Block Parameters	500
Reference	500
<b>n-tap MAC FIR Filter</b>	501
Block Parameters	501
Reference	501
<b>Registered Mealy State Machine</b>	502
Example	503
Block Parameters	504
<b>Registered Moore State Machine</b>	505
Example	506
Block Parameters	507
<b>Virtex Line Buffer</b>	508
Block Parameters	508
<b>Virtex2 Line Buffer</b>	509
Block Parameters	509
<b>Virtex2 5 Line Buffer</b>	510
Block Parameters	510
<b>White Gaussian Noise Generator</b>	511
4-bit Leap-Forward LFSR	511
Box-Muller Method	512
Block Parameters	512
Reference	512

### Chapter 3: Xilinx XtremeDSP Kit Blockset

<b>XtremeDSP Analog to Digital Converter</b>	514
Block Parameters	514
Data Sheet	514
<b>XtremeDSP Co-Simulation</b>	515
Block Parameters	515
<b>XtremeDSP Digital to Analog Converter</b>	517
Block Parameters	517
Data Sheet	517
<b>XtremeDSP External RAM</b>	518
Block Parameters	518
<b>XtremeDSP LED Flasher</b>	519
Block Parameters	519

### Chapter 4: System Generator Utilities

<b>xlAddTerms</b>	523
Syntax	523

Description .....	523
Examples .....	525
Remarks .....	525
See Also .....	525
<b>xlCache</b> .....	526
Syntax .....	526
Description .....	526
See Also .....	527
<b>xlConfigureSolver</b> .....	528
Syntax .....	528
Description .....	528
Examples .....	528
<b>xlfd_a_denominator</b> .....	529
Syntax .....	529
Description .....	529
See Also .....	529
<b>xlfd_a_numerator</b> .....	530
Syntax .....	530
Description .....	530
See Also .....	530
<b>xlGenerateButton</b> .....	531
Syntax .....	531
Description .....	531
See Also .....	531
<b>xlgetparam and xlsetparam</b> .....	532
Syntax .....	532
Description .....	532
Examples .....	533
See Also .....	533
<b>xlgetparams</b> .....	534
Syntax .....	534
Description .....	534
Examples .....	534
See Also .....	535
<b>xlGetReloadOrder</b> .....	536
Syntax .....	536
Description .....	536
See Also .....	537
<b>xlInstallPlugin</b> .....	538
Syntax .....	538
Description .....	538
Examples .....	538
See Also .....	538
<b>xlLoadChipScopeData</b> .....	539
Syntax .....	539
Description .....	539
Examples .....	539
See Also .....	539
<b>xlSBDBuilder</b> .....	540
Syntax .....	540
Description .....	540



See Also .....	542
<b>xlSetNonMemMap</b> .....	543
Syntax .....	543
Description .....	543
Examples .....	543
See Also .....	543
<b>xlSetUseHDL</b> .....	544
Syntax .....	544
Description .....	544
Examples .....	544
See Also .....	544
<b>xlSwitchLibrary</b> .....	545
Syntax .....	545
Description .....	545
Examples .....	545
<b>xlTBUtils</b> .....	546
Syntax .....	546
Description .....	546
Examples .....	548
Remarks .....	549
See Also .....	549
<b>xlTimingAnalysis</b> .....	550
Syntax .....	550
Description .....	550
Example .....	550
<b>xlUpdateModel</b> .....	551
Syntax .....	551
Description .....	551
Examples .....	553
<b>xlVDMACreateProject</b> .....	554
<b>xlVersion</b> .....	555
Syntax .....	555
Description .....	555
See Also .....	555

## Chapter 5: System Generator GUI Utilities

<b>Xilinx BlockAdd</b> .....	558
How to Invoke .....	558
How to Use .....	558
<b>Xilinx Tools &gt; Save as blockAdd default</b> .....	560
How to Use .....	560
How to Restore the Block Default .....	560
<b>Xilinx BlockConnect</b> .....	561
Simple Connections .....	561
Smart Connections .....	562
<b>Xilinx Tools &gt; Terminate</b> .....	563
How to Use .....	563

## Chapter 6: Programmatic Access

<b>System Generator API for Programmatic Generation</b> .....	567
Introduction .....	567
xBlock .....	568
xInport .....	569
xOutport .....	569
xSignal .....	570
xSub2script .....	570
xBlockHelp .....	572
<b>PG API Examples</b> .....	573
Hello World .....	573
MACC .....	574
MACC in a Masked Subsystem .....	575
<b>PG API Error/Warning Handling &amp; Messages</b> .....	579
xBlock Error Messages .....	579
xInport Error Messages .....	579
xOutport Error Messages .....	580
xSignal Error Messages .....	580
xSub2script Error Messages .....	580
<b>M-Code Access to Hardware Co-Simulation</b> .....	580
Compiling Hardware for Use with M-Hwcosim .....	581
M-Hwcosim Simulation Semantics .....	581
Data Representation .....	582
Interfacing to Hardware from M-Code .....	582
M-Hwcosim Examples .....	583
Automatic Generation of M-Hwcosim Testbench .....	588
Resource Management .....	591
M-Hwcosim MATLAB Class .....	591
M-Hwcosim Shared Memory MATLAB Class .....	596
M-Hwcosim Shared FIFO MATLAB Class .....	598
M-Hwcosim Utility Functions .....	599
<b>Index</b> .....	603

## *Xilinx Blockset*

---

<a href="#">Organization of Blockset Libraries</a>	Describes how the Xilinx blocks are organized into libraries.
<a href="#">Common Options in Block Parameter Dialog Boxes</a>	Describes block parameters that are common to most blocks in the Xilinx blockset.
<a href="#">Block Reference Pages</a>	Alphabetical listing of the Xilinx blockset with detailed descriptions of each block.

## Organization of Blockset Libraries

The Xilinx Blockset contains building blocks for constructing DSP and other digital systems in FPGAs using Simulink. The blocks are grouped into libraries according to their function, and some blocks with broad applicability (e.g., the Gateway I/O blocks) are linked into multiple libraries. The following libraries are provided:

Library	Description
Index	Includes every block in the Xilinx Blockset.
<a href="#">AXI4 Blocks</a>	Includes every block that supports the AXI4 Interface
<a href="#">Basic Element Blocks</a>	Includes standard building blocks for digital logic
<a href="#">Communication Blocks</a>	Includes forward error correction and modulator blocks, commonly used in digital communications systems
<a href="#">Control Logic Blocks</a>	Includes blocks for control circuitry and state machines
<a href="#">Data Type Blocks</a>	Includes blocks that convert data types (includes gateways)
<a href="#">DSP Blocks</a>	Includes Digital Signal Processing (DSP) blocks
<a href="#">Floating-Point Blocks</a>	Includes blocks that support the Floating-Point data type as well as other data types. Only a single data type is supported at a time. For example, a floating-point input produces a floating-point output; a fixed-point input produces a fixed-point output.
<a href="#">Index Blocks</a>	Includes All System Generator blocks
<a href="#">Math Blocks</a>	Includes blocks that implement mathematical functions
<a href="#">Memory Blocks</a>	Includes blocks that implement and access memories
<a href="#">Shared Memory Blocks</a>	Includes blocks that implement and access Xilinx shared memories
<a href="#">Tool Blocks</a>	Includes “Utility” blocks, e.g., code generation (System Generator token), resource estimation, HDL co-simulation, etc

Each block has a background color that indicates the following:

Background Color	Meaning
Blue	Block Goes into the FPGA fabric and is free!!
Green	Block Goes into the FPGA fabric and is a Licensed Core. Go to the Xilinx web site to purchase the Core license.
Yellow	Blocks on the boundary of your design like Gateway, Shared Memory Read, Shared Memory Write, VDMA, etc
White	Utility or Tool
Red Symbol	System Generator Token (control panel)

## AXI4 Blocks

Table 1-1: AXI4 Blocks

Block	Description
AXI FIFO	The Xilinx AXI FIFO block implements a FIFO memory queue with an AXI-compatible block interface.
CIC Compiler 3.0	The Xilinx CIC Compiler provides the ability to design and implement AXI4-Stream-compliant Cascaded Integrator-Comb (CIC) filters for a variety of Xilinx FPGA devices.
Complex Multiplier 5.0	The Complex Multiplier 5.0 block implements AXI4-Stream compliant, high-performance, optimized complex multipliers for Virtex-6 and Spartan-6 devices based on user-specified options.
Convolution Encoder 8.0	The Xilinx Convolution Encoder block implements an encoder for convolution codes. Ordinarily used in tandem with a Viterbi decoder, this block performs forward error correction (FEC) in digital communication systems. This block adheres to the AMBA® AXI4-Stream standard.
DDS Compiler 5.0	The Xilinx DDS (Direct Digital Synthesizer) Compiler 5.0 block implements high performance, optimized Phase Generation and Phase to Sinusoid circuits with AXI4-Stream compliant interfaces for Virtex-6, Spartan-6, Virtex-7 and Kintex-7 devices.
Divider Generator 4.0	The Xilinx Divider Generator 4.0 block creates a circuit for integer division based on Radix-2 non-restoring division, or High-Radix division with prescaling.
Fast Fourier Transform 8.0	The Xilinx Fast Fourier Transform 8.0 block implements the Cooley-Tukey FFT algorithm, a computationally efficient method for calculating the Discrete Fourier Transform (DFT). In addition, the block provides an AXI4-Stream-compliant interface for Virtex-6 and Spartan-6 devices.
FIR Compiler 6.2	The Xilinx FIR Compiler 6.2 block provides users with a way to generate highly parameterizable, area-efficient, high-performance FIR filters with an AXI4-Stream-compliant interface.
FIR Compiler 6.3	The Xilinx FIR Compiler 6.3 block provides users with a way to generate highly parameterizable, area-efficient, high-performance FIR filters with an AXI4-Stream-compliant interface.
Reed-Solomon Decoder 8.0	The Reed-Solomon (RS) codes are block-based error correcting codes with a wide range of applications in digital communications and storage.
Reed-Solomon Encoder 8.0	The Reed-Solomon (RS) codes are block-based error correcting codes with a wide range of applications in digital communications and storage. This block adheres to the AMBA® AXI4-Stream standard.
VDMA Interface 4.0	The VDMA (Video Direct Memory Access) Interface block is a bit-accurate simulation model containing up to 4 AXI VDMA IP LogiCOREs connected to an AXI interconnect and external memory.

Table 1-1: AXI4 Blocks

Block	Description
VDMA Interface 5.4	As shown in the illustration below, the VDMA Interface block's AXI memory-mapped interface is connected to the AXI Interconnect. DDR external memory is connected as the only slave on the AXI Interconnect. All ports except memory-mapped ports of the VDMA block are available on the VDMA Interface block.
Viterbi Decoder 8.0	Data encoded with a convolution encoder can be decoded using the Xilinx Viterbi decoder block. This block adheres to the AMBA® AXI4-Stream standard.

## Basic Element Blocks

Table 1-2: Basic Element Blocks

Block	Description
Absolute	The Xilinx Absolute block outputs the absolute value of the input.
Addressable Shift Register	The Xilinx Addressable Shift Register block is a variable-length shift register in which any register in the delay chain can be addressed and driven onto the output data port.
Assert	The Xilinx Assert block is used to assert a rate and/or a type on a signal. This block has no cost in hardware and can be used to resolve rates and/or types in situations where designer intervention is required.
BitBasher	The Xilinx BitBasher block performs slicing, concatenation and augmentation of inputs attached to the block.
Black Box	The System Generator Black Box block provides a way to incorporate hardware description language (HDL) models into System Generator.
Clock Enable Probe	The Xilinx Clock Enable (CE) Probe provides a mechanism for extracting derived clock enable signals from Xilinx signals in System Generator models.
Concat	The Xilinx Concat block performs a concatenation of n bit vectors represented by unsigned integer numbers, for example, n unsigned numbers with binary points at position zero.
Constant	The Xilinx Constant block generates a constant that can be a fixed-point value, a Boolean value, or a DSP48 instruction. This block is similar to the Simulink constant block, but can be used to directly drive the inputs on Xilinx blocks.
Convert	The Xilinx Convert block converts each input sample to a number of a desired arithmetic type. For example, a number can be converted to a signed (two's complement) or unsigned value.
Counter	The Xilinx Counter block implements a free running or count-limited type of an up, down, or up/down counter. The counter output can be specified as a signed or unsigned fixed-point number.
Delay	The Xilinx Delay block implements a fixed delay of L cycles.

Table 1-2: Basic Element Blocks

Block	Description
Down Sample	The Xilinx Down Sample block reduces the sample rate at the point where the block is placed in your design.
Expression	The Xilinx Expression block performs a bitwise logical expression.
Gateway In	The Xilinx Gateway In blocks are the inputs into the Xilinx portion of your Simulink design. These blocks convert Simulink integer, double and fixed-point data types into the System Generator fixed-point type. Each block defines a top-level input port in the HDL design generated by System Generator.
Gateway Out	Xilinx Gateway Out blocks are the outputs from the Xilinx portion of your Simulink design. This block converts the System Generator fixed-point or floating-point data type into a Simulink integer, single, double or fixed-point data type.
Inverter	The Xilinx Inverter block calculates the bitwise logical complement of a fixed-point number. The block is implemented as a synthesizable VHDL module.
LFSR	The Xilinx LFSR block implements a Linear Feedback Shift Register (LFSR). This block supports both the Galois and Fibonacci structures using either the XOR or XNOR gate and allows a re-loadable input to change the current value of the register at any time. The LFSR output and re-loadable input can be configured as either serial or parallel ports
Logical	The Xilinx Logical block performs bitwise logical operations on fixed-point numbers. Operands are zero padded and sign extended as necessary to make binary point positions coincide; then the logical operation is performed and the result is delivered at the output port.
Mux	The Xilinx Mult block implements a multiplier. It computes the product of the data on its two input ports, producing the result on its output port.
Parallel to Serial	The Parallel to Serial block takes an input word and splits it into N time-multiplexed output words where N is the ratio of number of input bits to output bits. The order of the output can be either least significant bit first or most significant bit first.
Register	The Xilinx Register block models a D flip-flop-based register, having latency of one sample period.
Reinterpret	The Xilinx Reinterpret block forces its output to a new type without any regard for retaining the numerical value represented by the input.
Relational	The Xilinx Relational block implements a comparator.
Reset Generator	The Reset Generator block captures the user's reset signal that is running at the system sample rate, and produces one or more downsampled reset signal(s) running at the rates specified on the block.
Serial to Parallel	The Serial to Parallel block takes a series of inputs of any size and creates a single output of a specified multiple of that size. The input series can be ordered either with the most significant word first or the least significant word first.

Table 1-2: Basic Element Blocks

Block	Description
Slice	The Xilinx Slice block allows you to slice off a sequence of bits from your input data and create a new data value. This value is presented as the output from the block. The output data type is unsigned with its binary point at zero.
System Generator	The System Generator token serves as a control panel for controlling system and simulation parameters, and it is also used to invoke the code generator for netlisting. Every Simulink model containing any element from the Xilinx Blockset must contain at least one System Generator token. Once a System Generator token is added to a model, it is possible to specify how code generation and simulation should be handled.
Time Division Demultiplexer	The Xilinx Time Division Demultiplexer block accepts input serially and presents it to multiple outputs at a slower rate.
Time Division Multiplexer	The Xilinx Time Division Multiplexer block multiplexes values presented at input ports into a single faster rate output stream.
Up Sample	The Xilinx Up Sample block increases the sample rate at the point where the block is placed in your design. The output sample period is $1/n$ , where $l$ is the input sample period and $n$ is the sampling rate.

## Communication Blocks

Table 1-3: Communication Blocks - FEC

Communication Block	Description
Convolution Encoder 7.0	The Xilinx Convolution Encoder block implements an encoder for convolution codes. Ordinarily used in tandem with a Viterbi decoder, this block performs forward error correction (FEC) in digital communication systems.
Convolution Encoder 8.0	The Xilinx Convolution Encoder block implements an encoder for convolution codes. Ordinarily used in tandem with a Viterbi decoder, this block performs forward error correction (FEC) in digital communication systems. This block adheres to the AMBA® AXI4-Stream standard.
Depuncture	The Xilinx Depuncture block allows you to insert an arbitrary symbol into your input data at the location specified by the depuncture code.
Interleaver/De-interleaver 6.0	The Xilinx Interleaver Deinterleaver block implements an interleaver or a deinterleaver. An interleaver is a device that rearranges the order of a sequence of input symbols. The term symbol is used to describe a collection of bits. In some applications, a symbol is a single bit. In others, a symbol is a bus.
Interleaver/De-interleaver 7.0	The classic use of interleaving is to randomize the location of errors introduced in signal transmission. Interleaving spreads a burst of errors out so that error correction circuits have a better chance of correcting the data.



**Table 1-3: Communication Blocks - FEC**

<b>Communication Block</b>	<b>Description</b>
Interleaver/De-interleaver 7.1	If a particular interleaver is used at the transmit end of a channel, the inverse of that interleaver must be used at the receive end to recover the original data. The inverse interleaver is referred to as a de-interleaver.
Puncture	The Xilinx Puncture block removes a set of user-specified bits from the input words of its data stream.
Reed-Solomon Decoder 7.1	The Reed-Solomon (RS) codes are block-based error correcting codes with a wide range of applications in digital communications and storage.
Reed-Solomon Decoder 8.0	The Reed-Solomon (RS) codes are block-based error correcting codes with a wide range of applications in digital communications and storage.
Reed-Solomon Encoder 7.1	The Reed-Solomon (RS) codes are block-based error correcting codes with a wide range of applications in digital communications and storage.
Reed-Solomon Encoder 8.0	The Reed-Solomon (RS) codes are block-based error correcting codes with a wide range of applications in digital communications and storage. This block adheres to the AMBA® AXI4-Stream standard.
Viterbi Decoder 7.0	Data encoded with a convolution encoder can be decoded using the Xilinx Viterbi decoder block.
Viterbi Decoder 8.0	Data encoded with a convolution encoder can be decoded using the Xilinx Viterbi decoder block. This block adheres to the AMBA® AXI4-Stream standard.

## Control Logic Blocks

**Table 1-4: Control Logic Blocks**

<b>Control Logic Block</b>	<b>Description</b>
AXI FIFO	The Xilinx AXI FIFO block implements a FIFO memory queue with an AXI-compatible block interface.
Black Box	The System Generator Black Box block provides a way to incorporate hardware description language (HDL) models into System Generator.
Constant	The Xilinx Constant block generates a constant that can be a fixed-point value, a Boolean value, or a DSP48 instruction. This block is similar to the Simulink constant block, but can be used to directly drive the inputs on Xilinx blocks.
Counter	The Xilinx Counter block implements a free running or count-limited type of an up, down, or up/down counter. The counter output can be specified as a signed or unsigned fixed-point number.
Dual Port RAM	The Xilinx Dual Port RAM block implements a random access memory (RAM). Dual ports enable simultaneous access to the memory space at different sample rates using multiple data widths.

Table 1-4: Control Logic Blocks

Control Logic Block	Description
EDK Processor	The EDK Processor block allows user logic developed in System Generator to be attached to embedded processor systems created using the Xilinx Embedded Development Kit (EDK).
Expression	The Xilinx Expression block performs a bitwise logical expression.
FIFO	The Xilinx FIFO block implements an FIFO memory queue.
Inverter	The Xilinx Inverter block calculates the bitwise logical complement of a fixed-point number. The block is implemented as a synthesizable VHDL module.
Logical	The Xilinx Logical block performs bitwise logical operations on fixed-point numbers. Operands are zero padded and sign extended as necessary to make binary point positions coincide; then the logical operation is performed and the result is delivered at the output port.
MCode	The Xilinx MCode block is a container for executing a user-supplied MATLAB function within Simulink. A parameter on the block specifies the M-function name. The block executes the M-code to calculate block outputs during a Simulink simulation. The same code is translated in a straightforward way into equivalent behavioral VHDL/Verilog when hardware is generated.
Mux	The Xilinx Mux block implements a multiplexer. The block has one select input (type unsigned) and a user-configurable number of data bus inputs, ranging from 2 to 1024.
PicoBlaze Instruction Display	The PicoBlaze Instruction Display block takes an encoded 18-bit PicoBlaze instruction and a 10 bit address and displays the decoded instruction and the program counter on the block icon. This feature is useful when debugging PicoBlaze designs and can be used in conjunction with the Single-Step Simulation block to step through each instruction.
PicoBlaze Microcontroller	The Xilinx PicoBlaze Microcontroller block implements an embedded 8-bit microcontroller using the PicoBlaze macro.
PicoBlaze6 Instruction Display	The PicoBlaze6™ Instruction Display block takes an encoded 18-bit picoblaze6 instruction and PicoBlaze address output and displays the decoded instruction and the program counter on the block icon. This feature is useful when debugging PicoBlaze6 designs and can be used in conjunction with the Single-Step Simulation block to step through each instruction.
PicoBlaze6 Microcontroller	The Xilinx PicoBlaze6™ Microcontroller block implements an 8-bit microcontroller.
Relational	The Xilinx Relational block implements a comparator.
ROM	The Xilinx ROM block is a single port read-only memory (ROM).
Shift	The Xilinx Shift block performs a left or right shift on the input signal. The result will have the same fixed-point container as that of the input.

Table 1-4: Control Logic Blocks

Control Logic Block	Description
Single Port RAM	The Xilinx Single Port RAM block implements a random access memory (RAM) with one data input and one data output port.
Slice	The Xilinx Slice block allows you to slice off a sequence of bits from your input data and create a new data value. This value is presented as the output from the block. The output data type is unsigned with its binary point at zero.

## Data Type Blocks

Table 1-5: Data Type Blocks

Data Type Block	Description
BitBasher	The Xilinx BitBasher block performs slicing, concatenation and augmentation of inputs attached to the block.
Concat	The Xilinx Concat block performs a concatenation of n bit vectors represented by unsigned integer numbers, for example, n unsigned numbers with binary points at position zero.
Convert	The Xilinx Convert block converts each input sample to a number of a desired arithmetic type. For example, a number can be converted to a signed (two's complement) or unsigned value.
Gateway In	The Xilinx Gateway In blocks are the inputs into the Xilinx portion of your Simulink design. These blocks convert Simulink integer, double and fixed-point data types into the System Generator fixed-point type. Each block defines a top-level input port in the HDL design generated by System Generator.
Gateway Out	Xilinx Gateway Out blocks are the outputs from the Xilinx portion of your Simulink design. This block converts the System Generator fixed-point or floating-point data type into a Simulink integer, single, double or fixed-point data type.
Parallel to Serial	The Parallel to Serial block takes an input word and splits it into N time-multiplexed output words where N is the ratio of number of input bits to output bits. The order of the output can be either least significant bit first or most significant bit first.
Reinterpret	The Xilinx Reinterpret block forces its output to a new type without any regard for retaining the numerical value represented by the input.
Scale	The Xilinx Scale block scales its input by a power of two. The power can be either positive or negative. The block has one input and one output. The scale operation has the effect of moving the binary point without changing the bits in the container
Serial to Parallel	The Serial to Parallel block takes a series of inputs of any size and creates a single output of a specified multiple of that size. The input series can be ordered either with the most significant word first or the least significant word first.

Table 1-5: Data Type Blocks

Data Type Block	Description
Shift	The Xilinx Shift block performs a left or right shift on the input signal. The result will have the same fixed-point container as that of the input.
Slice	The Xilinx Slice block allows you to slice off a sequence of bits from your input data and create a new data value. This value is presented as the output from the block. The output data type is unsigned with its binary point at zero.

## DSP Blocks

Table 1-6: DSP Blocks

DSP Block	Description
CIC Compiler 2.0	The Xilinx CIC Compiler provides the ability to design and implement Cascaded Integrator-Comb (CIC) filters for a variety of Xilinx FPGA devices.
CIC Compiler 3.0	The Xilinx CIC Compiler provides the ability to design and implement AXI4-Stream-compliant Cascaded Integrator-Comb (CIC) filters for a variety of Xilinx FPGA devices.
Complex Multiplier 3.1	The Xilinx Complex Multiplier block multiplies two complex numbers.
Complex Multiplier 5.0	The Complex Multiplier 5.0 block implements AXI4-Stream compliant, high-performance, optimized complex multipliers for Virtex-6 and Spartan-6 devices based on user-specified options.
CORDIC 4.0	The Xilinx CORDIC 4.0 block implements a generalized coordinate rotational digital computer (CORDIC) algorithm.
CORDIC 5.0	The Xilinx CORDIC 5.0 block implements a generalized coordinate rotational digital computer (CORDIC) algorithm and is AXI compliant.
DDS Compiler 4.0	The Xilinx DDS Compiler block is a direct digital synthesizer, also commonly called a numerically controlled oscillator (NCO). The block uses a lookup table scheme to generate sinusoids. A digital integrator (accumulator) generates a phase that is mapped by the lookup table into the output sinusoidal waveform.
DDS Compiler 5.0	The Xilinx DDS (Direct Digital Synthesizer) Compiler 5.0 block implements high performance, optimized Phase Generation and Phase to Sinusoid circuits with AXI4-Stream compliant interfaces for Virtex-6, Spartan-6, Virtex-7 and Kintex-7 devices.
Divider Generator 3.0	The Xilinx Divider Generator 3.0 block creates a circuit for integer division based on Radix-2 non-restoring division, or High-Radix division with prescaling.
Divider Generator 4.0	The Xilinx Divider Generator 4.0 block creates a circuit for integer division based on Radix-2 non-restoring division, or High-Radix division with prescaling.

**Table 1-6: DSP Blocks**

DSP Block	Description
DSP48	The Xilinx DSP48 block is an efficient building block for DSP applications that use Xilinx Virtex®-4 devices. The DSP48 combines an 18-bit by 18-bit signed multiplier with a 48-bit adder and programmable mux to select the adder's input.
DSP48 Macro	The System Generator DSP48 Macro block provides a device independent abstraction of the blocks DSP48, DSP48A, and DSP48E. Using this block instead of using a technology-specific DSP slice helps makes the design more portable between Xilinx technologies.
DSP48 macro 2.0	The System Generator DSP48 macro 2.0 block provides a device independent abstraction of the blocks DSP48, DSP48A, and DSP48E. Using this block instead of using a technology-specific DSP slice helps makes the design more portable between Xilinx technologies.
DSP48 Macro 2.1	The System Generator DSP48 macro 2.1 block provides a device independent abstraction of the blocks DSP48, DSP48A, and DSP48E. Using this block instead of using a technology-specific DSP slice helps makes the design more portable between Xilinx technologies.
DSP48A	The Xilinx DSP48A block is an efficient building block for DSP applications that use Xilinx Spartan-3A DSP devices. For those familiar with the DSP48 and the DSP48E, the DSP48A is a 'light' version of primitive.
DSP48E	The Xilinx DSP48E block is an efficient building block for DSP applications that use Xilinx Virtex®-5 devices. The DSP48E combines an 18-bit by 25-bit signed multiplier with a 48-bit adder and programmable mux to select the adder's input.
DSP48E1	The Xilinx DSP48E1 block is an efficient building block for DSP applications that use Xilinx Virtex®-6 and 7 series devices. Enhancements to the DSP48E1 slice provide improved flexibility and utilization, improved efficiency of applications, reduced overall power consumption, and increased maximum frequency. The high performance allows designers to implement multiple slower operations in a single DSP48E1 slice using time-multiplexing methods.
Fast Fourier Transform 7.1	The Xilinx Fast Fourier Transform 7.1 block implements an efficient algorithm for computing the Discrete Fourier Transform (DFT).
Fast Fourier Transform 8.0	The Xilinx Fast Fourier Transform 8.0 block implements the Cooley-Tukey FFT algorithm, a computationally efficient method for calculating the Discrete Fourier Transform (DFT). In addition, the block provides an AXI4-Stream-compliant interface for Virtex-6 and Spartan-6 devices.
FDATool	The Xilinx FDATool block provides an interface to the FDATool software available as part of the MATLAB Signal Processing Toolbox.
FIR Compiler 5.0	The Xilinx FIR Compiler 5.0 block implements a Multiply Accumulate-based or Distributed-Arithmetic FIR filter. It accepts a stream of input data and computes filtered output with a fixed delay, based on the filter configuration. The MAC-based filter is implemented using cascaded Xtreme DSP slices when available as shown in the figure below.

Table 1-6: DSP Blocks

DSP Block	Description
FIR Compiler 6.2	The Xilinx FIR Compiler 6.2 block provides users with a way to generate highly parameterizable, area-efficient, high-performance FIR filters with an AXI4-Stream-compliant interface.
FIR Compiler 6.3	The Xilinx FIR Compiler 6.3 block provides users with a way to generate highly parameterizable, area-efficient, high-performance FIR filters with an AXI4-Stream-compliant interface.
LFSR	The Xilinx LFSR block implements a Linear Feedback Shift Register (LFSR). This block supports both the Galois and Fibonacci structures using either the XOR or XNOR gate and allows a re-loadable input to change the current value of the register at any time. The LFSR output and re-loadable input can be configured as either serial or parallel ports
Opmode	The Xilinx Opmode block generates a constant that is a DSP48A, DSP48, DS48E, or DSP48E1 instruction. The instruction is an 11-bit value for the DSP48, 8-bit for DSP48A, 15-bit value for the DSP48E and a 20-bit value for DSP48E1. The instruction can consists of the opmode, carry-in, carry-in select, inmode and either the subtract or alumode bits (depending upon the selection of DSP48 or DSP48E type).

## Floating-Point Blocks

The blocks in this library support the Floating-Point data type as well as other data types. Only a single data type is supported at a time. For example, a floating-point input produces a floating-point output; a fixed-point input produces a fixed-point output.

Table 1-7: Floating-Point Blocks

Index Block	Description
Absolute	The Xilinx Absolute block outputs the absolute value of the input.
AXI FIFO	The Xilinx AXI FIFO block implements a FIFO memory queue with an AXI-compatible block interface.
Addressable Shift Register	The Xilinx Addressable Shift Register block is a variable-length shift register in which any register in the delay chain can be addressed and driven onto the output data port.
AddSub	The Xilinx AddSub block implements an adder/subtractor. The operation can be fixed (Addition or Subtraction) or changed dynamically under control of the sub mode signal.
Assert	The Xilinx Assert block is used to assert a rate and/or a type on a signal. This block has no cost in hardware and can be used to resolve rates and/or types in situations where designer intervention is required.
Black Box	The System Generator Black Box block provides a way to incorporate hardware description language (HDL) models into System Generator.
CMult	The Xilinx CMult block implements a gain operator, with output equal to the product of its input by a constant value. This value can be a MATLAB expression that evaluates to a constant.

**Table 1-7: Floating-Point Blocks**

<b>Index Block</b>	<b>Description</b>
Constant	The Xilinx Constant block generates a constant that can be a fixed-point value, a Boolean value, or a DSP48 instruction. This block is similar to the Simulink constant block, but can be used to directly drive the inputs on Xilinx blocks.
Convert	The Xilinx Convert block converts each input sample to a number of a desired arithmetic type. For example, a number can be converted to a signed (two's complement) or unsigned value.
Delay	The Xilinx Delay block implements a fixed delay of L cycles.
Divide	The Xilinx Divide block performs both fixed-point and floating-point division with the a input being the dividend and the b input the divisor. Both inputs must be of the same data type.
Dual Port RAM	The Xilinx Dual Port RAM block implements a random access memory (RAM). Dual ports enable simultaneous access to the memory space at different sample rates using multiple data widths.
Fast Fourier Transform 8.0	The Xilinx Fast Fourier Transform 8.0 block implements the Cooley-Tukey FFT algorithm, a computationally efficient method for calculating the Discrete Fourier Transform (DFT). In addition, the block provides an AXI4-Stream-compliant interface for Virtex-6 and Spartan-6 devices.
FIFO	The Xilinx FIFO block implements an FIFO memory queue.
From FIFO	The Xilinx From FIFO block implements the trailing half of a first-in-first-out memory queue.
From Register	The Xilinx From Register block implements the trailing half of a D flip-flop based register. The physical register can be shared among two designs or two portions of the same design.
Gateway In	The Xilinx Gateway In blocks are the inputs into the Xilinx portion of your Simulink design. These blocks convert Simulink integer, double and fixed-point data types into the System Generator fixed-point type. Each block defines a top-level input port in the HDL design generated by System Generator.
Gateway Out	Xilinx Gateway Out blocks are the outputs from the Xilinx portion of your Simulink design. This block converts the System Generator fixed-point or floating-point data type into a Simulink integer, single, double or fixed-point data type.
Mult	The Xilinx Mult block implements a multiplier. It computes the product of the data on its two input ports, producing the result on its output port.
Mux	The Xilinx Mux block implements a multiplexer. The block has one select input (type unsigned) and a user-configurable number of data bus inputs, ranging from 2 to 1024.
Natural Logarithm	The Xilinx Natural Logarithm block produces the natural logarithm of the input.
Negate	The Xilinx Negate block computes the arithmetic negation of its input.
Reciprocal	The Xilinx Reciprocal block performs the reciprocal on the input. Currently, only the floating-point data type is supported.

Table 1-7: Floating-Point Blocks

Index Block	Description
Reciprocal SquareRoot	The Xilinx Reciprocal SquareRoot block performs the reciprocal squareroot on the input. Currently, only the floating-point data type is supported.
Reinterpret	The Xilinx Reinterpret block forces its output to a new type without any regard for retaining the numerical value represented by the input.
Relational	The Xilinx Relational block implements a comparator.
ROM	The Xilinx ROM block is a single port read-only memory (ROM).
Shared Memory	The Xilinx Shared Memory block implements a random access memory (RAM) that can be shared among multiple designs or sections of a design.
Single Port RAM	The Xilinx Single Port RAM block implements a random access memory (RAM) with one data input and one data output port.
SquareRoot	The Xilinx SquareRoot block performs the square root on the input. Currently, only the floating-point data type is supported.
To FIFO	The Xilinx To FIFO block implements the leading half of a first-in-first-out memory queue.
To Register	The Xilinx To Register block implements the leading half of a D flip-flop based register, having latency of one sample period. The register can be shared among multiple designs or sections of a design.
WaveScope	The System Generator WaveScope block provides a powerful and easy-to-use waveform viewer for analyzing and debugging System Generator designs.

## Index Blocks

Table 1-8: Index Blocks

Index Block	Description
Absolute	The Xilinx Absolute block outputs the absolute value of the input.
Accumulator	The Xilinx Accumulator block implements an adder or subtractor-based scaling accumulator.
Addressable Shift Register	The Xilinx Addressable Shift Register block is a variable-length shift register in which any register in the delay chain can be addressed and driven onto the output data port.
AddSub	The Xilinx AddSub block implements an adder/subtractor. The operation can be fixed (Addition or Subtraction) or changed dynamically under control of the sub mode signal.
Assert	The Xilinx Assert block is used to assert a rate and/or a type on a signal. This block has no cost in hardware and can be used to resolve rates and/or types in situations where designer intervention is required.
AXI FIFO	The Xilinx AXI FIFO block implements a FIFO memory queue with an AXI-compatible block interface.



**Table 1-8: Index Blocks**

<b>Index Block</b>	<b>Description</b>
BitBasher	The Xilinx BitBasher block performs slicing, concatenation and augmentation of inputs attached to the block.
Black Box	The System Generator Black Box block provides a way to incorporate hardware description language (HDL) models into System Generator.
ChipScope	The Xilinx ChipScope™ block enables run-time debugging and verification of signals within an FPGA.
CIC Compiler 2.0	The Xilinx CIC Compiler provides the ability to design and implement Cascaded Integrator-Comb (CIC) filters for a variety of Xilinx FPGA devices.
CIC Compiler 3.0	The Xilinx CIC Compiler provides the ability to design and implement AXI4-Stream-compliant Cascaded Integrator-Comb (CIC) filters for a variety of Xilinx FPGA devices.
Clock Enable Probe	The Xilinx Clock Enable (CE) Probe provides a mechanism for extracting derived clock enable signals from Xilinx signals in System Generator models.
Clock Probe	The Xilinx Clock Probe generates a double-precision representation of a clock signal with a period equal to the Simulink system period.
CMult	The Xilinx CMult block implements a gain operator, with output equal to the product of its input by a constant value. This value can be a MATLAB expression that evaluates to a constant.
Complex Multiplier 3.1	The Xilinx Complex Multiplier block multiplies two complex numbers.
Complex Multiplier 5.0	The Complex Multiplier 5.0 block implements AXI4-Stream compliant, high-performance, optimized complex multipliers for Virtex-6 and Spartan-6 devices based on user-specified options.
Concat	The Xilinx Concat block performs a concatenation of n bit vectors represented by unsigned integer numbers, for example, n unsigned numbers with binary points at position zero.
Configurable Subsystem Manager	The Xilinx Configurable Subsystem Manager extends Simulink's configurable subsystem capabilities to allow a subsystem configurations to be selected for hardware generation as well as for simulation.
Constant	The Xilinx Constant block generates a constant that can be a fixed-point value, a Boolean value, or a DSP48 instruction. This block is similar to the Simulink constant block, but can be used to directly drive the inputs on Xilinx blocks.
Convert	The Xilinx Convert block converts each input sample to a number of a desired arithmetic type. For example, a number can be converted to a signed (two's complement) or unsigned value.
Convolution Encoder 7.0	The Xilinx Convolution Encoder block implements an encoder for convolution codes. Ordinarily used in tandem with a Viterbi decoder, this block performs forward error correction (FEC) in digital communication systems.

Table 1-8: Index Blocks

Index Block	Description
Convolution Encoder 8.0	The Xilinx Convolution Encoder block implements an encoder for convolution codes. Ordinarily used in tandem with a Viterbi decoder, this block performs forward error correction (FEC) in digital communication systems. This block adheres to the AMBA® AXI4-Stream standard.
CORDIC 4.0	The Xilinx CORDIC 4.0 block implements a generalized coordinate rotational digital computer (CORDIC) algorithm.
CORDIC 5.0	The Xilinx CORDIC 5.0 block implements a generalized coordinate rotational digital computer (CORDIC) algorithm and is AXI compliant.
Counter	The Xilinx Counter block implements a free running or count-limited type of an up, down, or up/down counter. The counter output can be specified as a signed or unsigned fixed-point number.
DDS Compiler 4.0	The Xilinx DDS Compiler block is a direct digital synthesizer, also commonly called a numerically controlled oscillator (NCO). The block uses a lookup table scheme to generate sinusoids. A digital integrator (accumulator) generates a phase that is mapped by the lookup table into the output sinusoidal waveform.
DDS Compiler 5.0	The Xilinx DDS (Direct Digital Synthesizer) Compiler 5.0 block implements high performance, optimized Phase Generation and Phase to Sinusoid circuits with AXI4-Stream compliant interfaces for Virtex-6, Spartan-6, Virtex-7 and Kintex-7 devices.
Delay	The Xilinx Delay block implements a fixed delay of L cycles.
Depuncture	The Xilinx Depuncture block allows you to insert an arbitrary symbol into your input data at the location specified by the depuncture code.
Divide	The Xilinx Divide block performs both fixed-point and floating-point division with the a input being the dividend and the b input the divisor. Both inputs must be of the same data type.
Divider Generator 3.0	The Xilinx Divider Generator 3.0 block creates a circuit for integer division based on Radix-2 non-restoring division, or High-Radix division with prescaling.
Divider Generator 4.0	The Xilinx Divider Generator 4.0 block creates a circuit for integer division based on Radix-2 non-restoring division, or High-Radix division with prescaling.
Down Sample	The Xilinx Down Sample block reduces the sample rate at the point where the block is placed in your design.
DSP48	The Xilinx DSP48 block is an efficient building block for DSP applications that use Xilinx Virtex®-4 devices. The DSP48 combines an 18-bit by 18-bit signed multiplier with a 48-bit adder and programmable mux to select the adder's input.
DSP48 Macro	The System Generator DSP48 Macro block provides a device independent abstraction of the blocks DSP48, DSP48A, and DSP48E. Using this block instead of using a technology-specific DSP slice helps makes the design more portable between Xilinx technologies.

**Table 1-8: Index Blocks**

<b>Index Block</b>	<b>Description</b>
DSP48 macro 2.0	The System Generator DSP48 macro 2.0 block provides a device independent abstraction of the blocks DSP48, DSP48A, and DSP48E. Using this block instead of using a technology-specific DSP slice helps makes the design more portable between Xilinx technologies.
DSP48 Macro 2.1	The System Generator DSP48 macro 2.1 block provides a device independent abstraction of the blocks DSP48, DSP48A, and DSP48E. Using this block instead of using a technology-specific DSP slice helps makes the design more portable between Xilinx technologies.
DSP48A	The Xilinx DSP48A block is an efficient building block for DSP applications that use Xilinx Spartan-3A DSP devices. For those familiar with the DSP48 and the DSP48E, the DSP48A is a 'light' version of primitive.
DSP48E	The Xilinx DSP48E block is an efficient building block for DSP applications that use Xilinx Virtex®-5 devices. The DSP48E combines an 18-bit by 25-bit signed multiplier with a 48-bit adder and programmable mux to select the adder's input.
DSP48E1	The Xilinx DSP48E1 block is an efficient building block for DSP applications that use Xilinx Virtex®-6 and 7 series devices. Enhancements to the DSP48E1 slice provide improved flexibility and utilization, improved efficiency of applications, reduced overall power consumption, and increased maximum frequency. The high performance allows designers to implement multiple slower operations in a single DSP48E1 slice using time-multiplexing methods.
Dual Port RAM	The Xilinx Dual Port RAM block implements a random access memory (RAM). Dual ports enable simultaneous access to the memory space at different sample rates using multiple data widths.
EDK Processor	The EDK Processor block allows user logic developed in System Generator to be attached to embedded processor systems created using the Xilinx Embedded Development Kit (EDK).
Expression	The Xilinx Expression block performs a bitwise logical expression.
Fast Fourier Transform 7.1	The Xilinx Fast Fourier Transform 7.1 block implements an efficient algorithm for computing the Discrete Fourier Transform (DFT).
Fast Fourier Transform 8.0	The Xilinx Fast Fourier Transform 8.0 block implements the Cooley-Tukey FFT algorithm, a computationally efficient method for calculating the Discrete Fourier Transform (DFT). In addition, the block provides an AXI4-Stream-compliant interface for Virtex-6 and Spartan-6 devices.
FDATool	The Xilinx FDATool block provides an interface to the FDATool software available as part of the MATLAB Signal Processing Toolbox.
FIFO	The Xilinx FIFO block implements an FIFO memory queue.
FIR Compiler 5.0	The Xilinx FIR Compiler 5.0 block implements a Multiply Accumulate-based or Distributed-Arithmetic FIR filter. It accepts a stream of input data and computes filtered output with a fixed delay, based on the filter configuration. The MAC-based filter is implemented using cascaded Xtreme DSP slices when available as shown in the figure below.

Table 1-8: Index Blocks

Index Block	Description
FIR Compiler 6.2	The Xilinx FIR Compiler 6.2 block provides users with a way to generate highly parameterizable, area-efficient, high-performance FIR filters with an AXI4-Stream-compliant interface.
FIR Compiler 6.3	The Xilinx FIR Compiler 6.3 block provides users with a way to generate highly parameterizable, area-efficient, high-performance FIR filters with an AXI4-Stream-compliant interface.
From FIFO	The Xilinx From FIFO block implements the trailing half of a first-in-first-out memory queue.
From Register	The Xilinx From Register block implements the trailing half of a D flip-flop based register. The physical register can be shared among two designs or two portions of the same design.
Gateway In	The Xilinx Gateway In blocks are the inputs into the Xilinx portion of your Simulink design. These blocks convert Simulink integer, double and fixed-point data types into the System Generator fixed-point type. Each block defines a top-level input port in the HDL design generated by System Generator.
Gateway Out	Xilinx Gateway Out blocks are the outputs from the Xilinx portion of your Simulink design. This block converts the System Generator fixed-point or floating-point data type into a Simulink integer, single, double or fixed-point data type.
Indeterminate Probe	The output of the Xilinx Indeterminate Probe indicates whether the input data is indeterminate (MATLAB value NaN). An indeterminate data value corresponds to a VHDL indeterminate logic data value of 'X'.
Interleaver/De-interleaver 6.0	The Xilinx Interleaver Deinterleaver block implements an interleaver or a deinterleaver. An interleaver is a device that rearranges the order of a sequence of input symbols. The term symbol is used to describe a collection of bits. In some applications, a symbol is a single bit. In others, a symbol is a bus.
Interleaver/De-interleaver 7.0	The classic use of interleaving is to randomize the location of errors introduced in signal transmission. Interleaving spreads a burst of errors out so that error correction circuits have a better chance of correcting the data.
Interleaver/De-interleaver 7.1	If a particular interleaver is used at the transmit end of a channel, the inverse of that interleaver must be used at the receive end to recover the original data. The inverse interleaver is referred to as a de-interleaver.
Inverter	The Xilinx Inverter block calculates the bitwise logical complement of a fixed-point number. The block is implemented as a synthesizable VHDL module.
JTAG Co-Simulation	The Xilinx JTAG Co-Simulation block allows you to perform hardware co-simulation using JTAG and a Parallel Cable IV or Platform USB. The JTAG hardware co-simulation interface takes advantage of the ubiquity of JTAG to extend System Generator's hardware in the simulation loop capability to numerous other FPGA platforms.

**Table 1-8: Index Blocks**

<b>Index Block</b>	<b>Description</b>
LFSR	The Xilinx LFSR block implements a Linear Feedback Shift Register (LFSR). This block supports both the Galois and Fibonacci structures using either the XOR or XNOR gate and allows a re-loadable input to change the current value of the register at any time. The LFSR output and re-loadable input can be configured as either serial or parallel ports
Logical	The Xilinx Logical block performs bitwise logical operations on fixed-point numbers. Operands are zero padded and sign extended as necessary to make binary point positions coincide; then the logical operation is performed and the result is delivered at the output port.
MCode	The Xilinx MCode block is a container for executing a user-supplied MATLAB function within Simulink. A parameter on the block specifies the M-function name. The block executes the M-code to calculate block outputs during a Simulink simulation. The same code is translated in a straightforward way into equivalent behavioral VHDL/Verilog when hardware is generated.
ModelSim	The System Generator Black Box block provides a way to incorporate existing HDL files into a model. When the model is simulated, co-simulation can be used to allow black boxes to participate. The ModelSim HDL co-simulation block configures and controls co-simulation for one or several black boxes.
Mult	The Xilinx Mult block implements a multiplier. It computes the product of the data on its two input ports, producing the result on its output port.
Multiple Subsystem Generator	The Xilinx Multiple Subsystem Generator block wires two or more System Generator designs into a single top-level HDL component that incorporates multiple clock domains. This top-level component includes the logic associated with each System Generator design and additional logic to allow the designs to communicate with one another.
Mux	The Xilinx Mux block implements a multiplexer. The block has one select input (type unsigned) and a user-configurable number of data bus inputs, ranging from 2 to 1024.
Natural Logarithm	The Xilinx Natural Logarithm block produces the natural logarithm of the input.
Negate	The Xilinx Negate block computes the arithmetic negation of its input.
Network-based Ethernet Co-Simulation	The Xilinx Network-based Ethernet Co-Simulation block provides an interface to perform hardware co-simulation through an Ethernet connection over the IPv4 network infrastructure.
Opmode	The Xilinx Opmode block generates a constant that is a DSP48A, DSP48, DS48E, or DSP48E1 instruction. The instruction is an 11-bit value for the DSP48, 8-bit for DSP48A, 15-bit value for the DSP48E and a 20-bit value for DSP48E1. The instruction can consists of the opmode, carry-in, carry-in select, inmode and either the subtract or alumode bits (depending upon the selection of DSP48 or DSP48E type).
Parallel to Serial	The Parallel to Serial block takes an input word and splits it into N time-multiplexed output words where N is the ratio of number of input bits to output bits. The order of the output can be either least significant bit first or most significant bit first.

Table 1-8: Index Blocks

Index Block	Description
Pause Simulation	The Xilinx Pause Simulation block pauses the simulation when the input is non-zero. The block accepts any Xilinx signal type as input.
PicoBlaze Instruction Display	The PicoBlaze Instruction Display block takes an encoded 18-bit PicoBlaze instruction and a 10 bit address and displays the decoded instruction and the program counter on the block icon. This feature is useful when debugging PicoBlaze designs and can be used in conjunction with the Single-Step Simulation block to step through each instruction.
PicoBlaze Microcontroller	The Xilinx PicoBlaze Microcontroller block implements an embedded 8-bit microcontroller using the PicoBlaze macro.
PicoBlaze6 Instruction Display	The PicoBlaze6™ Instruction Display block takes an encoded 18-bit picoblaze6 instruction and PicoBlaze address output and displays the decoded instruction and the program counter on the block icon. This feature is useful when debugging PicoBlaze6 designs and can be used in conjunction with the Single-Step Simulation block to step through each instruction.
PicoBlaze6 Microcontroller	The Xilinx PicoBlaze6™ Microcontroller block implements an 8-bit microcontroller.
Point-to-point Ethernet Co-Simulation	The Xilinx Point-to-point Ethernet Co-Simulation block provides an interface to perform hardware co-simulation through a raw Ethernet connection.
Puncture	The Xilinx Puncture block removes a set of user-specified bits from the input words of its data stream.
Reciprocal	The Xilinx Reciprocal block performs the reciprocal on the input. Currently, only the floating-point data type is supported.
Reciprocal SquareRoot	The Xilinx Reciprocal SquareRoot block performs the reciprocal squareroot on the input. Currently, only the floating-point data type is supported.
Reed-Solomon Decoder 7.1	The Reed-Solomon (RS) codes are block-based error correcting codes with a wide range of applications in digital communications and storage.
Reed-Solomon Decoder 8.0	The Reed-Solomon (RS) codes are block-based error correcting codes with a wide range of applications in digital communications and storage.
Reed-Solomon Encoder 7.1	The Reed-Solomon (RS) codes are block-based error correcting codes with a wide range of applications in digital communications and storage.
Reed-Solomon Encoder 8.0	The Reed-Solomon (RS) codes are block-based error correcting codes with a wide range of applications in digital communications and storage. This block adheres to the AMBA® AXI4-Stream standard.
Reciprocal	The Xilinx Reciprocal block performs the reciprocal on the input. Currently, only the floating-point data type is supported.
Register	The Xilinx Register block models a D flip-flop-based register, having latency of one sample period.
Reinterpret	The Xilinx Reinterpret block forces its output to a new type without any regard for retaining the numerical value represented by the input.
Relational	The Xilinx Relational block implements a comparator.

**Table 1-8: Index Blocks**

<b>Index Block</b>	<b>Description</b>
Reset Generator	The Reset Generator block captures the user's reset signal that is running at the system sample rate, and produces one or more downsampled reset signal(s) running at the rates specified on the block.
Resource Estimator	The Xilinx Resource Estimator block provides fast estimates of FPGA resources required to implement a System Generator subsystem or model.
ROM	The Xilinx ROM block is a single port read-only memory (ROM).
Sample Time	The Sample Time block reports the normalized sample period of its input. A signal's normalized sample period is not equivalent to its Simulink absolute sample period. In hardware, this block is implemented as a constant.
Scale	The Xilinx Scale block scales its input by a power of two. The power can be either positive or negative. The block has one input and one output. The scale operation has the effect of moving the binary point without changing the bits in the container
Serial to Parallel	The Serial to Parallel block takes a series of inputs of any size and creates a single output of a specified multiple of that size. The input series can be ordered either with the most significant word first or the least significant word first.
Shared Memory	The Xilinx Shared Memory block implements a random access memory (RAM) that can be shared among multiple designs or sections of a design.
Shared Memory Read	The Xilinx Shared Memory Read block provides a high-speed interface for reading data from a Xilinx shared memory object. Both FIFO and lockable shared memory objects are supported by the block.
Shared Memory Write	The Xilinx Shared Memory Write block provides a high-speed interface for writing data into a Xilinx shared memory object. Both FIFO and lockable shared memory objects are supported by the block.
Shift	The Xilinx Shift block performs a left or right shift on the input signal. The result will have the same fixed-point container as that of the input.
Simulation Multiplexer	The Simulation Multiplexer has been deprecated in System Generator.
Single Port RAM	The Xilinx Single Port RAM block implements a random access memory (RAM) with one data input and one data output port.
Single-Step Simulation	The Xilinx Single-Step Simulation block pauses the simulation each clock cycle when in single-step mode.
Slice	The Xilinx Slice block allows you to slice off a sequence of bits from your input data and create a new data value. This value is presented as the output from the block. The output data type is unsigned with its binary point at zero.
SquareRoot	The Xilinx SquareRoot block performs the square root on the input. Currently, only the floating-point data type is supported.

Table 1-8: Index Blocks

Index Block	Description
System Generator	The System Generator token serves as a control panel for controlling system and simulation parameters, and it is also used to invoke the code generator for netlisting. Every Simulink model containing any element from the Xilinx Blockset must contain at least one System Generator token. Once a System Generator token is added to a model, it is possible to specify how code generation and simulation should be handled.
Threshold	The Xilinx Threshold block tests the sign of the input number. If the input number is negative, the output of the block is -1; otherwise, the output is 1. The output is a signed fixed-point integer that is 2 bits long. The block has one input and one output.
Time Division Demultiplexer	The Xilinx Time Division Demultiplexer block accepts input serially and presents it to multiple outputs at a slower rate.
Time Division Multiplexer	The Xilinx Time Division Multiplexer block multiplexes values presented at input ports into a single faster rate output stream.
To FIFO	The Xilinx To FIFO block implements the leading half of a first-in-first-out memory queue.
To Register	The Xilinx To Register block implements the leading half of a D flip-flop based register, having latency of one sample period. The register can be shared among multiple designs or sections of a design.
Toolbar	The Xilinx Toolbar block provides quick access to several useful utilities in System Generator. The Toolbar simplifies the use of the zoom feature in Simulink and adds new auto layout and route capabilities to Simulink models.
Up Sample	The Xilinx Up Sample block increases the sample rate at the point where the block is placed in your design. The output sample period is $l/n$ , where $l$ is the input sample period and $n$ is the sampling rate.
VDMA Interface 4.0	The VDMA (Video Direct Memory Access) Interface block is a bit-accurate simulation model containing up to 4 AXI VDMA IP LogiCOREs connected to an AXI interconnect and external memory.
Viterbi Decoder 7.0	Data encoded with a convolution encoder can be decoded using the Xilinx Viterbi decoder block.
Viterbi Decoder 8.0	Data encoded with a convolution encoder can be decoded using the Xilinx Viterbi decoder block. This block adheres to the AMBA® AXI4-Stream standard.
WaveScope	The System Generator WaveScope block provides a powerful and easy-to-use waveform viewer for analyzing and debugging System Generator designs.



## Math Blocks

Table 1-9: Math Blocks

Math Block	Description
Absolute	The Xilinx Absolute block outputs the absolute value of the input.
Accumulator	The Xilinx Accumulator block implements an adder or subtractor-based scaling accumulator.
AddSub	The Xilinx AddSub block implements an adder/subtractor. The operation can be fixed (Addition or Subtraction) or changed dynamically under control of the sub mode signal.
CMult	The Xilinx CMult block implements a gain operator, with output equal to the product of its input by a constant value. This value can be a MATLAB expression that evaluates to a constant.
Complex Multiplier 3.1	The Xilinx Complex Multiplier block multiplies two complex numbers.
Complex Multiplier 5.0	The Complex Multiplier 5.0 block implements AXI4-Stream compliant, high-performance, optimized complex multipliers for Virtex-6 and Spartan-6 devices based on user-specified options.
Constant	The Xilinx Constant block generates a constant that can be a fixed-point value, a Boolean value, or a DSP48 instruction. This block is similar to the Simulink constant block, but can be used to directly drive the inputs on Xilinx blocks.
Convert	The Xilinx Convert block converts each input sample to a number of a desired arithmetic type. For example, a number can be converted to a signed (two's complement) or unsigned value.
CORDIC 4.0	The Xilinx CORDIC 4.0 block implements a generalized coordinate rotational digital computer (CORDIC) algorithm.
CORDIC 5.0	The Xilinx CORDIC 5.0 block implements a generalized coordinate rotational digital computer (CORDIC) algorithm and is AXI compliant.
Counter	The Xilinx Counter block implements a free running or count-limited type of an up, down, or up/down counter. The counter output can be specified as a signed or unsigned fixed-point number.
Divide	The Xilinx Divide block performs both fixed-point and floating-point division with the a input being the dividend and the b input the divisor. Both inputs must be of the same data type.
Divider Generator 3.0	The Xilinx Divider Generator 3.0 block creates a circuit for integer division based on Radix-2 non-restoring division, or High-Radix division with prescaling.
Divider Generator 4.0	The Xilinx Divider Generator 4.0 block creates a circuit for integer division based on Radix-2 non-restoring division, or High-Radix division with prescaling.
Expression	The Xilinx Expression block performs a bitwise logical expression.
Inverter	The Xilinx Inverter block calculates the bitwise logical complement of a fixed-point number. The block is implemented as a synthesizable VHDL module.

Table 1-9: Math Blocks

Math Block	Description
Logical	The Xilinx Logical block performs bitwise logical operations on fixed-point numbers. Operands are zero padded and sign extended as necessary to make binary point positions coincide; then the logical operation is performed and the result is delivered at the output port.
MCode	The Xilinx MCode block is a container for executing a user-supplied MATLAB function within Simulink. A parameter on the block specifies the M-function name. The block executes the M-code to calculate block outputs during a Simulink simulation. The same code is translated in a straightforward way into equivalent behavioral VHDL/Verilog when hardware is generated.
Mult	The Xilinx Mult block implements a multiplier. It computes the product of the data on its two input ports, producing the result on its output port.
Natural Logarithm	The Xilinx Natural Logarithm block produces the natural logarithm of the input.
Negate	The Xilinx Negate block computes the arithmetic negation of its input.
Reciprocal	The Xilinx Reciprocal block performs the reciprocal on the input. Currently, only the floating-point data type is supported.
Reciprocal SquareRoot	The Xilinx Reciprocal SquareRoot block performs the reciprocal squareroot on the input. Currently, only the floating-point data type is supported.
Reinterpret	The Xilinx Reinterpret block forces its output to a new type without any regard for retaining the numerical value represented by the input.
Relational	The Xilinx Relational block implements a comparator.
Scale	The Xilinx Scale block scales its input by a power of two. The power can be either positive or negative. The block has one input and one output. The scale operation has the effect of moving the binary point without changing the bits in the container
Shift	The Xilinx Shift block performs a left or right shift on the input signal. The result will have the same fixed-point container as that of the input.
SquareRoot	The Xilinx SquareRoot block performs the square root on the input. Currently, only the floating-point data type is supported.
Threshold	The Xilinx Threshold block tests the sign of the input number. If the input number is negative, the output of the block is -1; otherwise, the output is 1. The output is a signed fixed-point integer that is 2 bits long. The block has one input and one output.

## Memory Blocks

Table 1-10: Memory Blocks

Math Block	Description
Addressable Shift Register	The Xilinx Addressable Shift Register block is a variable-length shift register in which any register in the delay chain can be addressed and driven onto the output data port.
AXI FIFO	The Xilinx AXI FIFO block implements a FIFO memory queue with an AXI-compatible block interface.
Delay	The Xilinx Delay block implements a fixed delay of L cycles.
Dual Port RAM	The Xilinx Dual Port RAM block implements a random access memory (RAM). Dual ports enable simultaneous access to the memory space at different sample rates using multiple data widths.
FIFO	The Xilinx FIFO block implements an FIFO memory queue.
LFSR	The Xilinx LFSR block implements a Linear Feedback Shift Register (LFSR). This block supports both the Galois and Fibonacci structures using either the XOR or XNOR gate and allows a re-loadable input to change the current value of the register at any time. The LFSR output and re-loadable input can be configured as either serial or parallel ports
Register	The Xilinx Register block models a D flip-flop-based register, having latency of one sample period.
ROM	The Xilinx ROM block is a single port read-only memory (ROM).
Shared Memory	The Xilinx Shared Memory block implements a random access memory (RAM) that can be shared among multiple designs or sections of a design.
Single Port RAM	The Xilinx Single Port RAM block implements a random access memory (RAM) with one data input and one data output port.
VDMA Interface 4.0	The VDMA (Video Direct Memory Access) Interface block is a bit-accurate simulation model containing up to 4 AXI VDMA IP LogiCOREs connected to an AXI interconnect and external memory.
VDMA Interface 5.4	As shown in the illustration below, the VDMA Interface block's AXI memory-mapped interface is connected to the AXI Interconnect. DDR external memory is connected as the only slave on the AXI Interconnect. All ports except memory-mapped ports of the VDMA block are available on the VDMA Interface block.

## Shared Memory Blocks

Table 1-11: Shared Memory Blocks

Shared Memory Block	Description
From FIFO	The Xilinx From FIFO block implements the trailing half of a first-in-first-out memory queue.
From Register	The Xilinx From Register block implements the trailing half of a D flip-flop based register. The physical register can be shared among two designs or two portions of the same design.
Multiple Subsystem Generator	The Xilinx Multiple Subsystem Generator block wires two or more System Generator designs into a single top-level HDL component that incorporates multiple clock domains. This top-level component includes the logic associated with each System Generator design and additional logic to allow the designs to communicate with one another.
Shared Memory	The Xilinx Shared Memory block implements a random access memory (RAM) that can be shared among multiple designs or sections of a design.
Shared Memory Read	The Xilinx Shared Memory Read block provides a high-speed interface for reading data from a Xilinx shared memory object. Both FIFO and lockable shared memory objects are supported by the block.
Shared Memory Write	The Xilinx Shared Memory Write block provides a high-speed interface for writing data into a Xilinx shared memory object. Both FIFO and lockable shared memory objects are supported by the block.
To FIFO	The Xilinx To FIFO block implements the leading half of a first-in-first-out memory queue.
To Register	The Xilinx To Register block implements the leading half of a D flip-flop based register, having latency of one sample period. The register can be shared among multiple designs or sections of a design.

## Tool Blocks

Table 1-12: Tool Blocks

Tool Blocks	Description
ChipScope	The Xilinx ChipScope™ block enables run-time debugging and verification of signals within an FPGA.
Clock Probe	The Xilinx Clock Probe generates a double-precision representation of a clock signal with a period equal to the Simulink system period.
Configurable Subsystem Manager	The Xilinx Configurable Subsystem Manager extends Simulink's configurable subsystem capabilities to allow a subsystem configurations to be selected for hardware generation as well as for simulation.
FDATool	The Xilinx FDATool block provides an interface to the FDATool software available as part of the MATLAB Signal Processing Toolbox.

**Table 1-12: Tool Blocks**

<b>Tool Blocks</b>	<b>Description</b>
Indeterminate Probe	The output of the Xilinx Indeterminate Probe indicates whether the input data is indeterminate (MATLAB value NaN). An indeterminate data value corresponds to a VHDL indeterminate logic data value of 'X'.
ModelSim	The System Generator Black Box block provides a way to incorporate existing HDL files into a model. When the model is simulated, co-simulation can be used to allow black boxes to participate. The ModelSim HDL co-simulation block configures and controls co-simulation for one or several black boxes.
Multiple Subsystem Generator	The Xilinx Multiple Subsystem Generator block wires two or more System Generator designs into a single top-level HDL component that incorporates multiple clock domains. This top-level component includes the logic associated with each System Generator design and additional logic to allow the designs to communicate with one another.
Pause Simulation	The Xilinx Pause Simulation block pauses the simulation when the input is non-zero. The block accepts any Xilinx signal type as input.
PicoBlaze Microcontroller	The Xilinx PicoBlaze Microcontroller block implements an embedded 8-bit microcontroller using the PicoBlaze macro.
PicoBlaze6 Microcontroller	The PicoBlaze6™ Instruction Display block takes an encoded 18-bit picoblaze6 instruction and PicoBlaze address output and displays the decoded instruction and the program counter on the block icon. This feature is useful when debugging PicoBlaze6 designs and can be used in conjunction with the Single-Step Simulation block to step through each instruction.
Resource Estimator	The Xilinx Resource Estimator block provides fast estimates of FPGA resources required to implement a System Generator subsystem or model.
Sample Time	The Sample Time block reports the normalized sample period of its input. A signal's normalized sample period is not equivalent to its Simulink absolute sample period. In hardware, this block is implemented as a constant.
Simulation Multiplexer	The Simulation Multiplexer has been deprecated in System Generator.
Single-Step Simulation	The Xilinx Single-Step Simulation block pauses the simulation each clock cycle when in single-step mode.
System Generator	The System Generator token serves as a control panel for controlling system and simulation parameters, and it is also used to invoke the code generator for netlisting. Every Simulink model containing any element from the Xilinx Blockset must contain at least one System Generator token. Once a System Generator token is added to a model, it is possible to specify how code generation and simulation should be handled.
Toolbar	The Xilinx Toolbar block provides quick access to several useful utilities in System Generator. The Toolbar simplifies the use of the zoom feature in Simulink and adds new auto layout and route capabilities to Simulink models.
WaveScope	The System Generator WaveScope block provides a powerful and easy-to-use waveform viewer for analyzing and debugging System Generator designs.

## Simulink Blocks Supported by System Generator

In general, Simulink blocks can be included in a Xilinx design for simulation purposes, but will not be mapped to Xilinx hardware. However, the following Simulink blocks are fully supported by System Generator and is mapped to Xilinx hardware:

*Table 1-13: Simulink Blocks Supported by System Generator*

Simulink Block	Description
Demux	The Demux block extracts the components of an input signal and outputs the components as separate signals.
From	The From block accepts a signal from a corresponding Goto block, then passes it as output.
Goto	The Goto block passes its input to its corresponding From blocks.
Mux	The Mux block combines its inputs into a single vector output.

Refer to the corresponding Simulink documentation for a complete description of the block.

## Common Options in Block Parameter Dialog Boxes

Each Xilinx block has several controls and configurable parameters, seen in its block parameters dialog box. This dialog box can be accessed by double-clicking on the block. Many of these parameters are specific to the block. Block-specific parameters are described in the documentation for the block.

The remaining controls and parameters are common to most blocks. These common controls and parameters are described below.

Each dialog box contains four buttons: **OK**, **Cancel**, **Help**, and **Apply**. **Apply** applies configuration changes to the block, leaving the box open on the screen. **Help** displays HTML help for the block. **Cancel** closes the box without saving changes. **OK** applies changes and closes the box.

### Avoid Naming Your Design the Same as a Xilinx Block

It is important that you don't name your design the same as a Xilinx block. For example, if you name your design **shared\_memory.mdl**, it may cause System Generator to issue an error message.

### Precision

The fundamental computational mode in the Xilinx blockset is arbitrary precision fixed-point arithmetic. Most blocks give you the option of choosing the precision, for example, the number of bits and binary point position.

By default, the output of Xilinx blocks is *full* precision; that is, sufficient precision to represent the result without error. Most blocks have a *User-Defined* precision option that fixes the number of total and fractional bits

### Arithmetic Type

In the **Type** field of the block parameters dialog box, you can choose unsigned or signed (two's complement) as the data type of the output signal.

### Number of Bits

Fixed-point numbers are stored in data types characterized by their word size as specified by number of bits, binary point, and arithmetic type parameters. The maximum number of bits supported is 4096.

### Binary Point

The binary point is the means by which fixed-point numbers are scaled. The binary point parameter indicates the number of bits to the right of the binary point (for example, the size of the fraction) for the output port. The binary point position must be between zero and the specified number of bits.

### Overflow and Quantization

When user-defined precision is selected, errors can result from overflow or quantization. Overflow errors occur when a value lies outside the representable range. Quantization errors occur when the number of fractional bits is insufficient to represent the fractional portion of a value.

The Xilinx fixed-point data type supports several options for user-defined precision. For overflow the options are to **Saturate** to the largest positive/smallest negative value, to **Wrap** (for example, to discard bits to the left of the most significant representable bit), or to **Flag as error** (an overflow as

a Simulink error) during simulation. **Flag as error** is a simulation only feature. The hardware generated is the same as when **Wrap** is selected.

For quantization, the options are to **Round** to the nearest representable value (or to the value furthest from zero if there are two equidistant nearest representable values), or to **Truncate** (for example, to discard bits to the right of the least significant representable bit).

The following is an image showing the Quantization and Overflow options.

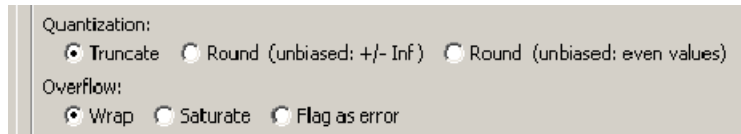

**Round(unbiased: +/- inf)** also known as "Symmetric Round (towards +/- inf)" or "Symmetric Round (away from zero)". This is similar to the Matlab round() function. This method rounds the value to the nearest desired bit away from zero and when there is a value at the midpoint between two possible rounded values, the one with the larger magnitude is selected. For example, to round 01.0110 to a Fix\_4\_2, this yields 01.10, since 01.0110 is exactly between 01.01 and 01.10 and the latter is further from zero.

**Round (unbiased: even values)** also known as "Convergent Round (toward even)" or "Unbiased Rounding". Symmetric rounding is biased because it rounds all ambiguous midpoints away from zero which means the average magnitude of the rounded results is larger than the average magnitude of the raw results. Convergent rounding removes this by alternating between a symmetric round toward zero and symmetric round away from zero. That is, midpoints are rounded toward the nearest even number. For example, to round 01.0110 to a Fix\_4\_2, this yields 01.10, since 01.0110 is exactly between 01.01 and 01.10 and the latter is even. To round 01.1010 to a Fix\_4\_2, this yields 01.10, since 01.1010 is exactly between 01.10 and 01.11 and the former is even.

It is important to realize that whatever option is selected, the generated HDL model and Simulink model behave identically.

## Latency

Many elements in the Xilinx blockset have a latency option. This defines the number of sample periods by which the block's output is delayed. One sample period might correspond to multiple clock cycles in the corresponding FPGA implementation (for example, when the hardware is over-clocked with respect to the Simulink model). System Generator does not perform extensive pipelining; additional latency is usually implemented as a shift register on the output of the block.

## Provide Synchronous Reset Port

Selecting the **Provide Synchronous Reset Port** option activates an optional reset (rst) pin on the block.

When the reset signal is asserted the block goes back to its initial state. Reset signal has precedence over the optional enable signal available on the block. The reset signal has to run at a multiple of the block's sample rate. The signal driving the reset port must be Boolean.

## Provide Enable Port

Selecting the **Provide Enable Port** option activates an optional enable (en) pin on the block. When the enable signal is not asserted the block holds its current state until the enable signal is asserted again or the reset signal is asserted. Reset signal has precedence over the enable signal. The enable



signal has to run at a multiple of the block's sample rate. The signal driving the enable port must be Boolean.

## Sample Period

Data streams are processed at a specific sample rate as they flow through Simulink. Typically, each block detects the input sample rate and produces the correct sample rate on its output. Xilinx blocks Up Sample and Down Sample provide a means to increase or decrease sample rates.

### Specify Explicit Sample Period

If you select **Specify explicit sample period** rather than the default, you can set the sample period required for all the block outputs. This is useful when implementing features such as feedback loops in your design. In a feedback loop, it is not possible for System Generator to determine a default sample rate, because the loop makes an input sample rate depend on a yet-to-be-determined output sample rate. System Generator under these circumstances requires you to supply a hint to establish sample periods throughout a loop.

### Use Behavioral HDL (otherwise use core)

When this checkbox is checked, the behavioral HDL generated by the M-code simulation is used instead of the structural HDL from the cores.

The M-code simulation creates the C simulation and this C simulation creates behavioral HDL. When this option is selected, it is this behavioral HDL that is used for further synthesis. When this option is not selected, the structural HDL generated from the cores and HDL templates (corresponding to each of the blocks in the model) is used instead for synthesis. Cores are generated for each block in a design once and cached for future netlisting. This capability ensures the fastest possible netlist generation while guaranteeing that the cores are available for downstream synthesis and place and route tools.

### Use XtremeDSP Slice

This field specifies that if possible, use the XtremeDSP slice (DSP48 type element) in the target device. Otherwise, CLB logic are used for the multipliers.

### FPGA Area (Slices, FFs, LUTs, IOBs, Embedded Mults, TBUFs) / Use Area Above For Estimation

These fields are used by the [Resource Estimator](#) block. The Resource Estimator gives you the ability to calculate the hardware resources needed for your System Generator design.

If you have placed a Resource Estimator in your design, you can use the **FPGA Area** field to manually enter the FPGA area utilization of a specific block. If you do not fill in these values, the Resource Estimator will calculate and fill in these values automatically.

If you wish to manually enter your own values for a specific block, then you must check the **Define FPGA area for resource estimation** box in order to force the Resource Estimator to use your entered values. Otherwise, the Resource Estimator will recalculate the FPGA Area and overwrite any values that you have entered into this field.

There are seven values available to enter into the FPGA Area field. You must enter or read each value in its correct position. If 'value=[1,2,3,4,5,6,7];' then:

- value(1) = Slices utilized by the block. An FPGA slice usually consists of two flip-flops, two LUTs and some associated mux, carry, and control logic.
- value(2) = Flip-Flops utilized by the block.
- value(3) = Block RAM (BRAMs) utilized by the block.
- value(4) = LUTs utilized by the block.
- value(5) = IOBs consumed by the block.
- value(6) = Embedded (Emb.) multipliers utilized by the block.
- value(7) = Tristate Buffers (TBUFs) utilized by the block.

Only the Xilinx blocks that have a hardware cost (for example, blocks that require physical hardware resources) are considered by the Resource Estimator. The FPGA Area field is omitted from blocks with no associated hardware.

Although Slices are related to LUTs and Flops (Each Slice contains 1 LUT and 1 Flip-Flop), they are entered separately since the number of packed slices will vary depending on the particular design.

Some Xilinx blocks do not support automatic resource estimation, as indicated in the Resource Estimator block documentation. The FPGA Area field for these blocks will not be updated automatically, and attempting to do so will cause a warning message to be displayed in the MATLAB console.

## Display shortened port names

AXI4-Stream signal names have been shortened (by default) to improve readability on the block. Name shortening is purely cosmetic and when netlisting occurs, the full AXI4-Stream name is used. For example, a shortened master signal on an AXI4-Stream interface might be `data_tvalid`. When **Display shortened port names** is unchecked, the name becomes `m_axis_data_tvalid`.

## Block Reference Pages

## Absolute

This block is listed in the following Xilinx Blockset libraries: *Math, Floating-Point, Basic Elements and Index.*

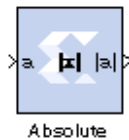

The Xilinx Absolute block outputs the absolute value of the input.

### Block Parameters

The block parameters dialog box can be invoked by double-clicking the icon in your Simulink model.

#### Basic tab

##### Precision:

This parameter allows you to specify the output precision for fixed-point arithmetic. Floating point arithmetic output will always be **Full** precision.

- **Full:** The block uses sufficient precision to represent the result without error.
- **User Defined:** If you don't need full precision, this option allows you to specify a reduced number of total bits and/or fractional bits.

##### Fixed-point Output Type

###### Arithmetic type:

- ◆ **Signed (2's comp):** The output is a Signed (2's complement) number.
- ◆ **Unsigned:** The output is an Unsigned number.

###### Fixed-point Precision

- ◆ **Number of bits:** specifies the bit location of the binary point of the output number, where bit zero is the least significant bit.
- ◆ **Binary point:** position of the binary point. in the fixed-point output

###### Quantization

Refer to the section [Overflow and Quantization](#).

###### Overflow

Refer to the section [Overflow and Quantization](#).

Other parameters used by this block are explained in the topic [Common Options in Block Parameter Dialog Boxes](#).

### LogiCORE™ Documentation

[LogiCORE IP Floating-Point Operator v6.1](#)

## Device Support

Floating-Point support is restricted to the following devices:

Virtex®-7, Kintex™-7, Artix™-7, Zynq™-7000, Virtex-6, Spartan®-6

## Accumulator

This block is listed in the following Xilinx Blockset libraries: *Math and Index*.

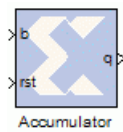

The Xilinx Accumulator block implements an adder or subtractor-based scaling accumulator.

The block's current input is accumulated with a scaled current stored value. The scale factor is a block parameter.

### Block Interface

The block has an input  $b$  and an output  $q$ . The output must have the same width as the input data. The output will have the same arithmetic type and binary point position as the input. The output  $q$  is calculated as follows:

$$q(n) = \begin{cases} 0 & \text{if } rst=1 \\ q(n-1) \times FeedbackScaling + b(n-1) & \text{otherwise} \end{cases}$$

A subtractor-based accumulator replaces addition of the current input  $b(n)$  with subtraction.

### Block Parameters

The block parameters dialog box can be invoked by double-clicking the icon in your Simulink model.

#### Basic tab

Parameters specific to the Basic tab are as follows:

- **Operation:** This determines whether the block is adder- or subtractor-based.
- **Feedback scaling:** specifies the feedback scale factor to be one of the following: 1, 1/2, 1/4, 1/8, 1/16, 1/32, 1/64, 1/128, or 1/256.
- **Reinitialize with input 'b' on reset:** when selected, the output of the accumulator is reset to the data on input port  $b$ . When not selected, the output of the accumulator is reset to zero. This option is available only when the block has a reset port. Using this option has clock speed implications if the accumulator is in a multirate system. In this case the accumulator is forced to run at the system rate since the clock enable (CE) signal driving the accumulator runs at the system rate and the reset to input operation is a function of the CE signal.

#### Implementation tab

Parameters specific to the Implementation tab are as follows:

- **Use behavioral HDL (otherwise use core):** The block is implemented using behavioral HDL. This gives the downstream logic synthesis tool maximum freedom to optimize for performance or area.
- **Implement using:** Core logic can be implemented in **Fabric** or in a **DSP48**, if a DSP48 is available in the target device. The default is **Fabric**.

Other parameters used by this block are explained in the topic [Common Options in Block Parameter Dialog Boxes](#).

The Accumulator block always has a latency of 1.

## LogiCORE™ Documentation

[LogiCORE IP Accumulator v11.0](#)

## Device Support

Virtex-7, Kintex-7, Virtex-6, Virtex-5, Virtex-4, Spartan-6, Spartan-3/XA, Spartan-3E/XA,  
Spartan-3A/3AN/3A DSP/XA

## Addressable Shift Register

This block is listed in the following Xilinx Blockset libraries: *Basic Elements, Floating-Point, Memory and Index.*

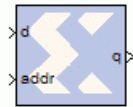

Addressable Shift Register

The Xilinx Addressable Shift Register block is a variable-length shift register in which any register in the delay chain can be addressed and driven onto the output data port.

The block operation is most easily thought of as a chain of registers, where each register output drives an input to a multiplexer, as shown below. The multiplexer select line is driven by the address port (`addr`). The output data port is shown below as `q`.

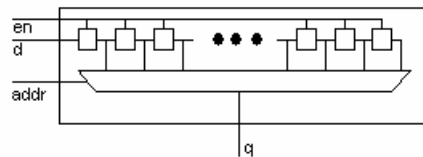

The Addressable Shift Register has a maximum depth of 1024 and a minimum depth of 2. The address input port, therefore, can be between 1 and 10 bits (inclusive). The data input port width must be between 1 and 255 bits (inclusive) when this block is implemented with the Xilinx LogiCORE™ (for example, when **Use behavioral HDL (otherwise use core)** is unchecked).

In hardware, the address port is asynchronous relative to the output port. In the block S-function, the address port is therefore given priority over the input data port, for example, on each successive cycle, the addressed data value is read from the register and driven to the output before the shift operation occurs. This order is needed in the Simulink software model to guarantee one clock cycle of latency between the data port and the first register of the delay chain. (If the shift operation were to come first, followed by the read, then there would be no delay, and the hardware would be incorrect.)

### Block Interface

The block interface (inputs and outputs as seen on the Addressable Shift Register icon) are as follows:

#### Input Signals:

<code>d</code>	data input
<code>addr</code>	address
<code>en</code>	enable signal (optional)

#### Output Signals:

<code>q</code>	data output
----------------	-------------



## Block Parameters

The block parameters dialog box can be invoked by double-clicking the icon in your Simulink model.

### Basic tab

Parameters specific to this block are as follows:

- **Infer maximum latency (depth) using address port width:** you can choose to allow the block to automatically determine the depth or maximum latency of the shift-register-based on the bit-width of the address port.
- **Maximum latency (depth):** in the case that the maximum latency is not inferred (previous option), the maximum latency can be set explicitly.
- **Initial value vector:** specifies the initial register values. When the vector is longer than the shift register depth, the vector's trailing elements are discarded. When the shift register is deeper than the vector length, the shift register's trailing registers are initialized to zero.

Other parameters used by this block are explained in the topic [Common Options in Block Parameter Dialog Boxes](#).

### Implementation tab

Parameters specific to this block are as follows:

- **Optimization:** you can choose to optimize for **Resource** (minimum area) or for **Speed** (maximum performance).

## LogiCORE™ Documentation

[LogiCORE IP RAM-based Shift Register v11.0](#)

[LogiCORE IP Floating-Point Operator v6.1](#)

## Device Support

Virtex-7, Kintex-7, Virtex-6, Virtex-5, Virtex-4, Spartan-6, Spartan-3/XA, Spartan-3E/XA, Spartan-3A/3AN/3A DSP/XA

Floating-Point support is restricted to the following devices:

Virtex-7, Kintex-7, Virtex-6, Spartan-6

## AddSub

This block is listed in the following Xilinx Blockset libraries: *Math, Floating-Point and Index*.

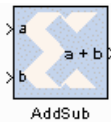

The Xilinx AddSub block implements an adder/subtractor. The operation can be fixed (Addition or Subtraction) or changed dynamically under control of the sub mode signal.

### Block Parameters

The block parameters dialog box can be invoked by double-clicking the icon in your Simulink model.

#### Basic tab

Parameters specific to the Basic tab are as follows:

- **Operation:** Specifies the block operation to be Addition, Subtraction, or Addition/Subtraction. When Addition/Subtraction is selected, the block operation is determined by the sub input port, which must be driven by a Boolean signal. When the sub input is 1, the block performs subtraction. Otherwise, it performs addition.
- **Provide carry-in port:** When selected, allows access to the carry-in port, `cin`. The carry-in port is available only when **User defined** precision is selected and the binary point of the inputs is set to zero.
- **Provide carry-out port:** When selected, allows access to the carry-out port, `cout`. The carry-out port is available only when **User defined** precision is selected, the inputs and output are unsigned, and the number of output integer bits equals `x`, where  $x = \max(\text{integer bits } a, \text{integer bits } b)$ .

#### Output tab

Precision:

This parameter allows you to specify the output precision for fixed-point arithmetic. Floating point arithmetic output will always be **Full** precision.

- **Full:** The block uses sufficient precision to represent the result without error.
- **User Defined:** If you don't need full precision, this option allows you to specify a reduced number of total bits and/or fractional bits.

#### User-Defined Precision

Fixed-point Precision

- ◆ **Signed (2's comp):** The output is a Signed (2's complement) number.
- ◆ **Unsigned:** The output is an Unsigned number.
- ◆ **Number of bits:** specifies the bit location of the binary point of the output number, where bit zero is the least significant bit.
- ◆ **Binary point:** position of the binary point. in the fixed-point output

Quantization

Refer to the section [Overflow and Quantization](#).

Overflow

Refer to the section [Overflow and Quantization](#).

## Implementation tab

Parameters specific to the Implementation tab are as follows:

- **Use behavioral HDL (otherwise use core):** The block is implemented using behavioral HDL. This gives the downstream logic synthesis tool maximum freedom to optimize for performance or area.

*Note:* For Floating-point operations, the block always uses the Floating-point Operator core.

Core Parameters

- **Pipeline for maximum performance:** The XILINX LogiCORE can be internally pipelined to optimize for speed instead of area. Selecting this option puts all user defined latency into the core until the maximum allowable latency is reached. If this option is not selected and latency is greater than zero, a single output register is put in the core and additional latency is added on the output of the core.
- **Implement using:** Core logic can be implemented in **Fabric** or in a **DSP48**, if a DSP48 is available in the target device. The default is **Fabric**.

Other parameters used by this block are explained in the topic [Common Options in Block Parameter Dialog Boxes](#).

## LogiCORE™ Documentation

[LogiCORE IP Adder/Subtractor v11.0](#)

[LogiCORE IP Floating-Point Operator v6.1](#)

## Device Support

Virtex-7, Kintex-7, Virtex-6, Virtex-5, Virtex-4, Spartan-6, Spartan-3/XA, Spartan-3E/XA, Spartan-3A/3AN/3A DSP/XA

Floating-Point support is restricted to the following devices:

Virtex-7, Kintex-7, Virtex-6, Spartan-6

## Assert

This block is listed in the following Xilinx Blockset libraries: *Floating-Point and Index*.

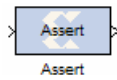

The Xilinx Assert block is used to assert a rate and/or a type on a signal. This block has no cost in hardware and can be used to resolve rates and/or types in situations where designer intervention is required.

### Block Parameters

The block parameters dialog box can be invoked by double-clicking the icon in your Simulink model.

Parameters specific to this block are as follows:

#### Assert Type

- **Assert type:** specifies whether or not the block will assert that the type at its input is the same as the type specified. If the types are not the same, an error message is reported.
- **Specify type:** specifies whether or not the type to assert is provided from a signal connected to an input port named `type` or whether it is specified **Explicitly** from parameters in the Assert block dialog box.

#### Output Precision

- Specifies the data type of the output. Can be **Boolean**, **Fixed-point**, or **Floating-point**.

**Arithmetic Type:** If the Output Type is specified as Fixed-point, you can select **Signed (2's comp)** or **Unsigned** as the Arithmetic Type.

##### Fixed-point Precision

- ◆ **Number of bits:** specifies the bit location of the binary point of the output number, where bit zero is the least significant bit.
- ◆ **Binary point:** position of the binary point. in the fixed-point output

##### Floating-point Precision

- **Single:** Specifies single precision (32 bits)
- **Double:** Specifies double precision (64 bits)
- **Custom:** Activates the field below so you can specify the Exponent width and the Fraction width.

**Exponent width:** Specify the exponent width.

**Fraction width:** Specify the fraction width.

#### Rate

- **Assert rate:** specifies whether or not the block will assert that the rate at its input is the same as the rate specified. If the rates are not the same, an error message is reported.
- **Specify rate:** specifies whether or not the initial rate to assert is provided from a signal connected to an input port named `rate` or whether it is specified **Explicitly** from the Sample rate parameter in the Assert block dialog box.
- **Provide output port:** specifies whether or not the block will feature an output port. The type and/or rate of the signal presented on the output port is the type and/or rate specified for assertion.

Other parameters used by this block are explained in the topic [Common Options in Block Parameter Dialog Boxes](#).

The **Output type** parameter in this block uses the same description as the Arithmetic Type described in the topic [Common Options in Block Parameter Dialog Boxes](#).

The Assert block does not use a Xilinx LogiCORE™ and does not use resources when implemented in hardware.

## Using the Assert block to Resolve Rates and Types

In cases where the simulation engine cannot resolve rates or types, the Assert block can be used to force a particular type or rate. In general this might be necessary when using components that use feedback and act as a signal source. For example, the circuit below requires an Assert block to force the rate and type of an SRL16. In this case, you can use an Assert block to 'seed' the rate which is then propagated back to the SRL16 input through the SRL16 and back to the Assert block. The design below fails with the following message when the Assert block is not used.

“The data types could not be established for the feedback paths through this block. You might need to add **Assert** blocks to instruct the system how to resolve types.

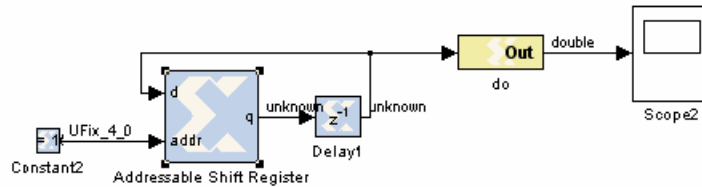

To resolve this error, an Assert block is introduced in the feedback path as shown below:

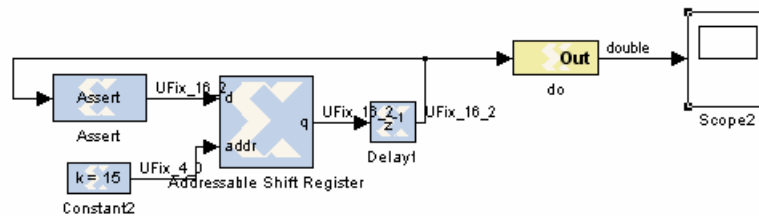

In the example, the Assert block is required to resolve the type, but the rate could have been determined by assigning a rate to the constant clock. The decision whether to use Constant blocks or Assert blocks to force rates is arbitrary and can be determined on a case by case basis.

System Generator 8.1 and later now resolves rates and types deterministically, however in some cases, the use of Assert blocks might be necessary for some System Generator components, even if they are resolvable. These blocks might include Black Box components and certain IP blocks.

## LogiCORE™ Documentation

[LogiCORE IP Floating-Point Operator v6.1](#)

## Device Support

Floating-Point support is restricted to the following devices:

Virtex-7, Kintex-7, Artix-7, Zynq-7000, Virtex-6, Spartan-6

## AXI FIFO

This block is listed in the following Xilinx Blockset libraries: Control Logic, Floating-Point, Memory, and Index.

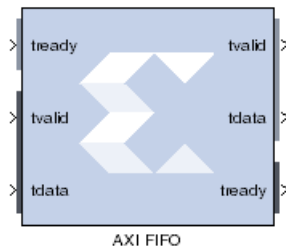

The Xilinx AXI FIFO block implements a FIFO memory queue with an AXI-compatible block interface.

### Block Interface

#### Write Channel

- **tready**: Indicates that the slave can accept a transfer in the current cycle.
- **tvalid**: Indicates that the master is driving a valid transfer. A transfer takes place when both tvalid and tready are asserted.
- **tdata**: The primary input data channel

#### Read Channel

- **tdata**: The primary output for the data.
- **tready**: Indicates that the slave can accept a transfer in the current cycle.

### Block Parameters

The block parameters dialog box can be invoked by double-clicking the icon in your Simulink model.

#### Basic tab

Parameters specific to the Basic tab are:

##### Performance Options:

- **FIFO depth**: specifies the number of words that can be stored. Range 16-4M.  
**Actual FIFO depth**: A report field that indicates the actual FIFO depth. The actual depth of the FIFO depends on its implementation and the features that influence its implementation.

##### Optional Ports:

- **TDATA**: The primary payload that is used to provide the data that is passing across the interface. The width of the data payload is an integer number of bytes.
- **TDEST**: Provides routing information for the data stream.
- **TSTRB**: The byte qualifier that indicates whether the content of the associated byte of TDATA is processed as a data byte or a position byte. For a 64-bit DATA, bit 0 corresponds to the least significant byte on DATA, and bit 7 corresponds to the most significant byte. For example:
  - ◆ STROBE[0] = 1b, DATA[7:0] is valid
  - ◆ STROBE[7] = 0b, DATA[63:56] is not valid

- **TREADY:** Indicates that the slave can accept a transfer in the current cycle.
- **TID:** The data stream identifier that indicates different streams of data.
- **TUSER:** The user-defined sideband information that can be transmitted alongside the data stream.
- **TKEEP:** The byte qualifier that indicates whether the content of the associated byte of TDATA is processed as part of the data stream. Associated bytes that have the TKEEP byte qualifier deasserted are null bytes and can be removed from the data stream. For a 64-bit DATA, bit 0 corresponds to the least significant byte on DATA, and bit 7 corresponds to the most significant byte. For example:
  - ◆ **KEEP[0] = 1b, DATA[7:0]** is a NULL byte
  - ◆ **KEEP [7] = 0b, DATA[63:56]** is not a NULL byte
- **TLAST:** Indicates the boundary of a packet.
- **arestn:** Adds arestn (global reset) port to the block.

#### Data Threshold Parameters

- **Provide FIFO occupancy DATA counts:** Adds data\_count port to the block. This port indicates the number of words written into the FIFO. The count is guaranteed to never underreport the number of words in the FIFO, to ensure the user never overflows the FIFO. The exception to this behavior is when a write operation occurs at the rising edge of write clock; that write operation will only be reflected on WR\_DATA\_COUNT at the next rising clock edge.  $D = \log_2(\text{FIFO depth}) + 1$

### Implementation tab

#### FIFO Options

- **FIFO implementation type:** specifies how the FIFO is implemented in the FPGA; possible choices are Common Clock Block RAM and Common Clock Distributed RAM.

Other parameters used by this block are explained in the topic [Common Options in Block Parameter Dialog Boxes](#).



## LogiCORE™ Documentation

[LogiCORE IP FIFO Generator 9.2](#)

[LogiCORE IP Floating-Point Operator v6.1](#)

## Device Support

Zynq-7000, Artix-7, Virtex-7, Kintex-7, Virtex-6, Virtex-5, Virtex-4, Spartan-6,  
Spartan-3A/3AN/3A DSP, Spartan-3E, Spartan-3

Floating-Point support is restricted to the following devices:

Zynq-7000, Artix-7, Virtex-7, Kintex-7, Virtex-6, Spartan-6

## BitBasher

This block is listed in the following Xilinx Blockset libraries: *Basic Elements, Data Types and Index.*

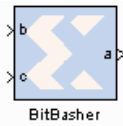

The Xilinx BitBasher block performs slicing, concatenation and augmentation of inputs attached to the block.

The operation to be performed is described using Verilog syntax which is detailed in this document. The block can have up to four output ports. The number of output ports is equal to the number of expressions. The block does not cost anything in hardware.

### Block Parameters

The block parameters dialog box can be invoked by double-clicking the icon in your Simulink model.

#### Basic tab

Parameters specific to the Basic tab are as follows:

- **BitBasher Expression:** Bitwise manipulation expression based on Verilog Syntax. Multiple expressions (limited to a maximum of 4) can be specified using new line as a separator between expressions.

#### Output Type tab

- **Output:** This refers to the port on which the data type is specified
- **Output type:** Arithmetic type to be forced onto the corresponding output
- **Binary Point:** Binary point location to be forced onto the corresponding output

Other parameters used by this block are explained in the topic [Common Options in Block Parameter Dialog Boxes.](#)

### Supported Verilog Constructs

The BitBasher block only supports a subset of Verilog expression constructs that perform bitwise manipulations including slice, concatenation and repeat operators. All specified expressions must adhere to the following template expression:

```
output_var = {bitbasher_expr}
```

**bitbasher\_expr:** A slice, concat or repeat expression based on Verilog syntax or simply an input port identifier.

**output\_var:** The output port identifier. An output port with the name output\_var will appear on the block and will hold the result of the wire expression bitbasher\_expr

#### Concat

```
output_var = {bitbasher_expr1, bitbasher_expr2, bitbasher_expr3}
```

The concat syntax is supported as shown above. Each of bitbasher\_exprN could either be an expression or simply an input port identifier.

The following are some examples of this construct:

```
a1 = {b, c, d, e, f, g}
a2 = {e}
a3 = {b, {f, c, d}, e}
```

## Slice

```
output_var = {port_identifier[bound1:bound2]}...(1)
output_var = {port_identifier[bitN]}...(2)
```

**port\_identifier:** The input port from which the bits are extracted.

**bound1, bound2:** Non-negative integers that lie between 0 and (bit-width of port\_identifier – 1)

**bitN:** Non-negative integers that lie between 0 and (bit-width of port\_identifier – 1)

As shown above, there are two schemes to extract bits from the input ports. If a range of consecutive bits need to be extracted, then the expression of the following form should be used.

```
output_var = {port_identifier[bound1:bound2]}...(1)
```

If only one bit is to be extracted, then the alternative form should be used.

```
output_var = {port_identifier[bitN]}...(2)
```

The following are some examples of this construct:

```
a1 = {b[7:3]}
```

a1 holds bits 7 through 3 of input b in the same order in which they appear in bit b (for example, if b is 110110110 then a1 is 10110).

```
a2 = {b[3:7]}
```

a2 holds bits 7 through 3 of input b in the reverse order in which they appear in bit b (for example, if b is 110100110 then a2 is 00101).

```
a3 = {b[5]}
```

a3 holds bit 5 of input b.

```
a4 = {b[7:5], c[3:9], {d, e}}
```

The above expression makes use of a combination of slice and concat constructs. Bits 7 through 5 of input b, bits 3 through 9 of input c and all the bits of d and e are concatenated.

## Repeat

```
output_var = {N{bitbasher_expr}}
```

**N:** A positive integer that represents the repeat factor in the expression

The following are some examples of this construct:

```
a1 = {4{b[7:3]}}
```

The above expression is equivalent to a1 = {b[7:3], b[7:3], b[7:3], b[7:3]}

```
a2 = {b[7:3], 2{c, d}}
```

The above expression is equivalent to a2 = {b[7:3], c, d, c, d }

## Constants

**Binary Constant:** N'bbin\_const

**Octal Constant:** N'ooctal\_const

**Decimal Constant:** N'doctal\_const

**Hexadecimal Constant:** N'hoctal\_const

**N:** A positive integer that represents the number of bits that are used to represent the constant

**bin\_const:** A legal binary number string made up of 0 and 1

**octal\_const:** A legal octal number string made up of 0, 1, 2, 3, 4, 5, 6 and 7

**decimal\_const:** A legal decimal number string made up of 0, 1, 2, 3, 4, 5, 6, 7, 8 and 9

**hexadecimal\_const:** A legal binary number string made up of 0, 1, 2, 3, 4, 5, 6, 7, 8, 9, a, b, c, d, e and f

A constant can only be used to augment expressions already derived from input ports. In other words, a BitBasher block cannot be used to simply source constant like the [Constant](#) block.

The following examples make use of this construct:

```
a1 = {4'b1100, e}
```

if e were 110110110 then a1 would be 1100110110110.

```
a1 = {4'hb, e}
```

if e were 110110110 then a1 would be 1101110110110.

```
a1 = {4'o10, e}
```

if e were 110110110 then a1 would be 1000110110110.

## Limitations

- Does not support masked parameterization on the bitbasher expressions.
- An expression cannot contain only constants, that is, each expression must include at least one input port.

## Black Box

This block is listed in the following Xilinx Blockset libraries: *Basic Elements*, *Control Logic*, *Floating-Point* and *Index*.

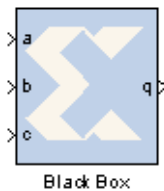

The System Generator Black Box block provides a way to incorporate hardware description language (HDL) models into System Generator.

The block is used to specify both the simulation behavior in Simulink and the implementation files to be used during code generation with System Generator. A black box's ports produce and consume the same sorts of signals as other System Generator blocks. When a black box is translated into hardware, the associated HDL entity is automatically incorporated and wired to other blocks in the resulting design.

The black box can be used to incorporate either VHDL or Verilog into a Simulink model. Black box HDL can be co-simulated with Simulink using the System Generator interface to either ISE® Simulator or the ModelSim simulation software from Model Technology, Inc. You can find more information on this topic in the documentation for the [ModelSim](#) block and in the topic [HDL Co-Simulation](#).

In addition to incorporating HDL into a System Generator model, the black box can be used to define the implementation associated with an external simulation model (e.g., [Hardware Co-Simulation Blocks](#)). System Generator also includes several Black Box Examples that demonstrate the capabilities and use of the black box.

### Requirements on HDL for Black Boxes

Every HDL component associated with a black box must adhere to the following System Generator requirements and conventions:

- The entity name must not collide with any entity name that is reserved by System Generator (e.g., `xfir`, `xregister`).
- Bi-directional ports are supported in HDL black boxes; however they will not be displayed in the System Generator as ports, they will only appear in the generated HDL after netlisting. Please refer to the topic for more information.
- For a Verilog Black Box, the module and port names must be lower case and follow standard Verilog naming conventions.
- For a VHDL Black Box, the supported port data types are `std_logic` and `std_logic_vector`.
- Top level ports should be ordered most significant bit down to least significant bit, as in `std_logic_vector(7 downto 0)`, and not `std_logic_vector(0 to 7)`.
- Clock and clock enable ports must be named according to the conventions described below.
- Any port that is a clock or clock enable must be of type `std_logic`. (For Verilog black boxes, such ports must be non-vector inputs, e.g., `input clk`.)
- Clock and clock enable ports on a black box are not treated like other ports. When a black box is translated into hardware, System Generator drives the clock and clock enable ports with signals whose rates can be specified according to the block's configuration and the sample rates that drive it in Simulink.
- Falling-edge triggered output data cannot be used.

To understand how clocks work for black boxes, it helps to understand how System Generator handles [Timing and Clocking](#) in general. To produce multiple rates in hardware, System Generator uses a single clock along with multiple clock enables, one enable for each rate. The enables activate different portions of hardware at the appropriate times. Each clock enable rate is related to a

corresponding sample period in Simulink. Every System Generator block that requires a clock has at least one clock and clock enable port in its HDL counterpart. Blocks having multiple rates have additional clock and clock enable ports.

Clocks for black boxes work like those for other System Generator blocks. The black box HDL must have a separate clock and clock enable port for each associated sample rate in Simulink. Clock and clock enable ports in black box HDL should be expressed as follows:

- Clock and clock enables must appear as pairs (for example, for every clock, there is a corresponding clock enable, and vice-versa). Although a black box can have more than one clock port, a single clock source is used to drive each clock port. Only the clock enable rates differ.
- Each clock name (respectively, clock enable name) must contain the substring `clk` (resp., `ce`).
- The name of a clock enable must be the same as that for the corresponding clock, but with `ce` substituted for `clk`. For example, if the clock is named `src_clk_1`, then the clock enable must be named `src_ce_1`.

Clock and clock enable ports are not visible on the black box block icon. A work around is required to make the top-level HDL clock enable port visible in System Generator; the work around is to add a separate enable port to the top-level HDL and AND this signal with the actual clock enable signal.

## The Black Box Configuration Wizard

The Configuration Wizard is a tool that makes it easy to associate a Verilog or VHDL component to a black box. The wizard is invoked whenever a black box is added to a model. To use the wizard, copy the file that defines the HDL component for a black box into the directory that contains the model. When a new black box is added to a model, the Configuration Wizard opens automatically. An example is shown in the figure below.

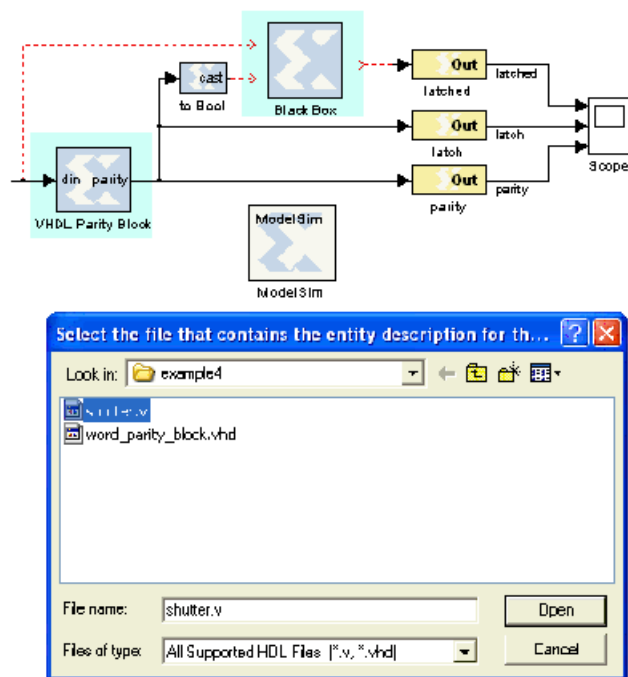

From this wizard choose the HDL file that should be associated to the black box, then press the **Open** button. The wizard generates a configuration M-function (described below) for the black box, and associates the function with the block. The configuration M-function produced by the wizard

can usually be used without change, but occasionally the function must be tailored by hand. Whether the configuration M-function needs to be modified depends on how complex the HDL is.

## The Black Box Configuration M-Function

A black box must describe its interface (e.g., ports and generics) and its implementation to System Generator. It does this through the definition of a MATLAB M-function (or p-function) called the block's configuration . The name of this function must be specified in the block parameter dialog box under the Block Configuration parameter.

The configuration M-function does the following:

- It specifies the top-level entity name of the HDL component that should be associated with the black box;
- It selects the language (for example, VHDL or Verilog);
- It describes ports, including type, direction, bit width, binary point position, name, and sample rate. Ports can be static or dynamic. Static ports do not change; dynamic ports change in response to changes in the design. For example, a dynamic port might vary its width and type to suit the signal that drives it.
- It defines any necessary port type and data rate checking;
- It defines any generics required by the black box HDL;
- It specifies the black box HDL and other files (e.g., EDIF) that are associated with the block;
- It defines the clocks and clock enables for the block (see the following topic on clock conventions).
- It declares whether the HDL has any combinational feed-through paths.

System Generator provides an object-based interface for configuring black boxes consisting of two types of objects: SysgenBlockDescriptors, used to define entity characteristics, and SysgenPortDescriptors, used to define port characteristics. This interface is used to provide System Generator information in the configuration M-function for black box about the block's interface, simulation model, and implementation.

If the HDL for a black box has at least one combinational path (for example, a direct feed-through from an input to an output port), the block must be tagged as combinational in its configuration M-function using the tagAsCombinational method. A black box can be a mixture (for example, some paths can be combinational while others are not). **It is essential that a block containing a combinational path be tagged as such. Doing so allows System Generator to identify such blocks to the Simulink simulator. If this is not done, simulation results are incorrect.**

The configuration M-function for a black box is invoked several times when a model is compiled. The function typically includes code that depends on the block's input ports. For example, sometimes it is necessary to set the data type and/or rate of an output port based on the attributes on an input port. It is sometimes also necessary to check the type and rate on an input port. At certain times when the function is invoked, Simulink might not yet know enough for such code to be executed.

To avoid the problems that arise when information is not yet known (in particular, exceptions), BlockDescriptor members *inputTypesKnown* and *inputRatesKnown* can be used. These are used to determine if Simulink is able, at the moment, to provide information about the input port types and rates respectively. The following code illustrates this point.

```
if (this_block.inputTypesKnown)
% set dynamic output port types
% set generics that depend on input port types
% check types of input ports
```

end

If all input rates are known, this code sets types for dynamic output ports, sets generics that depend on input port types, and verifies input port types are appropriate. Avoid the mistake of including code in these conditional blocks (e.g., a variable definition) that is needed by code outside of the conditional block.

Note that the code shown above uses an object named `this_block`. Every black box configuration M-function automatically makes `this_block` available through an input argument. In MATLAB, `this_block` is the object that represents the black box, and is used inside the configuration M-function to test and configure the black box. Every `this_block` object is an instance of the *SysgenBlockDescriptor* MATLAB class. The methods that can be applied to `this_block` are specified in Appendix A. A good way to generate example configuration M-function is to run the Configuration Wizard (described below) on simple VHDL entities.

The [Black Box Examples](#) are an excellent way to become familiar with black box configuration options.

## Sample Periods

The output ports, clocks, and clock enables on a black box must be assigned sample periods in the configuration M-function. If these periods are dynamic, or the black box needs to check rates, then the function must obtain the input port sample periods. Sample periods in the black box are expressed as integer multiples of the system rate as specified by the *Simulink System Period* field on the System Generator token. For example, if the *Simulink System Period* is 1/8, and a black box input port runs at the system rate (for example, at 1/8), then the configuration M-function sees 1 reported as the port's rate. Likewise, if the *Simulink System Period* is specified as  $\pi$ , and an output port should run four times as fast as the system rate (for example, at  $4*\pi$ ), then the configuration M-function should set the rate on the output port to 4. The appropriate rate for constant ports is Inf.

As an example of how to set the output rate on each output port, consider the following code segment:

```
block.outport(1).setRate(theInputRate);  
block.outport(2).setRate(theInputRate*5);  
block.outport(3).setRate(theInputRate*5);
```

The first line sets the first output port to the same rate as the input port. The next two lines set the output rate to 5 times the rate of the input.



## Block Parameters

The block parameters dialog box can be invoked by double-clicking the icon in your Simulink model.

### Basic tab

Parameters specific to the Basic tab are as follows:

- Block Configuration M-Function:** Specifies the name of the configuration M-function that is associated to the black box. Ordinarily the file containing the function is stored in the directory containing the model, but it can be stored anywhere on the MATLAB path. Note that MATLAB limits all function names (including those for configuration M-functions) to 63 characters. Do not include the file extension (".m" or ".p") in the edit box.
- Simulation Mode:** Tells the mode (Inactive, ISE® Simulator or External co-simulator) to use for simulation. When the mode is Inactive, the black box ignores all input data and writes zeroes to its output ports. Usually for this mode the black box should be coupled, using a Configurable Subsystem as described in the topic [Configurable Subsystems and System Generator](#).

System Generator uses Configurable Subsystems to allow two paths to be identified – one for producing simulation results, and the other for producing hardware. This approach gives the best simulation speed, but requires that a simulation model be constructed. When the mode is **ISE Simulator** or **External co-simulator**, simulation results for the black box are produced using co-simulation on the HDL associated with the black box. When the mode is **External co-simulator**, it is necessary to add a ModelSim HDL co-simulation block to the design, and to specify the name of the ModelSim block in the field labeled **HDL Co-Simulator To Use**. An example is shown below:

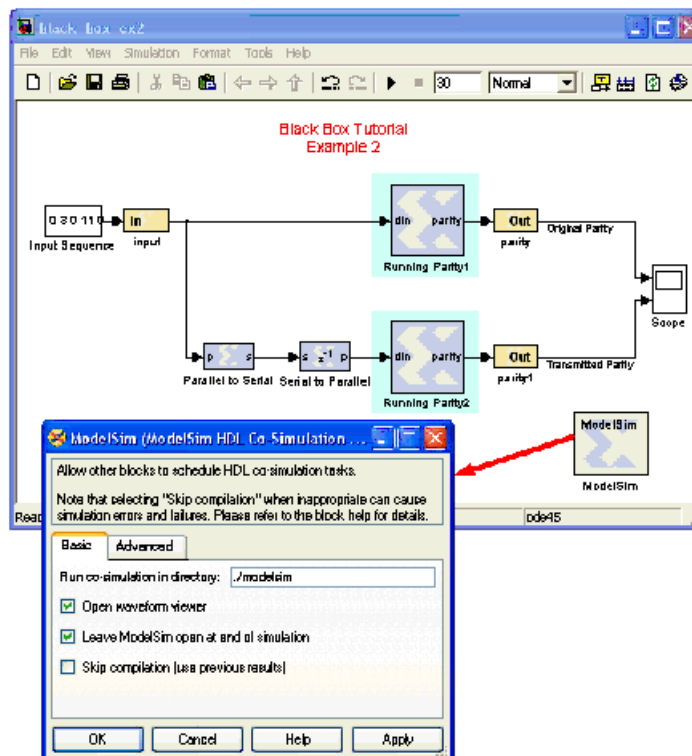

System Generator supports the ModelSim simulator from Mentor Graphics®, Inc. for HDL co-simulation. For co-simulation of Verilog black boxes, a mixed mode license is required. This is necessary because the portion of the design that System Generator writes is VHDL.

Usually the co-simulator block for a black box is stored in the same subsystem that contains the black box, but it is possible to store the block elsewhere. The path to a co-simulation block can be absolute, or can be relative to the subsystem containing the black box (e.g., "../ModelSim"). When simulating, each co-simulator block uses one license. To avoid running out of licenses, several black boxes can share the same co-simulation block. System Generator automatically generates and uses the additional VHDL needed to allow multiple blocks to be combined into a single ModelSim simulation.

## Data Type Translation for HDL Co-Simulation

During co-simulation, ports in System Generator drive ports in the HDL simulator, and vice-versa. Types of signals in the tools are not identical, and must be translated. The rules used for translation are the following.

- A signal in System Generator can be Boolean, unsigned or signed fixed point. Fixed-point signals can have indeterminate values, but Boolean signals cannot. If the signal's value is indeterminate in System Generator, then all bits of the HDL signal become 'X', otherwise the bits become 0's and 1's that represent the signal's value.
- To bring HDL signals back into System Generator, standard logic types are translated into Booleans and fixed-point values as instructed by the black box configuration M-function. When there is a width mismatch, an error is reported. Indeterminate signals of all varieties (weak high, weak low, etc.) are translated to System Generator indeterminates. Any signal that is partially indeterminate in HDL simulation (e.g., a bit vector in which only the topmost bit is indeterminate) becomes entirely indeterminate in System Generator.
- HDL to System Generator translations can be tailored by adding a custom simulation-only top-level wrapper to the VHDL component. Such a wrapper might, for example, translate every weak low signal to 0 or every indeterminate signal to 0 or 1 before it is returned to System Generator.

## An Example

The following is an example VHDL entity that can be associated to a System Generator black box. (This entity is taken from black box example [Importing a VHDL Module](#)).

```
library IEEE;
use IEEE.std_logic_1164.all;
use IEEE.numeric_std.all;
entity word_parity_block is
  generic (width : integer := 8);
port (din : in std_logic_vector(width-1 downto 0);
      parity : out std_logic);
end word_parity_block;
architecture behavior of word_parity_block is
begin
  WORD_PARITY_Process : process (din)
    variable partial_parity : std_logic := '0';
  begin
    partial_parity := '0';
    XOR_BIT_LOOP: for N in din'range loop
      partial_parity := partial_parity xor din(N);
    end loop; -- N
    parity <= partial_parity after 1 ns ;
  end process WORD_PARITY_Process;
end behavior;
```

The following is an example configuration M-function. It makes the VHDL shown above available inside a System Generator black box.

```
function word_parity_block_config(this_block)
this_block.setTopLevelLanguage('VHDL');
  this_block.setEntityName('word_parity_block');
  this_block.tagAsCombinational;
  this_block.addSimulinkInport('din');
  this_block.addSimulinkOutport('parity');
  parity = this_block.port('parity');
  parity.setWidth(1);
  parity.useHDLVector(false);
  % -----
  if (this_block.inputTypesKnown)
    this_block.addGeneric('width',
      this_block.port('din').width);
  end % if(inputTypesKnown)
  % -----
  % -----
  if (this_block.inputRatesKnown)
    din = this_block.port('din');
    parity.setRate(din.rate);
  end % if(inputRatesKnown)
  % -----
  this_block.addFile('word_parity_block.vhd');
  return;
```

## Device Support

Floating-Point support is restricted to the following devices:

Virtex-7, Kintex-7, Artix-7, Zynq-7000, Virtex-6, Spartan-6

## See Also

[Importing HDL Modules](#)

## ChipScope

This block is listed in the following Xilinx Blockset libraries: *Tools and Index*.

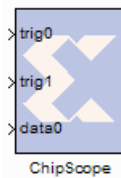

The Xilinx ChipScope™ block enables run-time debugging and verification of signals within an FPGA.

Deep capture memory and multiple trigger options are provided. Data is captured based on user defined trigger conditions and stored in internal block memory.

The Xilinx ChipScope block can be accessed at run-time using the ChipScope Pro Analyzer software. The Analyzer is used to configure the FPGA, setup trigger conditions and view the captured data at run-time. All control and data transfer is done using the JTAG port, eliminating the need to drive data off-chip using I/O pins. Data can be exported from the Analyzer and read back into the MATLAB workspace.

## Hardware and Software Requirements

The ChipScope™ Pro software, a download cable and a FPGA board with a JTAG connector are required. More information about purchasing ChipScope Pro can be found at [http://www.xilinx.com/ise/optional\\_prod/cspro.htm](http://www.xilinx.com/ise/optional_prod/cspro.htm)

The ChipScope Pro Analyzer supports the following download cables for communication between the PC and devices in the JTAG Boundary Scan chain:

- Xilinx Parallel Cable IV
- Xilinx Platform USB Cable
- MultiLINX (JTAG mode only)
- Agilent E5904B Option 500, FPGA Trace Port Analyzer (Agilent E5904B TPA).

## Block Parameters

The block parameters dialog box can be invoked by double-clicking the icon in your Simulink model.

Parameters specific to this block are as follows:

### Triggers

- **Number of trigger ports:** Multiple trigger ports allow a larger range of events to be detected and can reduce the amount of data that is stored. Up to 16 Trigger Ports can be selected. Trigger Port-numbering starts from 0 and they are named Trig0, Trig1, ... TrigN-1 by default. The trigger port can be renamed by specifying a name on the signal that is connected to the port.

### Trigger Settings

- **Display settings for trigger port:** For each trigger port, the number of match units and the match type need to be set. The pulldown menu displays settings for a particular trigger port. For N ports, the display options for trigger port 0 to N-1 can be shown.
- **Number of match units:** Using multiple match units per trigger port increases the flexibility of event detection. One to four match units can be used in conjunction to test for a trigger event. The trigger value is set at run-time in the ChipScope™ Pro Analyzer.
- **Match type:** This option can be set to one of the following six types:
  - a. **Basic:** performs = or <> comparisons

- b. **Basic with edges:** in addition to the basic operations high/low, low/high transitions can also be detected
- c. **Extended:** performs =, <>, >, <, <=, >= comparisons
- d. **Extended with edges:** in addition to the extended operations, high/low, low/high transitions can also be detected.
- e. **Range:** performs =, <>, >, >=, <, <=, in range, not in range comparisons
- f. **Range with edges:** in addition to the range operations, high/low, low/high transitions can also be detected.

**Note:** The Basic match type is the most area efficient and can compare 8-bits per FPGA slice. The Basic With Edges match unit compares 4-bits per slice, Extended and Extended With Edges operates on 2-bits per slice and, Range and Range With Edges can compare 1-bit per slice.

- **Use trigger ports as data:** When this option is selected, the data and trigger ports are identical and are named trig0/data0, trig1/data1, ... trigN-1/dataN-1, where N is the number of trigger ports. This mode is very common in most logic analyzers, since it enables the data that is used to trigger the ChipScope block to be captured and collected. This mode conserves hardware resources by limiting the amount of data that is captured.

When this option is not selected the data ports are completely independent of the trigger ports. The trigger ports are named trig0, trig1, ... trigN-1, and the data ports are named data0, data1, ... dataN-1. The ports can be renamed by specifying a name on the signal that is connected to the port.

- **Number of data ports:** Up to 256 bits of data can be captured per sample. This implies that the number of Data Ports multiplied by the number of bits-per-port should be less than or equal to 256. System Generator propagates the data width automatically; therefore only the number of data ports need to be specified.
- **Depth of capture buffer:** The depth of the capture buffer is a power of 2.

## ChipScope Project File

System Generator creates a project file for ChipScope™ Pro in order to group data signals connected to the block into buses. A bus is created for each data port so that it can be viewed as an analog waveform by using the Bus Plot feature in the ChipScope Pro Analyzer. Each data bus is scaled based on the binary point used in Simulink model. If the signals connected to the ChipScope block are named, these names are used in the ChipScope project file to name the buses.

A project can be loaded into the ChipScope Analyzer by selecting the **File > Import > Select New File** menu option and by choosing the ChipScope project file associated with the design. The project is saved as <block name>.cdc. <block name> is derived from the name of the Chipscope block in the design being compiled in the model's target directory.

## Importing Data Into MATLAB Workspace From ChipScope

To export data from the ChipScope™ Pro Analyzer, first select the buses in the Bus Plot window that are to be exported. Then select the **File > Export option**, select the ASCII format and choose 'Bus Plot Buses' to export. Press the **Export** button and save the file with a .prn extension. Within MATLAB, change the current working directory to the location where the .prn file has been saved and type:

```
xlLoadChipScopeData('<your file name>.prn');
```

This loads the data from the .prn file into the MATLAB workspace. The names of the new workspace variables are the ports names of the ChipScope™ block. If the signals connected to the ChipScope block are named, these names are used to create the MATLAB workspace variables. If

signal names are not specified the port names will depend on the Use Trigger Ports as Data option. If this option is selected, the default the workspace variables are named trig0\_data0, trig1\_data1, ... trigN-1\_dataN-1. If the option is not selected, by default the names of the variables are data0 and data1, ... dataN.

## Known Issues

- Only one ChipScope™ block can be instantiated in a System Generator design. Simulink Goto and From blocks can be used to easily route signals to the ChipScope block.
- A design or subsystem containing a ChipScope block must have at least one output port. If an output port does not exist, the ChipScope block is optimized away during VHDL synthesis.

## More Information

Please refer to the following web page for further details on the ChipScope™ Pro software:

<http://www.xilinx.com/chipscope>.

For a step-by-step tutorial on how to use this block, please refer to the topic [Using ChipScope Pro Analyzer for Real-Time Hardware Debugging](#).

## CIC Compiler 2.0

This block is listed in the following Xilinx Blockset libraries: *DSP and Index*.



The Xilinx CIC Compiler provides the ability to design and implement Cascaded Integrator-Comb (CIC) filters for a variety of Xilinx FPGA devices.

CIC filters, also known as Hogenauer filters, are multi-rate filters often used for implementing large sample rate changes in digital systems. They are typically employed in applications that have a large excess sample rate. That is, the system sample rate is much larger than the bandwidth occupied by the processed signal as in digital down converters (DDCs) and digital up converters (DUCs).

Implementations of CIC filters have structures that use only adders, subtractors, and delay elements. These structures make CIC filters appealing for their hardware-efficient implementations of multi-rate filtering.

### Block Parameters Dialog Box

#### Basic tab

Parameters specific to the Basic tab are:

##### Filter Specification

- **Filter type:** The CIC core supports both interpolation and decimation architectures. When the filter type is selected as decimator the input sample stream is down-sampled by the factor  $R$ . When an interpolator is selected the input sample is up-sampled by  $R$ .
- **Number of Stages:** Number of integrator and comb stages. If  $N$  stages are specified, there are  $N$  integrators and  $N$  comb stages in the filter. The valid range for this parameter is 3 to 6.
- **Differential delay:** Number of unit delays employed in each comb filter in the comb section of either a decimator or interpolator. The valid range of this parameter is 1 or 2.
- **Number of channels:** Number of channels to support in implementation. The valid range of this parameter is 1 to 16.

##### Sample Rate Change Specification

- **Sample rate changes:** Option to select between Fixed or Programmable.
- **Fixed or Initial Rate(ir):** Specifies initial or fixed sample rate change value for the CIC. The valid range for this parameter is 4 to 8192.
- **Minimum Rate (Range: 4..ir):** The minimum rate change value for programmable rate change. The valid range for this parameter is 4 to fixed rate (ir).
- **Maximum Rate (Range: ir..8192):** The maximum rate change value for programmable rate change. The valid range for this parameter is fixed rate (ir) to 8192.

##### Hardware Oversampling Specification

**Select format:** Choose Maximum\_Possible, Sample\_Period, or Hardware\_Oversampling\_Rate

**Sample period:** When this option is selected, the **nd** (new data -active high) input port is placed on the block. When **nd** is asserted, the data sample presented on the **din** port is loaded into the filter.

**Hardware Oversampling Rate:** Enter the hardware oversampling rate if you select **Hardware\_Oversampling\_Rate** as the format.



## Implementation tab

### Numerical Precision

- **Quantization:** Can be specified as Full\_Precision or Truncation.
- **Output Data Width:** Can be specified up to 48 bits for the Truncation option above.

### Optional

- **Use Xtreme DSP slice:** This field specifies that if possible, use the XtremeDSP slice (DSP48 type element) in the target device.
- **Use Streaming Interface:** Specifies whether or not to use a streaming interface for multiple channel implementations.

### Control Options

- **rst** (synchronous reset active High).
- **en** (clock enable active High) port to the block.
- **nd** (new data - active high) When this signal is asserted, the data sample presented on **din** port is loaded into the filter. This control port is only placed on the block when Sample Period is the selected format. See Hardware Oversampling Specification on the Basic tab.

Other parameters used by this block are explained in the topic [Common Options in Block Parameter Dialog Boxes](#).

## LogiCORE™ Documentation

[LogiCORE IP CIC Compiler 2.0](#)

## Device Support

Virtex-7, Kintex-7, Virtex-6, Virtex-5, Virtex-4,  
Spartan-6, Spartan-3/XA, Spartan-3E/XA, Spartan-3A/3AN/3A DSP/XA

## CIC Compiler 3.0

This block is listed in the following Xilinx Blockset libraries: AXI4, DSP and Index.

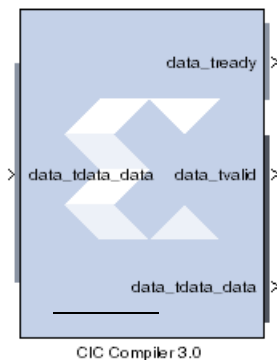

The Xilinx CIC Compiler provides the ability to design and implement AXI4-Stream-compliant Cascaded Integrator-Comb (CIC) filters for a variety of Xilinx FPGA devices.

CIC filters, also known as Hogenauer filters, are multi-rate filters often used for implementing large sample rate changes in digital systems. They are typically employed in applications that have a large excess sample rate. That is, the system sample rate is much larger than the bandwidth occupied by the processed signal as in digital down converters (DDCs) and digital up converters (DUCs). Implementations of CIC filters have structures that use only adders, subtractors, and delay elements. These structures make CIC filters appealing for their hardware-efficient implementations of multi-rate filtering.

### Sample Rates and the CIC Compiler Block

The CIC Compiler block must always run at the system rate because the CIC Compiler block has a programmable rate change option and Simulink cannot inherently support it. You should use the "ready" output signal to indicate to downstream blocks when a new sample is available at the output of the CIC Compiler block.

The CIC will downsample the data, but the sample rate will remain at the clock rate. If you look at the output of the CIC Compiler block, you will see each output data repeated  $R$  times for a rate change of  $R$  while the **data\_tvalid** signal pulses once every  $R$  cycles. The downstream blocks can be clocked at lower-than-system rates without any problems as long as the clock is never slower than the rate change  $R$ .

There are several different ways this can be handled. You can leave the entire design running at the system rate then use registers with enables, or enables on other blocks to capture data at the correct time. Or alternatively, you can use a downsample block corresponding to the lowest rate change  $R$ , then again use enable signals to handle the cases when there are larger rate changes.

If there are not many required rate changes, you can use MUX blocks and use a different downsample block for each different rate change. This might be the case if the downstream blocks are different depending on the rate change, basically creating different paths for each rate. Using enables as described above will probably be the most efficient method.

If you are not using the CIC Compiler block in a programmable mode, you can place an up/down sample block after the CIC Compiler to correctly pass on the sample rate to downstream blocks that will inherit the rate and build the proper CE circuitry to automatically enable those downstream blocks at the new rate.

### Block Parameters Dialog Box

#### Filter Specification tab

Parameters specific to the Filter Specification tab are:

##### Filter Specification

- Filter Type:** The CIC core supports both interpolation and decimation architectures. When the filter type is selected as decimator the input sample stream is down-sampled by the factor  $R$ . When an interpolator is selected the input sample is up-sampled by  $R$ .

- **Number of Stages:** Number of integrator and comb stages. If  $N$  stages are specified, there are  $N$  integrators and  $N$  comb stages in the filter. The valid range for this parameter is 3 to 6.
- **Differential Delay:** Number of unit delays employed in each comb filter in the comb section of either a decimator or interpolator. The valid range of this parameter is 1 or 2.
- **Number of Channels:** Number of channels to support in implementation. The valid range of this parameter is 1 to 16.

#### Sample Rate Change Specification

- **Sample Rate Changes:** Option to select between Fixed or Programmable.
- **Fixed or Initial Rate(ir):** Specifies initial or fixed sample rate change value for the CIC. The valid range for this parameter is 4 to 8192.
- **Minimum Rate:** The minimum rate change value for programmable rate change. The valid range for this parameter is 4 to fixed rate (ir).
- **Maximum Rate:** The maximum rate change value for programmable rate change. The valid range for this parameter is fixed rate (ir) to 8192.

#### Hardware Oversampling Specification

**Select format:** Choose Maximum\_Possible, Sample\_Period, or Hardware\_Oversampling\_Rate.

Selects which method is used to specify the hardware

oversampling rate. This value directly affects the level of parallelism of the block implementation and resources used. When “Maximum Possible” is selected, the block uses the maximum oversampling given the sample period of the signal connected to the Data field of the `s_axis_data_tdata` port. When you select “Hardware Oversampling Rate”, you can specify the oversampling rate. When “Sample Period” is selected, the block clock is connected to the system clock and the value specified for the Sample Period parameter sets the input sample rate the block supports. The Sample Period parameter also determines the hardware oversampling rate of the block. When “Sample Period” is selected, the block is forced to use the `s_axis_data_tvalid` control port.

**Sample period:** Integer number of clock cycles between input samples. When the multiple channels have been specified, this value should be the integer number of clock cycles between the time division multiplexed input sample data stream.

**Hardware Oversampling Rate:** Enter the hardware oversampling rate if you select **Hardware\_Oversampling\_Rate** as the format.

## Implementation tab

#### Numerical Precision

- **Quantization:** Can be specified as Full\_Precision or Truncation.
- **Output Data Width:** Can be specified up to 48 bits for the Truncation option above.

#### Optional

- **Use Xtreme DSP slice:** This field specifies that if possible, use the XtremeDSP slice (DSP48 type element) in the target device.
- **Use Streaming Interface:** Specifies whether or not to use a streaming interface for multiple channel implementations.

#### Control Options

- **ACLKEN** Specifies if the block has a clock enable port (the equivalent of selecting the Has ACLKEN option in the CORE Generator GUI).

- **ARESETn** Specifies that the block has a reset port. Active low synchronous clear. A minimum ARESETn pulse of two cycles is required.
- **Has TREADY** Specifies if the block has a TREADY port for the Data Output Channel (the equivalent of selecting the Has\_DOUT\_TREADY option in the CORE Generator GUI)

Other parameters used by this block are explained in the topic [Common Options in Block Parameter Dialog Boxes](#).

## LogiCORE™ Documentation

[LogiCORE IP CIC Compiler 3.0](#)

## Device Support

Virtex-7, Kintex-7, Artix-7, Zynq-7000, Virtex-6, Spartan-6

# Clock Enable Probe

This block is listed in the following Xilinx Blockset libraries: Basic Elements and Index.

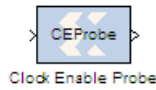

The Xilinx Clock Enable (CE) Probe provides a mechanism for extracting derived clock enable signals from Xilinx signals in System Generator models.

The probe accepts any Xilinx signal type as input, and produces a Boolean output signal. The Boolean output can be used at any point in the design where Booleans are acceptable. The probe output is a cyclical pulse that mimics the behavior of an ideal clock enable signal used in the hardware implementation of a multirate circuit. The frequency of the pulse is derived from the input signal's sample period. The enable pulse is asserted at the end of the input signal's sample period for the duration of one Simulink system period. For signals with a sample period equal to the Simulink system period, the block's output is always one.

Shown below is an example model with an attached analysis scope that demonstrates the usage and behavior of the Clock Enable Probe. The Simulink system sample period for the model is specified in the System Generator token as 1.0 seconds. In addition to the Simulink system period, the model has three other sample periods defined by the Down Sample blocks. Clock Enable Probes are placed after each Down Sample block and extract the derived clock enable signal. The probe outputs are run to output gateways and then to the scope for analysis. Also included in the model is CLK probe that produces a Double representation of the hardware system clock. The scope output shows the output from the four Clock Enable probes in addition to the CLK probe output.

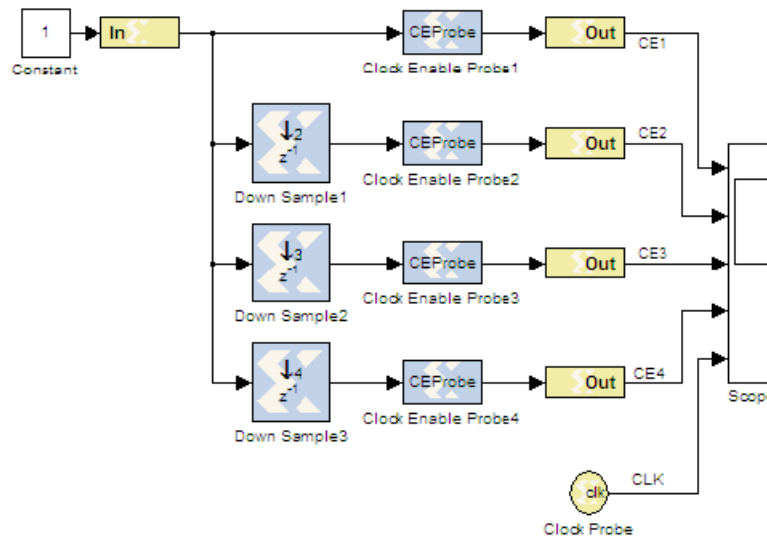

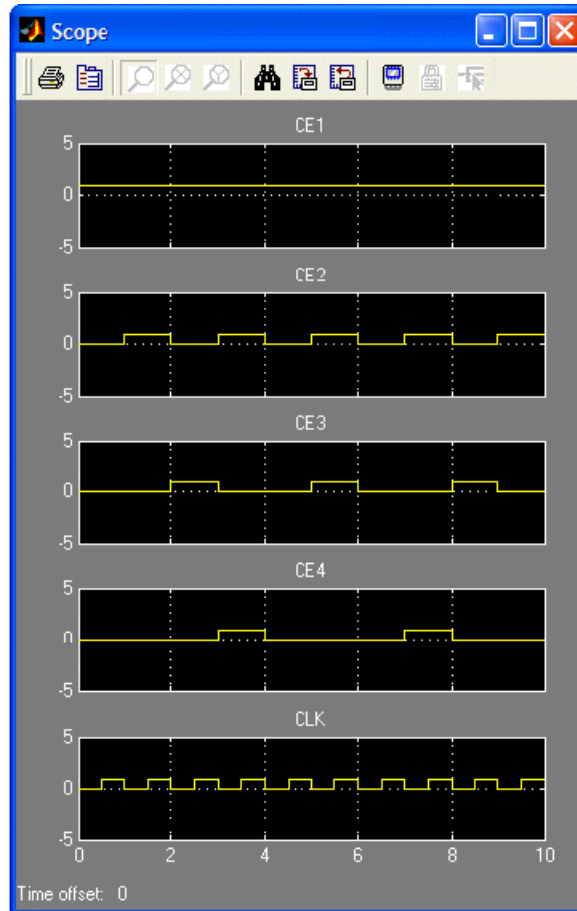

## Options

- **Use clock enable signal without Multi-Cycle path constraints:** Used to disable multi-cycle path constraints on the generated signal from the Clock Enable Probe block. This is typically applied when the signal being generated is used as a separate timing signal that is not clock-enable related.

## Clock Probe

*This block is listed in the following Xilinx Blockset libraries: Tools and Index.*



The Xilinx Clock Probe generates a double-precision representation of a clock signal with a period equal to the Simulink system period.

The output clock signal has a 50/50 duty cycle with the clock asserted at the start of the Simulink sample period. The Clock Probe's double output is useful only for analysis, and cannot be translated into hardware.

There are no parameters for this block.

## CMult

This block is listed in the following Xilinx Blockset libraries: *Math, Floating-Point and Index*.

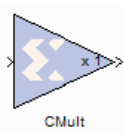

The Xilinx CMult block implements a *gain* operator, with output equal to the product of its input by a constant value. This value can be a MATLAB expression that evaluates to a constant.

### Block Parameters

The block parameters dialog box can be invoked by double-clicking the icon in your Simulink model.

#### Basic tab

Parameters specific to the Basic Tab are as follows:

##### Constant

- **Fixed-point:** Use fixed-point data type
- **Floating-point:** Use floating-point data type
- **Value:** can be a constant or an expression. If the constant cannot be expressed exactly in the specified fixed-point type, its value is rounded and saturated as needed. A positive value is implemented as an unsigned number, a negative value as signed.

##### Fixed-point Precision

- ◆ **Number of bits:** specifies the bit location of the binary point of the constant, where bit zero is the least significant bit.
- ◆ **Binary point:** position of the binary point.

##### Floating-point Precision

- **Single:** Specifies single precision (32 bits)
- **Double:** Specifies double precision (64 bits)
- **Custom:** Activates the field below so you can specify the Exponent width and the Fraction width.

**Exponent width:** Specify the exponent width

**Fraction width:** Specify the fraction width

#### Output tab

##### Precision:

This parameter allows you to specify the output precision for fixed-point arithmetic. Floating point arithmetic output will always be **Full** precision.

- **Full:** The block uses sufficient precision to represent the result without error.
- **User Defined:** If you don't need full precision, this option allows you to specify a reduced number of total bits and/or fractional bits.

##### User-Defined Precision

##### Floating-point Precision



- ◆ **Signed (2's comp):** The output is a Signed (2's complement) number.
- ◆ **Unsigned:** The output is an Unsigned number.
- ◆ **Number of bits:** specifies the bit location of the binary point of the output number, where bit zero is the least significant bit.
- ◆ **Binary point:** position of the binary point. in the fixed-point output

#### Quantization

Refer to the section [Overflow and Quantization](#).

#### Overflow

Refer to the section [Overflow and Quantization](#).

## Implementation tab

Parameters specific to the Implementation tab are:

- **Use behavioral HDL description (otherwise use core):** when selected, System Generator uses behavioral HDL, otherwise it uses the Xilinx LogiCORE™ Multiplier. When this option is not selected (false) System Generator internally uses the behavioral HDL model for simulation if any of the following conditions are true:
  - a. The constant value is 0 (or is truncated to 0).
  - b. The constant value is less than 0 and its bit width is 1.
  - c. The bit width of the constant or the input is less than 1 or is greater than 64.
  - d. The bit width of the input data is 1 and its data type is xlFix.

**Note:** This option is true for all Virtex® and Spartan® device families. Also, for Floating-point operations, the block always uses the Floating-point Operator core.

#### Core Parameters

- **Implement using:** specifies whether to use distributed RAM or block RAM.
- **Test for optimum pipelining:** checks if the Latency provided is at least equal to the optimum pipeline length supported for the given configuration of the block. Latency values that pass this test imply that the core produced is optimized for speed.

Other parameters used by this block are explained in the topic [Common Options in Block Parameter Dialog Boxes](#).

## LogiCORE™ Documentation

[LogiCORE IP Multiplier v11.2](#)

[LogiCORE IP Floating-Point Operator v6.1](#)

## Device Support

Virtex-7, Kintex-7, Virtex-6, Virtex-5, Virtex-4, Spartan-6, Spartan-3/XA, Spartan-3E/XA, Spartan-3A/3AN/3A DSP/XA

Floating-Point support is restricted to the following devices:

Virtex-7, Kintex-7, Virtex-6, Spartan-6

## Complex Multiplier 3.1

This block is listed in the following Xilinx Blockset libraries: *DSP and Index and Math*.

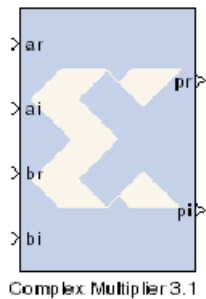

The Xilinx Complex Multiplier block multiplies two complex numbers.

All operands and the results are represented in signed two's complement format. The operand widths and the result width are parameterizable.

### Block Parameters Dialog Box

#### Page 1 tab

Parameters specific to the Basic tab are:

Multiplier Construction Options

- **Use\_LUTs:** Use LUTs in the fabric.
- **Use\_Mults:** Use embedded multipliers/XtremeDSP slices

Optimization Goal

Only available if **Use\_Mults** is selected.

- **Resources:** Uses the 3-real-multiplier structure. However, a 4-real-multiplier structure is used when the 3-1- multiplier structure uses more multiplier resources.
- **Performance:** Always uses the 4-real multiplier structure to allow the best frequency performance to be achieved.

Output Product Range

Select the required MSB and LSB of the output product. The values are automatically set to provide the full-precision product when the A and B operand widths are set. The output is sign-extended if required. If rounding is required, set the Output LSB to a value greater than zero to enable the rounding options.

#### Page 2 tab

Core Latency

You can adjust the block latency as required. The default is -1 which tells System Generator to pipeline the underlying LogiCORE for maximum performance.

Output Rounding

If rounding is required, the **Output LSB** must be greater than zero.

- **Truncate:** Truncate the output.
- **Random\_Rounding:** When this option is selected, a round\_cy input port is added to the block to allow a carry-in bit to be input. See the section of the Complex Multiplier 3.1 Product Specification for a full explanation.

#### Optional Ports

- **en:** Clock Enable – Activates an optional enable (en) pin on the block. When the enable signal is not asserted the block holds its current state until the enable signal is asserted again or the reset signal is asserted. Reset signal has precedence over the enable signal. The enable signal has to run at a multiple of the block's sample rate. The signal driving the enable port must be Boolean.
- **rst:** Reset – Activates an optional reset (rst) pin on the block. When the reset signal is asserted the block goes back to its initial state. Reset signal has precedence over the optional enable signal available on the block. The reset signal has to run at a multiple of the block's sample rate. The signal driving the reset port must be Boolean.

## LogiCORE™ Documentation

[LogiCORE IP Complex Multiplier v3.1](#)

## Device Support

Virtex-7, Kintex-7, Virtex-6, Virtex-5, Virtex-4, Spartan-6, Spartan-3/XA, Spartan-3E/XA, Spartan-3A/3AN/3A DSP/XA

## Complex Multiplier 5.0

This block is listed in the following Xilinx Blockset libraries: AXI4, DSP, Index and Math.

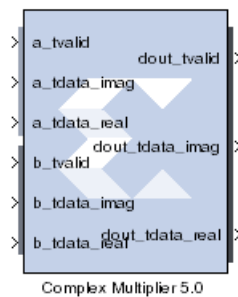

The Complex Multiplier 5.0 block implements AXI4-Stream compliant, high-performance, optimized complex multipliers for Virtex-6 and Spartan-6 devices based on user-specified options.

The two multiplicand inputs and optional rounding bit are input on independent AXI4-Stream channels as slave interfaces and the resulting product output using an AXI4-Stream master interface.

Within each channel, operands and the results are represented in signed two's complement format. The operand widths and the result width are parameterizable.

Refer to the topic [AXI Interface](#) for more detailed information on the AXI Interface.

### Block Parameters Dialog Box

#### Page 1 tab

Parameters specific to the Basic tab are:

Channel A Options:

- **Has TLAST:** Adds a tlast input port to the A channel of the block.
- **Has TUSER:** Adds a tuser input port to the A channel of the block.

Channel B Options:

- **Has TLAST:** Adds a tlast input port to the B channel of the block.
- **Has TUSER:** Adds a tuser input port to the B channel of the block.

Multiplier Construction Options

- **Use\_Mults:** Use embedded multipliers/XtremeDSP slices
- **Use\_LUTs:** Use LUTs in the fabric to construct multipliers.

Optimization Goal

Only available if **Use\_Mults** is selected.

- **Resources:** Uses the 3-real-multiplier structure. However, a 4-real-multiplier structure is used when the 3-1- multiplier structure uses more multiplier resources.
- **Performance:** Always uses the 4-real multiplier structure to allow the best frequency performance to be achieved.

Flow Control Options

- **Blocking:** Selects “Blocking” mode. In this mode, the lack of data on one input channel does block the execution of an operation if data is received on another input channel.
- **NonBlocking:** Selects “Non-Blocking” mode. In this mode, the lack of data on one input channel does not block the execution of an operation if data is received on another input channel.

## Page 2 tab

## Output Product Range

Select the output bit width. The values are automatically set to provide the full-precision product when the A and B operand widths are set. The output is sign-extended if required.

The natural output width for complex multiplication is  $(A_{PortWidth} + B_{PortWidth} + 1)$ . When the Output Width is set to be less than this, the most significant bits of the result are those output; -the remaining bits will either be truncated or rounded according to Output Rounding option selected. That is to say, the output MSB is now fixed at  $(A_{PortWidth} + B_{PortWidth})$ . For details please refer to the Complex Multiplier v4.0 datasheet.

## Output Rounding

If rounding is required, the **Output LSB** must be greater than zero.

- **Truncate:** Truncate the output.
- **Random\_Rounding:** When this option is selected, a ctrl\_tvalid and ctrl\_tdata input port is added to the block. Bit 0 of ctrl\_tdata input determines the particular type of rounding for the operation. See the section of the Complex Multiplier 4.0 Product Specification for a full explanation.

## Channel CTRL Options

The following options are activated when **Random Rounding** is selected.

- **Has TLAST:** Adds a ctrl\_tlast input port to the block.
- **Has TUSER:** Adds a ctrl\_user input port to the block.
- **TUSER Width:** Specifies the bit width of the ctrl\_tuser input port.

## Output TLAST Behavior

Determines the behavior of the dout\_tlast output port.

- **Null:** Output is null.
- **Pass\_A\_TLAST:** Pass the value of the a\_tlast input port to the dout\_tlast output port.
- **Pass\_B\_TLAST:** Pass the value of the b\_tlast input port to the dout\_tlast output port.
- **Pass CTRL\_TLAST:** Pass the value of the ctrl\_tlast input port to the dout\_tlast output port.
- **OR\_all\_TLASTS:** Pass the logical OR of all the present TLAST input ports.
- **AND\_all\_TLASTS:** Pass the logical AND of all the present TLAST input ports.

## Core Latency

- **Latency Configuration**
  - ◆ **Automatic:** Block latency is automatically determined by System Generator by pipelining the underlying LogiCORE for maximum performance.
  - ◆ **Manual:** You can adjust the block latency specifying the minimum block latency.
- **Minimum Latency:** Entry field for manually specifying the minimum block latency.

## Control Signals

- **ACLKEN:** Enables the clock enable (aclken) pin on the core. All registers in the core are enabled by this control signal.
- **ARESETn:** Active-low synchronous clear input that always takes priority over ACLKEN. A minimum ARESETn active pulse of two cycles is required, since the signal is internally

registered for performance. A pulse of one cycle resets the core, but the response to the pulse is not in the cycle immediately following.

## Advanced tab

### Block Icon Display

- **Display shortened port names:** On by default. When unchecked, `dout_tvalid`, for example, becomes `m_axis_dout_tvalid`.

## How to Migrate from Complex Multiplier 3.1 to Complex Multiplier 5.0

### Design Description

This example shows how to migrate from the non-axi Complex Multiplier block to AXI4 Complex Multiplier block using the same or similar block parameters. Some of the parameters between non-AXI4 and AXI4 versions might not be identical exactly due to some changes in certain features and block interfaces.

The following model is used to illustrate the design migration. For more detail, refer to the datasheet for this IP core

## Example showing how to migrate to AXI4 Complex Multiplier IP block

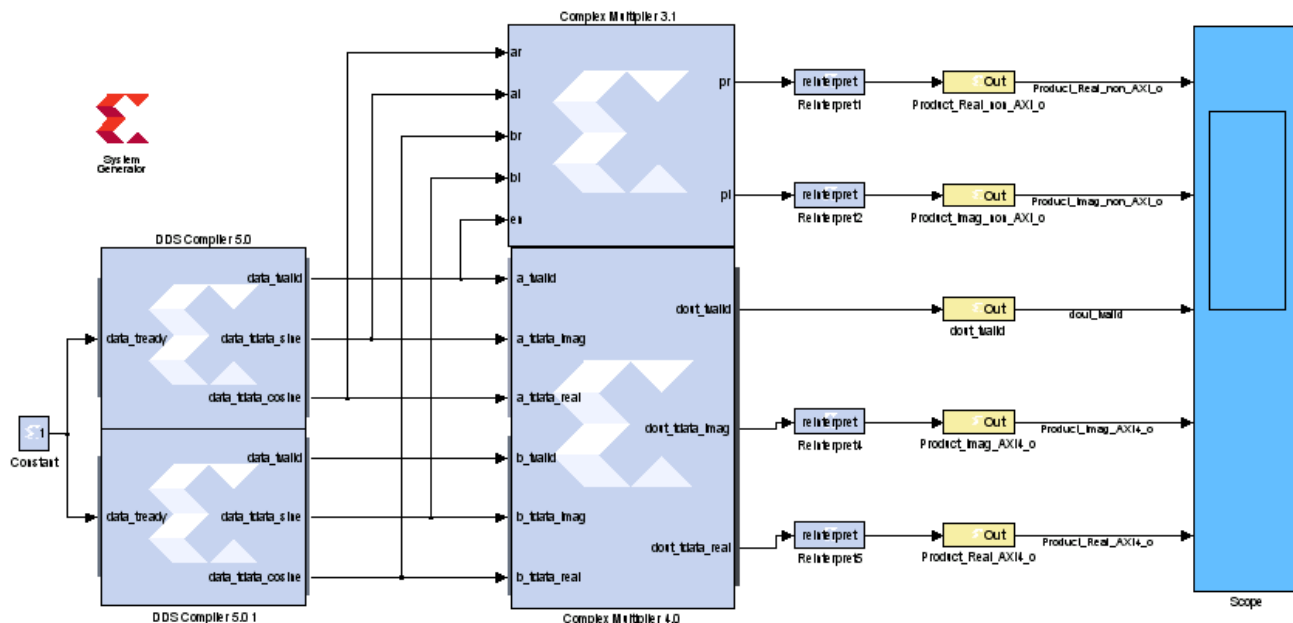

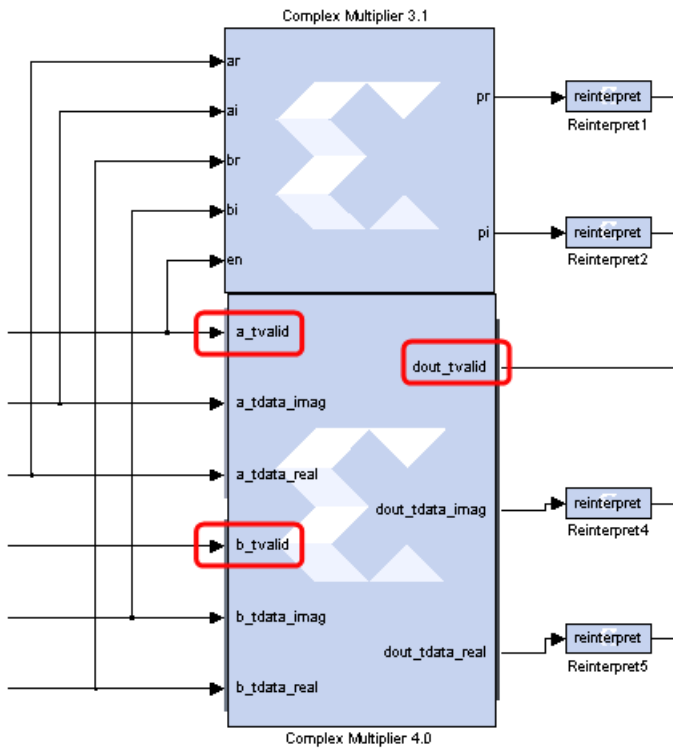
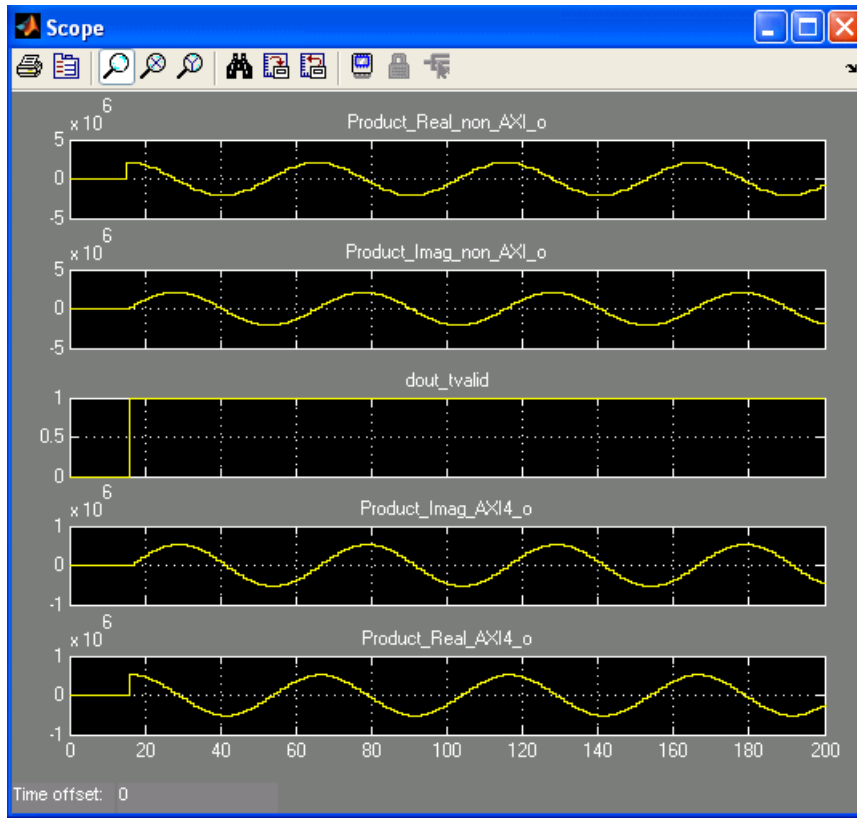

### Data Path and Control Signals:

One noticeable difference between the non-AXI and AXI4 version is the `tvalid` signal. The AXI4 version provides both the input and output `tvalid` control signals as shown by the figure above. For the streaming application, these control signals might not be necessary. However, for some bursty data flows, they can be used to gate the valid input and output data without having to use additional decoding circuits.

For this particular example, the following control signals are utilized:

`a_tvalid`: is driven by the Master “`d_valid`” from the “DDS Compiler 5.0” block

`b_tvalid`: is driven by the Master “`d_valid`” from the “DDS Compiler 5.0 1” block

`dout_tvalid`: can be used to drive other input Slave `tvalid` signals

**Note:** The `a_tvalid` and `b_tvalid` are operated independently from each other.

## LogiCORE™ Documentation

[LogiCORE IP Complex Multiplier v5.0](#)

## Device Support

Virtex-7, Kintex-7, Virtex-6, Spartan-6



## Concat

*This block is listed in the following Xilinx Blockset libraries: Basic Elements, Data Types, and Index.*

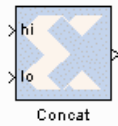

The Xilinx Concat block performs a concatenation of  $n$  bit vectors represented by unsigned integer numbers, for example,  $n$  unsigned numbers with binary points at position zero.

The Xilinx [Reinterpret](#) block provides capabilities that can extend the functionality of the Concat block.

### Block Interface

The block has  $n$  input ports, where  $n$  is some value between 2 and 1024, inclusively, and one output port. The first and last input ports are labeled `hi` and `low`, respectively. Input ports between these two ports are not labeled. The input to the `hi` port will occupy the most significant bits of the output and the input to the `low` port will occupy the least significant bits of the output.

### Block Parameters

The block parameters dialog box can be invoked by double-clicking the icon in your Simulink model.

Parameters specific to this block are as follows:

- **Number of Inputs:** specifies number of inputs, between 2 and 1024, inclusively, to concatenate together.

Other parameters used by this block are explained in the topic [Common Options in Block Parameter Dialog Boxes](#).

The Concat block does not use a Xilinx LogiCORE™.

## Configurable Subsystem Manager

*This block is listed in the following Xilinx Blockset libraries: Tools and Index.*



Configurable Subsystem  
Manager

The Xilinx Configurable Subsystem Manager extends Simulink's configurable subsystem capabilities to allow a subsystem configurations to be selected for hardware generation as well as for simulation.

This block can be used to create Simulink library blocks (subsystems) that have special capabilities when used with the System Generator software. For details on how configurable subsystems, refer to the topic [Configurable Subsystems and System Generator](#).

System Generator will automatically insert Configurable Subsystem Manager blocks into library subsystems that it generates through its "Import as Configurable Subsystem" capability. It is also possible to hand-build library subsystems that take advantage of the Simulink and System Generator configurable subsystem capabilities.

Recall that a configurable subsystem consists of a collection of sub-blocks, exactly one of which "represents" the subsystem at any given time. (The so-called "block choice" for the subsystem specifies which sub-block should be the representative.) The representative is the sub-block used to produce results for the subsystem when simulating.

System Generator designs can be simulated, but can also be translated into hardware, and it is often useful to identify a second block to be used as a configurable subsystem's "hardware representative". The hardware representative is the sub-block used to translating the configurable subsystem into hardware. For example, suppose a configurable subsystem consists of two sub-blocks, namely a black box whose HDL implements a filter, and a subsystem that implements the same filter using ordinary System Generator blocks. Then it is natural to use the subsystem as the representative and the black box as the hardware representative, for example, to use the subsystem in simulations, and the black box HDL to generate hardware.

The configurable subsystem manager specifies which sub-block in a System Generator configurable subsystem should be the hardware representative. To specify the hardware representative, do the following: 1) Place a manager inside one of the sub-blocks, and 2) Use the manager's **When generating, use** parameter to select the hardware representative.

**Note:** It is only possible to use a configurable subsystem manager by placing it inside a sub-block of a configurable subsystem. This means that at least one sub-block must be a subsystem.

**Note:** When several sub-blocks contain managers, the managers automatically synchronize so they agree on the choice of hardware representative.

## Block Parameters

The dialog box for a configurable subsystem manager is shown below:

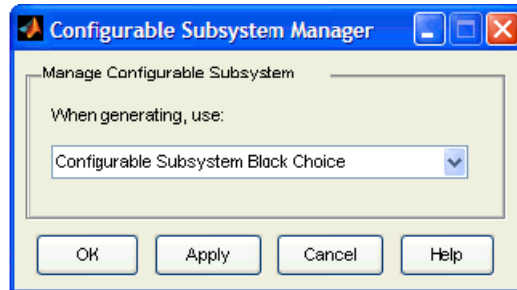

This block has one parameter, labeled **When generating, use**. The parameter specifies which sub-block to use as the hardware representative. An example list of choices is shown below.

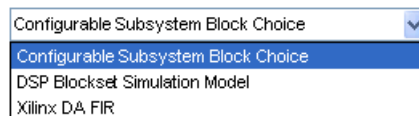

When **Configurable Subsystem Block Choice** is selected, the sub-block specified as the representative for the configurable subsystem is also used for generating hardware. Otherwise, the sub-block selected from the list is used as the hardware representative.

## Constant

This block is listed in the following Xilinx Blockset libraries: *Basic Elements, Control Logic, Math, Floating-Point and Index.*

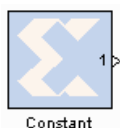

The Xilinx Constant block generates a constant that can be a fixed-point value, a Boolean value, or a DSP48 instruction. This block is similar to the Simulink constant block, but can be used to directly drive the inputs on Xilinx blocks.

### DSP48 Instruction Mode

The constant block, when set to create a DSP48 instruction, is useful for generating DSP48 control sequences. The figure below shows an example. The example implements a 35x35-bit multiplier using a sequence of four instructions in a DSP48 block. The constant blocks supply the desired instructions to a multiplexer that selects each instruction in the desired sequence.

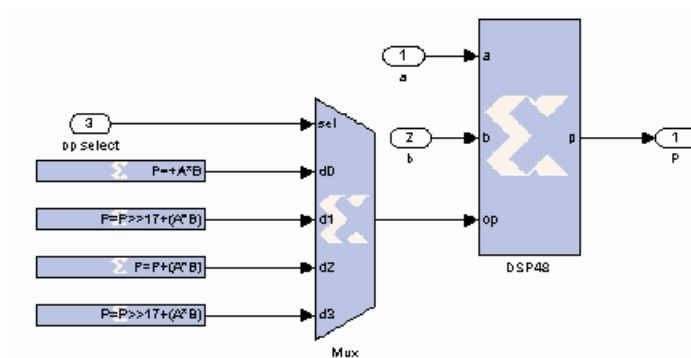

## Block Parameters

The block parameters dialog box can be invoked by double-clicking the icon in your Simulink model.

### Basic tab

Parameters specific to the Basic tab are as follows:

#### Constant Value

Specifies the value of the constant. When changed, the new value appears on the block icon. If the constant data type is specified as fixed-point and cannot be expressed exactly in the specified fixed-point type, its value is rounded and saturated as needed. A positive value is implemented as an unsigned number, a negative value as signed.

#### Output Precision

- Specifies the data type of the output. Can be **Boolean**, **Fixed-point**, or **Floating-point**.

Arithmetic Type: If the Output Type is specified as Fixed-point, you can select **Signed (2's comp)**, **Unsigned** or **DSP48 instruction** as the Arithmetic Type.

#### Fixed-point Precision

- ◆ **Number of bits:** specifies the bit location of the binary point of the output number, where bit zero is the least significant bit.
- ◆ **Binary point:** position of the binary point. in the fixed-point output

### Floating-point Precision

- **Single:** Specifies single precision (32 bits)
- **Double:** Specifies double precision (64 bits)
- **Custom:** Activates the field below so you can specify the Exponent width and the Fraction width.

**Exponent width:** Specify the exponent width

**Fraction width:** Specify the fraction width

### Sample Period

- **Sampled Constant:** allows a sample period to be associated with the constant output and inherited by blocks that the constant block drives. (This is useful mainly because the blocks eventually target hardware and the Simulink sample periods are used to establish hardware clock periods.)

## DSP48 tab

### DS48 Instruction

When DSP48 Instruction is selected for type, the DSP48 tab is activated. A detailed description of the DSP48 can be found in the DSP48 block description.

- **DSP48 operation:** displays the selected DSP48 instruction.
- **Operation select:** allows the selection of a DSP48 instruction. Selecting custom reveals mask parameters that allow the formation of an instruction in the form  $z\_mux +/- (yx\_mux + carry)$ .

### Custom Instruction

- **Z Mux:** specifies the 'Z' source to the DSP48's adder to be one of {'0', 'C', 'PCIN', 'P','C', 'PCIN>>17', 'P>>17'}.
- **Operand:** specifies whether the DSP48's adder is to perform addition or subtraction.
- **YX Muxes:** specifies the 'YX' source to the DSP48's adder to be one of {'0','P', 'A:B', 'A\*B', 'C', 'P+C', 'A:B+C' }. 'A:B' implies that A[17:0] is concatenated with B[17:0] to produce a 36-bit value to be used as an input to the DSP48 adder.
- **Carry input:** specifies the 'carry' source to the DSP48's adder to be one of {'0', '1', 'CIN', '~SIGN(P or PCIN)', '~SIGN(A:B or A\*B)', '~SIGND(A:B or A\*B)'}. '~SIGN (P or PCIN)' implies that the carry source is either P or PCIN depending on the Z Mux setting. '~SIGN(A\*B or A:B)' implies that the carry source is either A\*B or A:B depending on the YX Mux setting. The option '~SIGND (A\*B or A:B)' selects a delayed version of '~SIGN(A\*B or A:B)'.

Other parameters used by this block are explained in the topic [Common Options in Block Parameter Dialog Boxes](#).

## Appendix: DSP48 Control Instruction Format

Instruction Field Name	Location	Mnemonic	Description
YX Mux	op[3:0]	0	0
		P	DSP48 output register
		A:B	Concat inputs A and B (A is MSB)
		A*B	Multiplication of inputs A and B
		C	DSP48 input C
		P+C	DSP48 input C plus P
		A:B+C	Concat inputs A and B plus C register
Z Mux	op[6:4]	0	0
		PCIN	DSP48 cascaded input from PCOUT
		P	DSP48 output register
		C	DSP48 C input
		PCIN>>17	Cascaded input downshifted by 17
		P>>17	DSP48 output register downshifted by 17
Operand	op[7]	+	Add
		-	Subtract
Carry In	op[8]	0 or 1	Set carry in to 0 or 1
		CIN	Select cin as source
		'~SIGN(P or PCIN)	Symmetric round P or PCIN
		'~SIGN(A:B or A*B)	Symmetric round A:B or A*B
		'~SIGND(A:B or A*B)	Delayed symmetric round of A:B or A*B

# Convert

This block is listed in the following Xilinx Blockset libraries: *Basic Elements, Data Types, Math, Floating-Point and Index.*



The Xilinx Convert block converts each input sample to a number of a desired arithmetic type. For example, a number can be converted to a signed (two's complement) or unsigned value.

## Block Parameters

The block parameters dialog box can be invoked by double-clicking the icon in your Simulink model.

### Basic tab

Parameters specific to the Basic Tab are as follows:

#### Output Precision

Specifies the output data type. Can be **Boolean**, **Fixed-point**, or **Floating-point**.

**Arithmetic Type:** If the Output Type is specified as Fixed-point, you can select **Signed (2's comp)** or **Unsigned** as the Arithmetic Type.

#### Fixed-point Precision

- ◆ **Number of bits:** specifies the bit location of the binary point, where bit zero is the least significant bit.
- ◆ **Binary point:** specifies the bit location of the binary point, where bit zero is the least significant bit.

#### Floating-point Precision

- **Single:** Specifies single precision (32 bits)
- **Double:** Specifies double precision (64 bits)
- **Custom:** Activates the field below so you can specify the Exponent width and the Fraction width.

**Exponent width:** Specify the exponent width

**Fraction width:** Specify the fraction width

#### Quantization

Quantization errors occur when the number of fractional bits is insufficient to represent the fractional portion of a value. The options are to **Truncate** (for example, to discard bits to the right of the least significant representable bit), or to **Round(unbiased: +/- inf)** or **Round (unbiased: even values)**.

**Round(unbiased: +/- inf)** also known as "Symmetric Round (towards +/- inf)" or "Symmetric Round (away from zero)". This is similar to the Matlab round() function. This method rounds the value to the nearest desired bit away from zero and when there is a value at the midpoint between two possible rounded values, the one with the larger magnitude is selected. For example, to round 01.0110 to a Fix\_4\_2, this yields 01.10, since 01.0110 is exactly between 01.01 and 01.10 and the latter is further from zero.

**Round (unbiased: even values)** also known as "Convergent Round (toward even)" or "Unbiased Rounding". Symmetric rounding is biased because it rounds all ambiguous midpoints away from zero which means the average magnitude of the rounded results is larger than the average magnitude of the raw results. Convergent rounding removes this by alternating between a symmetric round toward zero and symmetric round away from zero. That is, midpoints are rounded toward the nearest even number. For example, to round 01.0110 to a Fix\_4\_2, this yields 01.10, since 01.0110 is exactly between 01.01 and 01.10 and the latter is even. To round 01.1010 to a Fix\_4\_2, this yields 01.10, since 01.1010 is exactly between 01.10 and 01.11 and the former is even.

### Overflow

Overflow errors occur when a value lies outside the representable range. For overflow the options are to **Saturate** to the largest positive/smallest negative value, to **Wrap** (for example, to discard bits to the left of the most significant representable bit), or to **Flag as error** (an overflow as a Simulink error) during simulation. **Flag as error** is a simulation only feature. The hardware generated is the same as when **Wrap** is selected.

### Optional Ports

**Provide enable port:** Activates an optional enable (en) pin on the block. When the enable signal is not asserted the block holds its current state until the enable signal is asserted again or the reset signal is asserted.

### Implementation tab

Parameters specific to the Implementation tab are as follows:

- **Pipeline for maximum performance:** directs the block to use pipeline registers to achieve the maximum performance. Block latency might increase.

Other parameters used by this block are explained in the topic [Common Options in Block Parameter Dialog Boxes](#).

## LogiCORE™ Documentation

[LogiCORE IP Floating-Point Operator v6.1](#)

## Device Support

Floating-Point support is restricted to the following devices:

Virtex-7, Kintex-7, Artix-7, Zynq-7000, Virtex-6, Spartan-6



# Convolution Encoder 7.0

This block is listed in the following Xilinx Blockset libraries: *Communication and Index*.

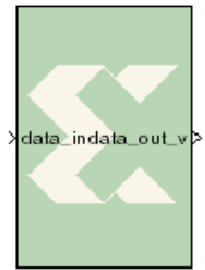

Convolution Encoder 7.0

The Xilinx Convolution Encoder block implements an encoder for convolution codes. Ordinarily used in tandem with a Viterbi decoder, this block performs forward error correction (FEC) in digital communication systems.

Values are encoded using a linear feed forward shift register which computes modulo-two sums over a sliding window of input data, as shown in the figure below. The length of the shift register is specified by the constraint length. The convolution codes specify which bits in the data window contribute to the modulo-two sum. Resetting the block will set the shift register to zero. The encoder rate is the ratio of input to output bit length; thus, for example a rate 1/2 encoder outputs two bits for each input bit. Similarly, a rate 1/3 encoder outputs three bits for each input bit.

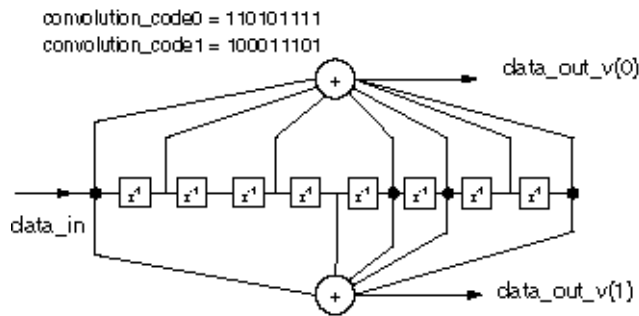

## Block Parameters Dialog Box

The following figure shows the block parameters dialog box.

page\_0 tab

Parameters specific to the Basic tab are:

### Data Rates

- **Input Rate:** Punctured: Only the input rate can be modified. Its value can range from 2 to 12, resulting in a rate n/m encoder where n is the input rate and  $n < m < 2n$
- **Output Rate:** Not Punctured: Only the output rate can be modified. Its value can be integer values from 2 to 7, resulting in a rate 1/2 or rate 1/7 encoder, respectively

### Punctures

- **Punctured:** Determines whether the block is punctured
- **Dual Output:** Specifies a dual-channel punctured block
- **Puncture Code0 and Code1:** The two puncture pattern codes are used to remove bits from the encoded data prior to output. The length of each puncture code must be equal to the puncture input rate, and the total number of bits set to 1 in the two codes must equal the puncture output rate (m) for the codes to be valid. A 0 in any position indicates that the output bit from the encoder is not transmitted. See the associated LogiCORE data sheet for an example.

page\_1 tab

#### Convolution

- **Constraint length:** Constraint Length: Equals  $n+1$ , where  $n$  is the length of the constraint register in the encoder.
- **Convolution code:** Array of binary convolution codes. Output rate is derived from the array length. Between 2 and 7 (inclusive) codes can be entered.

#### Optional Pins

- **ND:** When the ND (New Data) input is sampled logic-High, it signals that a new symbol on DATA\_IN should be sampled on the same rising clock edge.
- **RFD:** RFD (Ready for Data) indicates that the core is ready to sample new data on DIN.
- **FD\_IN:** The FD\_IN (First Data) input is present only on punctured blocks and is used to indicate the start of a new puncture group.
- **RFFD:** When RFFD (Ready for First Data) is High, it indicates that FD\_IN can be asserted.
- **RDY:** The RDY (Ready) output indicates valid data on DATA\_OUT\_V
- **SCLR:** When SCLR is asserted (High), all the core flip-flops are synchronously initialized.
- **CE:** When CE is deasserted (Low), all the synchronous inputs are ignored and the block remains in its current state.

Other parameters used by this block are explained in the topic [Common Options in Block Parameter Dialog Boxes](#).

## LogiCORE™ Documentation

[LogiCORE IP Convolution Encoder 7.0](#)

## Device Support

Virtex-7, Kintex-7, Virtex-6, Virtex-5, Virtex-4, Spartan-6, Spartan-3/XA, Spartan-3E/XA, Spartan-3A/3AN/3A DSP/XA

# Convolution Encoder 8.0

This block is listed in the following Xilinx Blockset libraries: AXI4, Communication and Index.

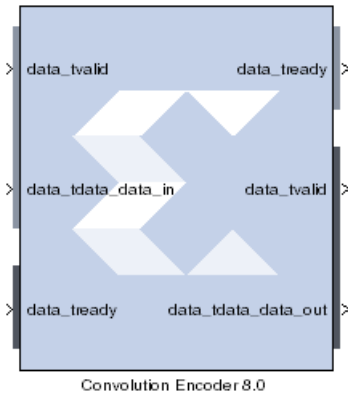

The Xilinx Convolution Encoder block implements an encoder for convolution codes. Ordinarily used in tandem with a Viterbi decoder, this block performs forward error correction (FEC) in digital communication systems. This block adheres to the AMBA® AXI4-Stream standard.

Values are encoded using a linear feed forward shift register which computes modulo-two sums over a sliding window of input data, as shown in the figure below. The length of the shift register is specified by the constraint length. The convolution codes specify which bits in the data window contribute to the modulo-two sum. Resetting the block will set the shift register to zero. The encoder rate is the ratio of input to output bit length;

thus, for example a rate 1/2 encoder outputs two bits for each input bit. Similarly, a rate 1/3 encoder outputs three bits for each input bit.

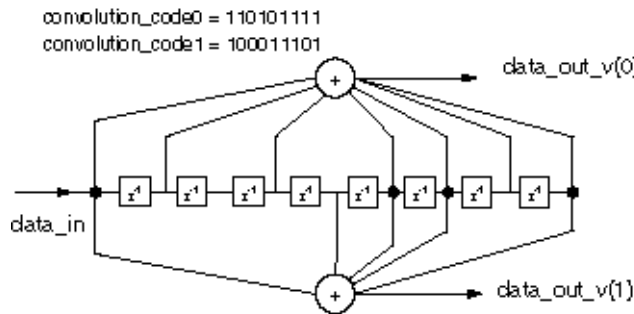

## Block Parameters Dialog Box

The following figure shows the block parameters dialog box.

page\_0 tab

Parameters specific to the Basic tab are:

Data Rates

- **Input Rate:** Punctured: Only the input rate can be modified. Its value can range from 2 to 12, resulting in a rate n/m encoder where n is the input rate and  $n < m < 2n$
- **Output Rate:** Not Punctured: Only the output rate can be modified. Its value can be integer values from 2 to 7, resulting in a rate 1/2 or rate 1/7 encoder, respectively

Punctures

- **Punctured:** Determines whether the block is punctured
- **Dual Output:** Specifies a dual-channel punctured block
- **Puncture Code0 and Code1:** The two puncture pattern codes are used to remove bits from the encoded data prior to output. The length of each puncture code must be equal to the puncture input rate, and the total number of bits set to 1 in the two codes must equal the puncture output rate (m) for the codes to be valid. A 0 in any position indicates that the output bit from the encoder is not transmitted. See the associated LogiCORE data sheet for an example.

#### Radix

- **Convolution code radix:** Select Binary, Octal, or Decimal.

**Note:** This Radix option is currently disabled.

#### Convolution

- **Constraint length:** Constraint Length: Equals  $n+1$ , where  $n$  is the length of the constraint register in the encoder.
- **Convolution code:** Array of binary convolution codes. Output rate is derived from the array length. Between 2 and 7 (inclusive) codes can be entered.

#### Optional Pins

- **Aclken:** Adds a **aclken** pin to the block. This signal carries the clock enable and must be of type `Bool`.
- **Aresetn:** Adds a **aresetn** pin to the block. This signal resets the block and must be of type `Bool`. The signal must be asserted for at least 2 clock cycles, however, it does not have to be asserted before the decoder can start decoding. If this pin is not selected, System Generator ties this pin to inactive (high) on the core.

Other parameters used by this block are explained in the topic [Common Options in Block Parameter Dialog Boxes](#).

## LogiCORE™ Documentation

[LogiCORE IP Convolution Encoder 8.0](#)

## Device Support

Virtex-7, Kintex-7, Artix-7, Zynq-7000, Virtex-6, Spartan-6

## CORDIC 4.0

This block is listed in the following Xilinx Blockset libraries: *DSP and Index and Math*.



The Xilinx CORDIC 4.0 block implements a generalized coordinate rotational digital computer (CORDIC) algorithm.

The CORDIC core implements the following equation types:

- Rotate
  - Translate
  - Sin\_and\_Cos
  - Sinh\_and\_Cosh
  - Arc\_Tan
- Arc\_Tanh
  - Square\_Root

Two architectural configurations are available for the CORDIC core:

- A fully parallel configuration with single-cycle data throughput at the expense of silicon area
- A word serial implementation with multiple-cycle throughput but occupying a small silicon area

A coarse rotation is performed to rotate the input sample from the full circle into the first quadrant. (The coarse rotation stage is required as the CORDIC algorithm is only valid over the first quadrant). An inverse coarse rotation stage rotates the output sample into the correct quadrant.

The CORDIC algorithm introduces a scale factor to the amplitude of the result, and the CORDIC core provides the option of automatically compensating for the CORDIC scale factor.

## Block Parameters Dialog Box

### Page 1 tab

Functional Selection:

- **Rotate:** When selected, the input vector, (X,Y), is rotated by the input angle using the CORDIC algorithm. This generates the scaled output vector,  $Z_i * (X', Y')$ .
- **Translate:** When selected, the input vector (X,Y) is rotated using the CORDIC algorithm until the Y component is zero. This generates the scaled output magnitude,  $Z_i * \text{Mag}(X,Y)$ , and the output phase,  $\text{Atan}(Y/X)$ .
- **Sin\_and\_Cos:** When selected, the unit vector is rotated, using the CORDIC algorithm, by input angle. This generates the output vector ( $\text{Cos}(\ )$ ,  $\text{Sin}(\ )$ ).
- **Sinh\_and\_Cosh:** When selected, the CORDIC algorithm is used to move the vector (1,0) through hyperbolic angle  $p$  along the hyperbolic curve. The hyperbolic angle represents the log of the area under the vector (X, Y) and is unrelated to a trigonometric angle. This generates the output vector ( $\text{Cosh}(p)$ ,  $\text{Sinh}(p)$ ).
- **Arc\_Tan:** When selected, the input vector (X,Y) is rotated (using the CORDIC algorithm) until the Y component is zero. This generates the output angle,  $\text{Atan}(Y/X)$ .
- **Arc\_Tanh:** When selected, the CORDIC algorithm is used to move the input vector (X,Y) along the hyperbolic curve until the Y component reaches zero. This generates the hyperbolic "angle,"  $\text{Atanh}(Y/X)$ . The hyperbolic angle represents the log of the area under the vector (X,Y) and is unrelated to a trigonometric angle.

- **Square\_Root:** When selected a simplified CORDIC algorithm is used to calculate the positive square root of the input.

Architectural configuration

- **Word\_Serial:** Select for a hardware result with a small area.
- **Parallel:** Select for a hardware result with high throughput

Pipelining mode

- **No\_Pipelining:** The CORDIC core is implemented without pipelining.
- **Optimal:** The CORDIC core is implemented with as many stages of pipelining as possible without using any additional LUTs.
- **Maximum:** The CORDIC core is implemented with a pipeline after every shift-add sub stage.

## Page 2 tab

Data format

- **SignedFraction:** Default setting. The X and Y inputs and outputs are expressed as fixed-point 2's complement numbers with an integer width of 2-bits
- **UnsignedFraction:** Available only for Square Root functional configuration. The X and Y inputs and outputs are expressed as unsigned fixed-point numbers with an integer width of 1-bit.
- **UnsignedInteger:** Available only for Square Root functional configuration. The X and Y inputs and outputs are expressed as unsigned integers.

Phase format

- **Radians:** The phase is expressed as a fixed-point 2's complement number with an integer width of 3-bits, in radian units.
- **Scaled\_Radians:** The phase is expressed as fixed-point 2's complement number with an integer width of 3-bits, with pi-radian units. One scaled-radian equals  $\pi * 1$  radians.

Output Options

- **Output width:** Controls the width of the output ports, X\_OUT, Y\_OUT, PHASE\_OUT. The Output Width can be configured in the range 8 to 48 bits.

Round mode

- **Truncate:** The X\_OUT, Y\_OUT, and PHASE\_OUT outputs are truncated.
- **Round\_Pos\_Inf:** The X\_OUT, Y\_OUT, and PHASE\_OUT outputs are rounded (1/2 rounded up).
- **Round\_Pos\_Neg\_Inf:** The outputs X\_OUT, Y\_OUT, and PHASE\_OUT are rounded (1/2 rounded up, -1/2 rounded down).
- **Nearest\_Even:** The X\_OUT, Y\_OUT, and PHASE\_OUT outputs are rounded toward the nearest even number (1/2 rounded down and 3/2 is rounded up).

## Page 3 tab

Advanced Configuration Parameters

- **Iterations:** Controls the number of internal add-sub iterations to perform. When set to zero, the number of iterations performed is determined automatically based on the required accuracy of the output.

- **Precision:** Configures the internal precision of the add-sub iterations. When set to zero, internal precision is determined automatically based on the required accuracy of the output and the number of internal iterations.
- **Coarse rotation:** Controls the instantiation of the coarse rotation module. Instantiation of the coarse rotation module is the default for the following functional configurations: Vector rotation, Vector translation, Sin and Cos, and Arc Tan. If Coarse Rotation is turned off for these functions then the input/output range is limited to the first quadrant ( $-\pi/4$  to  $+\pi/4$ ).  
  
Coarse rotation is not required for the Sinh and Cosh, Arctanh, and Square Root configurations. The standard CORDIC algorithm operates over the first quadrant. Coarse Rotation extends the CORDIC operational range to the full circle by rotating the input sample into the first quadrant and inverse rotating the output sample back into the appropriate quadrant.
- **Compensation scaling:** Controls the compensation scaling module used to compensate for CORDIC magnitude scaling. CORDIC magnitude scaling affects the Vector Rotation and Vector Translation functional configurations, and does not affect the SinCos, SinhCosh, ArcTan, ArcTanh and Square Root functional configurations. For the latter configurations, compensation scaling is set to No Scale Compensation.

#### Optional Pins

- **en:** When the enable signal is not asserted the block holds its current state until the enable signal is asserted again or the reset signal is asserted. Reset signal has precedence over the enable signal. The enable signal has to run at a multiple of the block's sample rate. The signal driving the enable port must be Boolean.
- **rst:** When the reset signal is asserted the block goes back to its initial state. Reset signal has precedence over the optional enable signal available on the block. The reset signal has to run at a multiple of the block's sample rate. The signal driving the reset port must be Boolean.
- **nd:** A new sample is on the input ports.
- **rdy:** New output data is ready.
- **X out:** Data output port.
- **Y out:** Data output port.
- **Phase output:** Data output port.

## LogiCORE™ Documentation

[LogiCORE IP CORDIC v4.0](#)

## Device Support

Virtex-7 and Kintex-7, Virtex-6, Virtex-5, Virtex-4,  
Spartan-6, Spartan-3/XA, Spartan-3E/XA, Spartan-3A/XA/3AN/3A DSP

## CORDIC 5.0

This block is listed in the following Xilinx Blockset libraries: *DSP and Index and Math*.

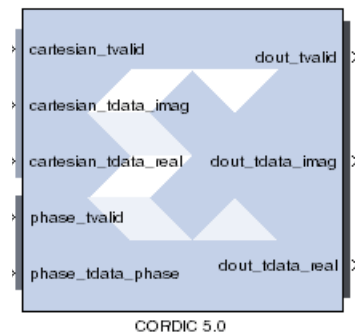

The Xilinx CORDIC 5.0 block implements a generalized coordinate rotational digital computer (CORDIC) algorithm and is AXI compliant.

The CORDIC core implements the following equation types:

- Rotate
- Translate
- Sin\_and\_Cos
- Sinh\_and\_Cosh
- Arc\_Tan
- Arc\_Tanh
- Square\_Root

Two architectural configurations are available for the CORDIC core:

- A fully parallel configuration with single-cycle data throughput at the expense of silicon area
- A word serial implementation with multiple-cycle throughput but occupying a small silicon area

A coarse rotation is performed to rotate the input sample from the full circle into the first quadrant. (The coarse rotation stage is required as the CORDIC algorithm is only valid over the first quadrant). An inverse coarse rotation stage rotates the output sample into the correct quadrant.

The CORDIC algorithm introduces a scale factor to the amplitude of the result, and the CORDIC core provides the option of automatically compensating for the CORDIC scale factor.

### Changes from CORDIC 4.0 to CORDIC 5.0

#### AXI compliant

- The CORDIC 5.0 block is AXI compliant.

#### Ports Renamed

- **en** to **acken**
- **rst** to **aresetn**
- **rdy** maps to **dout\_tready**. **cartesian\_tready** and **phase\_tready** are automatically added when their respective channels are added.
- **x\_in** to **cartesian\_tdata\_real**



- **y\_in** to **cartesian\_tdata\_imag**
- **phase\_in** to **phase\_tdata\_phase**
- **x\_out** to **dout\_tdata\_real**
- **y\_out** to **dout\_tdata\_imag**
- **phase\_out** to **dout\_tdata\_phase**

### Port Changes

- The data output ports are not optional in CORDIC 5.0. The data output ports are selected based on the Function selected.
- There are separate **tuser**, **tlast** and **treedy** ports for the Cartesian and Phase input channels.
- The **dout\_tlast** output port can be configured to provide **tlast** from the Cartesian input channel, from the Phase input channel, or the AND and or the OR of all **tlasts**.

### Optimization

- When you select **Blocking** mode for the AXI behavior, you can then select whether the core is configured for minimum **Resources** or maximum **Performance**.

### Displaying Port Names on the Block Icon

- You can select **Display shortened port names** to trim the length of the AXI port names on the block icon.

## Block Parameters Dialog Box

### Page 1 tab

Functional selection:

- **Rotate**: When selected, the input vector, (real,imag), is rotated by the input angle using the CORDIC algorithm. This generates the scaled output vector,  $Z_i * (real', imag')$ .
- **Translate**: When selected, the input vector (real,imag) is rotated using the CORDIC algorithm until the imag component is zero. This generates the scaled output magnitude,  $Z_i * Mag(real,imag)$ , and the output phase,  $Atan(imag/real)$ .
- **Sin\_and\_Cos**: When selected, the unit vector is rotated, using the CORDIC algorithm, by input angle. This generates the output vector (Cos( ), Sin( )).
- **Sinh\_and\_Cosh**: When selected, the CORDIC algorithm is used to move the vector (1,0) through hyperbolic angle p along the hyperbolic curve. The hyperbolic angle represents the log of the area under the vector (real, imag) and is unrelated to a trigonometric angle. This generates the output vector (Cosh(p), Sinh(p)).
- **Arc\_Tan**: When selected, the input vector (real,imag) is rotated (using the CORDIC algorithm) until the imag component is zero. This generates the output angle,  $Atan(imag/real)$ .
- **Arc\_Tanh**: When selected, the CORDIC algorithm is used to move the input vector (real,imag) along the hyperbolic curve until the imag component reaches zero. This generates the hyperbolic "angle,"  $Atanh(imag/real)$ . The hyperbolic angle represents the log of the area under the vector (real,imag) and is unrelated to a trigonometric angle.

**Square\_Root**: When selected a simplified CORDIC algorithm is used to calculate the positive square root of the input.

#### Architectural configuration

- **Word\_Serial:** Select for a hardware result with a small area.
- **Parallel:** Select for a hardware result with high throughput

#### Pipelining mode

- **No\_Pipelining:** The CORDIC core is implemented without pipelining.
- **Optimal:** The CORDIC core is implemented with as many stages of pipelining as possible without using any additional LUTs.
- **Maximum:** The CORDIC core is implemented with a pipeline after every shift-add sub stage.

#### Data format

- **SignedFraction:** Default setting. The real and imag inputs and outputs are expressed as fixed-point 2's complement numbers with an integer width of 2-bits
- **UnsignedFraction:** Available only for Square Root functional configuration. The real and imag inputs and outputs are expressed as unsigned fixed-point numbers with an integer width of 1-bit.
- **UnsignedInteger:** Available only for Square Root functional configuration. The real and imag inputs and outputs are expressed as unsigned integers.

#### Phase format

- **Radians:** The phase is expressed as a fixed-point 2's complement number with an integer width of 3-bits, in radian units.
- **Scaled\_Radians:** The phase is expressed as fixed-point 2's complement number with an integer width of 3-bits, with pi-radian units. One scaled-radian equals  $\text{Pi} * 1$  radians.

#### Input/Output Options

- **Input width:** Controls the width of the input ports **cartesian\_tdata\_real**, **cartesian\_tdata\_imag**, and **phase\_tdata\_phase**. The Input width range 8 to 48 bits.
- **Output width:** Controls the width of the output ports **dout\_tdata\_real**, **dout\_tdata\_imag**, and **dout\_tdata\_phase**. The Output width range 8 to 48 bits.

#### Round mode

- **Truncate:** The real, imag, and phase outputs are truncated.
- **Round\_Pos\_Inf:** The real, imag, and phase outputs are rounded (1/2 rounded up).
- **Round\_Pos\_Neg\_Inf:** The real, imag, and phase outputs are rounded (1/2 rounded up, -1/2 rounded down).
- **Nearest\_Even:** The real, imag, and phase outputs are rounded toward the nearest even number (1/2 rounded down and 3/2 is rounded up).

#### Page 2 tab

#### Advanced Configuration Parameters

- **Iterations:** Controls the number of internal add-sub iterations to perform. When set to zero, the number of iterations performed is determined automatically based on the required accuracy of the output.

- **Precision:** Configures the internal precision of the add-sub iterations. When set to zero, internal precision is determined automatically based on the required accuracy of the output and the number of internal iterations.
- **Compensation scaping:** Controls the compensation scaling module used to compensate for CORDIC magnitude scaling. CORDIC magnitude scaling affects the Vector Rotation and Vector Translation functional configurations, and does not affect the SinCos, SinhCosh, ArcTan, ArcTanh and Square Root functional configurations. For the latter configurations, compensation scaling is set to No Scale Compensation.
- **Coarse rotation:** Controls the instantiation of the coarse rotation module. Instantiation of the coarse rotation module is the default for the following functional configurations: Vector rotation, Vector translation, Sin and Cos, and Arc Tan. If Coarse Rotation is turned off for these functions then the input/output range is limited to the first quadrant ( $-\pi/4$  to  $+\pi/4$ ).

Coarse rotation is not required for the Sinh and Cosh, Arctanh, and Square Root configurations. The standard CORDIC algorithm operates over the first quadrant. Coarse Rotation extends the CORDIC operational range to the full circle by rotating the input sample into the first quadrant and inverse rotating the output sample back into the appropriate quadrant.

### Optional ports

#### Standard

- **aclken:** When this signal is not asserted, the block holds its current state until the signal is asserted again or the aresetn signal is asserted. The aresetn signal has precedence over this clock enable signal. This signal has to run at a multiple of the block 's sample rate. The signal driving this port must be Boolean.
- **aresetn:** When this signal is asserted, the block goes back to its initial state. This reset signal has precedence over the optional aclken signal available on the block. The reset signal has to run at a multiple of the block's sample rate. The signal driving this port must be Boolean.
- **tready:** Adds **dout\_tready** port if Blocking mode is activated.

#### Cartesian

- **tlast:** Adds a tlast input port to the Cartesian input channel.
- **tuser:** Adds a tuser input port to the Cartesian input channel.  
**tuser width:** Specifies the bit width of the Cartesian tuser input port.

#### Phase

- **tlast:** Adds a tlast input port to the Phase input channel.
- **tuser:** Adds a tuser input port to the Phase input channel.  
**tuser width:** Specifies the bit width of the Phase tuser input port.

#### Tlast behavior

- **Null:** Data output port.
- **Pass\_Cartesian\_TLAST:** Data output port.
- **Pass\_Phase\_TLAST:** Data output port.
- **OR\_all\_TLASTS:** Pass the logical OR of all the present TLAST input ports.
- **AND\_all\_TLASTS:** Pass the logical AND of all the present TLAST input ports

#### Flow control

#### AXI behavior

- **NonBlocking:** Selects “Non-Blocking” mode. In this mode, the lack of data on one input channel does not block the execution of an operation if data is received on another input channel.
- **Blocking:** Selects “Blocking” mode. In this mode, the lack of data on one input channel does block the execution of an operation if data is received on another input channel.

### Optimization

When NonBlocking mode is selected, the following optimization options are activated:

- **Resources:** core is configured for minimum resources.
- **Performance:** core is configured for maximum performance.

### Implementation tab

#### Block Icon Display

**Display shortened port names:** this option is ON by default. When unselected, the full AXI name of each port is displayed on the block icon.

## LogiCORE™ Documentation

[LogiCORE IP CORDIC v5.0](#)

## Device Support

Virtex-7, Kintex-7, Artix-7, Zynq-7000, Virtex-6, Spartan-6

## Counter

This block is listed in the following Xilinx Blockset libraries: *Basic Elements, Control Logic, Math, and Index.*



The Xilinx Counter block implements a free running or count-limited type of an up, down, or up/down counter. The counter output can be specified as a signed or unsigned fixed-point number.

Free running counters are the least expensive in FPGA hardware. The free running up, down, or up/down counter can also be configured to load the output of the counter with a value on the input *din* port by selecting the **Provide Load Pin** option in the block's parameters.

$$out(n) = \begin{cases} InitialValue & \text{if } n = 0 \\ (out(n-1) + Step) \bmod 2^N & \text{otherwise} \end{cases}$$

The output for a free running up counter is calculated as follows:

$$out(n) = \begin{cases} InitialValue & \text{if } n = 0 \\ din(n-1) & \text{if } load(n-1) = 1 \\ (out(n-1) + Step) \bmod 2^N & \text{otherwise} \end{cases}$$

Here *N* denotes the number of bits in the counter. The free running down counter calculations replace addition with subtraction.

For the free running up/down counter, the counter performs addition when input up port is 1 or subtraction when the input up port is 0.

A count-limited counter is implemented by combining a free running counter with a comparator. Count limited counters are limited to only 64 bits of output precision. Count limited types of a counter can be configured to step between the initial and ending values, provided the step value evenly divides the difference between the initial and ending values.

The output for a count limited up counter is calculated as follows:

$$out(n) = \begin{cases} InitialValue & \text{if } n = 0 \text{ or } out(n-1) = CountLimit \\ (out(n-1) + Step) \bmod 2^N & \text{otherwise} \end{cases}$$

The count-limited down counter calculation replaces addition with subtraction. For the count limited up/down counter, the counter performs addition when input up port is 1 or subtraction when input up port is 0.

The output for a free running up counter with load capability is calculated as follows:

$$out(n) = \begin{cases} StartCount & \text{if } n = 0 \text{ or } rst(n) = 1 \\ din & \text{if } rst(n) = 0 \text{ and } load(n) = 1 \\ (out(n-1) + CountByValue) \bmod 2^N & \text{otherwise} \end{cases}$$

Here *N* denotes the number of bits in the counter. The down counter calculations replace addition by subtraction.

## Block Parameters

The block parameters dialog box can be invoked by double-clicking the icon in your Simulink model.

### Basic tab

Parameters specific to the Basic tab are as follows:

- **Counter type:** specifies the counter to be a count-limited or free running counter.
- **Number of bits:** specifies the number of bits in the block output.
- **Binary point:** specifies the location of the binary point in the block output.
- **Output type:** specifies the block output to be either Signed or Unsigned.
- **Initial value:** specifies the initial value to be the output of the counter.
- **Count to value:** specifies the ending value, the number at which the count limited counter resets. A value of Inf denotes the largest representable output in the specified precision. This cannot be the same as the initial value.
- **Step:** specifies the increment or decrement value.
- **Count direction:** specifies the direction of the count (up or down) or provides an optional input port up (when up/down is selected) for specifying the direction of the counter.
- **Provide load Port:** when checked, the block operates as a free running load counter with explicit load and din port. The load capability is available only for the free running counter.

### Implementation tab

Parameters specific to the Implementation tab are as follows:

#### Implementation Details

**Use behavioral HDL (otherwise use core):** The block is implemented using behavioral HDL. This gives the downstream logic synthesis tool maximum freedom to optimize for performance or area. Core Parameters

- **Implement using:** Core logic can be implemented in **Fabric** or in a **DSP48**, if a DSP48 is available in the target device. The default is **Fabric**.

Other parameters used by this block are explained in the topic [Common Options in Block Parameter Dialog Boxes](#).

## LogiCORE™ Documentation

[LogiCORE IP Binary Counter v11.0](#)

## Device Support

Virtex-7 and Kintex-7, Virtex-6, Virtex-5, Virtex-4,  
Spartan-6, Spartan-3/XA, Spartan-3E/XA, Spartan-3A/3AN/3A DSP/XA

## DDS Compiler 4.0

This block is listed in the following Xilinx Blockset libraries: *DSP and Index*.



The Xilinx DDS Compiler block is a direct digital synthesizer, also commonly called a numerically controlled oscillator (NCO). The block uses a lookup table scheme to generate sinusoids. A digital integrator (accumulator) generates a phase that is mapped by the lookup table into the output sinusoidal waveform.

### Architecture Overview

To understand the DDS Compiler, it is necessary to know how the block is implemented in FPGA hardware. The following is a block diagram of the DDS Compiler core. The core consists of two main parts, a Phase Generator part and a SIN/COS LUT part. These parts can be used independently or together with an optional dither generator to create a DDS capability. A time-division multi-channel capability is supported with independently configurable phase increment and offset parameters

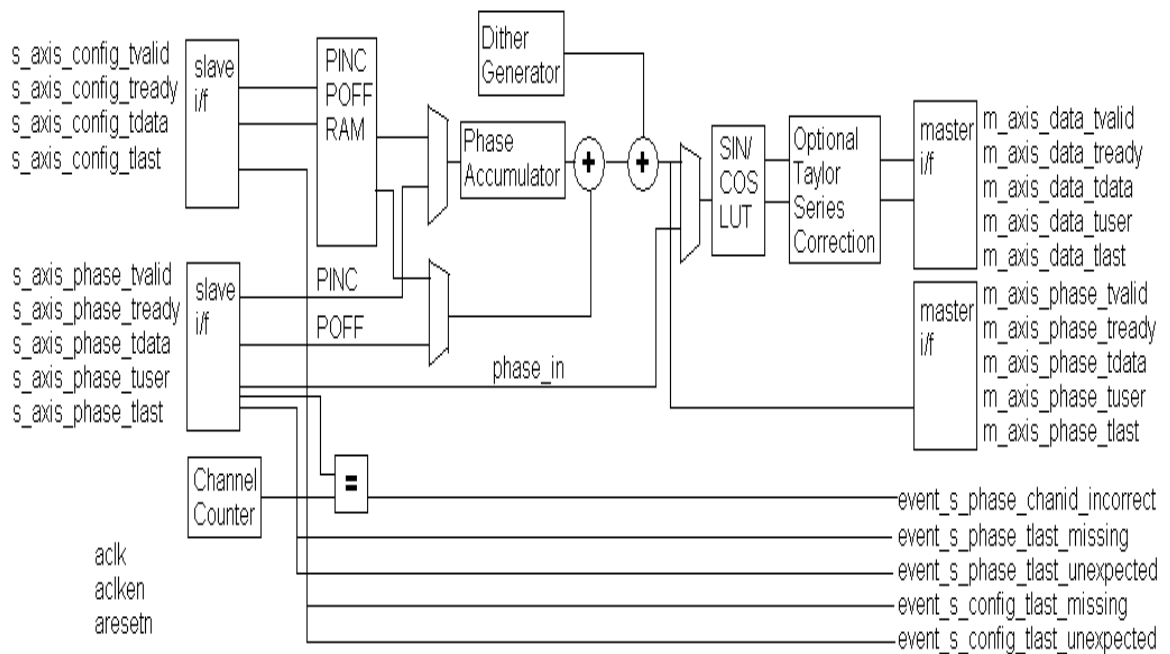

### Phase Generator

The Phase Generator consists of an accumulator followed by an optional adder to provide the addition of a phase offset. When the core is customized, the phase increment and offset can be independently configured to be either fixed, programmable or supplied by the **pinc\_in** and **poff\_in** input ports respectively.

When set to programmable, registers are implemented with a bus interface consisting of **addr**, **reg\_select**, **we**, and **data** signals. The address input, **addr**, specifies the channel for which data is to be written when in multi-channel mode, with **reg\_select** specifying whether data is phase increment or offset.

When set to fixed, the DDS output frequency is set when the core is customized and the frequency cannot be adjusted once the core is embedded in a design.

When used in conjunction with the SIN/COS LUT, an optional dither generator can be configured to provide increased SFDR at the expense of an increased noise floor.

## SIN/COS LUT

The SIN/COS LUT transforms the phase generator output into a **sine** and **cosine** output. Efficient memory usage is achieved using halfwave and quarterwave storage schemes. The presence of both outputs and their negation are configurable when the core is customized. Precision can be increased using optional Taylor Series Correction. This exploits XtremeDSP slices on FPGA families that support them to achieve high SFDR with high speed operation.

## Block Interface



Port functions on the DDS Compiler 4.0 block are as follows:

### Input Ports

- **we**: write enable (active high). Enables a write operation to the offset frequency memory and/or the programmable frequency memory. Which memory is written to is determined by the **reg\_select** port value. Maps to the **we** port on the underlying LogiCORE.
- **reg\_select**: Address select for writing to the phase increment (PINC) memory and the phase offset (POFF) memory. When **reg\_select**=0, the **pinc** memory is selected. When **reg\_select** =1, the **POFF** memory is selected. This port only appears when Phase Increment and Phase Offset are Programmable.
- **addr**: this bus is used to address up to 16 channels for the currently selected memory. The number of bits in **addr** is 1 for 2 channels, 2 for 3 or 4 channels, 3 for 5 to 8 channels, and 4 for 9 to 16.
- **data**: time-shared data bus. The data port is used for supplying values to the programmable phase increment memory or programmable phase offset memory. The input value describes a phase angle. This input can be an unsigned or signed purely fractional quantity. When supplying the phase increment or phase offset, the phase is entered as a fraction of a cycle; that is, for an 18-bit phase, the types are **UFix 18.18** or **Fix 18.18**, which relates to the ranges  $0 \leq \text{phase} < 1.0$  or  $-0.5 \leq \text{phase} < 0.5$  respectively. In the case of phase increment, the fraction supplied is also the output frequency relative to the rate at which the core is clocked per channel; that is, the rate at which the core is clocked divided by the number of channels.
- **rst**: synchronous reset. When '1', the internal memories of the block are reset. (POFF and PINC memories are not reset.) Maps to the **SCLR** (synchronous clear) input on the underlying LogiCORE.
- **en**: user enable. When '1', the block is active. Maps to the **CE** port on the underlying LogiCORE. (Does not apply to POFF and PINC memory write.)



- **phase\_in**: used when the DDS Compiler is configured as SIN\_COS\_LUT\_only. This is the phase input to replace the phase signal created by the Phase Generator. This input is either an unsigned or signed purely fractional quantity and provides the phase as a fraction of a cycle.
- **pinc\_in**: streaming input for Phase Increment. This input allows for easy modulation of the DDS output frequency. This input is either an unsigned or signed purely fractional quantity and supplies the phase increment as a fraction of a cycle. This is also the output frequency as a fraction of the rate at which the core is clocked per channel.
- **poff\_in**: streaming input for Phase Offset. This input allows easy modulation of the DDS output phase. This input is either an unsigned or signed fractional quantity and provides the phase offset as a fraction of a cycle.

### Output Ports

- **rdy**: output data ready - active High. Indicates when the output samples are valid.
- **rfd**: ready for data - active High. **rfd** is a dataflow control signal present on many Xilinx LogiCOREs. In the context of the DDS, it is supplied only for consistency with other LogiCORE cores. This optional port is always tied to VCC.
- **channel**: Channel index. Indicates which channel is currently available at the output when the underlying core is configured for multi-channel operation. This is an unsigned number. It's width is determined by the number of channels that are specified by the **Number of Channels** parameter on the Basic tab.
- **sine**: sine output value. Maps to the SINE output on the underlying LogiCORE.
- **cosine**: cosine output value. Maps to the COSINE output on the underlying LogiCORE.
- **phase\_out**: appears when the Phase\_Generator\_only option is selected. This output is optional on all other variants.

## Block Parameters

The block parameters dialog box can be invoked by double-clicking the icon in your Simulink model.

### Basic tab

Parameters specific to the Basic tab are as follows:

**Configuration Options:** This parameter allows for two parts of the DDS to be instantiated separately or instantiated together. Select one of the following:

- **Phase\_Generator\_and\_SIN\_COS\_LUT**
- **SIN\_COS\_LUT\_only**
- **Phase\_Generator\_only**

### System Requirements

- ◆ **System Clock (Mhz):** Specifies the frequency at which the block is clocked for the purposes of making architectural decisions and calculating phase increment from the specified output frequency. This is a fixed ratio off the System Clock.
- ◆ **Number of Channels:** The channels are time-multiplexed in the DDS which affects the effective clock per channel. The DDS can support 1 to 16 time-multiplexed channels.

Parameter Selection: Choose **System\_Parameters** or **Hardware\_Parameters**

### System Parameters

- ◆ **Spurious Free Dynamic Range (dB):** The targeted purity of the tone produced by the DDS. This sets the output width as well as internal bus widths and various implementation decisions.
- ◆ **Frequency Resolution (Hz):** This sets the precision of the PINC and POFF values. Very precise values will require larger accumulators. Less precise values will cost less in hardware resource.

**Noise Shaping:** Choose one - None, Phase\_Dithering, Taylor\_Series\_Corrected, or Auto.

If the Configuration Options selection is SIN\_COS\_LUT\_only, then None and Taylor\_Series\_Corrected are the only valid options for Noise Shaping. If Phase\_Generator\_Only is selected, then None is the only valid choice for Noise Shaping.

Hardware Parameters

- ◆ **Phase Width:** Equivalent to frequency resolution, this sets the width of the internal phase calculations.
- ◆ **Output Width:** Broadly equivalent to SFDR, this sets the output precision and the minimum Phase Width allowable. However, the output accuracy is also affected by the choice of Noise Shaping.

**Output Selection:** specifies the function(s) that the block will calculate; **Sine**, **Cosine**, or both **Sine\_and\_Cosine**.

Polarity

- ◆ **Negative Sine:** negates the **sine** output.
- ◆ **Negative Cosine:** negates the **cosine** output.

Amplitude Mode

- **Full\_Range:** Selects the maximum possible amplitude.
- **Unit\_Circle:** Selects an exact power-of-two amplitude, which is about one half the Full\_Range amplitude.

**Use explicit period:** When checked, the DDS Compiler 4.0 uses the explicit sample period that is specified in the dialog entry box below.

## Implementation tab

Implementation Options

- ◆ **Memory Type:** Choose between Auto, Distributed\_ROM, or Block\_ROM.
- ◆ **Optimization Goal:** Choose between Auto, Area, or Speed.
- **DSP48 Use:** Choose between Minimal and Maximal. When set to Maximal, XtremeDSP slices are used to achieve to maximum performance.

Latency Options

- ◆ **Auto:** The DDS is fully pipelined for optimal performance.
- ◆ **Configurable:** Allows you to specify less pipeline stages in the **Latency** pulldown menu below. This generally results in less resources consumed.

Optional Pins

- ◆ **Has phase out:** When checked the DDS will have the **phase\_output** port. This is an output of the Phase\_Generator half of the DDS, so it precedes the **sine** and **cosine** outputs by the latency of the sine/cosine lookup table.

- ◆ **rfd**: When checked, the DDS will have an **rfd** port. This is for completeness. The DDS is always ready for **data**, **pinc\_in** and **poff\_in**.
- ◆ **rdy**: When checked, the DDS will have the **rdy** output port which validates the **sine** and **cosine** outputs.
- ◆ **Channel Pin**: When selected, the DDS Compiler will have a **channel** (output) port which qualifies the channel to which the **sine** and/or **cosine** port outputs belong.

### Output Frequency tab

- **Phase Increment Programmability**: specifies the phase increment to be **Fixed**, **Programmable** or **Streaming**. The choice of Programmable adds channel, data, and we input ports to the block.

The following fields are activated when Phase\_Generator\_and\_SIN\_COS\_LUT is selected as the Configuration Options field on the Basic tab, the Parameter Selection on the Basic tab is set to Hardware Parameters and Phase Increment Programmability field on the Phase Offset Angles tab is set to **Fixed** or **Programmable**.

- ◆ **Output frequencies (Mhz)**: for each channel, an independent frequency can be entered into an array. This field is activated when Parameter Selection on the Basic tab is set to **System Parameters** and Phase Increment Programmability is **Fixed** or **Programmable**.
- ◆ **Phase Angle Increment Values**: This field is activated when Phase\_Generator\_and\_SIN\_COS\_LUT is selected as the Configuration Options field on the Basic tab, the Parameter Selection on the Basic tab is set to **Hardware Parameters** and Phase Increment Programmability field on the Phase Offset Angles tab is set to **Fixed** or **Programmable**. Values must be entered in binary. The range is 0 to the weight of the accumulator, for example,  $2^{\text{Phase\_Width}-1}$ .

### Phase Offset Angles tab

- **Phase Offset Programmability**: specifies the phase offset to be **None**, **Fixed**, **Programmable** or **Streaming**. The choice of Fixed or Programmable adds the channel, data, and we input ports to the block.
- ◆ **Phase Offset Angles (x2pi radians)**: for each channel, an independent offset can be entered into an array. The entered values are multiplied by  $2\pi$  radians. This field is activated when Parameter Selection on the Basic tab is set to **System Parameters** and Phase Increment Programmability is **Fixed** or **Programmable**.
- ◆ **Phase Angle Offset Values**: for each channel, an independent offset can be entered into an array. The entered values are multiplied by  $2\pi$  radians. This field is activated when Parameter Selection on the Basic tab is set to **Hardware Parameters** and Phase Increment Programmability is **Fixed** or **Programmable**.

Other parameters used by this block are explained in the topic [Common Options in Block Parameter Dialog Boxes](#).

## LogiCORE™ Documentation

[LogiCORE IP DDS Compiler v4.0](#)

## Device Support

Virtex-7 and Kintex-7, Virtex-6, Virtex-5, Virtex-4,  
Spartan-6, Spartan-3/XA, Spartan-3E/XA, Spartan-3A/3AN/3A DSP/XA

## DDS Compiler 5.0

This block is listed in the following Xilinx Blockset libraries: AXI4, DSP and Index.

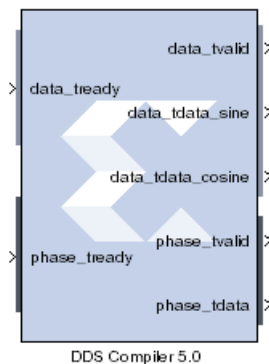

The Xilinx DDS (Direct Digital Synthesizer) Compiler 5.0 block implements high performance, optimized Phase Generation and Phase to Sinusoid circuits with AXI4-Stream compliant interfaces for Virtex-6, Spartan-6, Virtex-7 and Kintex-7 devices.

The core sources sinusoidal waveforms for use in many applications. A DDS consists of a Phase Generator and a SIN/COS Lookup Table (phase to sinusoid conversion). These parts are available individually or combined using this core.

Refer to the topic [AXI Interface](#) for more detailed information on the AXI Interface.

### Architecture Overview

To understand the DDS Compiler, it is necessary to know how the block is implemented in FPGA hardware. The following is a block diagram of the DDS Compiler core. The core consists of two main parts, a Phase Generator part and a SIN/COS LUT part. These parts can be used independently or together with an optional dither generator to create a DDS capability. A time-division multi-channel capability is supported with independently configurable phase increment and offset parameters

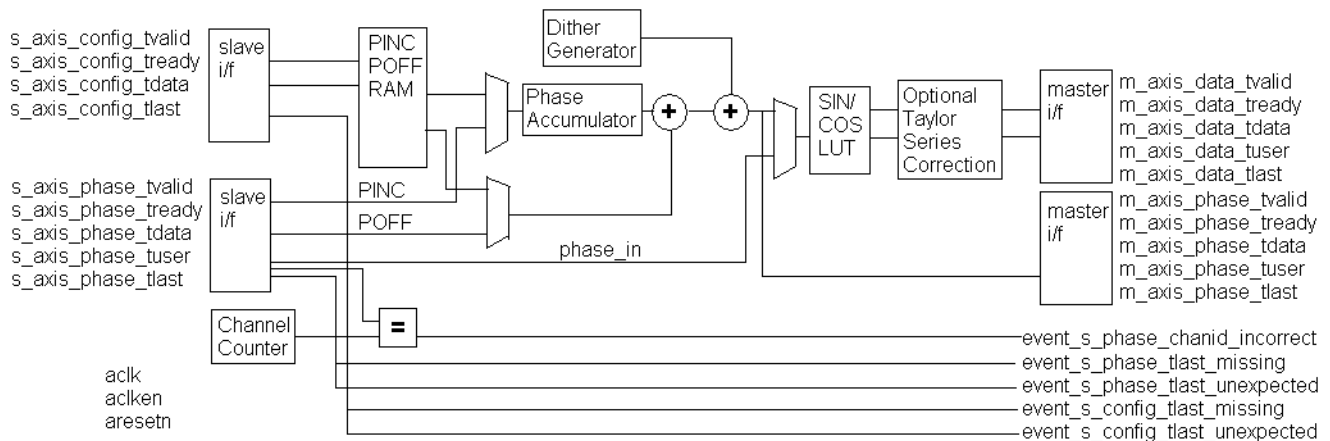

### Phase Generator

The Phase Generator consists of an accumulator followed by an optional adder to provide addition of phase offset. When the core is customized the phase increment and offset can be independently configured to be either fixed, programmable (using the CONFIG channel) or dynamic (using the input PHASE channel).

When set to fixed the DDS output frequency is set when the core is customized and cannot be adjusted once the core is embedded in a design.

When set to programmable, the CONFIG channel TDATA field will have a subfield for the input in question (PINC or POFF) or both if both have been selected to be programmable. If neither PINC nor POFF is set to programmable, there is no CONFIG channel.

When set to streaming, the input PHASE channel TDATA port (s\_axis\_phase\_tdata) will have a subfield for the input in question (PINC or POFF) or both if both have been selected to be streaming. If neither PINC nor POFF is set to streaming, and the DDS is configured to have a Phase Generator then there is no input PHASE channel. Note that when the DDS is configured to be a SIN/COS Lookup only, the PHASE\_IN field is input using the input PHASE channel TDATA port.

### SIN/COS LUT

When configured as a SIN/COS Lookup only, the Phase Generator is not implemented, and the PHASE\_IN signal is input using the input PHASE channel, and transformed into the SINE and COSINE outputs using a look-up table.

Efficient memory usage is achieved by exploiting the symmetry of sinusoid waveforms. The core can be configured for SINE only output, COSINE only output or both (quadrature) output. Each output can be configured independently to be negated. Precision can be increased using optional Taylor Series Correction. This exploits XtremeDSP slices on FPGA families that support them to achieve high SFDR with high speed operation.

### AXI Ports that are Unique to this Block

Depending on the Configuration Options and Phase Increment/Offset Programmability options selected, different subfield-ports for the PHASE channel or the CONFIG channel (or both channels) are available on the block, as described in the table below.

Configuration Option	Phase Increment Programmability		Phase Offset Programmability	
	Option Selected	Available Port	Option Selected	Available Port
Phase_Generator_only Phase_Generator_and_SIN_ COS_LUT	Programmable	s_axis_config_tdata_pinc	Programmable	s_axis_config_tdata_poff
	Streaming	s_axis_phase_tdata_pinc	Streaming	s_axis_phase_tdata_poff
	Fixed	NA	Fixed	NA
None			NA	
SIN_COS_LUT_only	In this configuration, input port s_axis_phase_tdata_phase_in are available			

### Block Parameters

The block parameters dialog box can be invoked by double-clicking the icon in your Simulink model.

#### Basic tab

Parameters specific to the Basic tab are as follows:

**Configuration Options:** This parameter allows for two parts of the DDS to be instantiated separately or instantiated together. Select one of the following:

- **Phase\_Generator\_and\_SIN\_COS\_LUT**
- **Phase\_Generator\_only**
- **SIN\_COS\_LUT\_only**

### System Requirements

- **System Clock (Mhz):** Specifies the frequency at which the block is clocked for the purposes of making architectural decisions and calculating phase increment from the specified output frequency. This is a fixed ratio off the System Clock.
- **Number of Channels:** The channels are time-multiplexed in the DDS which affects the effective clock per channel. The DDS can support 1 to 16 time-multiplexed channels.

Parameter Selection: Choose **System\_Parameters** or **Hardware\_Parameters**

### System Parameters

- **Spurious Free Dynamic Range (dB):** The targeted purity of the tone produced by the DDS. This sets the output width as well as internal bus widths and various implementation decisions.
- **Frequency Resolution (Hz):** This sets the precision of the PINC and POFF values. Very precise values will require larger accumulators. Less precise values will cost less in hardware resource.

**Noise Shaping:** Choose one - **None**, **Phase\_Dithering**, **Taylor\_Series\_Corrected**, or **Auto**.

If the Configuration Options selection is **SIN\_COS\_LUT\_only**, then **None** and **Taylor\_Series\_Corrected** are the only valid options for Noise Shaping. If **Phase\_Generator\_Only** is selected, then **None** is the only valid choice for Noise Shaping.

### Hardware Parameters

- **Phase Width:** Equivalent to frequency resolution, this sets the width of the internal phase calculations.
- **Output Width:** Broadly equivalent to SFDR, this sets the output precision and the minimum Phase Width allowable. However, the output accuracy is also affected by the choice of Noise Shaping.

### Output Selection

- **Sine\_and\_Cosine:** Place both a Sine and Cosine output port on the block.
- **Sine:** Place only a Sine output port on the block.
- **Cosine:** Place only a Cosine output port on the block.

### Polarity

- ◆ **Negative Sine:** negates the **sine** output.
- ◆ **Negative Cosine:** negates the **cosine** output.

### Amplitude Mode

- **Full\_Range:** Selects the maximum possible amplitude.
- **Unit\_Circle:** Selects an exact power-of-two amplitude, which is about one half the Full\_Range amplitude.

## Implementation tab

### Implementation Options

- **Memory Type:** Choose between **Auto**, **Distributed\_ROM**, or **Block\_ROM**.
- **Optimization Goal:** Choose between **Auto**, **Area**, or **Speed**.
- **DSP48 Use:** Choose between **Minimal** and **Maximal**. When set to **Maximal**, XtremeDSP slices are used to achieve to maximum performance.

### Latency Options

- **Auto:** The DDS is fully pipelined for optimal performance.
- **Configurable:** Allows you to specify less pipeline stages in the **Latency** pulldown menu below. This generally results in less resources consumed.

### Control Signals

- **Has phase out:** When checked the DDS will have the **phase\_output** port. This is an output of the Phase\_Generator half of the DDS, so it precedes the **sine** and **cosine** outputs by the latency of the sine/cosine lookup table.
- **ACLKEN:** Enables the clock enable (aclken) pin on the core. All registers in the core are enabled by this control signal.
- **ARESETn:** Active-low synchronous clear input that always takes priority over ACLKEN. A minimum ARESETn active pulse of two cycles is required, since the signal is internally registered for performance. A pulse of one cycle resets the core, but the response to the pulse is not in the cycle immediately following.

### Explicit Sample Period

- **Use explicit period:** When checked, the DDS Compiler block uses the explicit sample period that is specified in the dialog entry box below.

## AXI Channel Options tab

### AXI Channel Options

#### TLAST

Enabled when there is more than one DDS channel (as opposed to AXI channel), as TLAST is used to denote the transfer of the last time-division multiplied channel of the DDS. Options are:

- **Not\_Required:** In this mode, no TLAST appears on the input PHASE channel nor on the output channels.
- **Vector\_Framing:** In this mode, TLAST on the input PHASE channel and output channels denotes the last.
- **Packet\_Framing:** In this mode, TLAST is conveyed from the input PHASE channel to the output channels with the same latency as TDATA. The DDS does not use or interpret the TLAST signal in this mode. This mode is intended as a service to ease system design for cases where signals must accompany the datastream, but which have no application in the DDS.
- **Config\_Triggered:** This is an enhanced variant of the Vector Framing option. In this option, the TLAST on the input PHASE channel can trigger the adoption of new configuration data from the CONFIG channel when there is new configuration data available. This allows the re-configuration to be synchronized with the cycle of time-division-multiplexed DDS channels.

#### TREADY

- ◆ **Output TREADY:** When selected, the output channels will have a TREADY and hence support the full AXI handshake protocol with inherent back-pressure. If there is an input PHASE channel, its TREADY is also determined by this control, so that the datapath from input PHASE channel to output channels as a whole supports backpressure or not.

#### TUSER Options

Select one of the following options for the **Input, DATA Output, and PHASE Output**.

- **Not\_Required:** Neither of the above uses is required; the channel in question will not have a TUSER field.
- **Chan\_ID\_Field:** In this mode, the TUSER field identifies the time-division-multiplexed channel for the transfer.
- **User\_Field:** In this mode, the block ignores the content of the TUSER field, but passes the content untouched from the input PHASE channel to the output channels.
- **User and Chan\_ID\_Field:** In this mode, the TUSER field will have both a user field and a chan\_id field, with the chan\_id field in the least significant bits. The minimal number of bits required to describe the channel will determine the width of the chan\_id field, e.g. 7 channels will require 3 bits.
- **User Field Width:** This field determines the width of the bit field which is conveyed from input to output untouched by the DDS.

#### Config Channel Options

- Synchronization Mode
  - ◆ **On\_Vector:** In this mode, the re-configuration data is applied when the channel starts a new cycle of time-division-multiplexed channels.
  - ◆ **On\_Packet:** In this mode, available when TLAST is set to packet framing, the TLAST channel will trigger the re-configuration. This mode is targeted at the case where it is to be associated with the packets implied by the input TLAST indicator.

#### Output Frequency tab

- **Phase Increment Programmability:** specifies the phase increment to be **Fixed, Programmable** or **Streaming**. The choice of Programmable adds channel, data, and we input ports to the block.

The following fields are activated when Phase\_Generator\_and\_SIN\_COS\_LUT is selected as the Configuration Options field on the Basic tab, the Parameter Selection on the Basic tab is set to Hardware Parameters and Phase Increment Programmability field on the Phase Offset Angles tab is set to **Fixed** or **Programmable**.

- ◆ **Output frequencies (Mhz):** for each channel, an independent frequency can be entered into an array. This field is activated when Parameter Selection on the Basic tab is set to **System Parameters** and Phase Increment Programmability is **Fixed** or **Programmable**.
- ◆ **Phase Angle Increment Values:** This field is activated when Phase\_Generator\_and\_SIN\_COS\_LUT is selected as the Configuration Options field on the Basic tab, the Parameter Selection on the Basic tab is set to **Hardware Parameters** and Phase Increment Programmability field on the Phase Offset Angles tab is set to **Fixed** or **Programmable**. Values must be entered in binary. The range is 0 to the weight of the accumulator, for example,  $2^{\text{Phase\_Width}-1}$ .



### Phase Offset Angles tab

- Phase Offset Programmability:** specifies the phase offset to be **None**, **Fixed**, **Programmable** or **Streaming**. The choice of Fixed or Programmable adds the channel, data, and we input ports to the block.
  - Phase Offset Angles (x2pi radians):** for each channel, an independent offset can be entered into an array. The entered values are multiplied by  $2\pi$  radians. This field is activated when Parameter Selection on the Basic tab is set to **System Parameters** and Phase Increment Programmability is **Fixed** or **Programmable**.
  - Phase Angle Offset Values:** for each channel, an independent offset can be entered into an array. The entered values are multiplied by  $2\pi$  radians. This field is activated when Parameter Selection on the Basic tab is set to **Hardware Parameters** and Phase Increment Programmability is **Fixed** or **Programmable**.

### Advanced tab

#### Block Icon Display

- Display shortened port names:** this option is ON by default. When unselected, the full AXI name of each port is displayed on the block.

Other parameters used by this block are explained in the topic [Common Options in Block Parameter Dialog Boxes](#).

### How to Migrate from DDS Compiler 4.0 to DDS Compiler 5.0

#### Design Description

This example shows how to migrate from the non-axi DDS Compiler block to AXI4 DDS Compiler block using the same or similar block parameters. Some of the parameters between non-AXI and AXI4 versions might not be identical exactly due to some changes in certain features and block interfaces. The following model is used to illustrate the design migration between these block. For more detail, refer to the datasheet of this IP core.

#### Example showing how to migrate to AXI4 DDS Compiler IP block

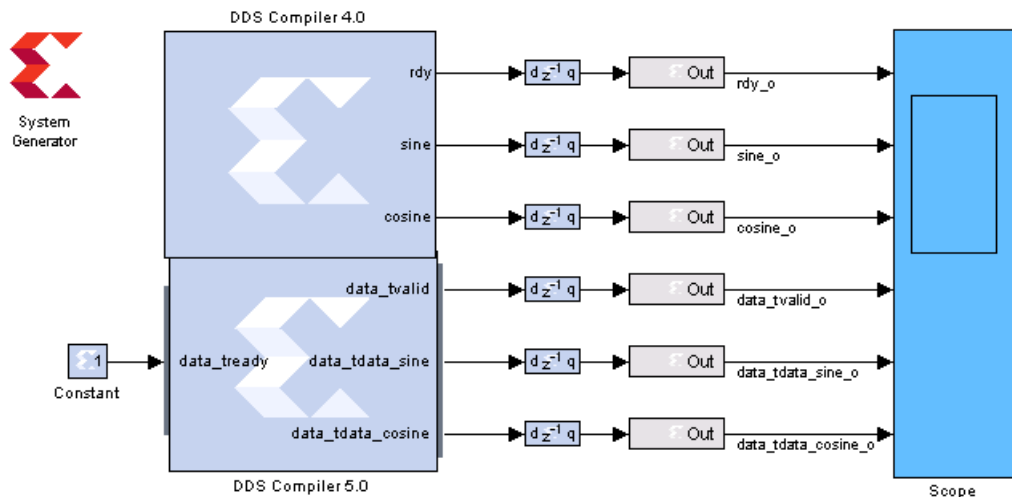

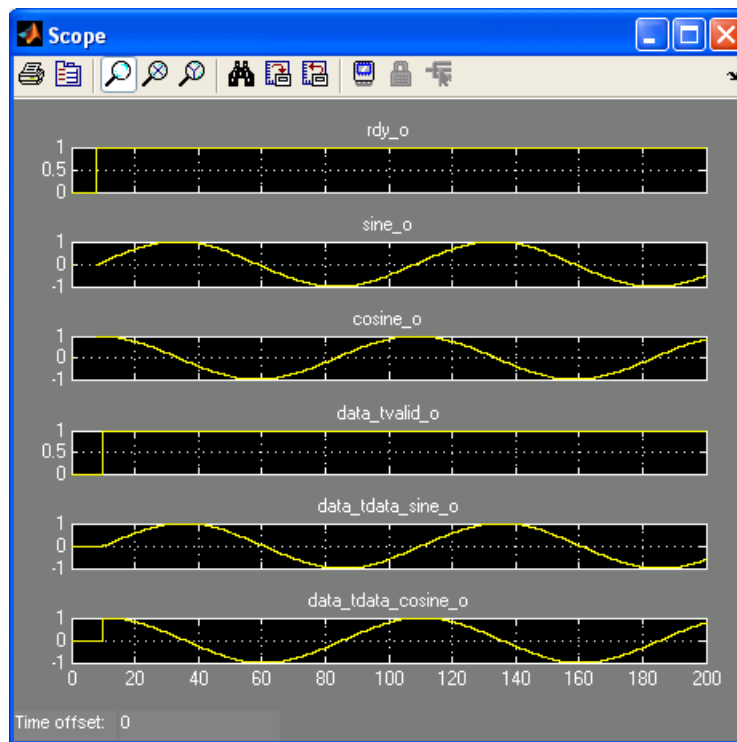

#### Data Path and Control Signals:

Both versions have similar data paths and control signals. The “rdy” output signal is replaced by the “data\_tvalid” output signal. As shown by the simulation, these two control signals have the same active high when outputs are valid. However, the propagation delay might not be the same and a delay block might be required depending on your specific design applications.

data\_tvalid (Master): can be used to drive other input Slave tvalid signal.

data\_tready (Slave): are not used and being connected to a constant of one.

## LogiCORE™ Documentation

[LogiCORE IP DDS Compiler v5.0](#)

## Device Support

Virtex-7 and Kintex-7, Virtex-6, Spartan-6

## Delay

This block is listed in the following Xilinx Blockset libraries: *Basic Elements, Floating-Point, Memory, and Index.*

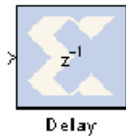

The Xilinx Delay block implements a fixed delay of  $L$  cycles.

The delay value is displayed on the block in the form  $z^{-L}$ , which is the *Z-transform* of the block's transfer function. Any data provided to the input of the block will appear at the output after  $L$  cycles. The rate and type of the data of the output is inherited from the input. This block is used mainly for matching pipeline delays in other portions of the circuit. The delay block differs from the register block in that the register allows a latency of only 1 cycle and contains an initial value parameter. The delay block supports a specified latency but no initial value other than zeros. The figure below shows the **Delay** block behavior when  $L=4$  and **Period=1s**.

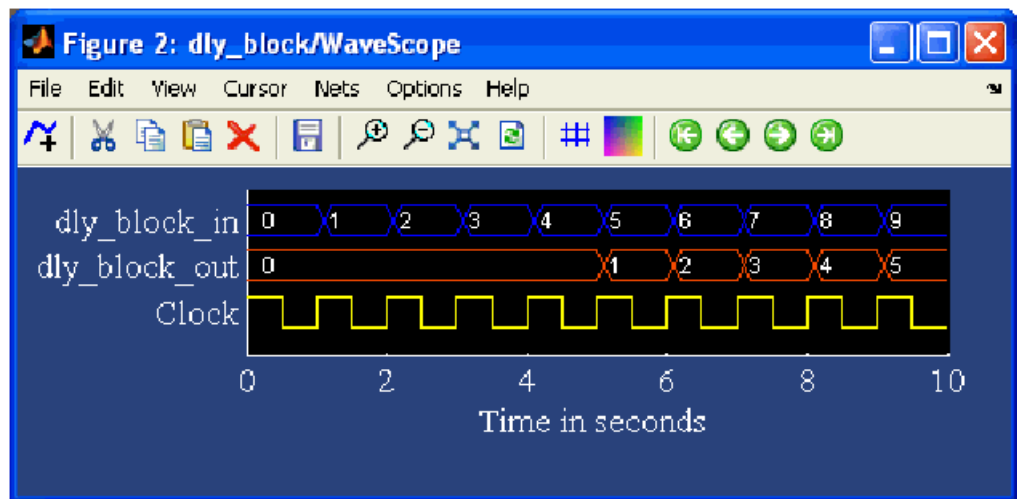

For delays that need to be adjusted during run-time, you should use the **Addressable Shift Register** block. Delays that are not an integer number of clock cycles are not supported and such delays should not be used in synchronous design (with a few rare exceptions).

### Block Parameters

The block parameters dialog box can be invoked by double-clicking the icon in your Simulink model.

#### Basic tab

Parameters specific to the Basic tab are as follows:

- **Provide synchronous reset port:** this option activates an optional reset (rst) pin on the block. When the reset signal is asserted the block goes back to its initial state. Reset signal has precedence over the optional enable signal available on the block. The reset signal has to run at a multiple of the block's sample rate. The signal driving the reset port must be Boolean.
- **Provide enable port:** this option activates an optional enable (en) pin on the block. When the enable signal is not asserted the block holds its current state until the enable signal is asserted again or the reset signal is asserted. Reset signal has precedence over the enable signal. The enable signal has to run at a multiple of the block's sample rate. The signal driving the enable port must be Boolean.

- **Latency:** Latency is the number of cycles of delay. The latency can be zero, provided that the **Provide enable port** checkbox is not checked. The latency must be a non-negative integer. If the latency is zero, the delay block collapses to a wire during logic synthesis. If the latency is set to  $L=1$ , the block will generally be synthesized as a flip-flop (or multiple flip-flops if the data width is greater than 1).

## Implementation tab

Parameters specific to the Implementation tab are as follows:

- **Implement using behavioral HDL:** uses behavioral HDL as the implementation. This allows the downstream logic synthesis tool to choose the best implementation.

Other parameters used by this block are explained in the topic [Common Options in Block Parameter Dialog Boxes](#).

## Logic Synthesis using Behavioral HDL

This setting is recommended if you are using Synplify Pro as the downstream logic synthesis tool. The logic synthesis tool will implement the delay as it desires, performing optimizations such as moving parts of the delay line back or forward into blockRAMs, DSP48s, or embedded IOB flip-flops; employing the dedicated SRL cascade outputs for long delay lines based on the architecture selected; and using flip-flops to terminate either or both ends of the delay line based on path delays. Using this setting also allows the logic synthesis tool, if sophisticated enough, to perform retiming by moving portions of the delay line back into combinational logic clouds.

## Logic Synthesis using Structural HDL

If you do not check the box **Implement using behavioral HDL**, then structural HDL is used. This is the default setting and results in a known, but less-flexible, implementation which is often better for use with XST. In general, this setting produces structural HDL comprising an SRL (Shift-Register LUT) delay of  $(L-1)$  cycles followed by a flip-flop, with the SRL and the flip-flop getting packed into the same slice. For a latency greater than  $L=17$ , multiple SRL/flip-flop sets are

cascaded, albeit without using the dedicated cascade routes. For example, the following is the synthesis result for a 1-bit wide delay block with a latency of L=32:

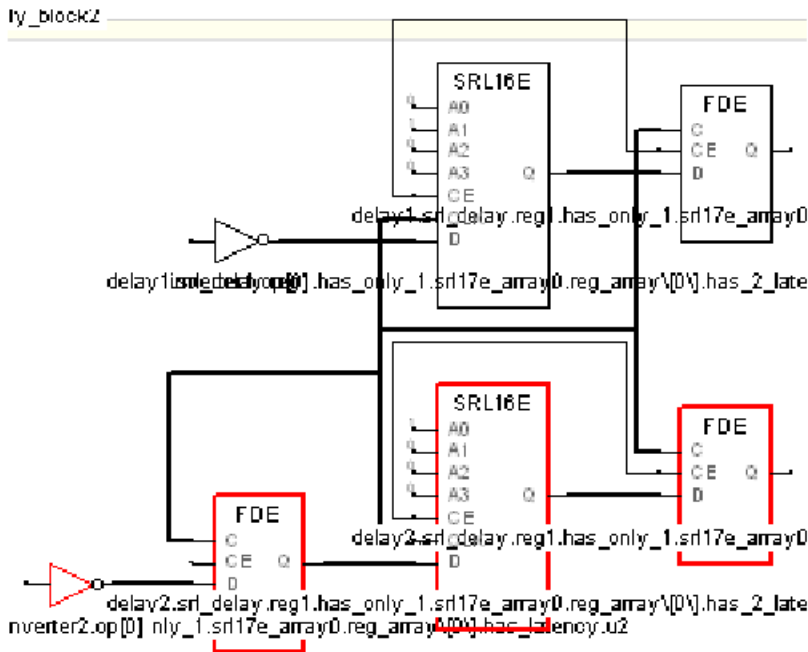

The first SRL provides a delay of 16 cycles and the associated flip-flop adds another cycle of delay. The second SRL provides a delay of 14 cycles; this is evident because the address is set to {A3,A2,A1,A0}=1101 (binary) = 13, and the latency through an SRL is the value of the address plus one. The last flip-flop adds a cycle of delay, making the grand total  $L=16+1+14+1=32$  cycles.

The SRL is an efficient way of implementing delays in the Xilinx architecture. An SRL and its associated flip-flop that comprise a single *logic cell* can implement seventeen cycles of delay whereas a delay line consisting only of flip-flops can implement only one cycle of delay per logic cell.

The SRL has a setup time that is longer than that of a flip-flop. Therefore, for very fast designs with a combinational path preceding the delay block, it can be advantageous, when using the structural HDL setting, to precede the delay block with an additional delay block with a latency of L=1. This

ensures that the critical path is not burdened with the long setup time of the SRL. An example is shown below.

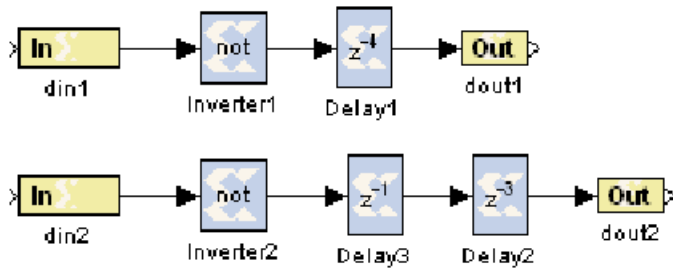

These designs are logically equivalent, but the bottom one will have a faster hardware implementation. The bottom design will have the combinational path formed by *Inverter2* terminated by a flipflop, which has a shorter setup time than an SRL.

The synthesis results of both designs are shown below, with the faster design highlighted in red:

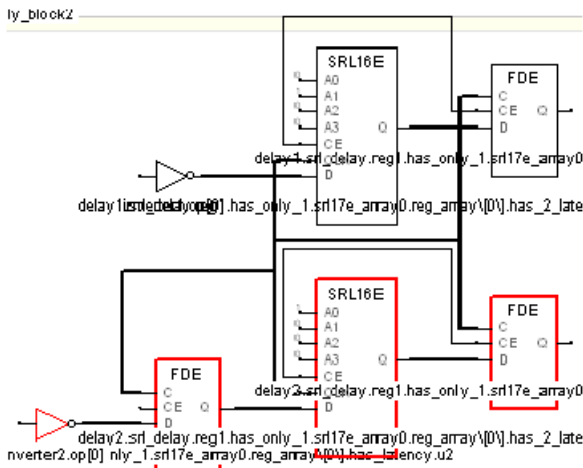

Note that an equivalent to the faster design results from setting the latency of *Inverter2* to 1 and eliminating *Delay3*. This, however, is not equivalent to setting the latency of *Inverter2* to 4 and eliminating the delay blocks; this would yield a synthesis equivalent to the upper (slower) design.

## Implementing Long Delays

For very long delays, of, say, greater than 128 cycles, especially when coupled with larger bus widths, it might be better to use a block-RAM-based delay block. The delay block is implemented using SRLs, which are part of the general fabric in the Xilinx. Very long delays should be implemented in the embedded block RAMs to save fabric. Such a delay exploits the dual-port nature of the blockRAM and can be implemented with a fixed or run-time-variable delay. Such a block is basically a block RAM with some associated address counters. The model below shows a novel way of implementing a long delay using LFSRs (linear feedback shift registers) for the address counters in order to make the design faster, but conventional counters can be used as well. The difference in value between the counters (minus the RAM latency) is the latency  $L$  of the delay line.

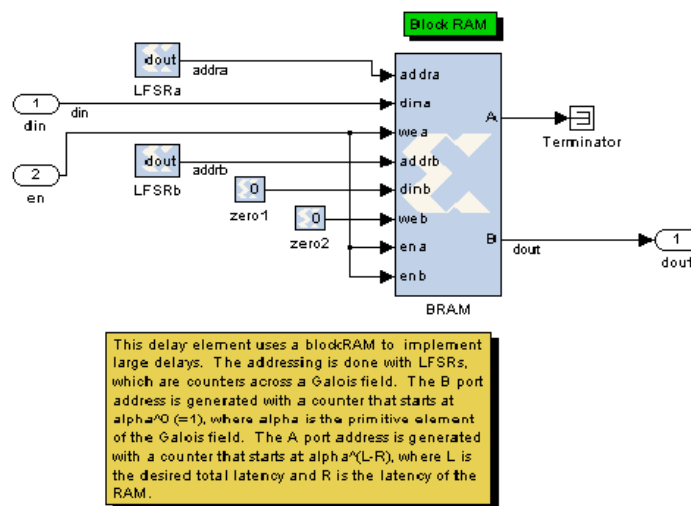

## Re-settable Delays and Initial Values

If a delay line absolutely must be re-settable to zero, this can be done by using a string of  $L$  register blocks to implement the delay or by creating a circuit that forces the output to be zero while the delay line is “flushed”.

The delay block doesn’t support initial values, but the **Addressable Shift Register** block does. This block, when used with a fixed address, is generally equivalent to the delay block and will synthesize to an SRL-based delay line. The initial values pertain to initialization only and not to a reset. If using the addressable shift register in “structural HDL mode” (e.g., the **Use behavioral HDL** checkbox is not selected) then the delay line will not be terminated with a flip-flop, making it significantly slower. This can be remedied by using behavioral mode or by putting a **Register** or **Delay** block after the addressable shift register.

## Device Support

Floating-Point support is restricted to the following devices:

Virtex-7, Kintex-7, Artix-7, Zynq-7000, Virtex-6, Spartan-6



# Depuncture

This block is listed in the following Xilinx Blockset libraries: *Communication and Index*.

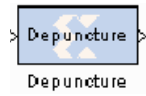

The Xilinx Depuncture block allows you to insert an arbitrary symbol into your input data at the location specified by the depuncture code.

The Xilinx depuncture block accepts data of type  $UFixN_0$  where  $N$  equals the length of insert string  $x$  (the number of ones in the depuncture code) and produces output data of type  $UFixK_0$  where  $K$  equals the length of insert string multiplied by the length of the depuncture code.

The Xilinx Depuncture block can be used to decode a range of punctured convolution codes. The following diagram illustrates an application of this block to implement soft decision Viterbi decoding of punctured convolution codes.

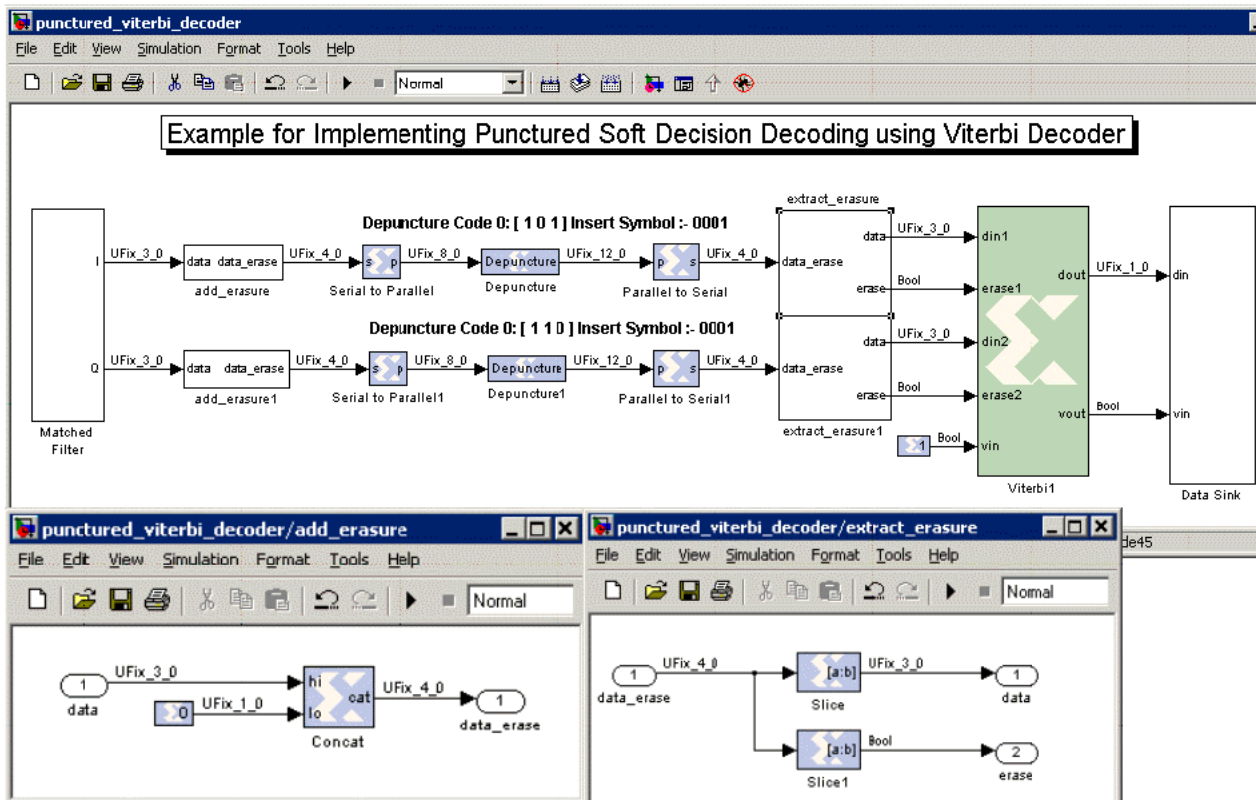

The previous diagram shows a matched filter block connected to a `add_erasure` subsystem which attaches a 0 to the input data to mark it as a non-erasure signal. The output from the `add_erasure` subsystem is then passed to a serial to parallel block. The serial to parallel block concatenates two continuous soft inputs and presents it as an 8-bit word to the depuncture block. The depuncture block inserts the symbol '0001' after the 4-bits from the MSB for code 0 ([1 0 1]) and 8-bits from the MSB for code 1 ([1 1 0]) to form a 12-bit word. The output of the depuncture block is serialized as 4-bit words using the parallel to serial block. The `extract_erasure` subsystem takes the input 4-bit word and extracts 3-bits from the MSB to form a soft decision input data word and 1-bit from the LSB to form the erasure signal for the Viterbi decoder.

## Block Parameters

The block parameters dialog box can be invoked by double-clicking the icon in your Simulink model.

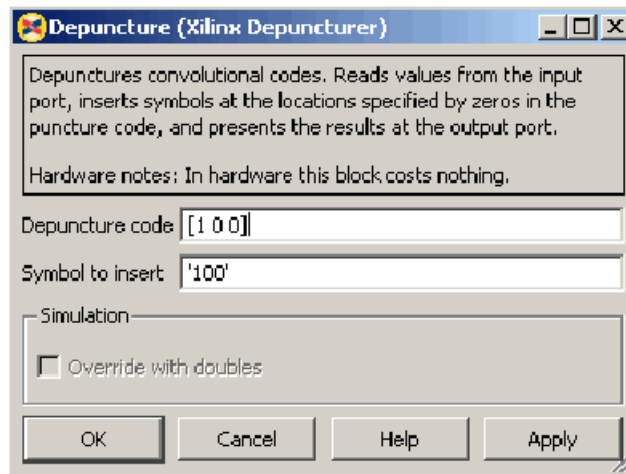

Parameters specific to the Xilinx Depuncturer block are:

- **Depuncture code:** specifies the depuncture pattern for inserting the string to the input.
- **Symbol to insert:** specifies the binary word to be inserted in the depuncture code.

Other parameters used by this block are explained in the topic [Common Options in Block Parameter Dialog Boxes](#).

## Disregard Subsystem

*This block is listed in the following Xilinx Blockset libraries: Tools and Index.*



Disregard Subsystem  
For Generation

This block has been deprecated since System Generator version 6.2.

The block might be eliminated in a future version of System Generator. The functionality supplied by this block is now available through System Generator's support for Simulink's configurable subsystem which is discussed in the topic [Configurable Subsystems and System Generator](#). Configurable subsystems offer several advantages over the Disregard Subsystem block.

The Disregard Subsystem block can be placed into any subsystem of your model to indicate that you do not wish System Generator to generate hardware for that subsystem. This block can be used in combination with the simulation multiplexer block to build alternative simulation models for a portion of a design, for example, to provide a simulation model for a black box.

This block has no parameters.

## Divide

This block is listed in the following Xilinx Blockset libraries: *Floating-Point, Math and Index*.

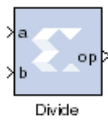

The Xilinx Divide block performs both fixed-point and floating-point division with the **a** input being the dividend and the **b** input the divisor. Both inputs must be of the same data type.

### Basic tab

Parameters specific to the Basic tab are as follows:

AXI Interface

Flow Control:

- **Blocking:** Selects “Blocking” mode. In this mode, the lack of data on one input channel does block the execution of an operation if data is received on another input channel.
- **NonBlocking:** Selects “Non-Blocking” mode. In this mode, the lack of data on one input channel does not block the execution of an operation if data is received on another input channel.

Fixed-point Options

Algorithm Type:

- **Radix2:** This is non-restoring integer division using integer operands and allows a remainder to be generated. This option is recommended for operand widths less than 16 bits. This option supports both unsigned (two's complement) and signed divisor and dividend inputs.
- **High Radix:** This option is recommended for operand widths greater than 16 bits, though the implementation requires the use of DSP48 (or variant) primitives. This option only supports signed (two's complement) divisor and dividend inputs.
- **Output Fractional width:** For Fixed-point division, this entry determines the number of bits in the fractional part of the output. Optional ports

Dividend Channel Ports

- **Has TLAST:** Adds a TLAST port to the Input channel.
- **Has TUSER:** Adds a TUSER port to the Input channel.

Divisor Channel Ports

- **Has TLAST:** Adds a TLAST port to the Input channel.
- **Has TUSER:** Adds a TUSER port to the Input channel.

Control Options

- **Provide enable port:** Adds an enable port to the block interface.
- **Has Result TREADY:** Adds a TREADY port to the Result channel.
- **Output TLAST behavior:** Determines the behavior of the result\_tlast output port.
  - ◆ **Null:** Output is null.
  - ◆ **Pass A\_TLAST:** Pass the value of the a\_tlast input port to the dout\_tlast output port.
  - ◆ **Pass B\_TLAST:** Pass the value of the b\_tlast input port to the dout\_tlast output port.
  - ◆ **Pass CTRL\_TLAST:** Pass the value of the ctrl\_tlast input port to the dout\_tlast output port.

- ◆ **OR\_all\_TLASTS**: Pass the logical OR of all the present TLAST input ports.
- ◆ **AND\_all\_TLASTS**: Pass the logical AND of all the present TLAST input ports.

#### Exception Signals

- **UNDERFLOW**: Adds an output port that serves as an underflow flag.
- **OVERFLOW**: Adds an output port that serves as an overflow flag.
- **INVALID\_OP**: Adds an output port that serves as an invalid operation flag.
- **DIVIDE\_BY\_ZERO**: Adds an output port that serves as a divide-by-zero flag.

Other parameters used by this block are explained in the topic [Common Options in Block Parameter Dialog Boxes](#).

## LogiCORE™ Documentation

[LogiCORE IP Divider Generator 4.0](#)

[LogiCORE IP Floating-Point Operator v6.1](#)

## Device Support

Floating-Point support is restricted to the following devices:

Virtex-7, Kintex-7, Artix-7, Zynq-7000, Virtex-6, Spartan-6

## Divider Generator 3.0

This block is listed in the following Xilinx Blockset libraries: *DSP, Math, and Index*.

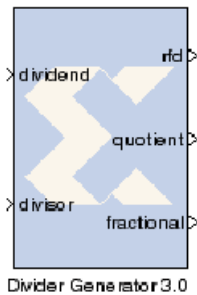

The Xilinx Divider Generator 3.0 block creates a circuit for integer division based on Radix-2 non-restoring division, or High-Radix division with prescaling.

### Block Parameters

The block parameters dialog box can be invoked by double-clicking the icon in your Simulink model.

#### Basic tab

Parameters specific to the Basic tab are:

##### Common Options

- **Dividend and quotient width:** (integer) 2 to 32 (Radix-2). 2 to 54 (High Radix). Specifies the width of both dividend and quotient.
- **Divisor width:** (integer): 2 to 32 (Radix-2). 2 to 54 (High Radix).
- **Algorithm Type:**
  - ◆ **Radix-2** non-restoring integer division using integer operands, allows a remainder to be generated. This is recommended for operand widths less than around 16 bits. This option supports both **unsigned** and **signed** (2's complement) divisor and dividend inputs.
  - ◆ **High Radix** division with prescaling. This is recommended for operand widths greater than 16 bits, though the implementation requires the use of DSP48 (or variant) primitives. This option only supports **signed** (2's complement) divisor and dividend inputs.
- **Remainder type:**
  - ◆ **Remainder:** Only supported for Radix 2.
  - ◆ **Fractional:** Determines the number of bits in the fractional port output.
- **Fractional Width:** If Fractional Remainder type is selected, this entry determines the number of bits in the fractional port output.

##### Radix2 Options

- **Clocks per division:** Determines the interval in clocks between new data being input (and output).

##### High Radix Options

- **Detect divide by zero:** Determines if the core shall have a division-by-zero indication output port.
- **Latency configuration:** *Automatic* (fully pipelined) or *Manual* (determined by following field).

- **latency:** This field determines the exact latency from input to output in terms of clock enabled clock cycles.

#### Optional Ports

- **en:** Add enable port
- **rst:** Add reset port.

Other parameters used by this block are explained in the topic [Common Options in Block Parameter Dialog Boxes](#).

## LogiCORE™ Documentation

[LogiCORE IP Divider Generator 3.0](#)

## Device Support

Virtex-7, Kintex-7, Virtex-6, Virtex-5, Virtex-4,  
Spartan-6, Spartan-3/XA, Spartan-3E/XA, Spartan-3A/3AN/3A DSP/XA

## Divider Generator 4.0

This block is listed in the following Xilinx Blockset libraries: AXI4, DSP, Math, and Index.

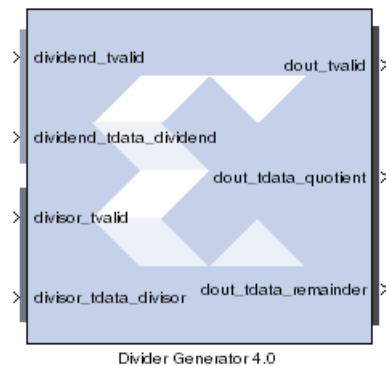

The Xilinx Divider Generator 4.0 block creates a circuit for integer division based on Radix-2 non-restoring division, or High-Radix division with prescaling.

### Block Parameters

The block parameters dialog box can be invoked by double-clicking the icon in your Simulink model.

#### Basic tab

Parameters specific to the Basic tab are:

##### Common Options

- **Algorithm Type:**
  - ◆ **Radix-2** non-restoring integer division using integer operands, allows a remainder to be generated. This is recommended for operand widths less than around 16 bits. This option supports both **unsigned** and **signed** (2's complement) divisor and dividend inputs.
  - ◆ **High Radix** division with prescaling. This is recommended for operand widths greater than 16 bits, though the implementation requires the use of DSP48 (or variant) primitives. This option only supports **signed** (2's complement) divisor and dividend inputs.

##### Output channel

- **Remainder type:**
  - ◆ **Remainder:** Only supported for Radix 2.
  - ◆ **Fractional:** Determines the number of bits in the fractional port output.
- **Fractional width:** If Fractional Remainder type is selected, this entry determines the number of bits in the fractional port output.

##### Radix2 Options

- **Radix2 throughput:** Determines the interval in clocks between new data being input (and output). Choices are 1, 2, 4, and 8.

##### High Radix Options

- **Detect divide by zero:** Determines if the core shall have a division-by-zero indication output port.



### AXI Interface

AXI behavior:

- **NonBlocking:** This
- **Blocking:** This

AXI implementation emphasis:

- ◆ **Resources:** *Automatic* (fully pipelined) or *Manual* (determined by following field).
- ◆ **Performance:** This

### Latency Options

- ◆ **Latency configuration:** *Automatic* (fully pipelined) or *Manual* (determined by following field).
- ◆ **Latency:** This field determines the exact latency from input to output in terms of clock enabled clock cycles.

## Optional Ports tab

Parameters specific to the Optional Ports tab are:

### Optional Ports

#### Divided Channel Ports

- ◆ **Has TUSEER:** Adds a tuser input port to the dividend channel.
- ◆ **Has TLAST:** Adds a tlast output port to the dividend channel.

#### Divisor Channel Ports

- ◆ **Has TUSEER:** Adds a tuser input port to the divisor channel.
- ◆ **Has TLAST:** Adds a tlast output port to the divisor channel.

**ACLKEN:** Specifies that the block has a clock enable port (the equivalent of selecting the Has ACLKEN option in the CORE Generator GUI).

**ARESETn:** Specifies that the block has a reset port. Active low synchronous clear. A minimum ARESETn pulse of two cycles is required.

**m\_axis\_dout\_tready:** Specifies that the block has a dout\_tready output port.

**Input TLAST combination for output:** Determines the behavior of the dout\_tlast output port.

- ◆ **Null:** Output is null.
- ◆ **Pass\_Dividend\_TLAST:** Pass the value of the dividend\_tlast input port to the dout\_tlast output port.
- ◆ **Pass\_Divisor\_TLAST:** Pass the value of the divisor\_tlast input port to the dout\_tlast output port.
- ◆ **OR\_all\_TLASTS:** Pass the logical OR of all the present TLAST input ports.
- ◆ **AND\_all\_TLASTS:** Pass the logical AND of all the present TLAST input ports.

Other parameters used by this block are explained in the topic

[Common Options in Block Parameter Dialog Boxes.](#)

## LogiCORE™ Documentation

[LogiCORE IP Divider Generator 4.0](#)

## Device Support

Virtex-7, Kintex-7, Artix-7, Zynq-7000, Virtex-6, Spartan-6

## Down Sample

This block is listed in the following Xilinx Blockset libraries: *Basic Elements and Index*.

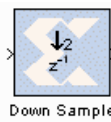

The Xilinx Down Sample block reduces the sample rate at the point where the block is placed in your design.

The input signal is sampled at even intervals, at either the beginning (first value) or end (last value) of a frame. The sampled value is presented on the output port and held until the next sample is taken.

A Down Sample frame consists of  $1/l$  input samples, where  $l$  is sampling rate. An example frame for a Down Sample block configured with a sampling rate of 4 is shown below.

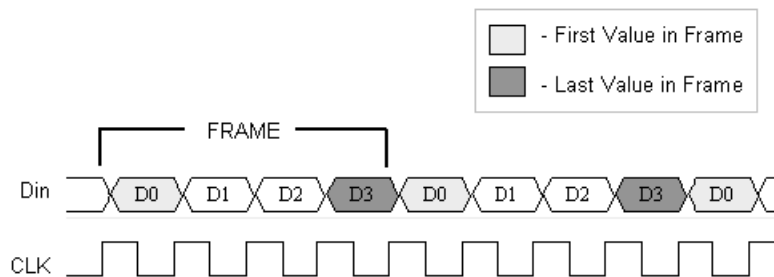

The Down Sample block is realized in hardware using one of three possible implementations that vary in terms of implementation efficiency. The block receives two clock enable signals in hardware, `Src_CE` and `Dest_CE`. `Src_CE` is the faster clock enable signal and corresponds to the input data stream rate. `Dest_CE` is the slower clock enable, corresponding to the output stream rate, for example, down sampled data. These enable signals control the register sampling in hardware.

### Zero Latency Down Sample

The zero latency Down Sample block must be configured to sample the first value of the frame. The first sample in the input frame passes through the mux to the output port. A register samples this value during the first sample duration and the mux switches to the register output at the start of the second sample of the frame. The result is that the first sample in a frame is present on the output port for the entire frame duration. This is the least efficient hardware implementation as the mux introduces a combinational path from `Din` to `Dout`. A single bit register adjusts the timing of the destination clock enable, so that it is asserted at the start of the sample period, instead of the end. The hardware implementation is shown below:

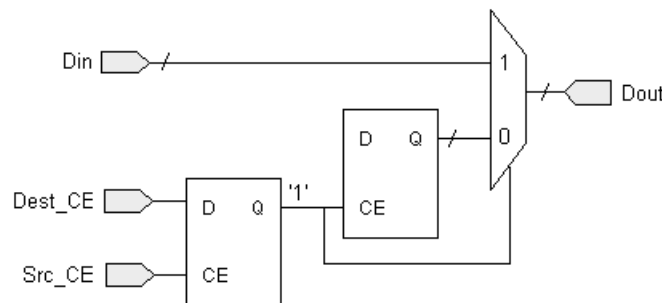

## Down Sample with Latency

If the Down Sample block is configured with latency greater than zero, a more efficient implementation is used. One of two implementations is selected depending on whether the Down Sample block is set to sample the first or last value in a frame.

### Sample First Value in Frame

In this case, two registers are required to correctly sample the input stream. The first register is enabled by the adjusted clock enable signal so that it samples the input at the start of the input frame. The second register samples the contents of the first register at the end of the sample period to ensure output data is aligned correctly.

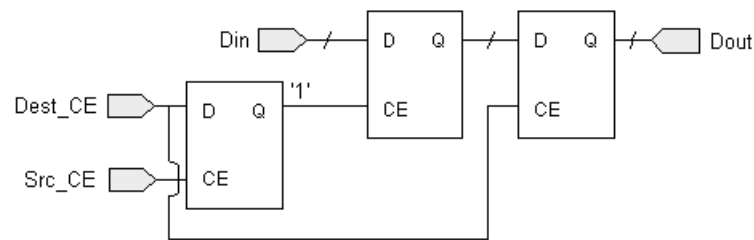

### Sample Last Value in Frame

The most efficient implementation is used when the Down Sample block is configured to sample the last value of the frame. In this case, a register samples the data input data at the end of the frame. The sampled value is presented for the duration of the next frame.

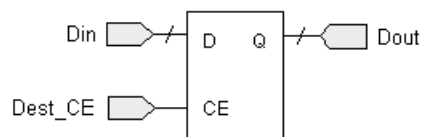

## Block Parameters

The block parameters dialog box can be invoked by double-clicking the icon in your Simulink model.

### Basic tab

Parameters specific to the Basic tab are:

- **Sampling Rate (number of input samples per output sample):** must be an integer greater or equal to 2. This is the ratio of the output sample period to the input, and is essentially a sample rate divider. For example, a ratio of 2 indicates a 2:1 division of the input sample rate. If a non-integer ratio is desired, the Up Sample block can be used in combination with the Down Sample block.
- **Sample:** The Down Sample block can sample either the first or last value of a frame. This parameter will determine which of these two values is sampled.

Other parameters used by this block are explained in the topic [Common Options in Block Parameter Dialog Boxes](#).

## Xilinx LogiCORE

The Down Sample block does not use a Xilinx LogiCORE™.

## DSP48

This block is listed in the following Xilinx Blockset libraries: *Index, DSP*.

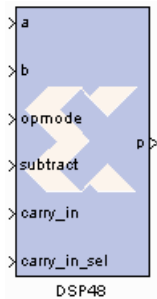

The Xilinx DSP48 block is an efficient building block for DSP applications that use Xilinx Virtex®-4 devices. The DSP48 combines an 18-bit by 18-bit signed multiplier with a 48-bit adder and programmable mux to select the adder's input.

Operations can be selected dynamically. Optional input and multiplier pipeline registers can be selected as well as registers for the subtract, carryin and opmode ports. The DSP48 block can also target devices that do not contain the DSP48 hardware primitive if the Use synthesizable model option is selected.

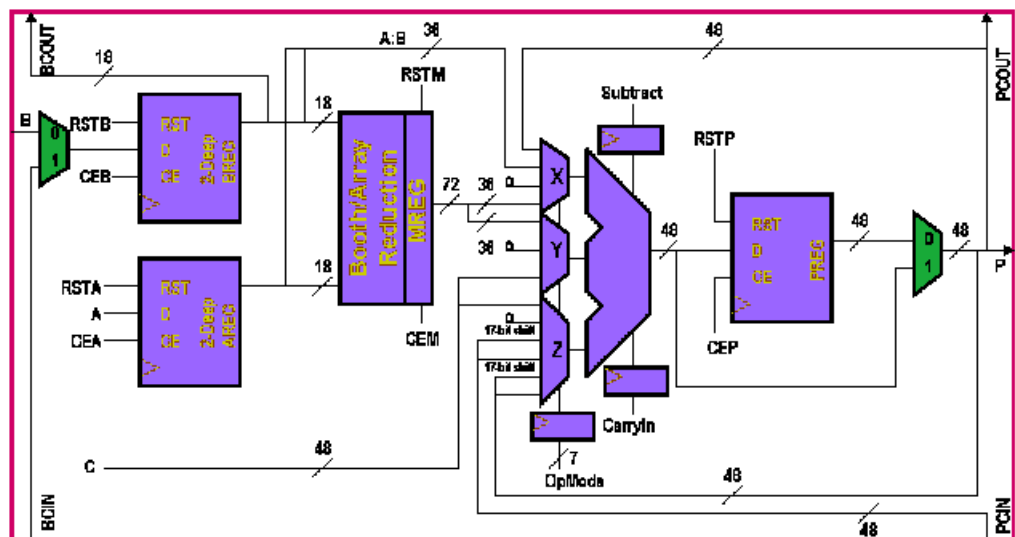

### Block Parameters

The block parameters dialog box can be invoked by double-clicking the icon in your Simulink model.

#### Basic tab

Parameters specific to the Basic tab are as follows:

- **B or BCIN input:** specifies if the B input should be taken directly from the b port or from the cascaded bcin port. The bcin port can only be connected to another DSP48 block.
- **Consolidate control port:** when selected, combines the opmode, subtract, carry\_in and carry\_in\_sel ports into one 11-bit port. Bits 0 to 6 are the opmode, bit 7 is the subtract port, bit 8 is the carry\_in port, and bits 9 and 10 are the carry\_in\_sel port. This option should be used when a constant block is used to generate a DSP48 instruction.
- **Provide C port:** when selected, the c port is made available. Otherwise, the c port is tied to '0'.
- **Provide PCIN port:** when selected, the pcin port is exposed. The pcin port must be connected to the pcout port of another DSP48 block.
- **Provide PCOUT port:** when selected, the pcout output port is made available. The pcout port must be connected to the pcin port of another DSP48 block.

- **Provide BCOUT port:** when selected, the `bcout` output port is made available. The `bcout` port must be connected to the `bcin` port of another DSP48 block.
- **Provide global reset port:** when selected, the port `rst` is made available. This port is connected to all available reset ports based on the pipeline selections.
- **Provide global enable port:** when selected, the optional `en` port is made available. This port is connected to all available enable ports based on the pipeline selections.

## Pipelining

Parameters specific to the Pipelining tab are as follows:

- **Length of A pipeline:** specifies the length of the pipeline on input register A. A pipeline of length 0 removes the register on the input.
- **Length of B/BCIN pipeline:** specifies the length of the pipeline for the `b` input whether it is read from `b` or `bcin`.
- **Pipeline C:** indicates whether the input from the `c` port should be registered.
- **Pipeline P:** indicates whether the outputs `p` and `pcout` should be registered.
- **Pipeline multiplier:** indicates whether the internal multiplier should register its output.
- **Pipeline opmode:** indicates whether the `opmode` port should be registered.
- **Pipeline subtract:** indicates whether the subtract port should be registered.
- **Pipeline carry in:** indicates whether the `carry_in` port should be registered.
- **Pipeline carry in sel:** indicates whether the `carry_in_sel` port should be registered.

## Ports tab

Parameters specific to the Ports tab are as follows:

- **Reset port for A:** when selected, a port `rst_a` is made available. This resets the pipeline register for port `a` when set to '1'.
- **Reset port for B:** when selected, a port `rst_b` is made available. This resets the pipeline register for port `b` when set to '1'.
- **Reset port for C:** when selected, a port `rst_c` is made available. This resets the pipeline register for port `c` when set to '1'.
- **Reset port for multiplier:** when selected, a port `rst_m` is made available. This resets the pipeline register for the internal multiplier when set to '1'.
- **Reset port for P:** when selected, a port `rst_p` is made available. This resets the output register when set to '1'.
- **Reset port for carry in:** when selected, a port `rst_carryin` is made available. This resets the pipeline register for carry in when set to '1'.
- **Reset port for controls (opmode, subtract, carry\_in, carry\_in\_sel):** when selected, a port `rst_ctrl` is made available. This resets the pipeline register for the subtract register (if available), `opmode` register (if available) and `carry_in_sel` register (if available) when set to '1'.
- **Enable port for A:** when selected, an enable port `ce_a` for the port A pipeline register is made available.
- **Enable port for B:** when selected, an enable port `ce_b` for the port B pipeline register is made available.
- **Enable port for C:** when selected, an enable port `ce_c` for the port C register is made available.

- **Enable port for multiplier:** when selected, an enable port `ce_m` for the multiplier register is made available.
- **Enable port for P:** when selected, an enable port `ce_p` for the port P output register is made available.
- **Enable port for carry in:** when selected, an enable port `ce_carry_in` for the carry in register is made available.
- **Enable port for controls (opmode, subtract, carry\_in, carry\_in\_sel):** when selected, the enable ports `ce_ctrl` and `ce_cinsub` are made available. The port `ce_ctrl` controls the opmode and carry in select registers while `ce_cinsub` controls the subtract register.

### Implementation tab

- **Use synthesizable model:** when selected, the DSP48 is implemented from an RTL description which might not map directly to the DSP48 hardware. This is useful if a design using the DSP48 block is targeted at device families that do not contain DSP48 hardware primitives.
- **Use adder only:** when selected, the block is optimized in hardware for maximum performance without using the multiplier. If an instruction using the multiplier is encountered in simulation, an error is reported.

Other parameters used by this block are explained in the topic [Common Options in Block Parameter Dialog Boxes](#).

### See Also

The following topics give valuable insight into using and understanding the DSP48 block:

[DSP48 Macro](#)

[Generating Multiple Cycle-True Islands for Distinct Clocks](#)

[Xilinx XtremeDSP™](#)



## DSP48 Macro

This block is listed in the following Xilinx Blockset libraries: *Index, DSP*.



The System Generator DSP48 Macro block provides a device independent abstraction of the blocks DSP48, DSP48A, and DSP48E. Using this block instead of using a technology-specific DSP slice helps make the design more portable between Xilinx technologies.

Depending on the target technology specified at compile time, the block wraps one DSP48/DSP48E/DSP48A block along with reinterpret and convert blocks for data type alignment, multiplexers to handle multiple opmodes and inputs, and registers.

**Note:** In the remainder of the text on this block, DSP/DSP48A/DSP48E are collectively referred to as XtremeDSP slice.

### Block Interface

The DSP48 Macro block has a variable number of inputs and outputs determined from user-specified parameter values. The input data ports are determined by the opmodes entered in the Instructions field of the DSP48 Macro. Input port Sel appears if more than one opmode is specified in the Instructions field. The Instructions field is discussed in greater detail in the topic on Entering Opmodes in the DSP48 Macro block.

Port P, an output data port, is the only port appearing in all configurations of the DSP48 Macro. Output ports PCOUT, BCOUT, ACOUT, CARRYOUT, and CARRYCASCOUT appear depending on the user-selections.

### Block Parameters

The block parameters dialog box can be invoked by double-clicking the icon in your Simulink model.

#### Basic tab

Parameters specific to the Basic tab are:

- **Inputs to Port A:** This field specifies symbolic port identifiers or operands appearing in the Instructions field as connected to port A or port A:B on the XtremeDSP slice.
- **Inputs to port B:** This field specifies symbolic port identifiers or operands appearing in the Instructions field as connected to port B.
- **Inputs to port C:** This field specifies symbolic port identifiers or operands appearing in the Instructions field as connected to port C.
- **Instructions:** This field specifies instructions for the Macro. Refer to the topic on [Entering Opmodes in the DSP48 Macro Block](#).

#### Pipelining tab

- **Pipeline Options:** This field specifies the pipelining options on the XtremeDSP slice and latency on the data presented to each port of the XtremeDSP slice. Available options include 'External Registers', 'No External Registers' and 'Custom'. When 'External Registers' is selected multiplexer outputs (underneath DSP48 Macro) are registered (this allows high speed operation). If the DSP48 Macro configures the XtremeDSP slice as an adder only (inferred from the operations entered in the instructions field), then the latency is 3 else the latency is 4.

When 'No External Registers' is selected, multiplexer outputs are not registered and the latency of the DSP48 Macro becomes two. When 'Custom' is selected all register instances inside and outside of the XtremeDSP slice are inferred from the Custom Pipeline Options. If the Instructions require the use of the XtremeDSP slice as adder and multiplier then it must be configured to use Custom Pipeline Option.

- **Custom Pipeline Options:** This group of controls is active only when Pipeline Options is set to Custom. Provides individual control for instancing the XtremeDSP slice and multiplexer registers.
- **Custom Pipeline Options([A,B,C,P,Ctrl,M,MuxA,MuxB,MuxC,MuxCtrl]):** This field enables you to specify Custom Pipeline Options as an array of integers.

## Ports tab

The Ports tab consists of controls to expose the BCOUT, ACOUT, CARRYOUT, CARRYCASCOUT, PCOUT and the various XtremeDSP slice Reset and Enable Ports.

## Implementation tab

- **Use DSP48:** This field tells System Generator to use the XtremeDSP slice on Virtex®-4, Virtex-5 or Spartan®-3A DSP, which ever is the target technology. If unchecked, a synthesizable model of the XtremeDSP slice is used that can be used in other devices.

## Entering Opcodes in the DSP48 Macro Block

The DSP48 is capable of performing different arithmetic operations on input data depending on the input to its opcode port; this capability enables the DSP48 to operate like a dynamic operator unit. The DSP48 Macro simplifies using the DSP48 as a dynamic operator unit. It orders multiple operands and opcodes with multiplexers and appropriately aligns signals on the data ports. The ordering of operands and opcode execution is determined by the order of opcodes entered in the Instructions field. The Instructions field must contain at least one opcode and a maximum of eight opcodes. This topic details all the issues involved with entering opcodes in the Instructions field of the DSP48 Macro.

## Opcode Format

A newline character is used to separate two different opcodes. Each opcode must strictly adhere to the rules listed below:

- Each opcode is an assignment to P and must begin with 'P='
- The expression following the assignment operator('=') must be entirely made up of +/-/\* operators and symbolic port identifiers (see Operand Format) for operands.
- Only opcodes that can be implemented on the DSP48 are legal. A list of opcodes supported on the DSP48 Macro is provided in Table 2.

Consider the simple model shown below. The DSP48 Macro has three inputs defined as Xo, Yo, and Zo. Because more than one Instruction opcode is specified in block dialog box, the Sel input port is automatically added:

### Implementing a Complex Multiplier using the DSP48 Macro block

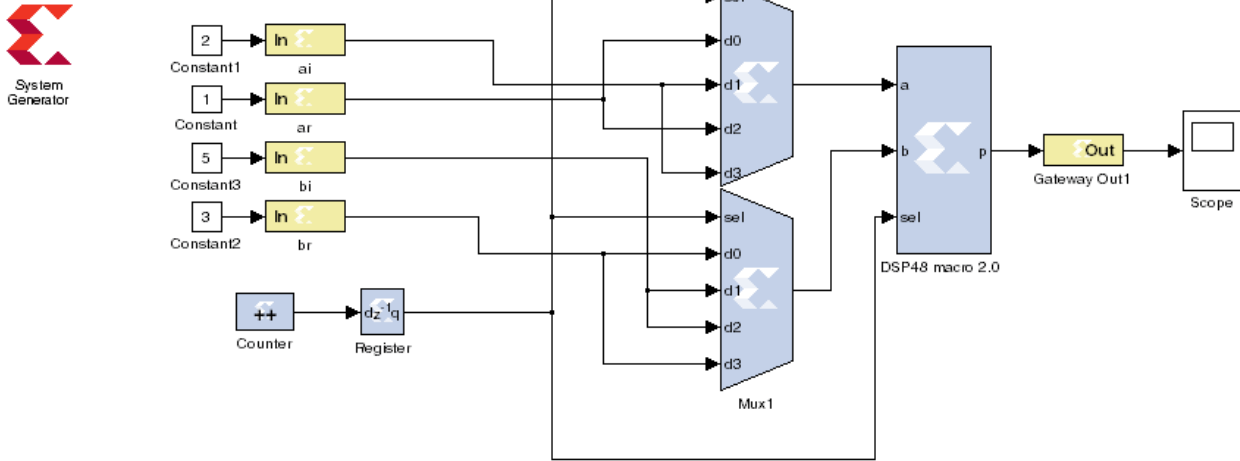

The figure below shows the DSP48 Macro dialog box for the above diagram. Three legal opcodes are entered in the Instructions field.

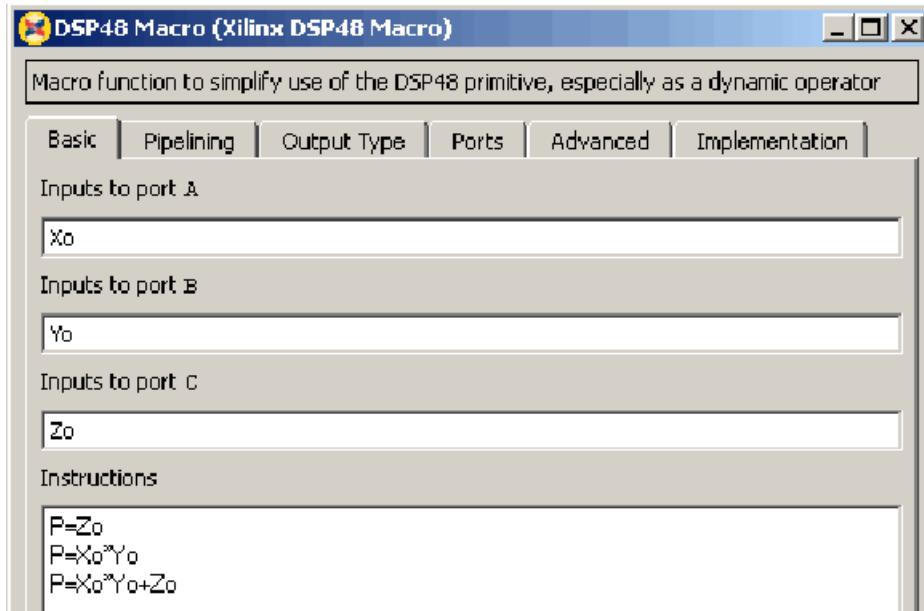

When 0 is specified on the Sel input, the first instruction opcode is implemented. The value on Zo is feed directly to output P. In this example, 5 will appear at the output.

When 1 is specified on Sel, the second Instruction opcode ( $Xo*Yo$ ) is implemented. In this case, the number 12 will appear at the output.

When 2 is specified on Sel, the third instruction ( $Xo*Yo+Zo$ ) is implemented and the ouput in this case goes to the number 17.

When this design is compiled, if the target technology is Virtex®-4, then a DSP48 slice is netlisted. If Virtex-5 is specified, then a DSP48E slice is netlisted, and if the Spartan®-3A DSP technology is specified, then a DSP48A slice is used in the implementation.

## Operand Format

Each operand (symbolic port identifier) used in an opcode must follow the rules listed below:

- Each symbolic port identifier must begin with an alphabet[a-z,A-Z] and can be followed by any number of alphanumeric characters or underscore('\_').
- The symbolic port identifiers must not match any of the reserved port identifiers listed in Table 1 irrespective of case
- Each of the symbolic port identifiers must be listed once and only once in the Inputs to Port A, Port B, or Port C fields. Multiple symbolic port identifiers in the same list must be separated using a space or ','.

In the figure above, Xo, Yo, and Zo are the symbolic port identifiers. Examples of legal symbolic port identifiers/operands are a1, signal\_1, delayed\_signal etc. Examples of illegal symbolic port identifiers include Cin, \_port1, delay\$, 12signal etc.

## Reserved Port Identifiers.

Reserved Port Identifier	Port Type	Memory Type
PCIN	Input. Connected to port PCIN on the DSP48	This port appears depending on the opcode used. Refer to Table 2, Opcodes 0x10-0x1f use the PCIN Inport. The PCIN port must be connected to the PCOUT port of another DSP48 block/DSP48 Macro block.
BCIN	Input. Connected to port BCIN on the DSP48	This port appears if in any of the opcodes listed in Table 2, B(not A:B) is replaced with BCIN. Must be connected to the BCOUT port of another DSP48 block/DSP48 Macro block.
PCIN>>17	Input. Connected to port PCIN on the DSP48	Refer to Table 2. Opcodes 0x50-0x5f use this port identifier. PCIN, is right shifted by 17 and input to the DSP48 adder through DSP48's z multiplexer.
CIN	Input. Connected to port carry_in on the DSP48	This port appears if the opcode contains Cin. Refer to Table 2. Optional on all opcodes except 0x00.
PCOUT	Output. Connected to port PCOUT on the DSP48	This port appears if <b>PCOUT</b> on the Ports tab is selected.

Reserved Port Identifier	Port Type	Memory Type
ACOUT	Output. Connected to port ACOUT on the DSP48	This port appears if <b>ACOUT</b> on the Ports tab is selected.
BCOUT	Output. Connected to port BCOUT on the DSP48	This port appears if <b>BCOUT</b> on the Ports tab is selected.
rst_all	Input. Connected to rst on the DSP48 as well as all registers' reset	This port appears if <b>Global Reset</b> on the Ports tab is selected.
ce_all	Input. Connected to en on the DSP48 as well as all registers' enable	This port appears if 'Global Enable' on the ports tab is selected.
Sel	Input	Appears only when more than one opmode instruction is specified in the Instructions field. Used to select an opmode from the list of opmodes in the Instructions field.
P	Output	Always present.
P>>17	-	Refer to Table 2. Opmodes 0x60-0x6f. P, right shifted by 17 is input to the DSP48 adder through the DSP48's z multiplexer.

### Opmode Selection

As stated previously, if more than one opmode is specified in the Instructions field, opmode selection must be provided by the block. This is achieved through the use of the 'Sel' port that appears when there is more than one opmode in the Instructions field. The 'Sel' port is connected to multiplexers instanced underneath the mask; any signal connected to the Sel port must be of the appropriate data type. The value of the Sel signal for each opmode listed in the Instructions field corresponds to the position of the opmode. The first position is position 0, then second position is 1, and so on.

### Using Reserved Identifiers

There are two categories of reserved identifiers. Reserved identifiers that manifest as ports on the DSP48 Macro block and reserved identifiers that do not. Descriptions and usage of each of the reserved word identifiers is listed in the Table above. An example of using PCIN and BCIN reserved

words is depicted in the following figure. The Instructions are:  $P=PCIN + A*BCIN$

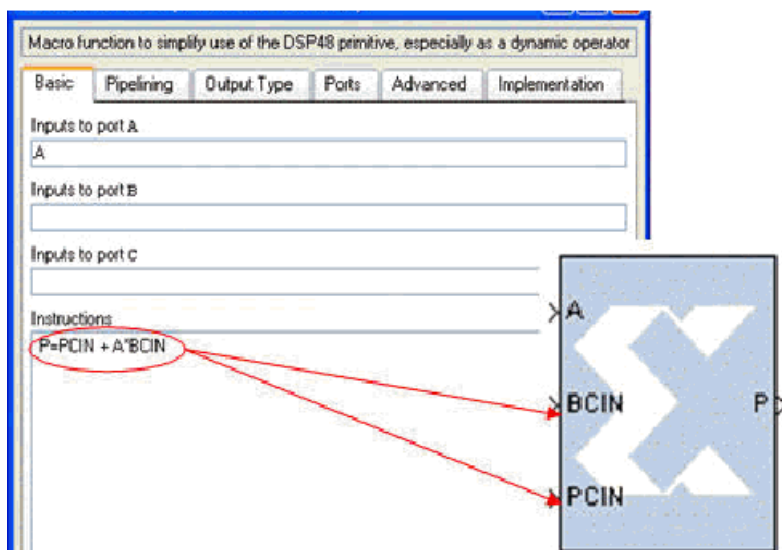

## Mode Selection

The DSP48 Macro can be operated in two modes: Adder Mode and Multiplier Mode. Mode selection depends on the DSP48 Macro opmodes used; the opmodes supported by each of the modes is listed in Table 2. When A and B ports are routed as inputs to the DSP48's adder, they are concatenated as one signed 36-bit input (refer to the DSP48 documentation). The DSP48's multiplier interprets the ports as two disjoint signed 2's complement 18-bit inputs.

## DSP48 Opmodes

In the following table, Cin is optional in all the Opmodes. A:B refers to all the symbolic port identifiers in 'Inputs to Port A' field of DSP48 Macro block mask supplying inputs to the Adder of DSP48 block. Symbols A, B, and C refer to symbolic identifiers in Inputs to Port A, Port B and Port C fields respectively. All other symbols are reserved (refer to Reserved Port Identifier table above for more details).

DSP48 Macro Pseudo Opmode	DSP48 Macro Mode	Supported for DSP48	Supported for DSP48E	Supported for DSP48A
P=Cin P=+Cin P=-Cin	----	Yes	Yes	Yes
P=P+Cin P=-P-Cin	----	Yes	Yes	Yes
P = A:B + Cin	Adder	Yes	Yes	Yes
P = A*B + Cin P = -A*B - Cin	Multiplier	Yes	Yes	Yes
P=C+Cin P=-C-Cin	----	Yes	Yes	Yes

DSP48 Macro Pseudo Opmode	DSP48 Macro Mode	Supported for DSP48	Supported for DSP48E	Supported for DSP48A
P=+C+P+Cin P=-C-P-Cin	----	Yes	Yes	Yes
P=A:B + C + Cin P = -A:B -C-Cin	Adder	Yes	Yes	Yes
P = PCIN + Cin P = PCIN -Cin	----	Yes	Yes	Yes(A:B + C + Cin only)
P=PCIN+P+Cin P=PCIN-P-Cin	----	Yes	Yes	Yes
P=PCIN+A:B+Cin P=PCIN-A:B-Cin	Adder	Yes	Yes	Yes
P=PCIN+A*B+Cin P=PCIN-A*B-Cin	Multiplier	Yes	Yes	Yes
P=PCIN+C +Cin P=PCIN-C -Cin	----	Yes	Yes	No
P=PCIN+C+P+Cin P=PCIN-P-C-Cin	----	Yes	Yes	No
P=PCIN+A:B+C+Cin P=PCIN-A:B-C-Cin	Adder	Yes	Yes	No
P=P-Cin	----	Yes	Yes	Yes
P=P+P+Cin P=P-P-Cin	----	Yes	Yes	Yes
P=P-A:B-Cin P=P+A:B+Cin	Adder	Yes	Yes	Yes
P=P+A*B+Cin	Multiplier	Yes	Yes	Yes
P=P+C+Cin P=P-C-Cin	----	Yes	Yes	No
P=P+C+P+Cin P=P-C-P-Cin	----	Yes	Yes	No
P=P+C+P+Cin P=P-C-P-Cin	Adder	Yes	Yes	No
P=C-Cin	----	Yes	Yes	Yes
P=C-P-Cin	----	Yes	Yes	Yes
P=C-A:B-Cin	Adder	Yes	Yes	Yes
P=C-A*B-Cin	Multiplier	Yes	Yes	Yes
P=C+C+Cin P=C-C-Cin	----	Yes	Yes	No

DSP48 Macro Pseudo Opmode	DSP48 Macro Mode	Supported for DSP48	Supported for DSP48E	Supported for DSP48A
P=C+C+P+Cin P=C-C-P-Cin	----	Yes	Yes	No
P=PCIN>>17+Cin , P=PCIN>>17Cin	----	Yes	Yes	No
P=PCIN>>17+P+Cin P=PCIN>>17-P-Cin	----	Yes	Yes	No
P=PCIN>>17+A:B+Cin P=PCIN>>17-A:B-Cin	Adder	Yes	Yes	No
P=PCIN>>17+A*B+Cin P=PCIN>>17-A*B-Cin	Multiplier	Yes	Yes	No
P=PCIN>>17+C+Cin P=PCIN>>17-C-Cin	----	Yes	Yes	No
P=PCIN>>17+P+C+Cin P=PCIN>>17-P-C-Cin	----	Yes	Yes	No
P=PCIN>>17+C+A:B+Cin P=PCIN>>17-C-A:B-Cin	Adder	Yes	Yes	No
P=P>>17+Cin P=P>>17-Cin	----	Yes	Yes	No
P=P>>17+P+Cin P=P>>17-P-Cin	----	Yes	Yes	No
P=P>>17+A:B+Cin P=P>>17-A:B-Cin	Adder	Yes	Yes	No
P=P>>17+A*B+Cin P=P>>17-A*B-Cin	Multiplier	Yes	Yes	No
P=P>>17+C+Cin P=P>>17-C-Cin	----	Yes	Yes	No
P=P>>17+P+C+Cin P=P>>17-P-C-Cin	----	Yes	Yes	No
P=P>>17+C+A:B +Cin P=P>>17-C-A:B-Cin	Adder	Yes	Yes	No

## Entering Pipeline Options and Editing Custom Pipeline Options

Since the data paths for the A, B and C ports are different and can have a different number of registers, time-alignment issues arise. Control signals also suffer from the same issue. This makes the pipeline model extremely important. There are three pipeline options available in the DSP48 Macro block mask. These include 'External Registers', 'No External Registers' and 'Custom'.



## External Registers

This option aligns all the control and data signals by also using additional registers external to the DSP48 block. These external registers are required to register the output of the multiplexers to ensure high-speed operation. If all the opmodes entered into the DSP48 Macro instructions field are such that, they require the use of multiplier, then the latency on the DSP48 Macro is 4. If none of the instructions on the DSP48 Macro require the use of the multiplier, the latency on the DSP48 Macro is 3.

## No External Registers

This option aligns all the control and data signals without using registers external to the DSP48 block. The MREG is not selected in this mode. The latency of the DSP48 Macro is 2.

## Custom

This option gives you control over instantiating each register of the DSP48 Macro block. When this option is selected the 'Custom Pipeline Options' group of controls becomes active and each of the individual registers can be selected. When the DSP48 Macro contains instructions that require using the multiplier in the DSP48 and the Adder with A:B as one of the inputs, Custom pipeline is the only legal option.

## DSP48 Macro Limitations

Though the DSP48 Macro eases the use of the DSP 48 block it is not without limitations:

- It does not support the DSP48's rounding features
- It supports carry-in only from fabric
- It does not support all input data types. Input data types that exceed the data type restrictions of a single DSP48 are not supported currently. For example if, after alignment of inputs, the input to Port A of DSP48 exceeds 18bits then it will result in an error

## See Also

The following topics give valuable insight into using and understanding the DSP48 block:

[DSP48 block](#)

[Generating Multiple Cycle-True Islands for Distinct Clocks](#)

[Xilinx XtremeDSP™](#)

## DSP48 macro 2.0

This block is listed in the following Xilinx Blockset libraries: *Index, DSP*.

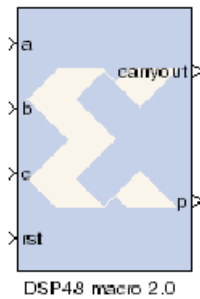

The System Generator DSP48 macro 2.0 block provides a device independent abstraction of the blocks DSP48, DSP48A, and DSP48E. Using this block instead of using a technology-specific DSP slice helps makes the design more portable between Xilinx technologies.

The DSP48 Macro provides a simplified interface to the XtremeDSP slice by the abstraction of all opmode, subtract, alumode and inmode controls to a single SEL port. Further, all CE and RST controls are grouped to a single CE and SCLR port respectively. This abstraction enhances portability of HDL between device families.

You can specify 1 to 64 instructions which are translated into the various control signals for the XtremeDSP slice of the target device. The instructions are stored in a ROM from which the appropriate instruction is selected using the SEL port.

### Block Parameters

#### Instructions tab

The Instruction tab is used to define the operations that the LogiCORE is to implement. Each instruction can be entered on a new line, or in a comma delimited list, and are enumerated from the top down. You can specify a maximum of 64 instructions.

Refer to the topic Instructions Page (page 3) of the of the document [LogiCORE IP DSP48 Macro 2.0](#) for details on all the parameters for this LogicCore IP..

#### Pipeline Options tab

The Pipeline Options tab is used to define the pipeline depth of the various input paths.

##### Pipeline Options

Specifies the pipeline method to be used; **Automatic**, **By Tier** and **Expert**.

##### Custom Pipeline options

Used to specify the pipeline depth of the various input paths.

##### Tier 1 to 6

When **By Tier** is selected for Pipeline Options these parameters are used to enable/disable the registers across all the input paths for a given pipeline stage. The following restrictions are enforced:

- ◆ When P has been specified in an expression tier 6 will forced as asynchronous feedback is not supported.
- ◆ On Spartan-3ADSP/6 tier 3 is forced when tier 5 and the pre-adder has been specified. The registering of the pre-adder control signals cannot be separated from the second stage adder control signals.

### Individual registers

When you select **Expert** for the Pipeline Options, these parameters are used to enable/disable individual register stages. The following restrictions are enforced.

- ◆ The P register is forced when P is specified in an expression. Asynchronous feedback is not supported.
- ◆ On Spartan-3ADSP/6 pipeline stage 5 CARRYIN register is tied to the stage 5 SEL register. The Stage 3 SEL register is forced when the stage 5 SEL register and the pre-adder are specified.
- ◆ On Virtex-4 pipeline stage 5 CARRYIN register is forced when a rounding function on any multiplier input is specified.

Refer to the topic Detailed Pipe Implementation (page 9) of the document [LogiCORE IP DSP48 Macro 2.0](#) for details on all the parameters for this LogicCore IP.

### Implementation tab

The Implementation tab is used to define implementation options.

#### Output Port Properties

- **Precision:** Specifies the precision of the P output port.
  - ◆ **Full:** The bit width of the output port P is set to the full XtremeDSP Slide width of 48 bits.
  - ◆ **User\_Defined:** The output width of P can be set to any value up to 48 bits. When set to less than 48 bits, the output is truncated (LSBs removed).
- **Width:** Specifies the User Defined output width of the P output port
- **Binary Point:** Specifies the placement of the binary point of the P output port

#### Special ports

- **Use ACOUT:** Use the optional cascade A output port.
- **Use BCOUT:** Use the optional cascade B output port.
- **Use CARRYCASCOUT:** Use the optional cascade carryout output port.
- **Use PCOUT:** Use the optional cascade P output port.

#### Control ports

Refer to the topic Implementation Page (page 4) of the document [LogiCORE IP DSP48 Macro 2.0](#) for details on all the parameters for this LogicCore IP.

### Migrating a DSP48 Macro Block Design to DSP48 Macro 2.0

In Release 11.4, Xilinx introduced version 2.0 of the DSP Macro block. The following text describes how to migrate an existing DSP Macro block design to DSP Macro 2.0.

One fundamental difference of the new DSP48 Macro 2.0 block compared to the previous version is that internal input multiplexer circuits are removed from the core in order to streamline and minimize the size of logic for this IP. This has some implications when migrating from an existing design with DSP48 Macro to the new DSP48 Macro 2.0. You can no longer specify multiple input operands (for example, A1, A2, B1, B2, etc...). Because of this, you must add a simple MUX circuit when designing with the new DSP48 Macro 2.0 if there is more than one unique input operand as shown in the following example.

## DSP48 Macro-Based Signed 35x35 Multiplier

The following DSP48 Macro consists of multiple 18-bit input operands such as alo, ahi for input to port A and blo, bhi for input to port B. The input operands and Opcode instructions are specified as shown below. Notice that the multiple input operands are handled internally by the DSP48 Macro block.

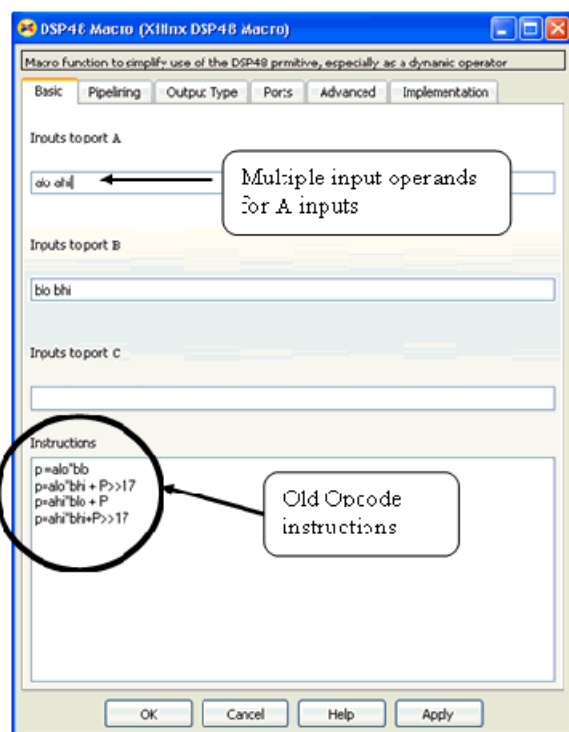
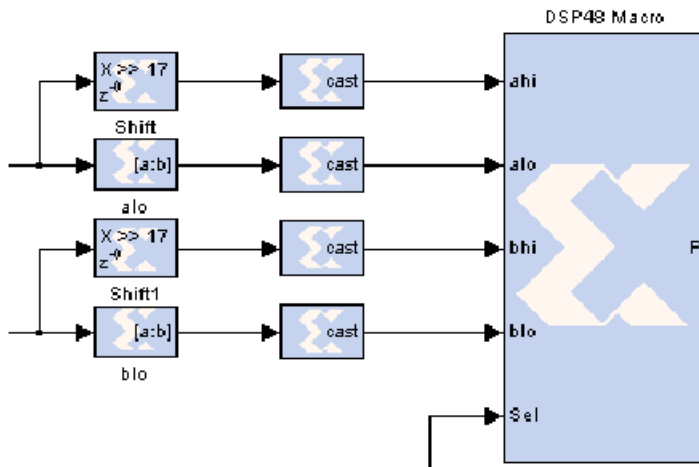

## DSP48 Macro 2.0-Based Signed 35x35 Multiplier

The same model shown above can be migrated to the new DSP48 Macro 2.0 block. The following simple steps and design guidelines are required when updating the design.

1. Make sure that input and output pipeline register selections between the old and the new block are the same. You can do this by examining and comparing the Pipeline Options settings.
2. If there is more than one unique input operand required, you must provide MUX circuits as shown in the figure below.
3. Ensure that the new design provides the same functionality correctness and quality of results compared to the old version. This can be accomplished by performing a quick Simulink simulation and implementing the design.
4. When configuring and specifying a pre-adder mode using the DSP48 Macro 2.0 block in System Generator, certain design parameters such as data width input operands are device dependent. Refer to the document [LogiCORE IP DSP48 Macro 2.0](#) for details on all the parameters for this LogicCore IP.

4 inputs and 2 outputs MUX circuit can be decoded as the following:

sel	A inputs	B inputs	Opcode
0	alo	blo	A*B
1	alo	bhi	A*B+P>>17
2	ahi	blo	A*B+P
3	ahi	bhi	A*B+P>>17

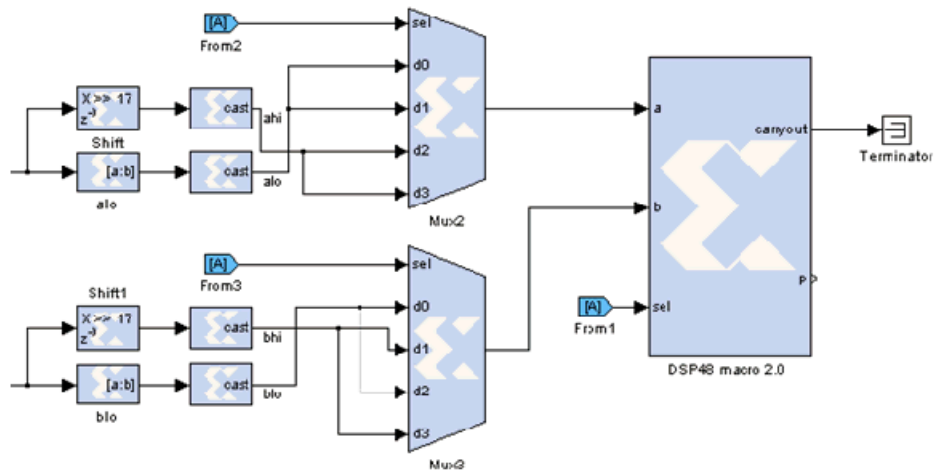

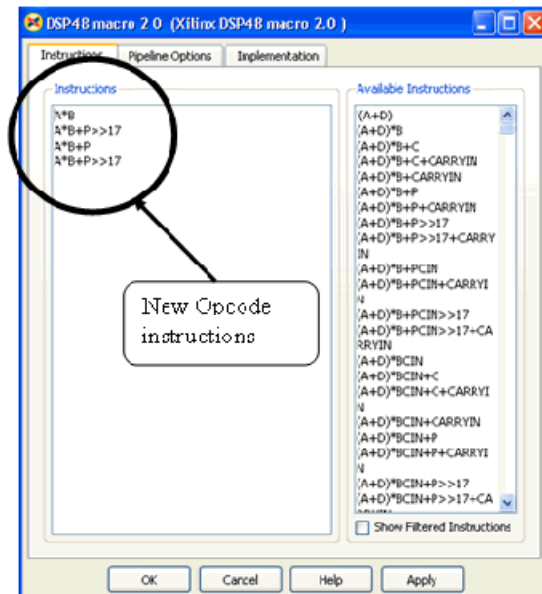

You can find the above complete model at the following pathname:

<sysgen\_path>/examples/dsp48/mult35x35/dsp48macro\_mult35x35.mdl

## LogiCORE™ Documentation

[LogiCORE IP DSP48 Macro 2.0](#)

## Device Support

Virtex-7 and Kintex-7, Virtex-6, Virtex-5, Virtex-4,  
Spartan-6, Spartan-3/XA, Spartan-3E/XA, Spartan-3A/3AN/3ADSP/XA

## See Also

The following topics give valuable insight into using and understanding the DSP48 block:

[DSP48 block](#)

[Generating Multiple Cycle-True Islands for Distinct Clocks](#)

[Xilinx XtremeDSP™](#)

## DSP48 Macro 2.1

This block is listed in the following Xilinx Blockset libraries: *Index, DSP*.

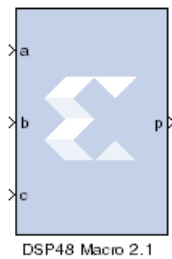

The System Generator DSP48 macro 2.1 block provides a device independent abstraction of the blocks DSP48, DSP48A, and DSP48E. Using this block instead of using a technology-specific DSP slice helps makes the design more portable between Xilinx technologies.

The DSP48 Macro provides a simplified interface to the XtremeDSP slice by the abstraction of all opmode, subtract, alumode and inmode controls to a single SEL port. Further, all CE and RST controls are grouped to a single CE and SCLR port respectively. This abstraction enhances portability of HDL between device families.

You can specify 1 to 64 instructions which are translated into the various control signals for the XtremeDSP slice of the target device. The instructions are stored in a ROM from which the appropriate instruction is selected using the SEL port.

### Block Parameters

#### Instructions tab

The Instruction tab is used to define the operations that the LogiCORE is to implement. Each instruction can be entered on a new line, or in a comma delimited list, and are enumerated from the top down. You can specify a maximum of 64 instructions.

Refer to the topic Instructions Page (page 3) of the document [LogiCORE IP DSP48 Macro 2.1](#) for details on all the parameters on this tab.

#### Pipeline Options tab

The Pipeline Options tab is used to define the pipeline depth of the various input paths.

##### Pipeline Options

Specifies the pipeline method to be used; **Automatic**, **By Tier** and **Expert**.

##### Custom Pipeline options

Used to specify the pipeline depth of the various input paths.

##### Tier 1 to 6

When **By Tier** is selected for Pipeline Options these parameters are used to enable/disable the registers across all the input paths for a given pipeline stage. The following restrictions are enforced:

- ◆ When P has been specified in an expression tier 6 will forced as asynchronous feedback is not supported.
- ◆ On Spartan-3ADSP/6 tier 3 is forced when tier 5 and the pre-adder has been specified. The registering of the pre-adder control signals cannot be separated from the second stage adder control signals.

### Individual registers

When you select **Expert** for the Pipeline Options, these parameters are used to enable/disable individual register stages. The following restrictions are enforced.

- ◆ The P register is forced when P is specified in an expression. Asynchronous feedback is not supported.
- ◆ On Spartan-3ADSP/6 pipeline stage 5 CARRYIN register is tied to the stage 5 SEL register. The Stage 3 SEL register is forced when the stage 5 SEL register and the pre-adder are specified.
- ◆ On Virtex-4 pipeline stage 5 CARRYIN register is forced when a rounding function on any multiplier input is specified.

Refer to the topic Detailed Pipe Implementaton (page 9) of the document [LogiCORE IP DSP48 Macro 2.1](#) for details on all the parameters on this tab.

### Implementation tab

The Implementation tab is used to define implementation options.

#### Output Port Properties

- **Precision:** Specifies the precision of the P output port.
  - ◆ **Full:** The bit width of the output port P is set to the full XtremeDSP Slide width of 48 bits.
  - ◆ **User\_Defined:** The output width of P can be set to any value up to 48 bits. When set to less than 48 bits, the output is truncated (LSBs removed).
- **Width:** Specifies the User Defined output width of the P output port
- **Binary Point:** Specifies the placement of the binary point of the P output port

#### Special ports

- **Use ACOUT:** Use the optional cascade A output port.
- **Use BCOUT:** Use the optional cascade B output port.
- **Use CARRYCASCOUT:** Use the optional cascade carryout output port.
- **Use PCOUT:** Use the optional cascade Poutput port.

#### Control ports

Refer to the topic Implementaton Page (page 4) of the document [LogiCORE IP DSP48 Macro 2.1](#) for details on all the parameters on this tab.

### Migrating a DSP48 Macro Block Design to DSP48 Macro 2.1

The following text describes how to migrate an existing DSP Macro block design to DSP Macro 2.1.

One fundamental difference of the new DSP48 Macro 2.1 block compared to the previous version is that internal input multiplexer circuits are removed from the core in order to streamline and minimize the size of logic for this IP. This has some implications when migrating from an existing design with DSP48 Macro to the new DSP48 Macro 2.1. You can no longer specify multiple input operands (for example, A1, A2, B1, B2, etc...). Because of this, you must add a simple MUX circuit when designing with the new DSP48 Macro 2.1 if there is more than one unique input operand as shown in the following example.

#### DSP48 Macro-Based Signed 35x35 Multiplier

The following DSP48 Macro consists of multiple 18-bit input operands such as alo, ahi for input to port A and blo, bhi for input to port B. The input operands and Opcode instructions are specified as



shown below. Notice that the multiple input operands are handled internally by the DSP48 Macro block.

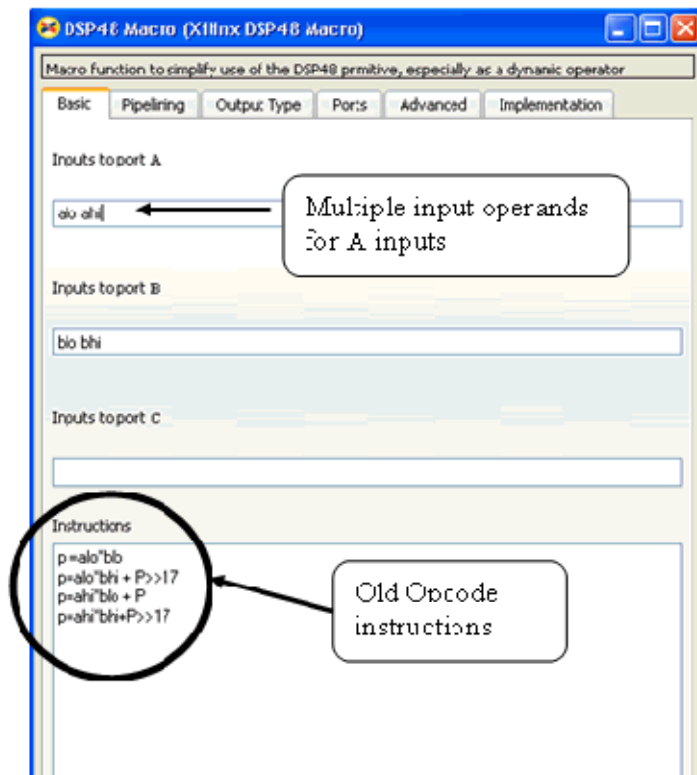
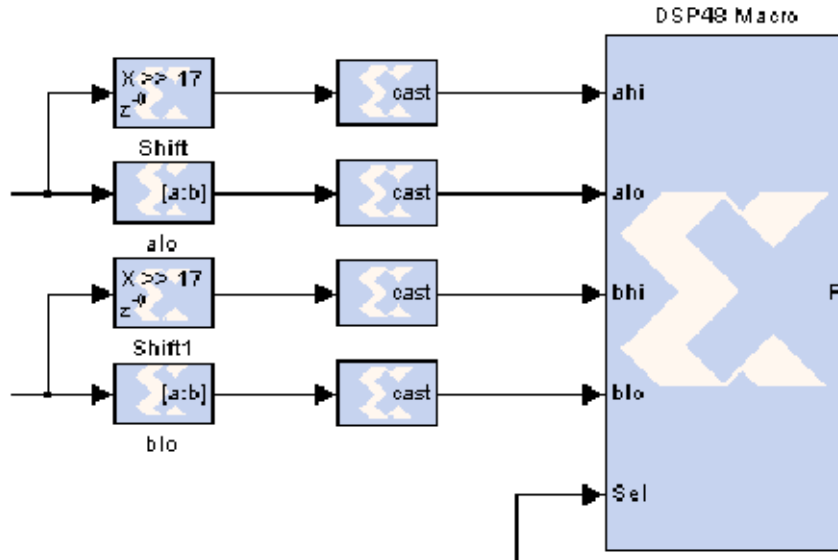

### DSP48 Macro 2.1-Based Signed 35x35 Multiplier

The same model shown above can be migrated to the new DSP48 Macro 2.1 block. The following simple steps and design guidelines are required when updating the design.

1. Make sure that input and output pipeline register selections between the old and the new block are the same. You can do this by examining and comparing the Pipeline Options settings.

2. If there is more than one unique input operand required, you must provide MUX circuits as shown in the figure below.
3. Ensure that the new design provides the same functionality correctness and quality of results compared to the old version. This can be accomplished by performing a quick Simulink simulation and implementing the design.
4. When configuring and specifying a pre-adder mode using the DSP48 Macro 2.1 block in System Generator, certain design parameters such as data width input operands are device dependent. Refer to the documenttttcu fffff for details on all the parameters of this LogicCore IP.  
4 inputs and 2 outputs MUX circuit can be decoded as the following:

sel	A inputs	B inputs	Opcode
0	alo	blo	A*B
1	alo	bhi	A*B+P>>17
2	ahi	blo	A*B+P
3	ahi	bhi	A*B+P>>17

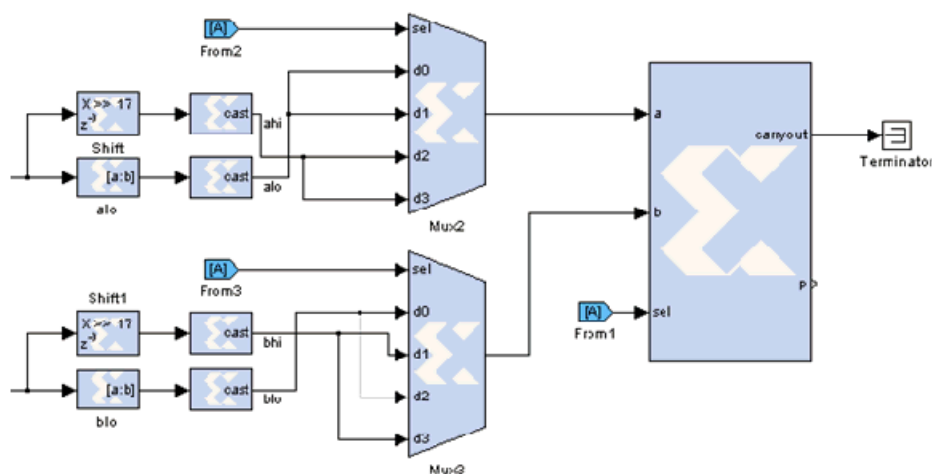



You can find the above complete model at the following pathname:

<sysgen\_path>/examples/dsp48/mult35x35/dsp48macro\_mult35x35.mdl

## LogiCORE™ Documentation

[LogiCORE IP DSP48 Macro 2.1](#)

## zDevice Support

Virtex-7 and Kintex-7, Virtex-6, Virtex-5, Virtex-4,  
Spartan-6, Spartan-3/XA, Spartan-3E/XA, Spartan-3A/3AN/3ADSP/XA

## See Also

The following topics give valuable insight into using and understanding the DSP48 block:

[DSP48 block](#)

[Generating Multiple Cycle-True Islands for Distinct Clocks](#)

[Xilinx XtremeDSP™](#)

## DSP48A

This block is listed in the following Xilinx Blockset libraries: *Index, DSP*.

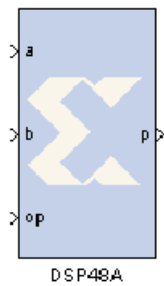

The Xilinx DSP48A block is an efficient building block for DSP applications that use Xilinx Spartan-3A DSP devices. For those familiar with the DSP48 and the DSP48E, the DSP48A is a 'light' version of primitive.

Key features for the DSP48A are a dedicated C-port and pre-adder. The DSP48A combines an 18-bit by 18-bit signed multiplier with a 48-bit adder and programmable mux to select the adder's input. Operations can be selected dynamically. Optional input and multiplier pipeline registers can be selected as well as registers for the subtract, carryin and opmode ports. The DSP48A block can also target devices that do not contain the DSP48A hardware primitive if the **Use synthesizable model** option is selected.

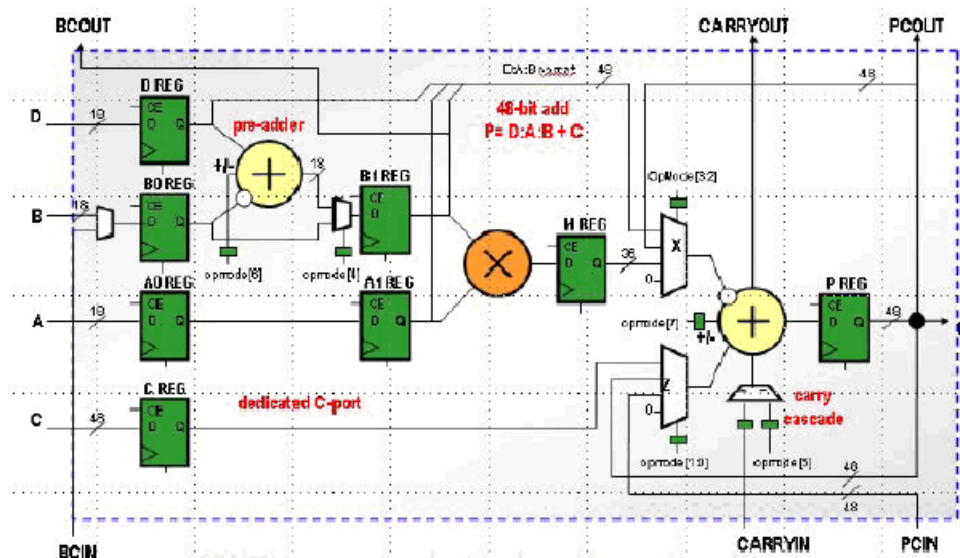

### Block Parameters

The block parameters dialog box can be invoked by double-clicking the icon in your Simulink model.

#### Basic tab

Parameters specific to the Basic tab are:

- Consolidate control port (opmode, carry\_in, preadd select, preadd subtract):** when selected, combines the opmode, subtract, preadd select and preadd subtract ports into one 8-bit port. Bits 0 to 3 are the opmode, bit 4 is the pre-add select port, bit 5 is the carry\_in (if the carry\_in is set to direct), bit 6 is the pre-adder subtract port, and bit 7 is the subtract port. This option should be used when the opmode block is used to generate a DSP48A instruction.
- Provide C port:** when selected, the c port is made available. Otherwise, the c port is tied to '0'.
- Provide D port:** when selected, the d port is made available. Otherwise, the d port is tied to '0'.
- Provide PCIN port:** when selected, the pcin port is exposed. The pcin port must be connected to the pcout port of another DSP48A block.

- **Provide PCOUT port:** when selected, the `pcout` output port is made available. The `pcout` port must be connected to the `pcin` port of another DSP48A block.
- **Provide BCOUT port:** when selected, the `bcout` output port is made available. The `bcout` port must be connected to the `b` port of another DSP48A block.
- **Provide CARRYIN port:** when selected, the `carryin` port is made available.
- **Provide CARRYOUT port:** when selected, the `carryout` port is made available. The `carryout` port must be connected to the `carryin` port of another DSP48A block.
- **Provide global reset port:** when selected, the port `rst` is made available. This port is connected to all available `reset` ports based on the pipeline selections.
- **Provide global enable port:** when selected, the port `en` is made available. This port is connected to all available `enable` ports based on the pipeline selections.

## Pipelining tab

Parameters specific to the Pipelining tab are:

- **Use A0 reg:** indicates whether the A0 reg should be used.
- **Use A1 reg:** indicates whether the A1 reg should be used.
- **Use B0 reg:** indicates whether the B0 reg should be used.
- **Use B1 reg:** indicates whether the B1 reg should be used.
- **Pipeline C:** indicates whether the input from the `c` port should be registered.
- **Pipeline D:** indicates whether the input from the `d` port should be registered.
- **Pipeline multiplier:** indicates whether the internal multiplier should register its output.
- **Pipeline P:** indicates whether the outputs `p` and `pcout` should be registered.
- **Pipeline opmode:** indicates whether the `opmode` port should be registered.
- **Pipeline carry in:** indicates whether the `carry in` port should be registered.

## Ports tab

Parameters specific to the Ports tab are:

- **Reset port for A:** when selected, a port `rst_a` is made available. This resets the pipeline register for port `a` when set to '1'.
- **Reset port for B:** when selected, a port `rst_b` is made available. This resets the pipeline register for port `b` when set to '1'.
- **Reset port for D:** when selected, a port `rst_d` is made available. This resets the pipeline register for port `c` when set to '1'.
- **Reset port for C:** when selected, a port `rst_c` is made available. This resets the pipeline register for port `c` when set to '1'.
- **Reset port for multiplier:** when selected, a port `rst_m` is made available. This resets the pipeline register for the internal multiplier when set to '1'.
- **Reset port for P:** when selected, a port `rst_p` is made available. This resets the output register when set to '1'.
- **Reset port for opmode:** when selected, a port `rst_opmode` is made available. This resets the pipeline register for the `opmode` port when set to '1'.
- **Reset port for carry in:** when selected, a port `rst_carryin` is made available. This resets the pipeline register for carry in when set to '1'.

- **Enable port for A:** when selected, an enable port `ce_a` for the port A pipeline register is made available.
- **Enable port for B:** when selected, an enable port `ce_b` for the port B pipeline register is made available.
- **Enable port for C:** when selected, an enable port `ce_c` for the port C register is made available.
- **Enable port for D:** when selected, an enable port `ce_d` for the port D pipeline register is made available.
- **Enable port for multiplier:** when selected, an enable port `ce_m` for the multiplier register is made available.
- **Enable port for P:** when selected, an enable port `ce_p` for the port P output register is made available.
- **Enable port for opmode:** when selected, the enable port `ce_opmode` is made available.
- **Enable port for carry in:** when selected, an enable port `ce_carry_in` for the carry in register is made available.

### Implementation tab

Parameters specific to the Implementation tab are:

- **Use synthesizable model:** when selected, the DSP48A is implemented from an RTL description which might not map directly to the DSP48A hardware. This is useful if a design using the DSP48A block is targeted at device families that do not contain DSP48A hardware primitives.

Other parameters used by this block are explained in the topic [Common Options in Block Parameter Dialog Boxes](#).

### See Also

The following topics give valuable insight into using and understanding the DSP48 block:

[DSP48 Macro](#)

[Generating Multiple Cycle-True Islands for Distinct Clocks](#)

[Virtex-5 XtremeDSP™ Design Considerations](#)

[Xilinx XtremeDSP™](#)

# DSP48E

This block is listed in the following Xilinx Blockset libraries: *Index, DSP.*

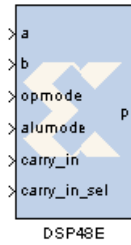

The Xilinx DSP48E block is an efficient building block for DSP applications that use Xilinx Virtex®-5 devices. The DSP48E combines an 18-bit by 25-bit signed multiplier with a 48-bit adder and programmable mux to select the adder's input.

Operations can be selected dynamically. Optional input and multiplier pipeline registers can be selected as well as registers for the alumode, carryin and opmode ports. The DSP48E block can also target devices that do not contain the DSP48E hardware primitive if the Use synthesizable model option is selected on the implementation tab.

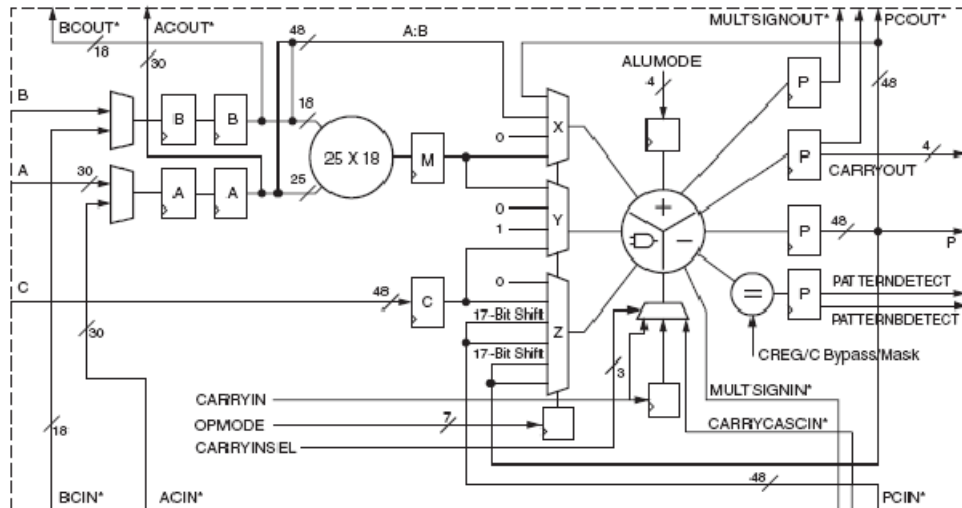

\*These signals are dedicated routing paths internal to the DSP48E column. They are not accessible via fabric routing resources.

## Block Parameters

The block parameters dialog box can be invoked by double-clicking the icon in your Simulink model.

### Basic tab

Parameters specific to the Basic tab are:

- **A or ACIN input:** specifies if the A input should be taken directly from the a port or from the cascaded acin port. The acin port can only be connected to another DSP48 block.
- **B or BCIN input:** specifies if the B input should be taken directly from the b port or from the cascaded bcin port. The bcin port can only be connected to another DSP48 block.

### Pattern Detection

- **Reset p register on pattern detection:** if selected and the pattern is detected, reset the p register on the next cycle

#### Pattern Input:

- ◆ **Pattern Input from c port:** when selected, the pattern used in pattern detection is read from the c port.
- ◆ **Using Pattern Attribute (48bit hex value):** value is used in pattern detection logic which is best described as an equality check on the output of the adder/subtractor/logic unit
- ◆ **Pattern attribute:** a 48-bit value that is used in the pattern detector.

#### Mask Input:

- ◆ **Mask input from c port:** when selected, the mask used in pattern detection is read from the c port.
- ◆ **Using Mask Attribute (48 bit hex value):** 48-bit value used to mask out certain bits during pattern detection.
- ◆ **Mask attribute:** a 48-bit value and used to mask out certain bits during a pattern detection. A value of 0 passes the bit, and a value of 1 masks out the bit.48-bit value and used to mask out certain bits during a pattern detection. A value of 0 passes the bit, and a value of 1 masks out the bit.

**Select rounding mask:** Selects special masks that can be used for symmetric or convergent rounding in the pattern detector. The choices are **Select mask**, **Mode1**, and **Mode2**.

Refer to following user guide for a detailed explanation of these parameters and attributes:  
[Virtex-5 FPGA XtremeDSP Design Considerations User Guide](#)

## Optional Ports tab

Parameters specific to the Optional Ports tab are:

**Consolidate control port:** when selected, combines the `opmode`, `alumode`, `carry_in` and `carry_in_sel` ports into one 15-bit port. Bits 0 to 6 are the `opmode`, bits 7 to 10 are the `alumode` port, bit 11 is the `carry_in` port, and bits 12 to 14 are the `carry_in_sel` port. This option should be used when the `opmode` block is used to generate a DSP48E instruction.

**Provide c port:** when selected, the c port is made available. Otherwise, the c port is tied to '0'.

**Provide global reset port:** when selected, the port `rst` is made available. This port is connected to all available reset ports based on the pipeline selections.

**Provide global enable port:** when selected, the optional `en` port is made available. This port is connected to all available enable ports based on the pipeline selections.

**Provide pcin port:** when selected, the `pcin` port is exposed. The `pcin` port must be connected to the `pcout` port of another DSP48 block.

**Provide carry cascade in port:** when selected, the carry cascade in port is exposed. This port can only be connected to a carry cascade out port on another DSP48E block.

**Provide multiplier sign cascade in port:** when selected, the multiplier sign cascade in port (`multsigncascin`) is exposed. This port can only be connected to a multiplier sign cascade out port of another DSP48E block.

**Provide carryout port:** when selected, the `carryout` output port is made available. When the mode of operation for the adder/subtractor is set to one 48-bit adder, the `carryout` port is 1-bit wide. When the mode of operation is set to two 24 bit adders, the `carryout` port is 2 bits wide. The MSB corresponds to the second adder's carryout and the LSB corresponds to the first adder's



carryout. When the mode of operation is set to four 12 bit adders, the `carryout` port is 4 bits wide with the bits corresponding to the addition of the 48 bit input split into 4 12-bit sections.

**Provide pattern detect port:** when selected, the pattern detection output port is provided. When the pattern, either from the mask or the `c` register, is matched the pattern detection port is set to '1'.

**Provide pattern bar detect port:** when selected, the pattern bar detection (`patternbdetect`) output port is provided. When the inverse of the pattern, either from the mask or the `c` register, is matched the pattern bar detection port is set to '1'.

**Provide overflow port:** when selected, the overflow output port is provided. This port indicates when the operation in the DSP48E has overflowed beyond the bit  $P[N]$  where  $N$  is between 1 and 46.  $N$  is determined by the number of 1s in the mask whether set by the GUI mask field or the `c` port input.

**Provide underflow port:** when selected, the underflow output port is provided. This port indicates when the operation in the DSP48E has underflowed. Underflow occurs when the number goes below  $-P[N]$  where  $N$  is determined by the number of 1s in the mask whether set by the GUI mask field or the `c` port input.

**Provide ACOUT port:** when selected, the `acout` output port is made available. The `acout` port must be connected to the `acin` port of another DSP48E block.

**Provide BCOUT port:** when selected, the `bcout` output port is made available. The `bcout` port must be connected to the `bcin` port of another DSP48E block.

**Provide PCOUT port:** when selected, the `pcout` output port is made available. The `pcout` port must be connected to the `pcin` port of another DSP48E block.

**Provide multiplier sign cascade out port:** when selected, the multiplier sign cascade out port (`multsigncascout`) is made available. This port can only be connected to the multiplier sign cascade in port of another DSP48E block and is used to support 96-bit accumulators/adders and subtracters which are built from two DSP48Es.

**Provide carry cascade out port:** when selected, the carry cascade out port (`carrycascout`) is made available. This port can only be connected to the carry cascade in port of another DSP48E block.

## Pipelining tab

Parameters specific to the Pipelining tab are:

- **Length of a/acin pipeline:** specifies the length of the pipeline on input register A. A pipeline of length 0 removes the register on the input.
- **Length of b/bCIN pipeline:** specifies the length of the pipeline for the `b` input whether it is read from `b` or `bcin`.
- **Length of acout pipeline:** specifies the length of the pipeline between the `a/acin` input and the `acout` output port. A pipeline of length 0 removes the register from the `acout` pipeline length. Must be less than or equal to the length of the `a/acin` pipeline.
- **Length of bcout pipeline:** specifies the length of the pipeline between the `b/bcin` input and the `bcout` output port. A pipeline of length 0 removes the register from the `bcout` pipeline length. Must be less than or equal to the length of the `b/bcin` pipeline.
- **Pipeline c:** indicates whether the input from the `c` port should be registered.
- **Pipeline p:** indicates whether the outputs `p` and `pcout` should be registered.
- **Pipeline multiplier:** indicates whether the internal multiplier should register its output.
- **Pipeline opmode:** indicates whether the `opmode` port should be registered.

- **Pipeline alumode:** indicates whether the alumode port should be registered.
- **Pipeline carry in:** indicates whether the carry in port should be registered.
- **Pipeline carry in select:** indicates whether the carry in select port should be registered

## Reset/Enable Ports

Parameters specific to the Reset/Enable tab are:

- **Reset port for a/acin:** when selected, a port rst\_a is made available. This resets the pipeline register for port a when set to '1'.
- **Reset port for b/bcin:** when selected, a port rst\_b is made available. This resets the pipeline register for port b when set to '1'.
- **Reset port for c:** when selected, a port rst\_c is made available. This resets the pipeline register for port c when set to '1'.
- **Reset port for multiplier:** when selected, a port rst\_m is made available. This resets the pipeline register for the internal multiplier when set to '1'.
- **Reset port for P:** when selected, a port rst\_p is made available. This resets the output register when set to '1'.
- **Reset port for carry in:** when selected, a port rst\_carryin is made available. This resets the pipeline register for carry in when set to '1'.
- **Reset port for alumode:** when selected, a port rst\_alumode is made available. This resets the pipeline register for the alumode port when set to '1'.
- **Reset port for controls (opmode and carry\_in\_sel):** when selected, a port rst\_ctrl is made available. This resets the pipeline register for the opmode register (if available) and the carry\_in\_sel register (if available) when set to '1'.
- **Enable port for first a/acin register:** when selected, an enable port ce\_a1 for the first a pipeline register is made available.
- **Enable port for second a/acin register:** when selected, an enable port ce\_a2 for the second a pipeline register is made available.
- **Enable port for first b/bcin register:** when selected, an enable port ce\_b1 for the first b pipeline register is made available.
- **Enable port for second b/bcin register:** when selected, an enable port ce\_b2 for the second b pipeline register is made available.
- **Enable port for c:** when selected, an enable port ce\_c for the port C register is made available.
- **Enable port for multiplier:** when selected, an enable port ce\_m for the multiplier register is made available.
- **Enable port for p:** when selected, an enable port ce\_p for the port P output register is made available.
- **Enable port for carry in:** when selected, an enable port ce\_carry\_in for the carry in register is made available.
- **Enable port for alumode:** when selected, an enable port ce\_alumode for the alumode register is made available.
- **Enable port for multiplier carry in:** when selected, an enable port mult\_carry\_in for the multiplier register is made available.
- **Enable port for controls (opmode and carry\_in\_sel):** when selected, the enable port ce\_ctrl is made available. The port ce\_ctrl controls the opmode and carry in select registers.

## Implementation

Parameters specific to the Implementation tab are:

- **Use synthesizable model:** when selected, the DSP48E is implemented from an RTL description which might not map directly to the DSP48E hardware. This is useful if a design using the DSP48E block is targeted at device families that do not contain DSP48E hardware primitives.
- **Mode of operation for the adder/subtractor:** this mode can be used to implement small add-subtract functions at high speed and lower power with less logic utilization. The adder and subtracter in the adder/subtracted/logic unit can also be split into two 24-bit fields or four 12-bit fields. This is achieved by setting the mode of operation to "Two 24-bit adders" or "Four 12-bit adders". See the Virtex®-5 XtremeDSP Design Considerations for more details.
- **Use adder only:** when selected, the block is optimized in hardware for maximum performance without using the multiplier. If an instruction using the multiplier is encountered in simulation, an error is reported.

Other parameters used by this block are explained in the topic [Common Options in Block Parameter Dialog Boxes](#).

## See Also

The following topics give valuable insight into using and understanding the DSP48 block:

[Virtex-5 FPGA XtremeDSP Design Considerations User Guide](#)

[DSP48 Macro](#)

[Generating Multiple Cycle-True Islands for Distinct Clocks](#)

[Virtex-5 XtremeDSP™ Design Considerations](#)

[Xilinx XtremeDSP™](#)

## DSP48E1

This block is listed in the following Xilinx Blockset libraries: Index, DSP.

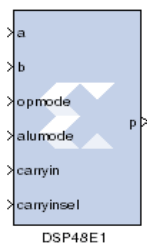

The Xilinx DSP48E1 block is an efficient building block for DSP applications that use Xilinx Virtex®-6 and 7 series devices. Enhancements to the DSP48E1 slice provide improved flexibility and utilization, improved efficiency of applications, reduced overall power consumption, and increased maximum frequency. The high performance allows designers to implement multiple slower operations in a single DSP48E1 slice using time-multiplexing methods.

The DSP48E1 slice supports many independent functions. These functions include multiply, multiply accumulate (MACC), multiply add, three-input add, barrel shift, wide-bus multiplexing, magnitude comparator, bit-wise logic functions, pattern detect, and wide counter. The architecture also supports cascading multiple DSP48E1 slices to form wide math functions, DSP filters, and complex arithmetic without the use of general FPGA logic..

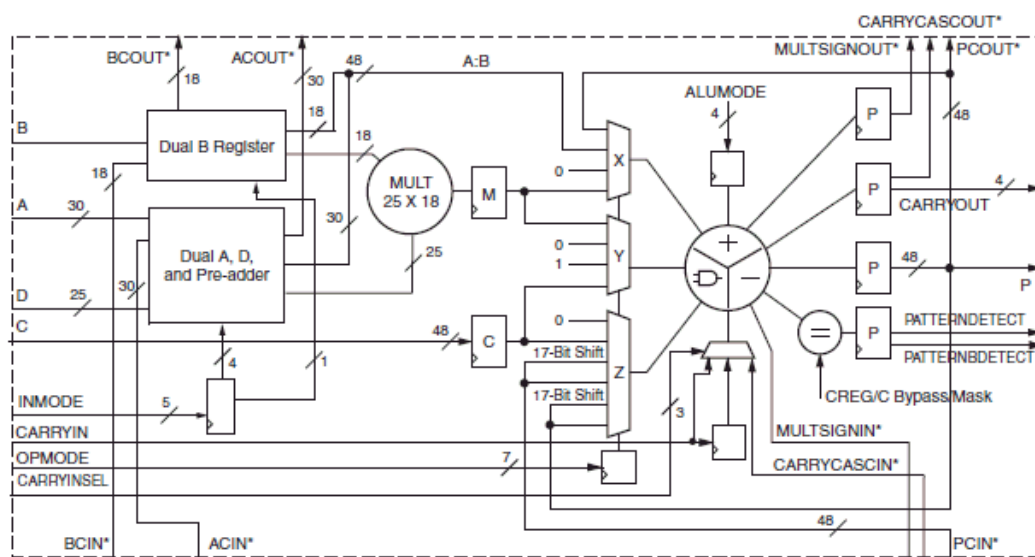

\*These signals are dedicated routing paths internal to the DSP48E1 column. They are not accessible via fabric routing resources.

### Block Parameters

The block parameters dialog box can be invoked by double-clicking the icon in your Simulink model.

#### Basic tab

Parameters specific to the Basic tab are:

##### Input configuration

- **A or ACIN input:** specifies if the A input should be taken directly from the a port or from the cascaded acin port. The acin port can only be connected to another DSP48 block.
- **B or BCIN input:** specifies if the B input should be taken directly from the b port or from the cascaded bcin port. The bcin port can only be connected to another DSP48 block.

##### DSP48E1 data-path configuration

- **SIMD Mode of Adder/Subtractor/Accumulator:** this mode can be used to implement small add-subtract functions at high speed and lower power with less logic utilization. The adder and

subtractor in the adder/subtracted/logic unit can also be split into **Two 24-bit Units** or **Four 12-bit Units**.

- **Do not use multiplier:** when selected, the block is optimized in hardware for maximum performance without using the multiplier. If an instruction using the multiplier is encountered in simulation, an error is reported.
- **Use dynamic multiplier mode:** When selected, it instructs the block to use the dynamic multiplier mode. This indicates that the block is switching between A\*B and A:B operations on the fly and therefore needs to get the worst-case timing of the two paths.
- **Use preadder:** Use the 25-bit D data input to the pre-adder or alternative input to the multiplier. The pre-adder implements  $D + A$  as determined by the INMODE3 signal.

#### Pattern Detection

- **Reset p register on pattern detection:** if selected and the pattern is detected, reset the p register on the next cycle

#### Pattern Input:

- ◆ **Pattern Input from c port:** when selected, the pattern used in pattern detection is read from the c port.
- ◆ **Using Pattern Attribute (48bit hex value):** value is used in pattern detection logic which is best described as an equality check on the output of the adder/subtractor/logic unit
- ◆ **Pattern attribute:** a 48-bit value that is used in the pattern detector.

#### Mask Input:

- ◆ **Mask input from c port:** when selected, the mask used in pattern detection is read from the c port.
- ◆ **Using Mask Attribute (48 bit hex value):** 48-bit value used to mask out certain bits during pattern detection.
- ◆ **Mode1:** Selects rounding\_mode 1.
- ◆ **Mode2:** Selects rounding\_mode 2.

Refer to following user guide for a detailed explanation of these parameters and attributes:

[Virtex-6 FPGA DSP48E1 Slice User Guide](#)

## Optional Ports tab

Parameters specific to the Optional Ports tab are:

**Consolidate control port:** when selected, combines the `opmode`, `alumode`, `carry_in`, `carry_in_sel`, and `inmode` ports into one 20-bit port. Bits 0 to 6 are the `opmode`, bits 7 to 10 are the `alumode` port, bit 11 is the `carry_in` port, bits 12 to 14 are the `carry_in_sel` port, and bits 15-19 are the `inmode` bits. This option should be used when the `opmode` block is used to generate a DSP48E instruction.

**Provide c port:** when selected, the c port is made available. Otherwise, the c port is tied to '0'.

**Provide global reset port:** when selected, the port `rst` is made available. This port is connected to all available reset ports based on the pipeline selections.

**Provide global enable port:** when selected, the optional `en` port is made available. This port is connected to all available enable ports based on the pipeline selections.

**Provide pcin port:** when selected, the `pcin` port is exposed. The `pcin` port must be connected to the `pcout` port of another DSP48 block.

**Provide carry cascade in port:** when selected, the carry cascade in port is exposed. This port can only be connected to a carry cascade out port on another DSP48E block.

**Provide multiplier sign cascade in port:** when selected, the multiplier sign cascade in port (multsigncascin) is exposed. This port can only be connected to a multiplier sign cascade out port of another DSP48E block.

**Provide carryout port:** when selected, the carryout output port is made available. When the mode of operation for the adder/subtractor is set to one 48-bit adder, the carryout port is 1-bit wide. When the mode of operation is set to two 24 bit adders, the carryout port is 2 bits wide. The MSB corresponds to the second adder's carryout and the LSB corresponds to the first adder's carryout. When the mode of operation is set to four 12 bit adders, the carryout port is 4 bits wide with the bits corresponding to the addition of the 48 bit input split into 4 12-bit sections.

**Provide pattern detect port:** when selected, the pattern detection output port is provided. When the pattern, either from the mask or the c register, is matched the pattern detection port is set to '1'.

**Provide pattern bar detect port:** when selected, the pattern bar detection (patternbdetect) output port is provided. When the inverse of the pattern, either from the mask or the c register, is matched the pattern bar detection port is set to '1'.

**Provide overflow port:** when selected, the overflow output port is provided. This port indicates when the operation in the DSP48E has overflowed beyond the bit P[N] where N is between 1 and 46. N is determined by the number of 1s in the mask whether set by the GUI mask field or the c port input.

**Provide underflow port:** when selected, the underflow output port is provided. This port indicates when the operation in the DSP48E has underflowed. Underflow occurs when the number goes below  $-P[N]$  where N is determined by the number of 1s in the mask whether set by the GUI mask field or the c port input.

**Provide ACOUT port:** when selected, the acout output port is made available. The acout port must be connected to the acin port of another DSP48E block.

**Provide BCOUT port:** when selected, the bcout output port is made available. The bcout port must be connected to the bcin port of another DSP48E block.

**Provide PCOUT port:** when selected, the pcout output port is made available. The pcout port must be connected to the pcin port of another DSP48E block.

**Provide multiplier sign cascade out port:** when selected, the multiplier sign cascade out port (multsigncascout) is made available. This port can only be connected to the multiplier sign cascade in port of another DSP48E block and is used to support 96-bit accumulators/adders and subtractors which are built from two DSP48Es.

**Provide carry cascade out port:** when selected, the carry cascade out port (carrycascout) is made available. This port can only be connected to the carry cascade in port of another DSP48E block.

## Pipelining tab

Parameters specific to the Pipelining tab are:

- **Length of a/acin pipeline:** specifies the length of the pipeline on input register A. A pipeline of length 0 removes the register on the input.
- **Length of b/bCIN pipeline:** specifies the length of the pipeline for the b input whether it is read from b or bcin.

- **Length of acout pipeline:** specifies the length of the pipeline between the a/acin input and the acout output port. A pipeline of length 0 removes the register from the acout pipeline length. Must be less than or equal to the length of the a/acin pipeline.
- **Length of bcout pipeline:** specifies the length of the pipeline between the b/bcin input and the bcout output port. A pipeline of length 0 removes the register from the bcout pipeline length. Must be less than or equal to the length of the b/bcin pipeline.
- **Pipeline c:** indicates whether the input from the c port should be registered.
- **Pipeline p:** indicates whether the outputs p and pcout should be registered.
- **Pipeline multiplier:** indicates whether the internal multiplier should register its output.
- **Pipeline opmode:** indicates whether the opmode port should be registered.
- **Pipeline alumode:** indicates whether the alumode port should be registered.
- **Pipeline carry in:** indicates whether the carry in port should be registered.
- **Pipeline carry in select:** indicates whether the carry in select port should be registered
- **Pipeline preadder input register d:** indicates to add a pipeline register to the d input.
- **Pipeline preadder output register ad:** indicates to add a pipeline register to the ad output.
- **Pipeline INMODE register:** indicates to add a pipeline register to the INMODE input.

## Reset/Enable Ports

Parameters specific to the Reset/Enable tab are:

### Provide Reset Ports

- **Reset port for a/acin:** when selected, a port rst\_a is made available. This resets the pipeline register for port a when set to '1'.
- **Reset port for b/bcin:** when selected, a port rst\_b is made available. This resets the pipeline register for port b when set to '1'.
- **Reset port for c:** when selected, a port rst\_c is made available. This resets the pipeline register for port c when set to '1'.
- **Reset port for multiplier:** when selected, a port rst\_m is made available. This resets the pipeline register for the internal multiplier when set to '1'.
- **Reset port for P:** when selected, a port rst\_p is made available. This resets the output register when set to '1'.
- **Reset port for carry in:** when selected, a port rst\_carryin is made available. This resets the pipeline register for carry in when set to '1'.
- **Reset port for alumode:** when selected, a port rst\_alumode is made available. This resets the pipeline register for the alumode port when set to '1'.
- **Reset port for controls (opmode and carry\_in\_sel):** when selected, a port rst\_ctrl is made available. This resets the pipeline register for the opmode register (if available) and the carry\_in\_sel register (if available) when set to '1'.
- **Reset port for d and ad:**
- **Reset port for INMODE:**

### Provide Enable Ports

- **Enable port for first a/acin register:** when selected, an enable port ce\_a1 for the first a pipeline register is made available.
- **Enable port for second a/acin register:** when selected, an enable port ce\_a2 for the second a pipeline register is made available.

- **Enable port for first b/bcin register:** when selected, an enable port ce\_b1 for the first b pipeline register is made available.
- **Enable port for second b/bcin register:** when selected, an enable port ce\_b2 for the second b pipeline register is made available.
- **Enable port for c:** when selected, an enable port ce\_c for the port C register is made available.
- **Enable port for multiplier:** when selected, an enable port ce\_m for the multiplier register is made available.
- **Enable port for p:** when selected, an enable port ce\_p for the port P output register is made available.
- **Enable port for carry in:** when selected, an enable port ce\_carry\_in for the carry in register is made available.
- **Enable port for alumode:** when selected, an enable port ce\_alumode for the alumode register is made available.
- **Enable port for multiplier carry in:** when selected, an enable port mult\_carry\_in for the multiplier register is made available.
- **Enable port for controls (opmode and carry\_in\_sel):** when selected, the enable port ce\_ctrl is made available. The port ce\_ctrl controls the opmode and carry in select registers.
- **Enable port for d:** when selected, an enable port is added input register d.
- **Enable port for ad:** when selected, an enable port is add for the preadder output register ad.
- **Enable port for INMODE:** when selected, an enable port is added for the INMODE register.

## Implementation

Parameters specific to the Implementation tab are:

- **Use synthesizable model:** when selected, the DSP48E is implemented from an RTL description which might not map directly to the DSP48E hardware. This is useful if a design using the DSP48E block is targeted at device families that do not contain DSP48E hardware primitives.

Other parameters used by this block are explained in the topic [Common Options in Block Parameter Dialog Boxes](#).

## See Also

The following topics give valuable insight into using and understanding the DSP48 block:

[Virtex-6 FPGA DSP48E1 Slice User Guide](#)

[DSP48 Macro](#)

[Generating Multiple Cycle-True Islands for Distinct Clocks](#)

[Xilinx XtremeDSP™](#)



## Dual Port RAM

This block is listed in the following Xilinx Blockset libraries: Control Logic, Memory, Floating-Point and Index.



The Xilinx Dual Port RAM block implements a random access memory (RAM). Dual ports enable simultaneous access to the memory space at different sample rates using multiple data widths.

### Block Interface

The block has two independent sets of ports for simultaneous reading and writing. Independent address, data, and write enable ports allow shared access to a single memory space. By default, each port set has one output port and three input ports for address, input data, and write enable. Optionally, you can also add a port enable and synchronous reset signal to each input port set.

### Form Factors

The Dual Port RAM block also supports various Form Factors (FF). Form factor is defined as:

$$FF = W_B / W_A \text{ where } W_B \text{ is data width of Port B and } W_A \text{ is Data Width of Port A.}$$

The Depth of port B ( $D_B$ ) is inferred from the specified form factor as follows:

$$D_B = D_A / FF.$$

The data input ports on Port A and B can have different arithmetic type and binary point position for a form factor of 1. For form factors greater than 1, the data input ports on Port A and Port B should have an unsigned arithmetic type with binary point at 0. The output ports, labeled A and B, have the same types as the corresponding input data ports.

The location in the memory block can be accessed for reading or writing by providing the valid address on each individual address port. A valid address is an unsigned integer from 0 to  $d-1$ , where  $d$  denotes the RAM depth (number of words in the RAM) for the particular port. An attempt to read past the end of the memory is caught as an error in simulation. The initial RAM contents can be specified through a block parameter. Each write enable port must be a boolean value. When the WE port is 1, the value on the data input is written to the location indicated by the address line.

### Write Mode

The output during a write operation depends on the write mode. When the WE is 0, the output port has the value at the location specified by the address line. During a write operation (WE asserted), the data presented on the input data port is stored in memory at the location selected by the port's address input. During a write cycle, you can configure the behavior of each data out port A and B to one of the following choices:

- **Read after write**
- **Read before write**
- **No read on write**

The write modes can be described with the help of the figure below. In the figure, the memory has been set to an initial value of 5 and the address bit is specified as 4. When using **No read on write** mode, the output is unaffected by the address line and the output is the same as the last output when the WE was 0. For the other two modes, the output is obtained from the location specified by the address line, and hence is the value of the location being written to. This means that the output can be the old value which corresponds to **Read after write**.

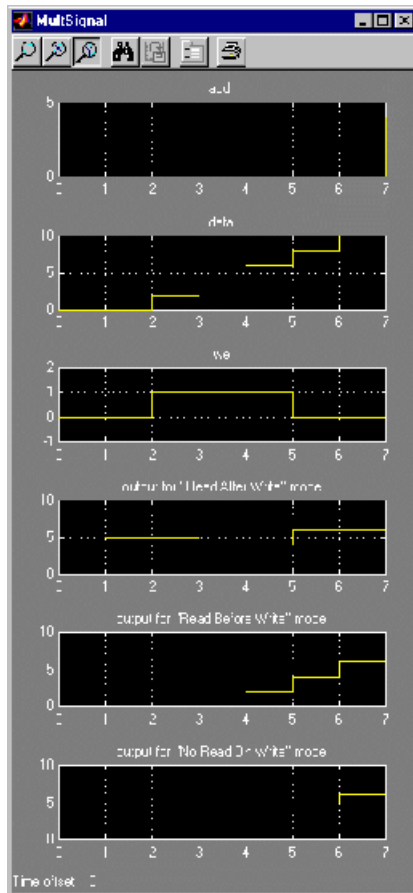

## Collision Behavior

The result of simultaneous access to both ports is described below:

### Read-Read Collisions

If both ports read simultaneously from the same memory cell, the read operation is successful.

### Write-Write Collisions

If both ports try to write simultaneously to the same memory cell, both outputs are marked as invalid (nan).

### Write-Read Collisions

This collision occurs when one port writes and the other reads from the same memory cell. While the memory contents are not corrupted, the validity of the output data on the read port depends on the Write Mode of the write port.

- If the write port is in **Read before write** mode, the other port can reliably read the old memory contents.
- If the write port is in **Read after write** or **No read on write**, data on the output of the read port is invalid (nan).

You can set the Write Mode of each port using the Advanced tab of the block parameters dialog box.

## Maximum Timing Performance

When implementing dual port RAM blocks on Virtex®4, Virtex-5, Virtex-6 and Spartan®-3A DSP devices, maximum timing performance is possible if the following conditions are satisfied:

- The option **Provide synchronous reset port for port A output register** is un-checked.
- The option **Provide synchronous reset port for port B output register** is un-checked.
- The option **Depth** is less than 16,384.
- The option **Latency** is set to 2 or higher.

## Block Parameters

The block parameters dialog box can be invoked by double-clicking the icon in your Simulink model.

### Basic tab

Parameters specific to the Basic tab are:

- **Depth**: specifies the number of words in the memory for Port A, which must be a positive integer. The Port B depth is inferred from the form factor specified by the input data widths.
- **Initial value vector**: specifies the initial memory contents. The size and precision of the elements of the initial value vector are based on the data format specified for Port A. When the vector is longer than the RAM, the vector's trailing elements are discarded. When the RAM is longer than the vector, the RAM's trailing words are set to zero. The initial value vector is saturated and rounded according to the precision specified on the data port A of RAM.
- **Memory Type**: option to select between block and distributed RAM. The distributed dual port RAM is always set to use port A in Read Before Write mode and port B in read-only mode.
- **Initial value for port A output Register**: specifies the initial value for port A output register. The initial value is saturated and rounded according to the precision specified on the data port

A of RAM. The option to set initial value is available only for Spartan®-3, Virtex®-4, Virtex-5, Virtex-6, and Spartan-3A DSP devices.

- **Initial value for port B output register:** specifies the initial value for port B output register. The initial value is saturated and rounded according to the precision specified on the data port B of RAM. The option to set initial value is available only for Spartan®-3, Virtex-4, Virtex-5, Virtex-6, and Spartan-3A DSP devices.
- **Provide synchronous reset port for port A output register:** when selected, allows access to the reset port available on the port A output register of the Block RAM. The reset port is available only when the latency of the Block RAM is set to 1.
- **Provide synchronous reset port for port B output register:** when selected, allows access to the reset port available on the port B output register of the Block RAM. The reset port is available only when the latency of the Block RAM is set to 1.
- **Provide enable port for port A:** when selected, allows access to the enable port for port A. The enable port is available only when the latency of the block is greater than or equal to 1.
- **Provide enable port for port B:** when selected, allows access to the enable port for port B. The enable port is available only when the latency of the block is greater than or equal to 1.

### Advanced tab

Parameters specific to the Advanced tab are:

Port A:

- Read after write
- Read before write
- No read on write

Port B:

- Read after write
- Read before write
- No read on write

Other parameters used by this block are explained in the topic [Common Options in Block Parameter Dialog Boxes](#).

## Xilinx LogiCORE

This block always uses a Xilinx LogiCORE™: Dual Port Block Memory or Distributed Memory. For the dual port block memory, the address width must be equal to  $\text{ceil}(\log_2(d))$  where  $d$  denotes the memory depth. The maximum width of data words in the block memory depends on the depth specified; the maximum depth depends on the device family targeted. The tables above provide the maximum data word width for a given block memory depth.

## LogiCORE™ Documentation

[LogiCORE IP Block Memory Generator v6.3](#)

[LogiCORE IP Distributed Memory Generator v6.3](#)

[LogiCORE IP Floating-Point Operator v6.1](#)

## Device Support

Zynq-7000, Artix-7, Virtex-7, Kintex-7, Virtex-6, Virtex-5, Virtex-4, Spartan-6, Spartan-3E/XA, Spartan-3/XA, Spartan-3A/3AN/3A DSP

Floating-Point support is restricted to the following devices:

Zynq-7000, Artix-7, Virtex-7, Kintex-7, Virtex-6, Virtex-5, Virtex-4, Spartan-6

## Maximum Width for Various Depth Ranges (Virtex®/Virtex-E/Spartan®-3)

Depth	Width
2 to 2048	256
2049 to 4096	192
4097 to 8192	96
8193 to 16K	48
16K+1 to 32K	24
32K+1 to 64K	12
64K+1 to 128K	6
128K+1 to 256K	3

## Width for Various Depth Ranges (Virtex-4/Virtex-5/Spartan-3A DSP)

Depth	Width
2 to 8192	256
8193 to 16K	192
16K+1 to 32K	96
32K+1 to 64K	48
64K+1 to 128K	24
128K+1 to 256K	12
256K+1 to 512K	6
512K+1 to 1024K	3

When the distributed memory parameter is selected, LogiCORE™ Distributed Memory is used. The depth must be between 16 and 65536, inclusive for Spartan®-3, Virtex®-4, Virtex-5, Virtex-6, and Spartan-3A DSP devices; depth must be between 16 to 4096, inclusive for the other FPGA families. The word width must be between 1 and 1024, inclusive.

## EDK Processor

This block is listed in the following Xilinx Blockset libraries: *Index, Control Logic*.



The EDK Processor block allows user logic developed in System Generator to be attached to embedded processor systems created using the Xilinx Embedded Development Kit (EDK).

The EDK Processor block supports two design flows: *EDK pcore generation* and *HDL netlisting*. In the *HDL netlisting* flow, the embedded processor systems created using the EDK are imported into System Generator models. In *EDK pcore generation* flow, the System Generator models are exported as a pcore, which can be later imported into EDK projects and attached to embedded processors.

### Memory Map Interface

The EDK Processor block automatically generates a [Shared Memory](#)-based memory map interface for the embedded processor and the user logic developed using System Generator to communicate with each other. C device drivers are also automatically generated by the EDK Processor block in order for the embedded processors to access the attached shared memories.

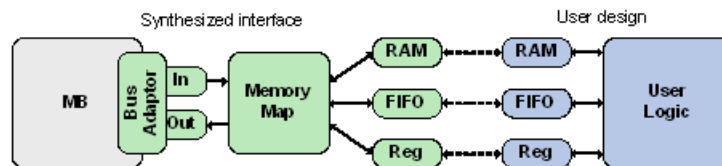

The figure above shows the memory map interface generated by the EDK Processor block. The user logic developed in System Generator is connected to a set of shared memories. These shared memories can be added to the EDK Processor block through the block dialog box described below. The EDK Processor block automatically generates the other half of the shared memories and a memory map interface that connects the shared memories to the MicroBlaze™ processor through either a slave PLB v4.6 interface, or an AXI4 interface, depending on the user selection. By default, the PLB v4.6 interface is selected. C device drivers are also automatically generated so that the MicroBlaze processor can get access to these shared-memories, by their names or their locations on the memory map interface.

The memory map interface is generated by the EDK Processor block in either the EDK pcore generation flow or HDL netlisting flow. In the EDK pcore generation flow, only the hardware to the right of the Bus Adaptor is netlisted into the exported pcore. In the HDL netlisting flow, all the hardware shown in the figure above (including the MicroBlaze processor, the memory map interface, the shared memories, and the user logic) is netlisted together, just like other System Generator designs.

Refer to [Hardware Software Co-Design](#) for more details about the design and simulation techniques offered by the EDK Processor block.

## Block Parameters

The block parameters dialog box can be invoked by double-clicking the icon in your Simulink model.

### Basic tab

Parameters specific to the Basic tab are as follows:

- **Configure processor for:** The EDK Processor block can be configured for **EDK pc core generation** or **HDL netlisting**. The EDK Import Wizard runs automatically when HDL netlisting is chosen.
- **Import:** Launch the EDK Import Wizard.
- **XPS project:** Name of the imported XMP project file (.xmp file). Click **Import...** to browse to a new XMP project file.
- **Memory Map:** A view that shows the shared memories associated with the processor. Right-clicking on the Memory Map items reveals a menu of possible operations on the shared memories: configure, delete, or re-synchronize the shared memories, refresh the tree view. Re-synchronizing shared memories helps to keep the shared memories used by the user logic consistent with the shared memories automatically generated by the EDK Processor block.

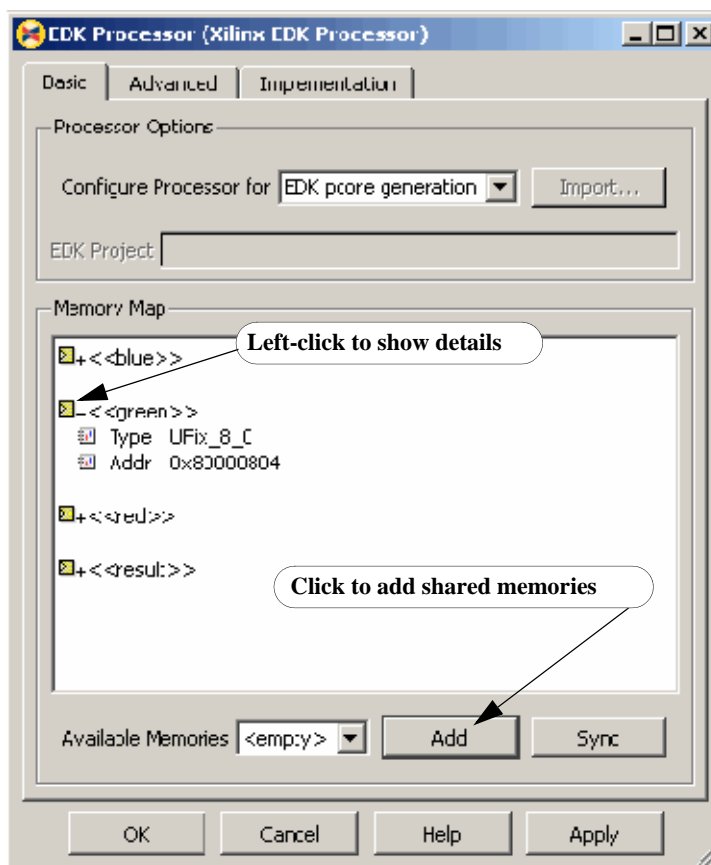

**Note:** The EDK Processor block does not support Shared Memory blocks with spaces in their names.



## Advanced tab

Parameters specific to the Advanced tab are as follows:

### Port Interface

Refer to the topic [Exposing Processor Ports to System Generator](#) for more information.

## Implementation tab

### Memory Map Interface

Parameters specific to the Implementation tab are as follows:

#### Memory Map Interface

- ◆ **Bus Type:** Select **PLB v4.6 (Processor Local Bus v4.6)** or **AXI4 (Advanced eXtensible Interface 4)** as the peripheral bus. The default is **PLB v4.6 (Processor Local Bus)**.

If PLB v4.6 is selected, the target MicroBlaze™ processor must have a PLB v4.6 bus properly connected to the DPLB interface. If AXI4 is selected, the target MicroBlaze processor must have an AXI interconnect properly connected to the M\_AXI\_DP interface.

For HDL netlisting mode, the bus type is automatically selected by System Generator when importing an XPS project. The selection is determined based on the interconnect type of the target MicroBlaze processor.

- ◆ **Base Address:** The bus address space is automatically adjusted and minimized. If you know where you want the bus address space to start, enter the address and click **Lock**. Otherwise, the base address is automatically determined for you.
- ◆ **Dual Clocks:** In the EDK Import flow, an extra clock will appear in the top-level netlist called `plb_clk` (or `axi_aclk` for AXI4). The Processor and the PLB v4.6 bus adaptor (AXI4 interconnect) is driven by the `plb_clk`, and the rest of the System Generator design is driven by the `sysgen_clk`.

When netlisting for hardware co-simulation, the `plb_clk` (`axi_aclk`) is driven directly by the board's input clock, while the `sysgen_clk` is controlled by the hardware co-simulation module.

When exporting as a pc core, the generated pc core has an additional clock port that must be connected in XPS to drive the System Generator design. Refer to topic [Asynchronous Support for EDK Processors](#) for more information.

- ◆ **Register Read-Back:** Typically interfaces on the memory-map are uni-directional; the registers can either be *read-from* or *write-to* from the processor. When **Register Read-Back** is enabled, From-Registers that can be written-to from the processor can also be read-from. Turning on this functionality will add more entries to the memory map and will incur a speed and area penalty.

### Constraints

- ◆ **Constraint file:** Pathname to the modified UCF file that automatically generated by System Generator. After you successfully import an XPS project into System Generator, and if the XPS project contains a UCF (User Constraint File), System Generator will parse that UCF file and generate a modified UCF file based on the settings of the EDK Processor block. You can examine the modifications made by System Generator by clicking the **View** button to the right of the **Constraint file** text field. Should there be any undesired modifications, you can modify the original UCF file and re-import the XPS project.
- **Inherit Device Type from System Generator:** This option only works when the EDK Processor block is set in HDL Import mode. When enabled, during netlisting time, System Generator will push the device type selected on the System Generator Token to XPS and re-synthesize a new processor subsystem. This option can cause netlisting to error out if the imported XPS system uses board-specific resources or contain constraints that tie the system to a specific board or device.

### Software tab

- **Initial Program** Allows an Initial program (.ELF file) to be set on the EDK Processor block. When a bitstream containing an EDK Processor is created using the Bitstream or Hardware Co-simulation compilation target, the initial program file pointed to in this field is loaded onto the program memory of the processor after the bitstream has been created.
- **Enable Co-Debug with Xilinx SDK (Beta):** When this option is checked (the default), there is an extra co-debug circuit that is automatically inserted into the design under test. This co-debug circuit allows System Generator and the MicroBlaze to get synchronized during simulation.

You should uncheck this co-debug option when you are done with co-debug. This will remove the co-debug circuit from the final netlist and bitstream.

Other parameters used by this block are explained in the topic [Common Options in Block Parameter Dialog Boxes](#).

### Known Issues

- Only one EDK Processor block per design is supported.
- Only one MicroBlaze™ processor per design is supported. Use of multiple MicroBlaze processors per design and the embedded PowerPC® processor are not supported.
- The Multiple Subsystem Generator block does not support designs that include an EDK Processor block
- For the AXI4 interface, only in-frame burst transfers are supported; cross-frame burst transfer is currently not supported. That is, each burst frame of data must be predicated by an address.
- AXI4 is not supported on Virtex 5, Spartan 5, and older devices.

### Online Documentation for the MicroBlaze Processor

More information for the MicroBlaze™ processor can be found at the following address:

[http://www.xilinx.com/products/design\\_resources/proc\\_central/microblaze.htm](http://www.xilinx.com/products/design_resources/proc_central/microblaze.htm)

# Expression

This block is listed in the following Xilinx Blockset libraries: *Basic Elements, Control Logic, Math, and Index.*

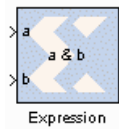

The Xilinx Expression block performs a bitwise logical expression.

The expression is specified with operators described in the table below. The number of input ports is inferred from the expression. The input port labels are identified from the expression, and the block is subsequently labeled accordingly. For example, the expression:  $\sim((a1 \mid a2) \& (b1 \wedge b2))$  results in the following block with 4 input ports labeled 'a1', 'a2', 'b1', and 'b2'.

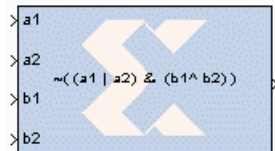

The expression is parsed and an equivalent statement is written in VHDL (or Verilog). Shown below, in decreasing order of precedence, are the operators that can be used in the Expression block.

Operator	Symbol
Precedence	()
NOT	~
AND	&
OR	
XOR	^

## Block Parameters

The block parameters dialog box can be invoked by double-clicking the icon in your Simulink model.

### Basic tab

Parameters specific to the Basic tab are as follows:

- **Expression:** Bitwise logical expression.
- **Align Binary Point:** specifies that the block must align binary points automatically. If not selected, all inputs must have the same binary point position.

Other parameters used by this block are explained in the topic [Common Options in Block Parameter Dialog Boxes.](#)

## Fast Fourier Transform 7.1

This block is listed in the following Xilinx Blockset libraries: *DSP and Index*.



The Xilinx Fast Fourier Transform 7.1 block implements an efficient algorithm for computing the Discrete Fourier Transform (DFT).

The  $N$ -point (where,  $N = 2^m$ ,  $m = 3-16$ ) forward or inverse DFT (IDFT) is computed on a vector of  $N$  complex values represented using data widths from 8 to 34, inclusive. The transform computation uses the Cooley-Tukey decimate-in-time algorithm for the Burst I/O architectures, and Decimation In Frequency for the Pipelined and Streaming I/O architectures. The FFT general formula is explained below.

### Theory of Operation

The FFT is a computationally efficient algorithm for computing a Discrete Fourier Transform (DFT) of sample sizes that are a positive integer power of 2. The DFT of a sequence is defined as:

$$X(k) = \sum_{n=0}^{N-1} x(n)e^{-jn k 2\pi / N} \quad k = 0, \dots, N-1$$

where  $N$  is the transform length and  $j$  is the square root of -1. The inverse DFT (IDFT) is:

$$x(n) = \frac{1}{N} \sum_{k=0}^{N-1} X(k)e^{jn k 2\pi / N} \quad n = 0, \dots, N-1$$

### Block Interface

#### Input Signals:

xn_re	real component of input data stream. The signal driving xn_re can be a signed data type of width $S$ with binary point at $S-1$ , where $S$ is a value between 8 and 34, inclusive. eg: Fix_8_7, Fix_34_33
xn_im	imaginary component of input data stream. The signal driving xn_im can be a signed data type of width $S$ with binary point at $S-1$ , where $S$ is a value between 8 and 34, inclusive. eg: Fix_8_7, Fix_34_33
start	marks the beginning of each data frame. The start signal can be asserted as a pulse to start processing an input data frame or it can be tied to high. The signal driving start must be Bool.

<code>unload</code>	is used to read the output in natural order. The <code>unload</code> port is available only for implementing the Radix-4 Burst I/O, Radix-2 Burst I/O, or Radix-2 Lite Burst I/O architecture and Natural order output ordering is selected. The <code>unload</code> signal is sampled after the block is done processing the input frame. The block outputs data in natural order after the <code>unload</code> signal is asserted high. The data is output a few cycles after <code>unload</code> is asserted - it is not immediate. If the output ordering is Natural Order, the user must always use <code>unload</code> to unload the data. If <code>start</code> is asserted before asserting <code>unload</code> , a new transform is started and the last frame is overwritten. If output is in bit-/digit-reversed order, there is no <code>unload</code> pin, and <code>start</code> must be asserted to both <code>unload</code> the previous frame and <code>load</code> a new frame simultaneously.
<code>fwd_inv</code>	0 for inverse transform, 1 for forward transform. The signal driving <code>fwd_inv</code> must be Bool. By default, the FFT is configured for forward transform.
<code>fwd_inv_we</code>	when asserted, loads the transform type from the input port <code>fwd</code> for the next input data frame. The signal driving <code>fwd_inv_we</code> must be Bool.
<code>nfft</code>	provides the point size for the next input data frame. The <code>nfft</code> port is available only when the checkbox for Run Time Configurable Transform Length is selected. The signal driving <code>nfft</code> must be unsigned signal of width 5 with binary point at 0, <code>UFix_5_0</code> . <b>Point size of the transform:</b> NFFT can be the size of the transform or any smaller point size. For example, a 1024-point FFT can compute point sizes 1024, 512, 256, and so on. The value of NFFT is $\log_2$ (point size). This port is only used with run-time configurable transform point size
<code>nfft_we</code>	when asserted, resets the current operation of the block and loads the point size from the input port <code>nfft</code> for the next input data frame. The <code>nfft_we</code> port is available only when the checkbox for Run Time Configurable Transform Length is selected. The signal driving <code>nfft_we</code> must be Bool.
<code>cp_len</code>	provides the cyclic prefix length size for the next input data frame. The <code>cp_len</code> port is available only when the checkbox for Cyclic prefix insertion is selected and the Output ordering is set to Natural Order. The signal driving <code>cp_len</code> must be unsigned signal of width N with binary point at 0, where N is $\log_2$ of maximum number of sample points, <code>UFix_N_0</code> . <code>cp_len</code> can be any number from zero to one less than the point size.
<code>cp_len_we</code>	when asserted, loads the cyclic prefix length from the input port <code>cp_len</code> for the next input data frame. The <code>cp_len_we</code> port is available only when the checkbox for Cyclic prefix insertion is selected and the Output ordering is set to Natural Order. The signal driving <code>cp_len_we</code> must be Bool
<code>scale_sch</code>	provides the scaling schedule to be used for the input data frame. The <code>scale_sch</code> port is available only for Fixed Point Scaled mode. Refer to page 12 of the LogiCORE data sheet for a full description of this port.
<code>scale_sch_we</code>	when asserted, loads the scaling schedule from the input port <code>scale_sch</code> for the next input data frame. The <code>scale_sch_we</code> port is available only for Fixed Point Scaled mode. The signal driving <code>scale_sch_we</code> must be Bool.

### Output Signals:

<code>xk_re</code>	real component of output data stream. <code>xk_re</code> is the same width and modes as the input <code>xn_re</code> . The width of <code>xk_re</code> signal grows left from the <code>xn_re</code> binary point in the Unscaled mode by $(1+\log_2N)$ where $N$ is the maximum point size. This signal is valid only when <code>dv</code> goes high.
<code>xk_im</code>	imaginary component of output data stream. <code>xk_im</code> is the same as the input <code>xn_im</code> for Scaled and Block Floating Point mode. The width of <code>xk_im</code> signal grows left from the <code>xn_im</code> binary point in the Unscaled mode by $(1+\log_2N)$ where $N$ is the maximum point size. This signal is valid only when <code>dv</code> goes high. <b>Note:</b> Both <code>xk_re</code> and <code>xk_im</code> signals must have the same data type.
<code>xn_index</code>	marks the index of the input data. The <code>xn_index</code> signal is marked as an unsigned signal of width $\log_2N$ with binary point at 0. ( $N$ is the maximum point size.)
<code>xk_index</code>	marks the index of the output data. The <code>xk_index</code> signal is marked as an unsigned signal of width $\log_2N$ with binary point at 0. ( $N$ is the maximum point size.)
<code>rfd</code>	active high after the <code>start</code> signal is asserted till the <code>xn_index</code> count reaches $N-1$ . ( $N$ is the maximum point size.) The <code>rfd</code> signal is marked as Bool.
<code>busy</code>	active high when the block is processing the current input data frame. The <code>busy</code> signal is marked as Bool.
<code>dv</code>	high indicates that the output data is valid. The <code>dv</code> signal is Bool.
<code>edone</code>	active high one sample period before the block is ready to output the processed data frame. <code>edone</code> is marked as Bool.
<code>done</code>	active high when the block is ready to output the processed data frame. <code>done</code> is marked as Bool.
<code>cpv</code>	marks the output data as valid when cyclic prefix data is presented at the output. The <code>cpv</code> port is available only when the checkbox for Cyclic prefix insertion is selected and the Output ordering is set to Natural Order. <code>cpv</code> signal is marked as Bool.
<code>rfs</code>	active high when the block is ready to process the start input to begin data loading. The <code>rfs</code> port is available only for Pipelined Streaming I/O implementation, when the checkbox for Cyclic prefix insertion is selected and the Output ordering is set to Natural Order. <code>rfs</code> signal is marked as Bool.
<code>ovflo</code>	marks the output data frame with active high signal if an overflow condition was detected while processing the input data frame in the Scaled mode. This signal is valid only when <code>dv</code> goes high. The <code>ovflo</code> signal is marked as Bool.
<code>blk_exp</code>	specifies the exponent value for the output data frame in Block Floating Point mode. The <code>blk_exp</code> signal is only valid when <code>dv</code> goes high. <code>blk_exp</code> is marked as an unsigned signal of width 5 with binary point at 0. This signal is valid only when <code>dv</code> goes high.

## Block Parameters

The block parameters dialog box can be invoked by double-clicking the icon in your Simulink model.

## Basic tab

Parameters specific to the Basic tab are as follows:

- Transform length: one of  $N = 2^{(3..16)} = 8 - 65536$ .
- **Implementation Options:** choose between `pipelined_streaming_io`; `radix_4_burst_io`; `radix_2_burst_io`; `radix_2_lite_burst_io`; or `automatically_select`.

**Target clock frequency(MHz):** Enter the target clock frequency.

**Target data throughput(MSPS):** Enter the target throughput.

Transform Length Options

- **Run Time Configurable Transform Length:** The transform length can be set through the `nfft` port if this option is selected. Valid settings and the corresponding transform sizes are provided in the section titled Transform Size in the associated [LogiCORE IP Fast Fourier Transform v7.1 Data Sheet](#)

## Advanced tab

Parameters specific to the Advanced tab are as follows:

Precision Options

- **Phase factor width:** choose a value between 8 and 34, inclusive to be used as bit widths for phase factors.

Scaling options

Select between **Unscaled**, **Scaled**, and **Block floating point** output data types.

Rounding modes

- **Rounding mode:** choose between **Truncation** and **Convergent rounding** to be applied at the output of each rank.

Output ordering

- **Output ordering:** choose between **Bit/Digit reversed order** or **Natural order** output.
- **Cyclic prefix insertion:** option to have optional input ports `cp_len` and `cp_len_we` for dynamically specifying the cyclic prefix insertion for a transform output frame. Cyclic prefix insertion takes a section of the output of the FFT and prefixes it to the beginning of the transform. The resultant output data consists of the cyclic prefix (a copy of the end of the output data) followed by the complete output data, all in natural order. Cyclic prefix insertion is only available when output ordering is Natural Order.

Optional Pins

- **en:** Clock Enable – Activates an optional enable (`en`) pin on the block. When the enable signal is not asserted, the block holds its current state until the enable signal is asserted again or the reset signal is asserted. Reset signal has precedence over the enable signal. The enable signal has to run at a multiple of the block's sample rate. The signal driving the enable port must be Boolean.
- **rst:** Reset – Activates an optional reset (`rst`) pin on the block. When the reset signal is asserted the block goes back to its initial state. Reset signal has precedence over the optional enable signal available on the block. The reset signal has to run at a multiple of the block's sample rate. The signal driving the reset port must be Boolean.
- **ovflo:** option to have an optional output port `ovflo` when Scaled scaling option is selected.

Input Data Timing

- **No offset:** the first sample pair is applied with the `start` pulse and read in on the transition from `xn_index=0` to `xn_index=1`.
- **3 clock cycle offset (pre-v7.0 behavior):** the first sample pair is read in on the transition from `xn_index=3` to `xn_index=4` (3 cycles after `start` was applied).

## Implementation tab

Parameters specific to the Implementation tab are as follows:

### Memory Options

- **Data:** option to choose between **Block RAM** and **Distributed RAM**. This option is available only for sample points 8 through 1024. This option is not available for Pipelined Streaming I/O implementation.
- **Phase factors:** choose between **Block RAM** and **Distributed RAM**. This option is available only for sample points 8 till 1024. This option is not available for Pipelined Streaming I/O implementation.
- **Number of stages using Block RAM:** store data and phase factor in **Block RAM** and partially in **Distributed RAM**. This option is available only for the Pipelined Streaming I/O implementation.
- **Reorder buffer:** choose between **Block RAM** and **Distributed RAM** up to 1024 points transform size.
- **Hybrid Memories:** click check box to **Optimize Block RAM count using hybrid memories**

### Optimize Options

- **Complex Multipliers:** choose one of the following
  - ◆ Use CLB logic
  - ◆ Use 3-multiplier structure (resource optimization)
  - ◆ Use 4-multiplier structure (performance optimization)
- **Butterfly arithmetic:** choose one of the following:
  - ◆ Use CLB logic
  - ◆ Use XTremeDSP slices

Other parameters used by this block are explained in the topic [Common Options in Block Parameter Dialog Boxes](#).

## Block Timing

To better understand the FFT blocks control behavior and timing, please consult the core data sheet.

## LogiCORE™ Documentation

[LogiCORE IP Fast Fourier Transform v7.1](#)

[LogiCORE IP Floating-Point Operator v6.1](#)

## Device Support

Virtex-7 and Kintex-7, Virtex-6, Virtex-5, Virtex-4,  
Spartan-6, Spartan-3/XA, Spartan-3E/XA, Spartan-3A/3AN/3A DSP/XA

Floating-Point support is restricted to the following devices:



Virtex-7, Kintex-7, Virtex-6, Spartan-6

## Fast Fourier Transform 8.0

This block is listed in the following Xilinx Blockset libraries: AXI4, DSP, Floating-Point and Index.



The Xilinx Fast Fourier Transform 8.0 block implements the Cooley-Tukey FFT algorithm, a computationally efficient method for calculating the Discrete Fourier Transform (DFT). In addition, the block provides an AXI4-Stream-compliant interface for Virtex-6 and Spartan-6 devices.

The FFT computes an N-point forward DFT or inverse DFT (IDFT) where,  $N = 2^m$ ,  $m = 3-16$ . For fixed-point inputs, the input data is a vector of N complex values represented as dual  $b_x$ -bit two's complement numbers, that is,  $b_x$  bits for each of the real and imaginary components of the data sample, where  $b_x$  is in the range 8 to 34 bit, inclusive. Similarly, the phase factors  $b_w$  can be 8 to 34 bits wide.

For single-precision floating-point inputs, the input data is a vector of N complex values represented as dual 32-bit floating-point numbers with the phase factors represented as 24- or 25-bit fixed-point numbers.

Refer to the topic [AXI Interface](#) for more detailed information on the AXI Interface.

### Theory of Operation

The FFT is a computationally efficient algorithm for computing a Discrete Fourier Transform (DFT) of sample sizes that are a positive integer power of 2. The DFT of a sequence is defined as:

$$X(k) = \sum_{n=0}^{N-1} x(n)e^{-jn k 2\pi / N} \quad k = 0, \dots, N-1$$

where  $N$  is the transform length and  $j$  is the square root of -1. The inverse DFT (IDFT) is:

$$x(n) = \frac{1}{N} \sum_{k=0}^{N-1} X(k)e^{jn k 2\pi / N} \quad n = 0, \dots, N-1$$

### AXI Ports that are Unique to this Block

This Sysgen Generator block exposes the AXI CONFIG channel as a group of separate ports based on sub-field names. The sub-field ports are described as follows:

#### Configuration Channel Input Signals:

config_tdata_scale_sch	A sub-field port that represents the <b>Scaling Schedule</b> field in the Configuration Channel vector. Refer to the <a href="#">LogiCORE IP Fast Fourier Transform v8.0 Product Specification</a> starting on page 51 for an explanation of the bits in this field.
config_tdata_fwd_inv	A sub-field port that represents the <b>Forward Inverse</b> field in the Configuration Channel vector. Refer to the <a href="#">LogiCORE IP Fast Fourier Transform v8.0 Product Specification</a> starting on page 50 for an explanation of the bits in this field.
config_tdata_nfft	A sub-field port that represents the <b>Transform Size (NFFT)</b> field in the Configuration Channel vector. Refer to the <a href="#">LogiCORE IP Fast Fourier Transform v8.0 Product Specification</a> starting on page 50 for an explanation of the bits in this field.

`config_tdata_cp_len` A sub-field port that represents the **Cyclic Prefix Length (CP\_LEN)** field in the Configuration Channel vector. Refer to the [LogiCORE IP Fast Fourier Transform v8.0 Product Specification](#) starting on page 50 for an explanation of the bits in this field.

This Sysgen Generator block exposes the AXI DATA channel as separate ports based on the real and imaginary sub-field names. The sub-field ports are described as follows:

#### DATA Channel Input Signals:

`data_tdata_xn_im` Represents the imaginary component of the Data Channel. The signal driving `xn_im` can be a signed data type of width `S` with binary point at `S-1`, where `S` is a value between 8 and 34, inclusive. eg: `Fix_8_7`, `Fix_34_33`.

**Note:** Both `xn_re` and `xn_im` signals must have the same data type.

Refer to the [LogiCORE IP Fast Fourier Transform v8.0 Product Specification](#) starting on page 53 for an explanation of the bits in this field.

`data_tdata_xn_re` Represents the real component of the Data Channel. The signal driving `xn_re` can be a signed data type of width `S` with binary point at `S-1`, where `S` is a value between 8 and 34, inclusive. eg: `Fix_8_7`, `Fix_34_33`.

**Note:** Both `xn_re` and `xn_im` signals must have the same data type.

Refer to the [LogiCORE IP Fast Fourier Transform v8.0 Product Specification](#) starting on page 53 for an explanation of the bits in this field.

## Block Parameters

The block parameters dialog box can be invoked by double-clicking the icon in your Simulink model.

### Basic tab

Parameters specific to the Basic tab are as follows:

Transform Length

- **Transform\_length:** one of  $N = 2^{(3..16)} = 8 - 65536$ .

Implementation Options

- **Target Clock Frequency(MHz):** Enter the target clock frequency.
- **Target Data Throughput(MSPS):** Enter the target throughput.
- **Implementation Options:** choose between `automatically_select`, `pipelined_streaming_io`, `radix_4_burst_io`, `radix_2_burst_io`, or `radix_2_lite_burst_io`.

Transform Length Options

**Run Time Configurable Transform Length:** The transform length can be set through the `nfft` port if this option is selected. Valid settings and the corresponding transform sizes are provided in the section titled Transform Size in the [LogiCORE IP Fast Fourier Transform v8.0 Product Specification](#)

### Advanced tab

Parameters specific to the Advanced tab are as follows:

Precision Options

- **Phase Factor Width:** choose a value between 8 and 34, inclusive to be used as bit widths for phase factors.

#### Scaling Options

Select between **Unscaled**, **Scaled**, and **Block Floating Point** output data types.

#### Rounding Modes

- **Truncation** to be applied at the output of each rank
- **Convergent Rounding** to be applied at the output of each rank.

#### Control Signals

- **ACLKEN:** Enables the clock enable (aclken) pin on the core. All registers in the core are enabled by this control signal.
- **ARESETn:** Active-low synchronous clear input that always takes priority over ACLKEN. A minimum ARESETn active pulse of two cycles is required, since the signal is internally registered for performance. A pulse of one cycle resets the core, but the response to the pulse is not in the cycle immediately following.

#### Output Ordering

- **Cyclic Prefix Insertion:** Cyclic prefix insertion takes a section of the output of the FFT and prefixes it to the beginning of the transform. The resultant output data consists of the cyclic prefix (a copy of the end of the output data) followed by the complete output data, all in natural order. Cyclic prefix insertion is only available when output ordering is Natural Order.

When cyclic prefix insertion is used, the length of the cyclic prefix can be set frame-by-frame without interrupting frame processing. The cyclic prefix length can be any number of samples from zero to one less than the point size. The cyclic prefix length is set by the CP\_LEN field in the Configuration channel. For example, when  $N = 1024$ , the cyclic prefix length can be from 0 to 1023 samples, and a CP\_LEN value of 0010010110 produces a cyclic prefix consisting of the last 150 samples of the output data.

- Output ordering - choose between **Bit/Digit Reversed Order** or **Natural Order** output.

#### Throttle Schemes

Select the trade off between performance and data timing requirements.

- **Real Time:** This mode typically gives a smaller and faster design, but has strict constraints on when data must be provided and consumed
- **Non Real Time:** This mode has no such constraints, but the design might be larger and slower.

#### Optional Output Fields

- **XK\_INDEX:** The XK\_INDEX field (if present in the Data Output channel) gives the sample number of the XK\_RE/XK\_IM data being presented at the same time. In the case of natural order outputs, XK\_INDEX increments from 0 to (point size) -1. When bit reversed outputs are used, XK\_INDEX covers the same range of numbers, but in a bit (or digit) reversed manner
- **OVFLO:** The Overflow (OVFLO) field in the Data Output and Status channels is only available when the Scaled arithmetic is used. OVFLO is driven High during unloading if any point in the data frame overflowed.

For a multichannel core, there is a separate OVFLO field for each channel. When an overflow occurs in the core, the data is wrapped rather than saturated, resulting in the transformed data becoming unusable for most applications

#### Block Icon Display

**Display shortened port names:** On by default. When unchecked, `data_tvalid`, for example, becomes `m_axis_data_tvalid`.

## Implementation tab

Parameters specific to the Implementation tab are as follows:

### Memory Options

- **Data:** option to choose between **Block RAM** and **Distributed RAM**. This option is available only for sample points 8 through 1024. This option is not available for Pipelined Streaming I/O implementation.
- **Phase Factors:** choose between **Block RAM** and **Distributed RAM**. This option is available only for sample points 8 till 1024. This option is not available for Pipelined Streaming I/O implementation.
- **Number Of Stages Using Block RAM:** store data and phase factor in **Block RAM** and partially in **Distributed RAM**. This option is available only for the Pipelined Streaming I/O implementation.
- **Reorder Buffer:** choose between **Block RAM** and **Distributed RAM** up to 1024 points transform size.
- **Hybrid Memories:** click check box to **Optimize Block RAM Count Using Hybrid Memories**

### Optimize Options

- **Complex Multipliers:** choose one of the following
  - ◆ Use CLB logic
  - ◆ Use 3-multiplier structure (resource optimization)
  - ◆ Use 4-multiplier structure (performance optimization)
- **Butterfly Arithmetic:** choose one of the following:
  - ◆ Use CLB logic
  - ◆ Use XTremeDSP Slices

Other parameters used by this block are explained in the topic [Common Options in Block Parameter Dialog Boxes](#).

## Block Timing

To better understand the FFT blocks control behavior and timing, please consult the core data sheet.

## How to Migrate from Fast Fourier Transform 7.1 to Fast Fourier Transform 8.0

### Design description

This example shows how to migrate from the non-AI4 FFT block to an AXI4 FFT block using the same or similar block parameters. Some of the parameters between non-AXI4 and AXI4 versions might not be identical exactly due to some changes in certain features and block interfaces. The following model is used to illustrate the design migration between these blocks. For more detail, refer to the datasheet of this IP core.

The Input Source subsystem generates `tdata_imag`, `tdata_real`, and `dout_valid` signals for the Inverse FFT block. The outputs of these signals are then been reconstructed to the original shapes by the Forward FFT.

### Example showing how to migrate to AXI4 FFT IP block

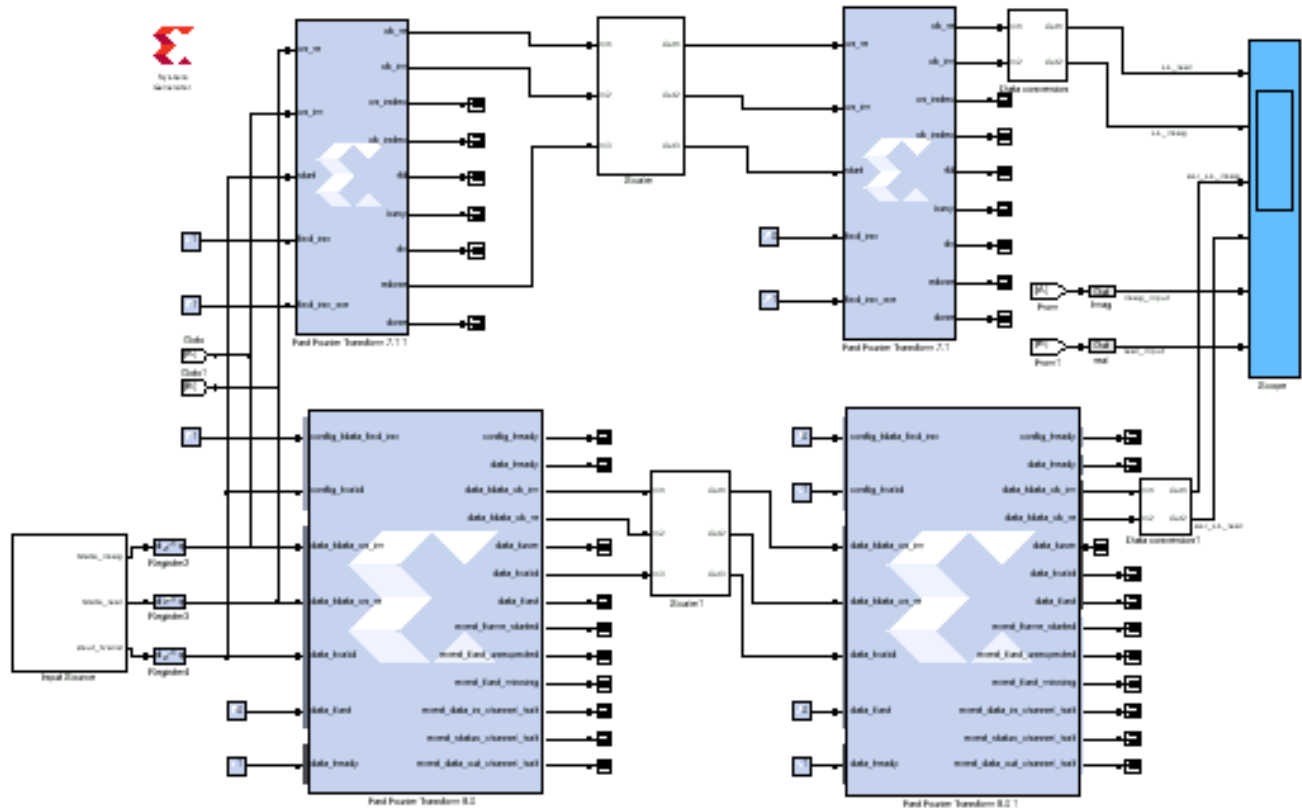

Notice that there are some differences in latency between the AXI4 and non-AXI4 versions and this is probably due to some internal differences in implementation. However, both the amplitude and frequency are correct.

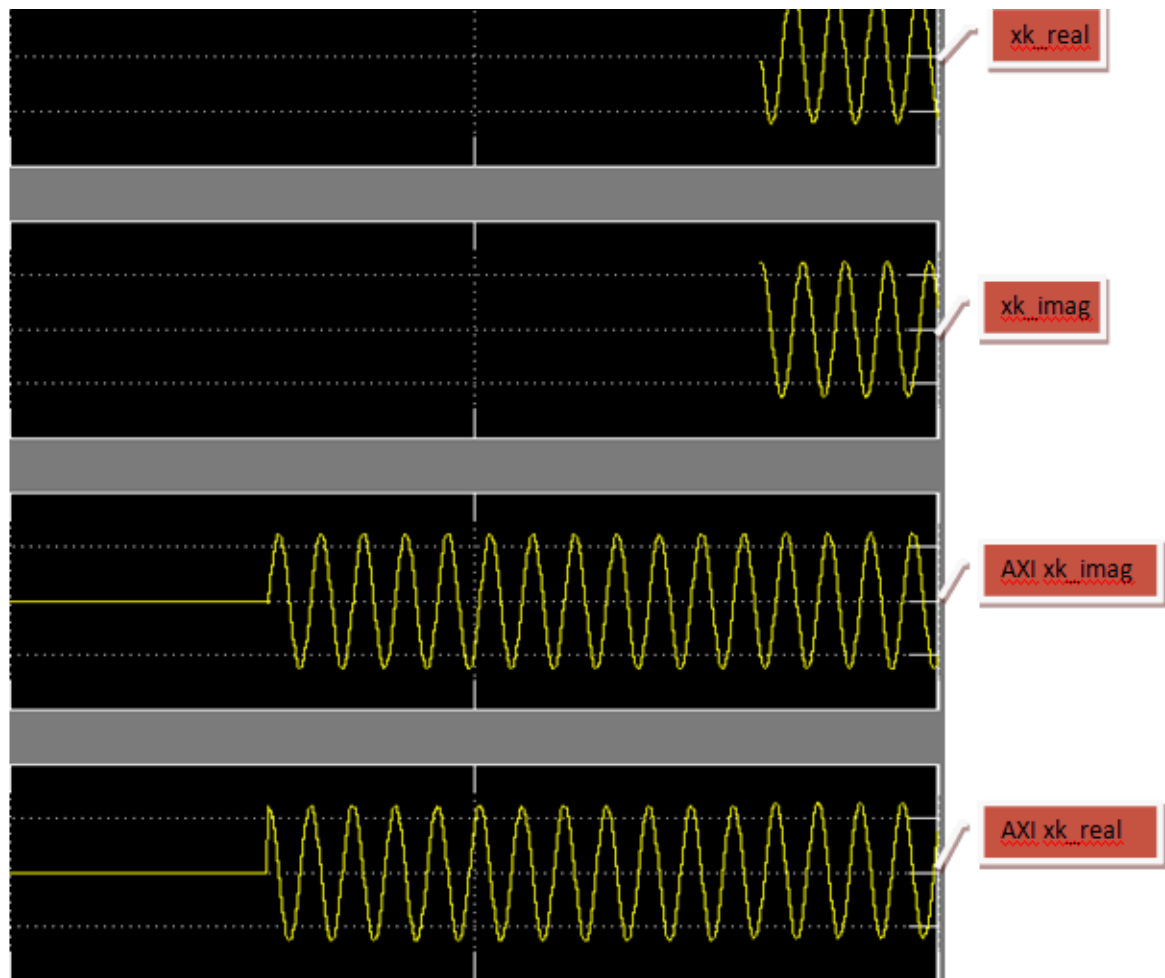

#### Data path and control signals:

Data paths and control signals between the AXI and non-AXI versions are very similar and there are no significant differences, some of which is described as follows:

`config_tdata_fwd_inv`: this signal replaces the `fwd_inv` signal, which is used to configure the FFT as Inverse or Forward

`config_tvalid`: is used to signal that it is able to transfer the configuration data

`data_tlast` and `data_tready`: these two input control signals are not used and pulled to proper logic.

`data_tvalid`: is used to gate both the input and output signals between Master and Slave blocks

### LogiCORE™ Documentation

[LogiCORE IP Fast Fourier Transform v8.0](#)

[LogiCORE IP Floating-Point Operator v6.1](#)

## Device Support

Virtex-7, Kintex-7, Virtex-6, Spartan-6



## FDATool

This block is listed in the following Xilinx Blockset libraries: *DSP, Tools, and Index*

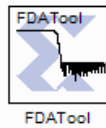

The Xilinx FDATool block provides an interface to the FDATool software available as part of the MATLAB Signal Processing Toolbox.

The block does not function properly and should not be used if the Signal Processing Toolbox is not installed. This block provides a means of defining an FDATool object and storing it as part of a System Generator model. FDATool provides a powerful means for defining digital filters with a graphical user interface.

### Example of Use

Copy an FDATool block into a subsystem where you would like to define a filter. Double-clicking the block icon opens up an FDATool session and graphical user interface. The filter is stored in an data structure internal to the FDATool interface block, and the coefficients can be extracted using MATLAB helper functions provided as part of System Generator. The function call `xlfd_a_numerator('FDATool')` returns the numerator of the transfer function (e.g., the impulse response of a finite impulse response filter) of the FDATool block named 'FDATool'. Similarly, the helper function `xlfd_a_denominator('FDATool')` retrieves the denominator for a non-FIR filter.

A typical use of the FDATool block is as a companion to an FIR filter block, where the Coefficients field of the filter block is set to `xlfd_a_numerator('FDATool')`. An example is shown in the following diagram:

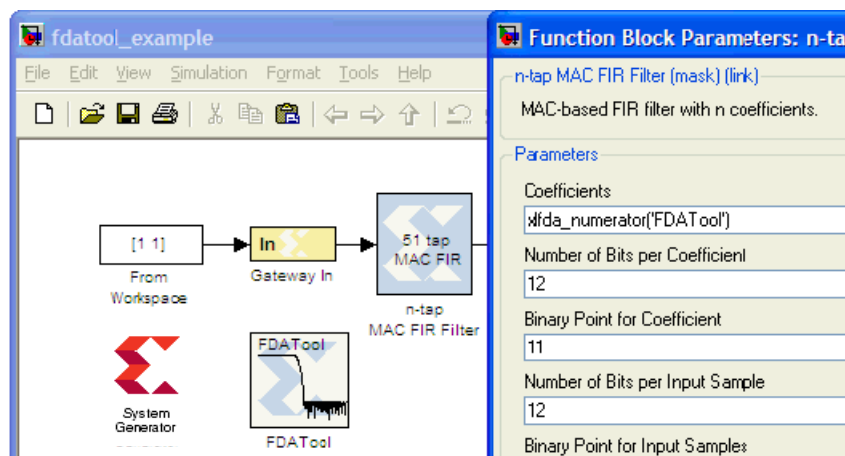

Note that `xlfd_a_numerator()` can equally well be used to initialize a memory block or a 'coefficient' variable for a masked subsystem containing an FIR filter.

This block does not use any hardware resources

### FDA Tool Interface

Double-clicking the icon in your Simulink model opens up an FDATool session and its graphical user interface. Upon closing the FDATool session, the underlying FDATool object is stored in the UserData parameter of the Xilinx FDATool block. Use the `xlfd_a_numerator()` helper function and `get_param()` to extract information from the object as desired.

## FIFO

This block is listed in the following Xilinx Blockset libraries: Control Logic, Floating-Point, Memory, and Index.



The Xilinx FIFO block implements an FIFO memory queue.

Values presented at the module's data-input port are written to the next available empty memory location when the write-enable input is one. By asserting the read-enable input port, data can be read out of the FIFO using the data output port (`dout`) in the order in which they were written. The FIFO can be implemented using block RAM, distributed RAM, SRL or built-in FIFO.

The `full` output port is asserted to one when no unused locations remain in the module's internal memory. The `percent_full` output port indicates the percentage of the FIFO that is full, represented with user-specified precision. When the `empty` output port is asserted the FIFO is empty.

### Block Parameters

The block parameters dialog box can be invoked by double-clicking the icon in your Simulink model.

#### Basic tab

Parameters specific to the Basic tab are:

FIFO Implementation:

**Memory Type:** This block implements FIFOs built from block RAM, distributed RAM, shift registers, or the 7 series, Virtex-6 and Virtex-5 FPGA built-in FIFOs. Memory primitives are arranged in an optimal configuration based on the selected width and depth of the FIFO. The following table provides best-use recommendations for specific design requirements.

	Independent Clocks	Common Clock	Small Buffering	Medium-Large Buffering	High Performance	Minimal Resources
Zynq-7000, 7 Series, Virtex-6, and Virtex-5 FPGA with Built-in FIFO	✓	✓		✓	✓	✓
Block RAM	✓	✓		✓	✓	✓
Shift Register		✓	✓		✓	
Distributed RAM	✓	✓	✓		✓	

**Performance Options:**

- **Standard FIFO:** FIFO will operate in Standard Mode.
- **First Word Fall Through:** FIFO will operate in First-Word Fall-Through (FWFT) mode. The First-Word Fall-Through feature provides the ability to look-ahead to the next word available from the FIFO without issuing a read operation. When data is available in the FIFO, the first word falls through the FIFO and appears automatically on the output. FWFT is useful in applications that require low-latency access to data and to applications that require throttling based on the contents of the data that are read. FWFT support is included in FIFOs created with block RAM, distributed RAM, or built-in FIFOs in 7 series, Virtex-6 or Virtex-5 devices.

Implementation Options:

- **Use Embedded Registers (when possible):**  
In 7 series, Virtex-6, Virtex-5 and Virtex-4 FPGA block RAM and FIFO macros, embedded output registers are available to increase performance and add a pipeline register to the macros. This feature can be leveraged to add one additional cycle of latency to the FIFO core (DOUT bus and VALID outputs) or implement the output registers for FWFT FIFOs. The embedded registers available in 7 series, and Virtex-6 FPGAs can be reset (DOUT) to a default or user programmed value for common clock built-in FIFOs. See the topic **Embedded Registers in block RAM and FIFO Macros** in the [LogiCORE IP FIFO Generator 9.2 Product Specification](#).

**Depth:** specifies the number of words that can be stored. Range 16-64K.

**Bits of precision to use for %full signal:** specifies the bit width of the %full port. The binary point for this unsigned output is always at the top of the word. Thus, if for example precision is set to one, the output can take two values: 0.0 and 0.5, the latter indicating the FIFO is at least 50% full.

Optional Ports:

- **Provide reset port:** Add reset port to the block.
- **Provide enable port:** Add enable port to the block.
- **Provide data count port:** Add data count port to the block. Provides the number of words in the FIFO.
- **Provide percent full port:** Add a percent full output port to the block. Indicates the percentage of the FIFO that is full using the user-specified precision. This optional port is turned on by default for backward compatibility reasons.
- **Provide almost empty port:** Add almost empty (ae) port to the block.
- **Provide almost full port:** Add almost efull (af) port to the block.

Other parameters used by this block are explained in the topic [Common Options in Block Parameter Dialog Boxes](#).

## LogiCORE™ Documentation

[LogiCORE IP FIFO Generator 9.2](#)

[LogiCORE IP Floating-Point Operator v6.1](#)

## Device Support

Zynq-7000, Artix-7, Virtex-7, Kintex-7, Virtex-6, Virtex-5, Virtex-4, Spartan-6, Spartan-3A/3AN/3A DSP, Spartan-3E, Spartan-3

Floating-Point support is restricted to the following devices:

Zynq-7000, Artix-7, Virtex-7, Kintex-7, Virtex-6, Spartan-6,

## FIR Compiler 5.0

This block is listed in the following Xilinx Blockset libraries: *DSP and Index*

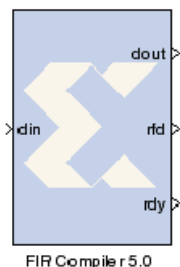

The Xilinx FIR Compiler 5.0 block implements a Multiply Accumulate-based or Distributed-Arithmetic FIR filter. It accepts a stream of input data and computes filtered output with a fixed delay, based on the filter configuration. The MAC-based filter is implemented using cascaded Xtreme DSP slices when available as shown in the figure below.

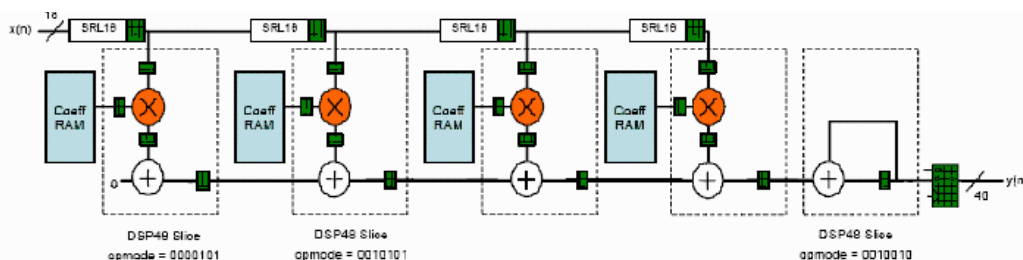

**Note:** In rest of this topic, DSP48/DSP48E/DSP48A is referred to as Xtreme DSP slice.

### Block Interface

The FIR Compiler 5.0 block can be configured to have a number of optional ports in addition to the **din** and **dout** ports which appear in all filter configurations.

#### Input Ports

- **din**: data in port on the FIR Compiler. As shown below, the data for all channels is provided to the FIR Compiler in a time multiplexed manner through this port.

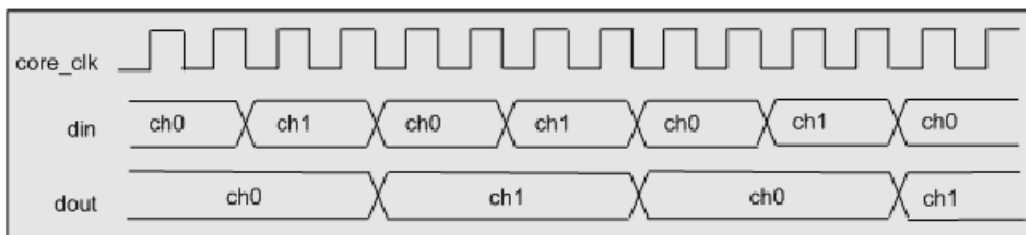

- **rst**: synchronous reset port .
- **en**: synchronous enable port.
- **nd**: This port appears on the block only when the Hardware Oversampling Specification format is specified as "Sample Period". When this signal is asserted, the data sample presented on the **din** port is accepted into the filter core. **nd** should not be asserted while **rfd** is Low; any samples presented when **rfd** is Low are ignored by the core.
- **filt\_sel**: Filter Selection input signal, F-bit wide where  $F = \text{ceil}(\log_2(\text{filter sets}))$ . Only present when using multiple filter sets.
- **coef\_ld**: Indicates the beginning of a new coefficient reload cycle.

- **coef\_we**: Used for loading the coefficients into the filter to allow a host to halt loading until ready to transmit on the interface.
- **coef\_din**: Input data bus for reloading coefficients. K is the core coefficient width for most filter types and coefficient width + 2 for interpolating filters where the symmetric coefficient structure is exploited.
- **coef\_filt\_sel**: Filter Selection input signal for reloading coefficients, F-bit wide where  $F = \text{ceil}(\log_2(\text{filter sets}))$ . Only present when using multiple filter sets and reloadable coefficients.

## Output Ports

- **dout**: Note that for multi-channel implementations, this output is time-shared across all channels.
- **rdy**: Indicates that a new filter output sample is available on the **dout** port.
- **rfd**: Indicator to signal that the core is ready to accept a new data sample.
- **chan\_in**: indicates which channel the current input is destined for in multi-channel implementations.

**Note:** When the FIR Compiler din port is sampled at a rate different than the Simulink System Period, the chan\_in input port is registered to ensure that the System Generator simulations are bit and cycle accurate. This results in the chan\_in output lagging behind the channel data on din port by 1 cycle. For example when chan\_in output says a value of 1, data sampled on din corresponds to channel 2. This behavior can be corrected by going to the Chan In options area on the Detailed Implementation tab and selecting “Generate chan\_in value in advance” and then setting “Number of samples” to 1.

- **chan\_out**: Standard binary count generated by the core that indicates the current filter output channel number.
- **dout\_i**: In-phase (I) data output component when using Hilbert transform.
- **dout\_q**: Quadrature (Q) data output component when using Hilbert transform.
- **data\_valid**: Indicator signal that can be used in conjunction with or in preference to **rdy**. The signal indicates that a new filter output sample is available on the **dout** port that has been generated from a complete data vector. Available for MAC-based FIR implementations

For more details, please refer to the LogiCORE™ data sheet

## Block Parameters

The block parameters dialog box can be invoked by double-clicking the icon in your Simulink model.

### Filter Specification tab

Parameters specific to the Filter Specification tab are as follows:

#### Filter Coefficients

- **Coefficient Vector**: Specifies the coefficient vector as a single MATLAB row vector. The number of taps is inferred from the length of the MATLAB row vector. It is possible to enter these coefficients using the [FDATool](#) block as well.
- **Number of coefficients sets**: The number of sets of filter coefficients to be implemented. The value specified must divide without remainder into the number of coefficients.

#### Filter Specification

- **Filter type**:
  - ♦ **Single\_Rate**: The data rate of the input and the output are the same.

- ◆ **Interpolation:** The data rate of the output is faster than the input by a factor specified by the **Interpolation Rate value**.
- ◆ **Decimation:** The data rate of the output is slower than the input by a factor specified in the **Decimation Rate Value**.
- ◆ **Interpolated:** An interpolated FIR filter has a similar architecture to a conventional FIR filter, but with the unit delay operator replaced by k-1 units of delay. k is referred to as the zero-padding factor. The interpolated FIR should not be confused with an interpolation filter. Interpolated filters are single-rate systems employed to produce efficient realizations of narrow-band filters and, with some minor enhancements, wide-band filters can be accommodated. The data rate of the input and the output are the same.
- ◆ **Polyphase\_Filter\_Bank\_Transmitter:** Polyphase Filter Bank Transmitter structure is used in conjunction with the Xilinx FFT Core to efficiently implement a multi-channel frequency division multiplexed (FDM) digital transmitter.
- ◆ **Polyphase\_Filter\_Bank\_Receiver:** Polyphase Filter Bank Transmitter structure is used in conjunction with the Xilinx FFT Core to efficiently implement a multi-channel frequency division multiplexed (FDM) digital transmitter.
- **Rate change type:**

This field is applicable to Interpolation and Decimation filter types.

  - ◆ **Integer:** Specifies that the rate change is an integer factor.
  - ◆ **Fixed\_Fractional:** Specifies that the rate change is a fractional factor.

*Note:* Interpolation and Decimation filters that are configured in **Fixed\_Fractional** mode, do not support automatic input handshake and rate-propagation. The filter is therefore configured with **Sample\_period** set as the Hardware Oversampling mode and the input **nd** pin exposed, which specifies the input handshaking. On the output side, no rate propagation takes place; all the output pins of the FIR Compiler block are driven at the core rate, which is the system clock rate. See the Hardware Oversampling Specification section in the document [LogiCORE IP FIR Compiler v5.0](#) for details.
- **Zero pack factor:** Allows you to specify the number of 0's inserted between the coefficient specified by the coefficient vector. A zero packing factor of k inserts k-1 0s between the supplied coefficient values. This parameter is only active when the Filter type is set to Interpolated.
- **Number of channels:** The number of data channels to be processed by the FIR Compiler block. The multiple channel data is passed to the core in a time-multiplexed manner. A maximum of 64 channels is supported.

#### Hardware Oversampling Specification

- **Select format:**
  - ◆ **Maximum\_Possible:** Specifies that oversampling be automatically determined based on the **din** sample rate.
  - ◆ **Sample\_Period:** Activates the Sample period dialog box below. Enter the Sample Period specification. When this option is specified, the ND input port is placed on the block interface. If this option is not specified, the ND input port is not displayed.
  - ◆ **Hardware Oversampling Rate:** Activates the Hardware Oversampling Rate dialog box. Enter the Hardware Oversampling Rate specification below.

**Hardware Oversampling Rate:** The hardware over sampling rate determines the degree of parallelism. A rate of one produces a fully parallel filter. A rate of n (resp., n+1) for an n-bit input signal produces a fully serial implementation for a non-symmetric (resp., symmetric) impulse response. Intermediate values produce implementations with intermediate levels of parallelism.

The figure below shows the timing diagram for Polyphase\_Filter\_Bank\_Transmitter and an example calculation for the Effective input sample period.

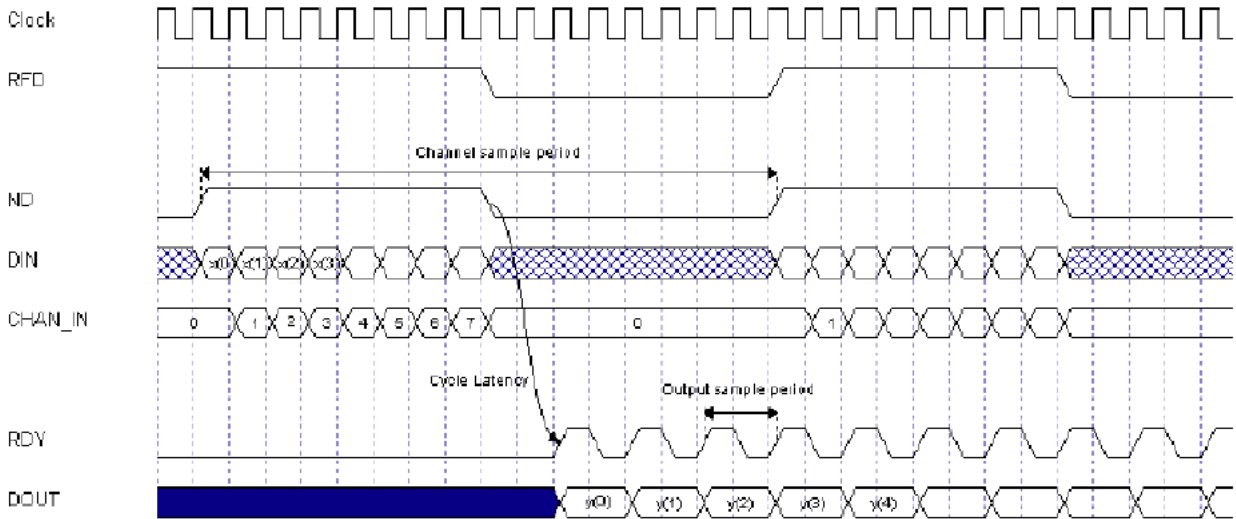

In the example shown above, there are 8 channels with a channel sample period of 16; this gives an effective input sample period of 2. The effective input sample period and output sample period will have the same value for the Polyphase Filter Bank Transmitter filter type.

The figure below demonstrates the input timing for a 3-Channel filter with the New Data port selected. In this example there is a channel sample period of 9 giving an effective sample period of 3. The input sample period, system clock period, interpolation and decimation rate determine the number of available clock cycles for data sample processing, which directly affects the level of parallelism in the core implementation.

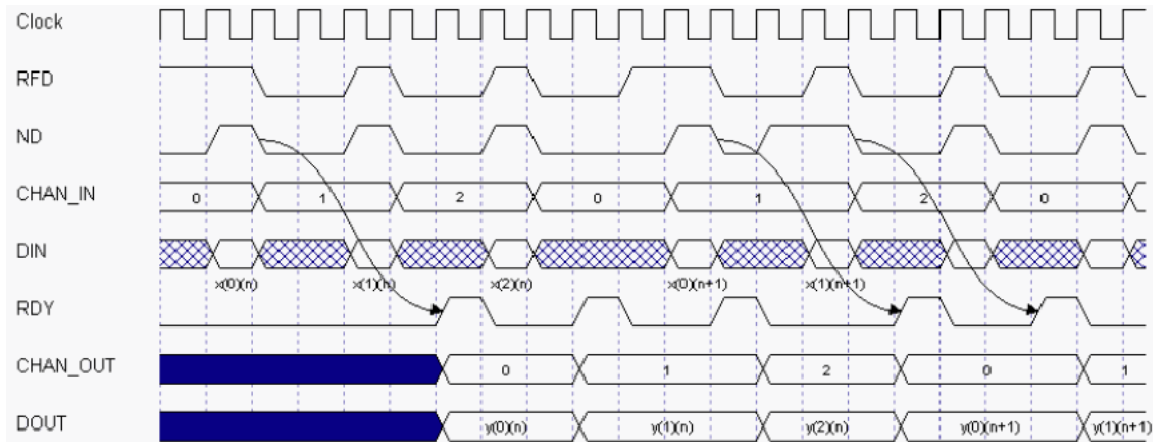

**Output Rate for Sample\_Period mode** For Sample\_Period mode, no input handshake abstraction and no rate-propagation takes place. All output pins of the FIR Compiler block are driven at the core rate, which is the system clock rate. On the System Generator token under the General tab, if you select **Normalized sample periods** as the Block icon display option, all the output pins on the FIR Compiler block will display the rate as “1”. If you select **Sample frequencies (MHz)**, then all the output pins on the FIR Compiler block will display the effective core-rate, which is the system clock-rate.

As an example, assume the following:

- Under the System Generator token Clocking tab:
  - ◆ The **FPGA clock period (ns)** is specified as 2 (i.e. 500 MHz)
  - ◆ The **Simulink system period (sec)** is specified as 1
- The Gateway In block specifies the **Sample period** as 2
- The FIR Compiler block specifies Hardware Oversampling format as **Sample\_Period**

The output pins of the FIR Compiler block will display 1 as the normalized sample period and 500 MHz (the core rate, as well as the system clock rate) as sample frequency.

## Implementation tab

Parameters specific to the Implementation tab are as follows:

- **Filter architecture** Choose one of the following:
  - ◆ **Systolic\_Multiply\_Accumulate**: This is a MAC-based architecture based on cascades of multiplier/Xtreme DSP slices.
  - ◆ **Transpose\_Multiply\_Accumulate**: The Transpose Multiply-Accumulate architecture implements a Transposed Direct-Form filter.
  - ◆ **Distributed\_Arithmetic**: Distributed Arithmetic FIR.

### Coefficient Options

- **Use reloadable coefficients**: Check to add the coefficient reload ports to the block.

*Note:* This block supports the `xlGetReloadOrder` function. See [xlGetReloadOrder](#) for details.

- **Coefficients Structure**: Specifies the coefficient structure. Depending on the coefficient structure optimizations are made in the core to reduce the amount of hardware required to implement a particular filter configuration. The selected structure can be any of the following:
  - ◆ Inferred
  - ◆ Non-Symmetric
  - ◆ Symmetric
  - ◆ Negative\_Symmetric
  - ◆ Half\_Band
  - ◆ Hilbert

The vector of coefficients specified must match the structure specified unless **Inferred** from coefficients is selected in which case the structure is determined automatically from these coefficients.

- **Coefficient type**: Specify Signed or Unsigned.
- **Quantization**: Specifies the quantization method to be used for quantizing the coefficients. This can be set to one of the following:
  - ◆ Integer\_Coefficients
  - ◆ Quantize\_Only
  - ◆ Maximize\_Dynamic\_Range
- **Coefficient width**: Specifies the number of bits used to represent the coefficients.
- **Best Precision Fractional Bits**:
- **Coefficient fractional bits**: Specifies the binary point location in the coefficients datapath options



- **Number of paths:** Specifies the number of parallel data paths the filter is to process
- **Output rounding mode:** Choose one of the following:
  - ◆ Full\_Precision
  - ◆ Truncate\_LSBs
  - ◆ Non\_Symmetric\_Rounding\_Down
  - ◆ Non\_Symmetric\_Rounding\_Up
  - ◆ Symmetric\_Rounding\_to\_Zero
  - ◆ Symmetric\_Rounding\_to\_Infinity
  - ◆ Convergent\_Rounding\_to\_Even
  - ◆ Convergent\_Rounding\_to\_Odd
- **Output width:** Specify the output width. Edit box activated only if the Rounding mode is set to a value other than **Full\_Precision**.
- **Allow rounding approximation:** Check to specify that approximations can be used to save resources when using Symmetric\_Rounding.

### Detailed Implementation tab

Parameters specific to the Detailed Implementaton tab are as follows:

- **Optimization goal:** Specifies if the core is required to operate at maximum possible speed (“Speed” option) or minimum area (“Area” option). The “Area” option is the recommended default and will normally achieve the best speed and area for the design, however in certain configurations, the “Speed” setting might be required to improve performance at the expense of overall resource usage (this setting normally adds pipeline registers in critical paths)
  - ◆ **Area**
  - ◆ **Speed**

#### Control Options

- **rst:** Provides a **rst** port on the block. This core always uses the sclr\_deterministic option when using **rst**. Please refer to the LogiCORE™ data sheet for more information on the sclr\_deterministion option.
- **data\_valid:** Has a data valid output port.
- **nd:** Has a nd (new data) input port.
- **ce:** Provides a clock enable port on the block.

#### Chan In options

- **Generate chan\_in value in advance:** Specifies that the filter will generate the CHAN\_IN value a number of input samples in advance.
- **Number of samples:** Specifies the number of inputs sample in advance that the CHAN\_IN value is generated.

#### Memory Options

The memory type for MAC implementations can either be user-selected or chosen automatically to suit the best implementation options. Note that a choice of “Distributed” might result in a shift register implementation where appropriate to the filter structure. Forcing the RAM selection to be either Block or Distributed should be used with caution, as inappropriate use can lead to inefficient resource usage - the default Automatic mode is recommended for most applications.

- **Data buffer type:** Specifies the type of memory used to store data samples.

- **Coefficient buffer type:** Specifies the type of memory used to store the coefficients.
- **Input buffer type:** Specifies the type of memory to be used to implement the data input buffer, where present.
- **Output buffer type:** Specifies the type of memory to be used to implement the data output buffer, where present.
- **Preference for other storage:** Specifies the type of memory to be used to implement general storage in the datapath.

#### DSP Slice Column options

- **Multi column support:** For device families with DSP slices, implementations of large high speed filters might require chaining of DSP slice elements across multiple columns. Where applicable (the feature is only enabled for multi-column devices), you can select the method of folding the filter structure across the multiple-columns, which can be **Automatic** (based on the selected device for the project) or **Custom** (you select the length of the first and subsequent columns).
- **Column Configuration:** Specifies the individual column lengths in a comma delimited list. (See the data sheet for a more detailed explanation.)
- **Inter-Column Pipe Length:** Pipeline stages are required to connect between the columns, with the level of pipelining required being depending on the required system clock rate, the chosen device and other system-level parameters. The choice of this parameter is always left for you to specify.

Other parameters used by this block are explained in the topic [Common Options in Block Parameter Dialog Boxes](#).

## LogiCORE™ Documentation

[LogiCORE IP FIR Compiler v5.0](#)

## Device Support

Virtex-7 and Kintex-7, Virtex-6, Virtex-5, Virtex-4,  
Spartan-6, Spartan-3/XA, Spartan-3E/XA, Spartan-3A/3AN/3A DSP/XA

## FIR Compiler 6.2

This block is listed in the following Xilinx Blockset libraries: AXI4, DSP and Index

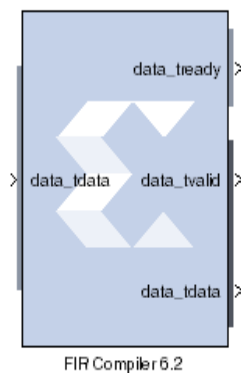

The Xilinx FIR Compiler 6.2 block provides users with a way to generate highly parameterizable, area-efficient, high-performance FIR filters with an AXI4-Stream-compliant interface.

Refer to the topic [AXI Interface](#) for more detailed information on the AXI Interface.

### AXI Ports that are Unique to this Block

This Sysgen Generator block exposes the AXI CONFIG channel as a group of separate ports based on sub-field names. The sub-field ports are described as follows:

Configuration Channel Input Signals:

<code>config_tdata_fsel</code>	A sub-field port that represents the <b>fsel</b> field in the Configuration Channel vector. <b>fsel</b> is used to select the active filter set. This port is exposed when the number of coefficient sets is greater than one. Refer to the FIR Compiler V6.2 Product Specification starting on page 5 for an explanation of the bits in this field.
--------------------------------	--

### Block Parameters

The block parameters dialog box can be invoked by double-clicking the icon in your Simulink model.

#### Filter Specification tab

Parameters specific to the Filter Specification tab are as follows:

Filter Coefficients

- **Coefficient Vector:** Specifies the coefficient vector as a single MATLAB row vector. The number of taps is inferred from the length of the MATLAB row vector. If multiple coefficient sets are specified, then each set is appended to the previous set in the vector. It is possible to enter these coefficients using the [FDATool](#) block as well.
- **Number of Coefficients Sets:** The number of sets of filter coefficients to be implemented. The value specified must divide without remainder into the number of coefficients.

Filter Specification

- **Filter Type:**
  - ◆ **Single\_Rate:** The data rate of the input and the output are the same.
  - ◆ **Interpolation:** The data rate of the output is faster than the input by a factor specified by the Interpolation Rate value.
  - ◆ **Decimation:** The data rate of the output is slower than the input by a factor specified in the Decimation Rate Value.

- **Rate Change Type:** This field is applicable to Interpolation and Decimation filter types. Used to specify an **Integer** or **Fixed\_Fractional** rate change.  
*Note:* Interpolation and Decimation filters that are configured in **Fixed\_Fractional** mode, do not support automatic input handshake and rate-propagation. The filter is therefore configured with **Sample\_period** set as the Hardware Oversampling mode and the *s\_axis\_data\_tvalid* input exposed, which specifies the input handshaking. On the output side, no rate propagation takes place; all the output pins of the FIR Compiler block are driven at the core rate, which is the system clock rate. See the Hardware Oversampling Specification section in the document [LogiCORE IP FIR Compiler v6.2 Product Specification](#) for details.
- **Interpolation Rate Value:** This field is applicable to all Interpolation filter types and Decimation filter types for Fractional Rate Change implementations. The value provided in this field defines the up-sampling factor, or P for Fixed Fractional Rate (P/Q) resampling filter implementations.
- **Decimation Rate Value:** This field is applicable to the all Decimation and Interpolation filter types for Fractional Rate Change implementations. The value provided in this field defines the down-sampling factor, or Q for Fixed Fractional Rate (P/Q) resampling filter implementations.
- **Number of Channels:** The number of data channels to be processed by the FIR Compiler block. The multiple channel data is passed to the core in a time-multiplexed manner. A maximum of 64 channels is supported.

#### Hardware Oversampling Specification

- **Select format:**
  - ◆ **Maximum\_Possible:** Specifies that oversampling be automatically determined based on the din sample rate.
  - ◆ **Sample\_Period:** Activates the Sample period dialog box below. Enter the Sample Period specification. Selecting this option exposes the *s\_axis\_data\_tvalid* port (called ND port on earlier versions of the core). With this port exposed, no input handshake abstraction and no rate-propagation takes place.
  - ◆ **Hardware Oversampling Rate:** Activates the Hardware Oversampling Rate dialog box. Enter the Hardware Oversampling Rate specification below.

**Hardware Oversampling Rate:** The hardware over sampling rate determines the degree of parallelism. A rate of one produces a fully parallel filter. A rate of  $n$  (resp.,  $n+1$ ) for an  $n$ -bit input signal produces a fully serial implementation for a non-symmetric (resp., symmetric) impulse response. Intermediate values produce implementations with intermediate levels of parallelism.

**Output Rate for Sample\_Period mode** For Sample\_Period mode, no input handshake abstraction and no rate-propagation takes place. All output pins of the FIR Compiler block are driven at the core rate, which is the system clock rate. On the System Generator token under the General tab, if you select **Normalized sample periods** as the Block icon display option, all the output pins on the FIR Compiler block will display the rate as “1”. If you select **Sample frequencies (MHz)**, then all the output pins on the FIR Compiler block will display the effective core-rate, which is the system clock-rate.

As an example, assume the following:

- Under the System Generator token Clocking tab:
  - ◆ The **FPGA clock period (ns)** is specified as 2 (i.e. 500 MHz)
  - ◆ The **Simulink system period (sec)** is specified as 1
- The Gateway In block specifies the **Sample period** as 2
- The FIR Compiler block specifies Hardware Oversampling format as **Sample\_Period**

The output pins of the FIR Compiler block will display 1 as the normalized sample period and 500 MHz (the core rate, as well as the system clock rate) as sample frequency.

## Implementation tab

Parameters specific to the Implementation tab are as follows:

- **Filter Architecture:** Choose **Systolic\_Multiply\_Accumulate** or **Transpose\_Multiply\_Accumulate**. The differences in these architectures are fully explained in the associated FIR Compiler V6.2 Product Specification.

Coefficient Options

- **Use Reloadable Coefficients:** Check to add the coefficient reload ports to the block.  
*Note:* The set of data loaded into the RELOAD channel will not take action until triggered by a re-configuration synchronization event. Refer to the [LogiCORE IP FIR Compiler v6.2 Product Specification](#) starting on page 25 for a more detailed explanation of the RELOAD Channel interface timing. This block supports the `xlGetReloadOrder` function. See [xlGetReloadOrder](#) for details.
- **Coefficient Type:** Specify Signed or Unsigned.
- **Quantization:** Specifies the quantization method to be used for quantizing the coefficients. This can be set to one of the following:
  - ◆ Integer\_Coefficients
  - ◆ Quantize\_Only
  - ◆ Maximize\_Dynamic\_Range
- **Coefficient Width:** Specifies the number of bits used to represent the coefficients.
- **Best Precision Fractional Bits:** When selected, the coefficient fractional width is automatically set to maximize the precision of the specified filter coefficients.
- **Coefficient Fractional Bits:** Specifies the binary point location in the coefficients datapath options
- **Coefficients Structure:** Specifies the coefficient structure. Depending on the coefficient structure optimizations are made in the core to reduce the amount of hardware required to implement a particular filter configuration. The selected structure can be any of the following:
  - ◆ Inferred
  - ◆ Non-Symmetric
  - ◆ Symmetric
  - ◆ Negative\_Symmetric
  - ◆ Half\_Band

The vector of coefficients specified must match the structure specified unless Inferred from coefficients is selected in which case the structure is determined automatically from these coefficients.

**Datapath Options**

- **Number of Paths:** Specifies the number of parallel data paths the filter is to process. As shown below, when more than one path is specified, the data\_tdata input port is divided into sub-ports that represent each parallel path:

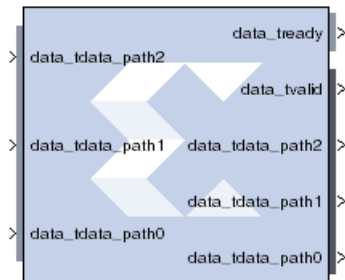

- **Output Rounding Mode:** Choose one of the following:
  - ◆ Full\_Precision
  - ◆ Truncate\_LSBs
  - ◆ Non\_Symmetric\_Rounding\_Down
  - ◆ Non\_Symmetric\_Rounding\_Up
  - ◆ Symmetric\_Rounding\_to\_Zero
  - ◆ Symmetric\_Rounding\_to\_Infinity
  - ◆ Convergent\_Rounding\_to\_Even
  - ◆ Convergent\_Rounding\_to\_Odd
- **Output Width:** Specify the output width. Edit box activated only if the Rounding mode is set to a value other than Full\_Precision.

## Detailed Implementation tab

Parameters specific to the Detailed Implementation tab are as follows:

- **Optimization goal:** Specifies if the core is required to operate at maximum possible speed (“Speed” option) or minimum area (“Area” option). The “Area” option is the recommended default and will normally achieve the best speed and area for the design, however in certain configurations, the “Speed” setting might be required to improve performance at the expense of overall resource usage (this setting normally adds pipeline registers in critical paths)
  - ◆ Area
  - ◆ Speed

Data Channel Options

- **TLAST:** TLAST can either be Not\_Required, in which case the block will not have the port, or Vector\_Framing, where TLAST is expected to denote the last sample of an interleaved cycle of data channels, or Packet\_Framing, where the block does not interpret TLAST, but passes the signal to the output DATA channel TLAST with the same latency as the datapath.
- **Output TREADY:** This field enables the data\_tready port. With this port enabled, the block will support back-pressure. Without the port, back-pressure is not supported, but resources are saved and performance is likely to be higher.
- **TUSER:** Select one of the following options for the Input and the Output.
  - ◆ **Not\_Required:** Neither of the uses is required; the channel in question will not have a TUSER field.

- ◆ **User\_Field:** In this mode, the block ignores the content of the TUSER field, but passes the content untouched from the input channel to the output channels.
- ◆ **Chan\_ID\_Field:** In this mode, the TUSER field identifies the time-division-multiplexed channel for the transfer.
- ◆ **User and Chan\_ID\_Field:** In this mode, the TUSER field will have both a user field and a chan\_id field, with the chan\_id field in the least significant bits. The minimal number of bits required to describe the channel will determine the width of the chan\_id field, e.g. 7 channels will require 3 bits.

#### Configuration Channel Options

- **Synchronization Mode:**
  - ◆ **On\_Vector:** Configuration packets, when available, are consumed and their contents applied when the first sample of an interleaved data channel sequence is processed by the block. When the block is configured to process a single data channel configuration packets are consumed every processing cycle of the block.
  - ◆ **On\_Packet:** Further qualifies the consumption of configuration packets. Packets will only be consumed once the block has received a transaction on the s\_axis\_data channel where s\_axis\_data\_tlast has been asserted.
- **Configuration Method:**
  - ◆ **Single:** A single coefficient set is used to process all interleaved data channels.
  - ◆ **By\_Channel:** A unique coefficient set is specified for each interleaved data channel.

#### Reload Channel Options

- ◆ **Num reload slots:** Specifies the number of coefficient sets that can be loaded in advance. Reloaded coefficients are only applied to the block once the configuration packet has been consumed. (Range 1 to 256).

#### Control Options

- **ACLKEN:** Active-high clock enable. Available for MAC-based FIR implementations.
- **ARESETn:** Active-low synchronous clear input that always takes priority over ACLKEN. A minimum ARESETn active pulse of two cycles is required, since the signal is internally registered for performance. A pulse of one cycle resets the control and datapath of the core, but the response to the pulse is not in the cycle immediately following.

#### DSP Slice Column Options

- **Multi-Column Support:** For device families with DSP slices, implementations of large high speed filters might require chaining of DSP slice elements across multiple columns. Where applicable (the feature is only enabled for multi-column devices), you can select the method of folding the filter structure across the multiple-columns, which can be Automatic (based on the selected device for the project) or Custom (you select the length of the first and subsequent columns).
- **Column Configuration:** Specifies the individual column lengths in a comma delimited list. (See the data sheet for a more detailed explanation.)
- **Inter-Column Pipe Length:** Pipeline stages are required to connect between the columns, with the level of pipelining required being depending on the required system clock rate, the chosen device and other system-level parameters. The choice of this parameter is always left for you to specify.

## Memory Options tab

The memory type for MAC implementations can either be user-selected or chosen automatically to suit the best implementation options. Note that a choice of “Distributed” might result in a shift register implementation where appropriate to the filter structure. Forcing the RAM selection to be either Block or Distributed should be used with caution, as inappropriate use can lead to inefficient resource usage - the default Automatic mode is recommended for most applications.

- **Data Buffer Type:** Specifies the type of memory used to store data samples.
- **Coefficient Buffer Type:** Specifies the type of memory used to store the coefficients.
- **Input Buffer Type:** Specifies the type of memory to be used to implement the data input buffer, where present.
- **Output Buffer type:** Specifies the type of memory to be used to implement the data output buffer, where present.

**Preference for other storage:** Specifies the type of memory to be used to implement general storage in the datapath.

## Advanced tab

Block Icon Display

**Display shortened port names:** On by default. When unchecked, data\_tvalid, for example, becomes m\_axis\_data\_tvalid.

Other parameters used by this block are explained in the topic [Common Options in Block Parameter Dialog Boxes](#).

## How to Migrate from FIR Compiler 5.0 to FIR Compiler 6.2

### Design description

This example shows how to migrate from the non-AXI4 FIR Compiler block to AXI4 FIR Compiler block using the same or similar block parameters. Some of the parameters between non-AXI4 and AXI4 versions might not be identical exactly due to some changes in certain features and block interfaces. The following model is used to illustrate the design migration between these block. For more detail, refer to the datasheet of this IP core.



Both FIR Compiler blocks are configured as a reloadable coefficient FIR filter. The first set of the coefficients was specified and loaded by the core and the second set was loaded from an external source.

Example showing how to migrate to AXI4 FIR Compiler IP block

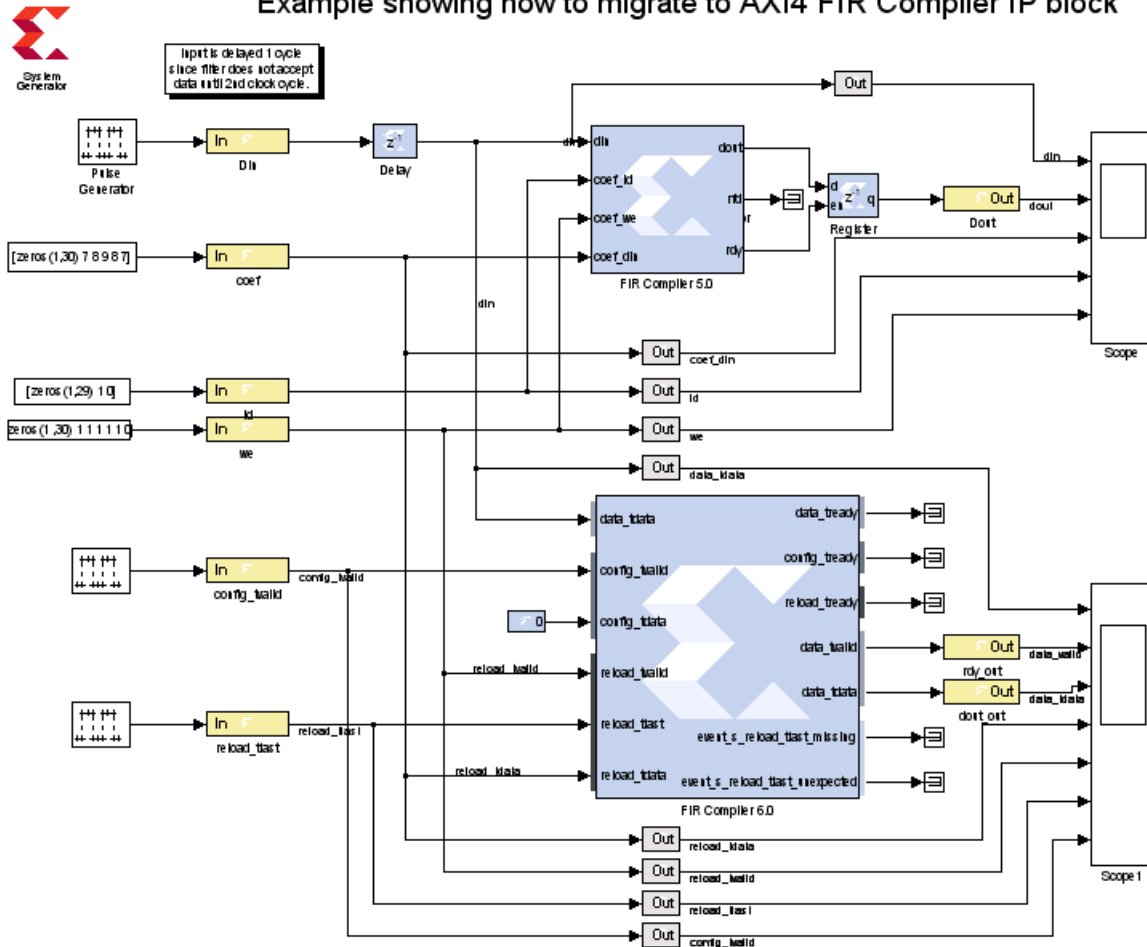

The figure below shows output simulation from the non-AXI, reloadable FIR Compiler block.

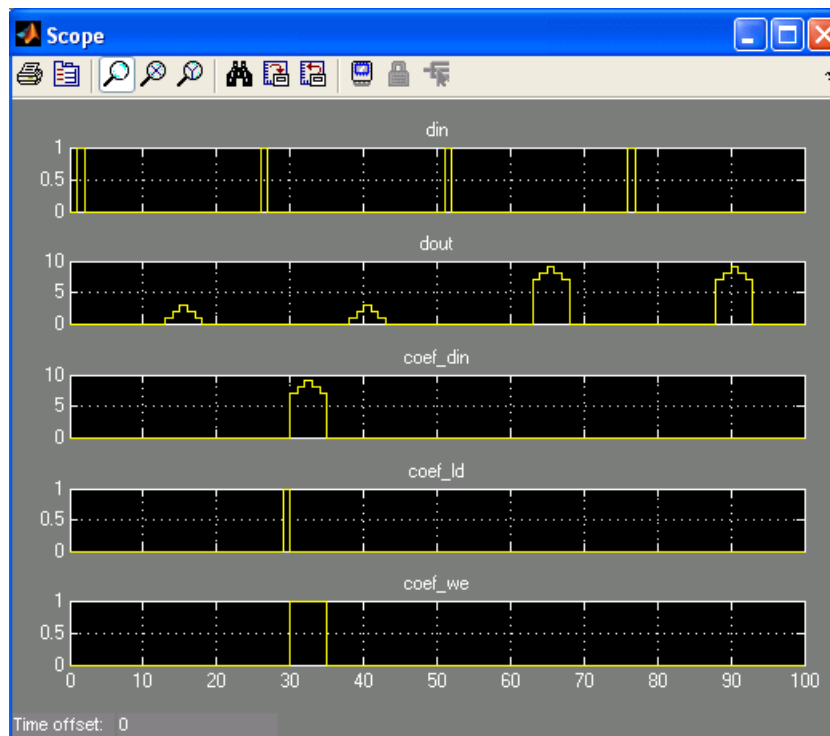

### Data Path and Control Signals:

As shown in the figure below, the sequence of events to reload new filter coefficients are quite different between the non-AXI and AXI4 versions as briefly described next. Care must be taken to ensure that the following loading sequences are taken place.

1. data\_tdata: AXI FIR output data based on the initial set of coefficients specified by the core ([1,2,3,2,1])
2. reload\_tdata and reload\_tvalid: Next is to load a new set of coefficients ([7 8 9 8 7]) into the reload\_tdata input port. The reload\_tvalid control signal must be high during this reload period. In this case, it must be high for 5 clock cycles.
3. reload\_tlast: this signal must be high on the last coefficient data to indicate that the last data has been loaded
4. config\_tvalid: finally, the reload data is now available for transfer. This control signal does not have to strobe high immediately after the reload\_tlast assertion

The figure below shows output simulation from the AXI4, reloadable FIR Compiler block.

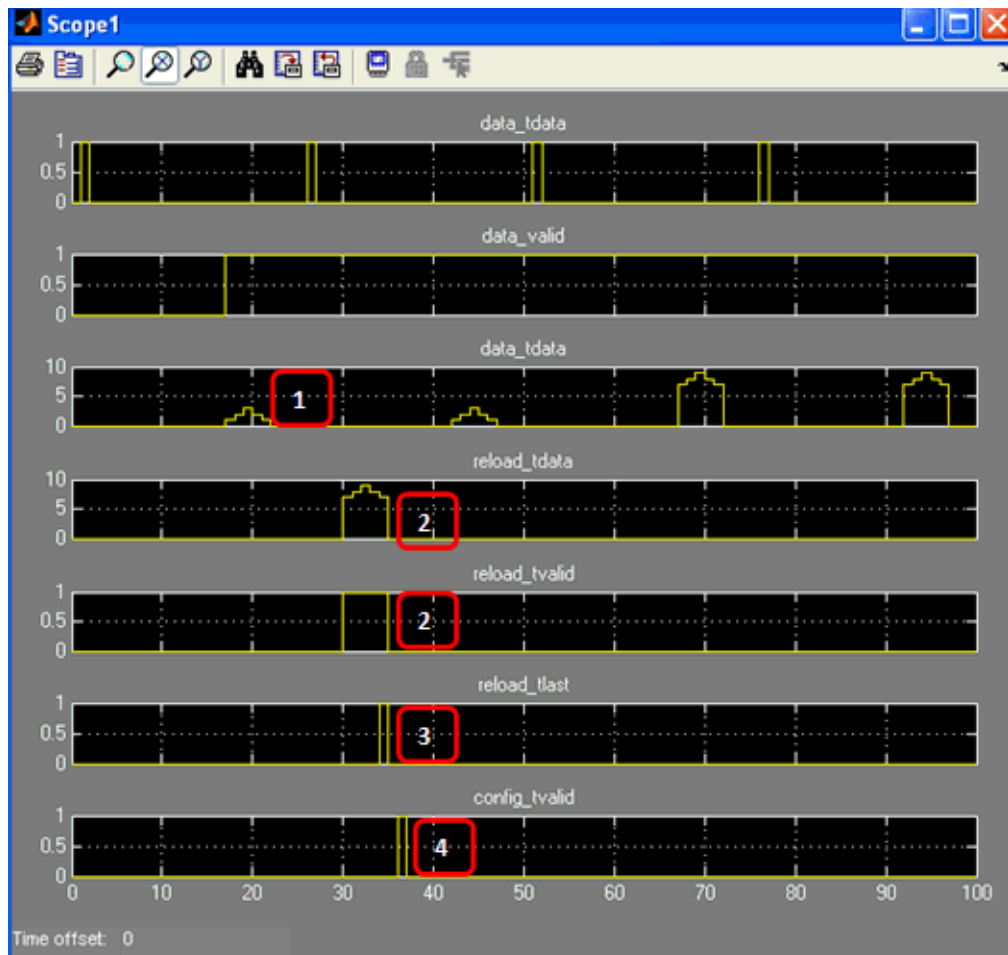

## LogiCORE™ Documentation

[LogiCORE IP FIR Compiler v6.2](#)

## Device Support

Kintex-7, Virtex-7, Artix-7, Zynq-7000, Virtex-6, Spartan-6

## FIR Compiler 6.3

This block is listed in the following Xilinx Blockset libraries: AXI4, DSP and Index

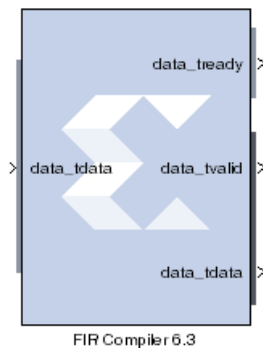

The Xilinx FIR Compiler 6.3 block provides users with a way to generate highly parameterizable, area-efficient, high-performance FIR filters with an AXI4-Stream-compliant interface.

Refer to the topic [AXI Interface](#) for more detailed information on the AXI Interface.

### AXI Ports that are Unique to this Block

This Sysgen Generator block exposes the AXI CONFIG channel as a group of separate ports based on sub-field names. The sub-field ports are described as follows:

Configuration Channel Input Signals:

`config_tdata_fsel`

A sub-field port that represents the **fsel** field in the Configuration Channel vector. **fsel** is used to select the active filter set. This port is exposed when the number of coefficient sets is greater than one. Refer to the [LogiCORE IP FIR Compiler v6.3 Product Specification](#) starting on page 5 for an explanation of the bits in this field.

### Block Parameters

The block parameters dialog box can be invoked by double-clicking the icon in your Simulink model.

#### Filter Specification tab

Parameters specific to the Filter Specification tab are as follows:

Filter Coefficients

- **Coefficient Vector:** Specifies the coefficient vector as a single MATLAB row vector. The number of taps is inferred from the length of the MATLAB row vector. If multiple coefficient sets are specified, then each set is appended to the previous set in the vector. It is possible to enter these coefficients using the [FDATool](#) block as well.
- **Number of Coefficients Sets:** The number of sets of filter coefficients to be implemented. The value specified must divide without remainder into the number of coefficients.
- **Use Reloadable Coefficients:** Check to add the coefficient reload ports to the block. The set of data loaded into the reload channel will not take action until triggered by a re-configuration synchronization event. Refer to the [LogiCORE IP FIR Compiler v6.3 Product Specification](#) starting on page 25 for a more detailed explanation of the RELOAD Channel interface timing. This block supports the `xlGetReloadOrder` function. See [xlGetReloadOrder](#) for details.

## Filter Specification

- **Filter Type:**
  - ◆ **Single\_Rate:** The data rate of the input and the output are the same.
  - ◆ **Interpolation:** The data rate of the output is faster than the input by a factor specified by the Interpolation Rate value.
  - ◆ **Decimation:** The data rate of the output is slower than the input by a factor specified in the Decimation Rate Value.
  - ◆ **Hilbert:** Filter uses the Hilbert Transform.
  - ◆ **Interpolated:** An interpolated FIR filter has a similar architecture to a conventional FIR filter, but with the unit delay operator replaced by k-1 units of delay. k is referred to as the zero-packing factor. The interpolated FIR should not be confused with an interpolation filter. Interpolated filters are single-rate systems employed to produce efficient realizations of narrow-band filters and, with some minor enhancements, wide-band filters can be accommodated. The data rate of the input and the output are the same.
- **Rate Change Type:** This field is applicable to Interpolation and Decimation filter types. Used to specify an **Integer** or **Fixed\_Fractional** rate change.
 

*Note:* Interpolation and Decimation filters that are configured in **Fixed\_Fractional** mode, do not support automatic input handshake and rate-propagation. The filter is therefore configured with **Sample\_period** set as the Hardware Oversampling mode and the *s\_axis\_data\_tvalid* input exposed, which specifies the input handshaking. On the output side, no rate propagation takes place; all the output pins of the FIR Compiler block are driven at the core rate, which is the system clock rate. See the Hardware Oversampling Specification section in the document [LogiCORE IP FIR Compiler v6.3](#) for details.
- **Interpolation Rate Value:** This field is applicable to all Interpolation filter types and Decimation filter types for Fractional Rate Change implementations. The value provided in this field defines the up-sampling factor, or P for Fixed Fractional Rate (P/Q) resampling filter implementations.
- **Decimation Rate Value:** This field is applicable to the all Decimation and Interpolation filter types for Fractional Rate Change implementations. The value provided in this field defines the down-sampling factor, or Q for Fixed Fractional Rate (P/Q) resampling filter implementations.
- **Zero pack factor:** Allows you to specify the number of 0's inserted between the coefficient specified by the coefficient vector. A zero packing factor of k inserts k-1 0s between the supplied coefficient values. This parameter is only active when the Filter type is set to Interpolated.

## Channel Specification tab

Parameters specific to the Channel Specification tab are as follows:

## Interleaved Channel Specification

- **Channel Sequence:** Select Basic or Advanced. See the LogiCORE IP FIR Compiler v6.3 Product Specification for an explanation of the advanced channel specification feature.
- **Number of Channels:** The number of data channels to be processed by the FIR Compiler block. The multiple channel data is passed to the core in a time-multiplexed manner. A maximum of 64 channels is supported.
- **Sequence ID List:** A comma delimited list that specifies which channel sequences are implemented.

## Parallel Channel Specification

- **Number of Paths:** Specifies the number of parallel data paths the filter is to process. As shown below, when more than one path is specified, the data\_tdata input port is divided into sub-ports that represent each parallel path:

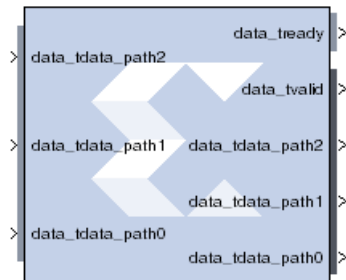

#### Hardware Oversampling Specification

- **Select format:**
  - ◆ **Maximum\_Possible:** Specifies that oversampling be automatically determined based on the din sample rate.
  - ◆ **Sample\_Period:** Activates the Sample period dialog box below. Enter the Sample Period specification. Selecting this option exposes the s\_axis\_data\_tvalid port (called nd port on earlier versions of the core). With this port exposed, no input handshake abstraction and no rate-propagation takes place.
  - ◆ **Hardware Oversampling Rate:** Activates the Hardware Oversampling Rate dialog box. Enter the Hardware Oversampling Rate specification below.

**Hardware Oversampling Rate:** The hardware over sampling rate determines the degree of parallelism. A rate of one produces a fully parallel filter. A rate of  $n$  (resp.,  $n+1$ ) for an  $n$ -bit input signal produces a fully serial implementation for a non-symmetric (resp., symmetric) impulse response. Intermediate values produce implementations with intermediate levels of parallelism.

**Output Rate for Sample\_Period mode** For Sample\_Period mode, no input handshake abstraction and no rate-propagation takes place. All output pins of the FIR Compiler block are driven at the core rate, which is the system clock rate. On the System Generator token under the General tab, if you select **Normalized sample periods** as the Block icon display option, all the output pins on the FIR Compiler block will display the rate as “1”. If you select **Sample frequencies (MHz)**, then all the output pins on the FIR Compiler block will display the effective core-rate, which is the system clock-rate.

As an example, assume the following:

- Under the System Generator token Clocking tab:
  - ◆ The **FPGA clock period (ns)** is specified as 2 (i.e. 500 MHz)
  - ◆ The **Simulink system period (sec)** is specified as 1
- The Gateway In block specifies the **Sample period** as 2
- The FIR Compiler block specifies Hardware Oversampling format as **Sample\_Period**

The output pins of the FIR Compiler block will display 1 as the normalized sample period and 500 MHz (the core rate, as well as the system clock rate) as sample frequency.

## Implementation tab

Parameters specific to the Implementation tab are as follows:

- **Filter Architecture:** Choose **Systolic\_Multiply\_Accumulate** or **Transpose\_Multiply\_Accumulate**. The differences in these architectures are fully explained in the associated FIR Compiler V6.3 Product Specification.

### Coefficient Options

- **Coefficient Type:** Specify Signed or Unsigned.
- **Quantization:** Specifies the quantization method to be used for quantizing the coefficients. This can be set to one of the following:
  - ◆ Integer\_Coefficients
  - ◆ Quantize\_Only
  - ◆ Maximize\_Dynamic\_Range
- **Coefficient Width:** Specifies the number of bits used to represent the coefficients.
- **Best Precision Fractional Bits:** When selected, the coefficient fractional width is automatically set to maximize the precision of the specified filter coefficients.
- **Coefficient Fractional Bits:** Specifies the binary point location in the coefficients datapath options
- **Coefficients Structure:** Specifies the coefficient structure. Depending on the coefficient structure optimizations are made in the core to reduce the amount of hardware required to implement a particular filter configuration. The selected structure can be any of the following:
  - ◆ Inferred
  - ◆ Non-Symmetric
  - ◆ Symmetric
  - ◆ Negative\_Symmetric
  - ◆ Half\_Band
  - ◆ Hilbert

The vector of coefficients specified must match the structure specified unless Inferred from coefficients is selected in which case the structure is determined automatically from these coefficients.

### Datapath Options

- **Output Rounding Mode:** Choose one of the following:
  - ◆ Full\_Precision
  - ◆ Truncate\_LSBs
  - ◆ Non\_Symmetric\_Rounding\_Down
  - ◆ Non\_Symmetric\_Rounding\_Up
  - ◆ Symmetric\_Rounding\_to\_Zero
  - ◆ Symmetric\_Rounding\_to\_Infinity
  - ◆ Convergent\_Rounding\_to\_Even
  - ◆ Convergent\_Rounding\_to\_Odd
- **Output Width:** Specify the output width. Edit box activated only if the Rounding mode is set to a value other than Full\_Precision.

## Detailed Implementation tab

Parameters specific to the Detailed Implementation tab are as follows:

- **Filter Architecture**

The following two filter architectures are supported.

- ◆ Systolic\_Multiply\_Accumulate
- ◆ Transpose\_Multiply\_Accumulate
- **Optimization goal:** Specifies if the core is required to operate at maximum possible speed (“Speed” option) or minimum area (“Area” option). The “Area” option is the recommended default and will normally achieve the best speed and area for the design, however in certain configurations, the “Speed” setting might be required to improve performance at the expense of overall resource usage (this setting normally adds pipeline registers in critical paths)
  - ◆ Area
  - ◆ Speed
  - ◆ Speed\_(Control\_only)
  - ◆ Speed\_(Data\_only)

### Memory Options

The memory type for MAC implementations can either be user-selected or chosen automatically to suit the best implementation options. Note that a choice of “Distributed” might result in a shift register implementation where appropriate to the filter structure. Forcing the RAM selection to be either Block or Distributed should be used with caution, as inappropriate use can lead to inefficient resource usage - the default Automatic mode is recommended for most applications.

- **Data Buffer Type:** Specifies the type of memory used to store data samples.
- **Coefficient Buffer Type:** Specifies the type of memory used to store the coefficients.
- **Input Buffer Type:** Specifies the type of memory to be used to implement the data input buffer, where present.
- **Output Buffer type:** Specifies the type of memory to be used to implement the data output buffer, where present.

**Preference for other storage:** Specifies the type of memory to be used to implement general storage in the datapath.

### DSP Slice Column Options

- **Multi-Column Support:** For device families with DSP slices, implementations of large high speed filters might require chaining of DSP slice elements across multiple columns. Where applicable (the feature is only enabled for multi-column devices), you can select the method of folding the filter structure across the multiple-columns, which can be Automatic (based on the selected device for the project) or Custom (you select the length of the first and subsequent columns).
- **Column Configuration:** Specifies the individual column lengths in a comma delimited list. (See the data sheet for a more detailed explanation.)
- **Inter-Column Pipe Length:** Pipeline stages are required to connect between the columns, with the level of pipelining required being depending on the required system clock rate, the chosen device and other system-level parameters. The choice of this parameter is always left for you to specify.



## Interface tab

### Data Channel Options

- **TLAST:** TLAST can either be Not\_Required, in which case the block will not have the port, or Vector\_Framing, where TLAST is expected to denote the last sample of an interleaved cycle of data channels, or Packet\_Framing, where the block does not interpret TLAST, but passes the signal to the output DATA channel TLAST with the same latency as the datapath.
- **Output TREADY:** This field enables the data\_tready port. With this port enabled, the block will support back-pressure. Without the port, back-pressure is not supported, but resources are saved and performance is likely to be higher.
- **TUSER:** Select one of the following options for the Input and the Output.
  - ◆ **Not\_Required:** Neither of the uses is required; the channel in question will not have a TUSER field.
  - ◆ **User\_Field:** In this mode, the block ignores the content of the TUSER field, but passes the content untouched from the input channel to the output channels.
  - ◆ **Chan\_ID\_Field:** In this mode, the TUSER field identifies the time-division-multiplexed channel for the transfer.
  - ◆ **User and Chan\_ID\_Field:** In this mode, the TUSER field will have both a user field and a chan\_id field, with the chan\_id field in the least significant bits. The minimal number of bits required to describe the channel will determine the width of the chan\_id field, e.g. 7 channels will require 3 bits.

### Configuration Channel Options

- **Synchronization Mode:**
  - ◆ **On\_Vector:** Configuration packets, when available, are consumed and their contents applied when the first sample of an interleaved data channel sequence is processed by the block. When the block is configured to process a single data channel configuration packets are consumed every processing cycle of the block.
  - ◆ **On\_Packet:** Further qualifies the consumption of configuration packets. Packets will only be consumed once the block has received a transaction on the s\_axis\_data channel where s\_axis\_data\_tlast has been asserted.
- **Configuration Method:**
  - ◆ **Single:** A single coefficient set is used to process all interleaved data channels.
  - ◆ **By\_Channel:** A unique coefficient set is specified for each interleaved data channel.

### Reload Channel Options

- ◆ **Num reload slots:** Specifies the number of coefficient sets that can be loaded in advance. Reloaded coefficients are only applied to the block once the configuration packet has been consumed. (Range 1 to 256).

### Control Options

- **ACLKEN:** Active-high clock enable. Available for MAC-based FIR implementations.
- **ARESETn (active low):** Active-low synchronous clear input that always takes priority over ACLKEN. A minimum ARESETn active pulse of two cycles is required, since the signal is internally registered for performance. A pulse of one cycle resets the core, but the response to the pulse is not in the cycle immediately following.

### Advanced tab

Block Icon Display

**Display shortened port names:** On by default. When unchecked, data\_tvalid, for example, becomes m\_axis\_data\_tvalid.

Other parameters used by this block are explained in the topic [Common Options in Block Parameter Dialog Boxes](#).

### How to Migrate from FIR Compiler 5.0 to FIR Compiler 6.3

#### Design description

This example shows how to migrate from the non-AXI4 FIR Compiler block to AXI4 FIR Compiler block using the same or similar block parameters. Some of the parameters between non-AXI4 and AXI4 versions might not be identical exactly due to some changes in certain features and block interfaces. The following model is used to illustrate the design migration between these block. For more detail, refer to the datasheet of this IP core.

Both FIR Compiler blocks are configured as a reloadable coefficient FIR filter. The first set of the coefficients was specified and loaded by the core and the second set was loaded from an external source.

Example showing how to migrate to AXI4 FIR Compiler IP block

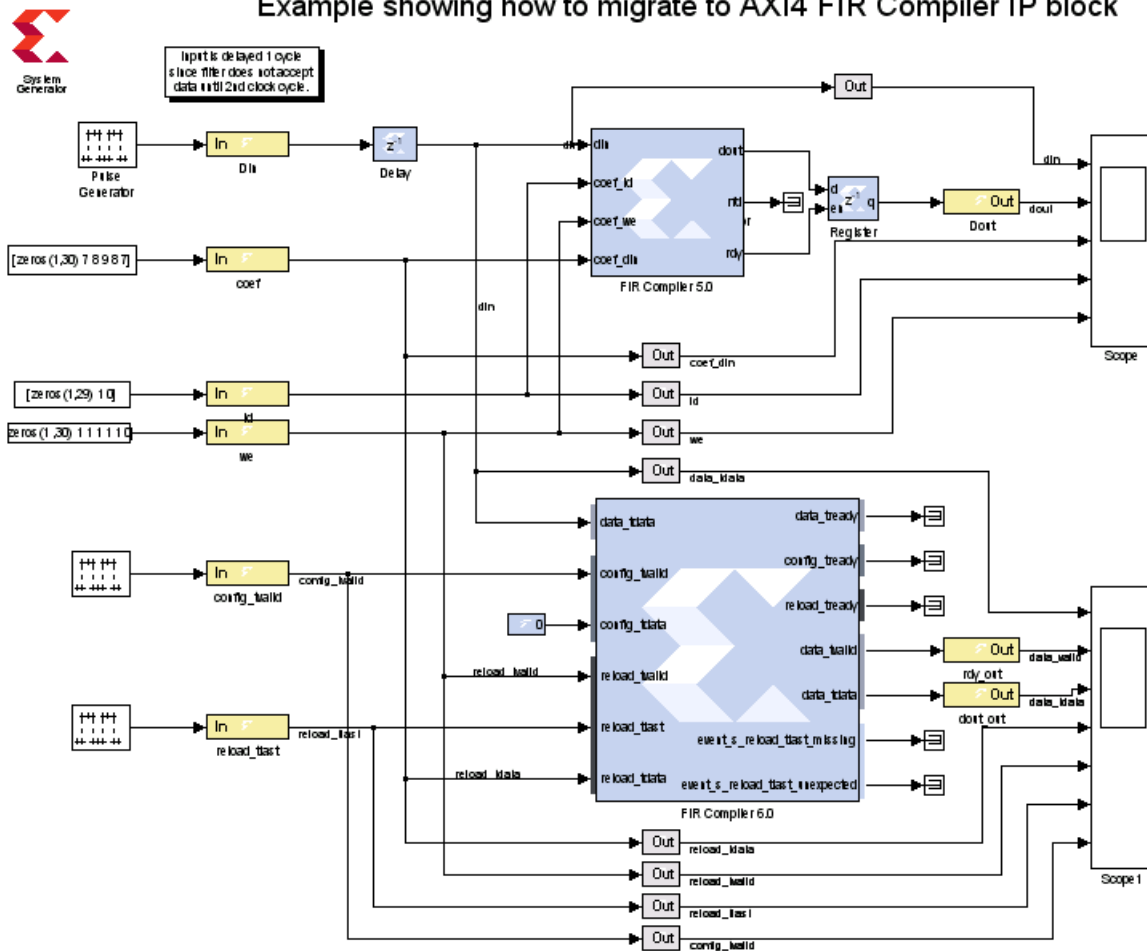

The figure below shows output simulation from the non-AXI, reloadable FIR Compiler block.

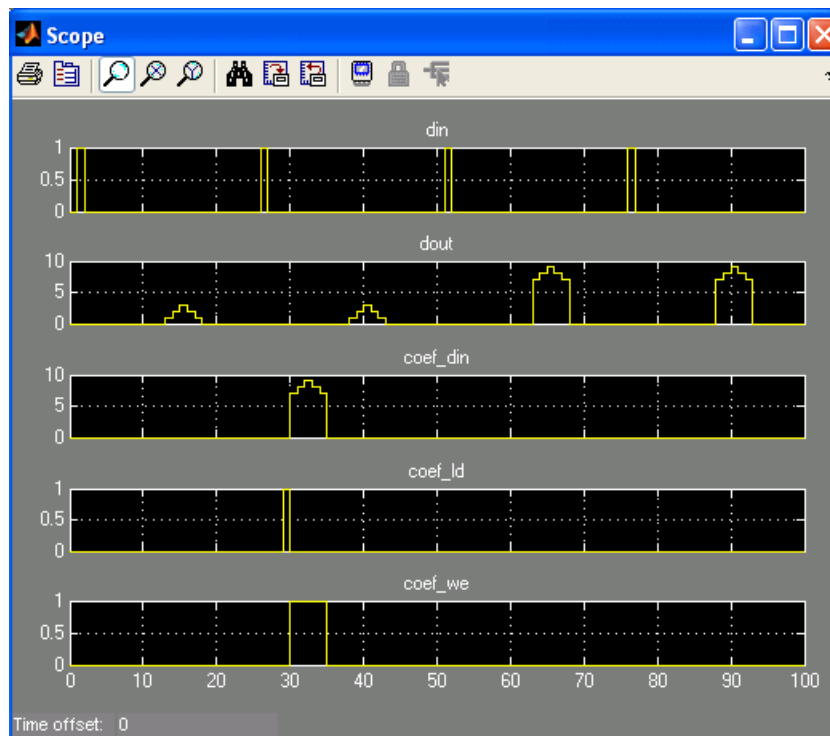

### Data Path and Control Signals:

As shown in the figure below, the sequence of events to reload new filter coefficients are quite different between the non-AXI and AXI4 versions as are briefly described next. Care must be taken to ensure that the following loading sequences are taken place.

1. `data_tdata`: AXI FIR output data based on the initial set of coefficients specified by the core ([1,2,3,2,1])
2. `reload_tdata` and `reload_tvalid`: Next is to load a new set of coefficients ([7 8 9 8 7]) into the `reload_tdata` input port. The `reload_tvalid` control signal must be high during this reload period. In this case, it must be high for 5 clock cycles.
3. `reload_tlast`: this signal must be high on the last coefficient data to indicate that the last data has been loaded
4. `config_tvalid`: finally, the reload data is now available for transfer. This control signal does not have to strobe high immediately after the `reload_tlast` assertion

The figure below shows output simulation from the AXI4, reloadable FIR Compiler block.

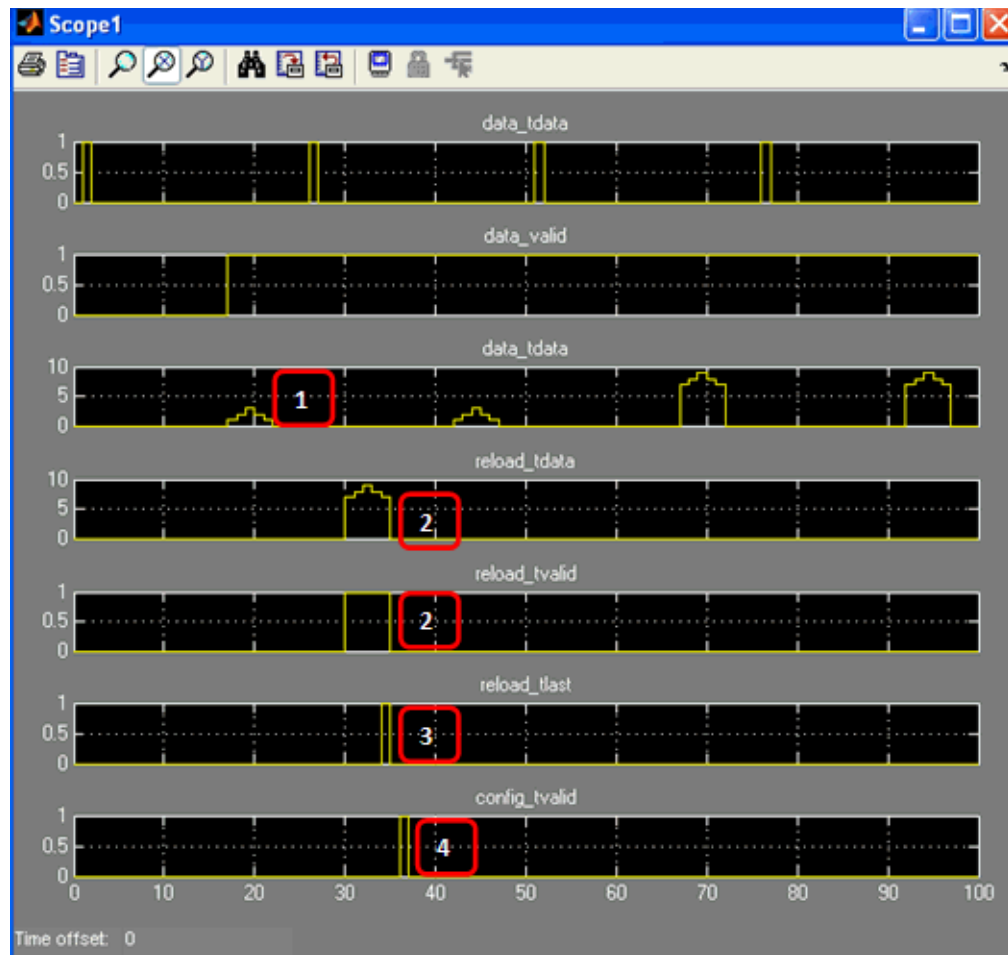

## LogiCORE™ Documentation

[LogiCORE IP FIR Compiler v6.3](#)

## Device Support

Kintex-7, Virtex-7, Artix-7, Zynq-7000, Virtex-6, Spartan-6

## From FIFO

This block is listed in the following Xilinx Blockset libraries: *Shared Memory, Floating-Point and Index*.



The Xilinx From FIFO block implements the trailing half of a first-in-first-out memory queue.

By asserting the read-enable input port `re`, data can be read from the FIFO using the data output port `dout`. The empty output port is asserted when the FIFO is empty. The percent full output port indicates the percentage of the FIFO that is full, represented with user-specified precision.

The From FIFO is implemented in hardware using the FIFO Generator LogiCORE. System Generator's hardware co-simulation interfaces allow the From FIFO block to be compiled and co-simulated in FPGA hardware. When used in System Generator co-simulation hardware, shared FIFOs facilitate high-speed transfers between the host PC and FPGA, and bolster the tool's real-time hardware co-simulation capabilities.

During netlisting, each pair of **From FIFO** and **To FIFO** blocks with the same name are stitched together as a BRAM-based **FIFO** block in the netlist. If a **From FIFO** or **To FIFO** block does not form a pair with another block, its input and output ports are pushed to the top level of System Generator design. A pair of matching blocks can exist anywhere in the hierarchy of the design, however, if two or more **From FIFO** or **To FIFO** blocks with the same name exist in the design, then an error is issued.

For backward compatibility, you can set the MATLAB global variable `xlSgSharedMemoryStitch` to "off" to bring System Generator back to the netlisting behavior before the 9.2 release. For example, from the MATLAB command line, enter the following:

```
global xlSgSharedMemoryStitch;
xlSgSharedMemoryStitch = 'off';
```

**Note:** The notion of bit and cycle accuracy is preserved only within individual synchronous islands. The shared FIFO block supports crossing clock domain boundaries and bit and cycle accuracy may not be maintained.

## Block Parameters

### Basic tab

Parameters specific to the Basic tab are as follows:

- **Shared memory name:** name of the shared FIFO. All FIFOs with the same name share the same physical FIFO.
- **Ownership:** indicates whether the memory is Locally owned or Owned elsewhere. A block that is Locally owned is responsible for creating an instance of the FIFO. A block that is Owned elsewhere attaches itself to a FIFO instance that has already been created.

### FIFO Implementation

**Memory Type:** This block implements FIFOs built from block RAM, distributed RAM, shift registers, or the 7 series, Virtex-6 and Virtex-5 FPGA built-in FIFOs. Memory primitives are

arranged in an optimal configuration based on the selected width and depth of the FIFO. The following table provides best-use recommendations for specific design requirements.

	Independent Clocks	Common Clock	Small Buffering	Medium-Large Buffering	High Performance	Minimal] Resources
Zynq-7000, 7 Series, Virtex-6, and Virtex-5 FPGA with Built-in FIFO	✓	✓		✓	✓	✓
Block RAM	✓	✓		✓	✓	✓
Shift Register		✓	✓		✓	
Distributed RAM	✓	✓	✓		✓	

#### Performance Options:

- **Standard FIFO:** FIFO will operate in Standard Mode.
- **First Word Fall Through:** FIFO will operate in First-Word Fall-Through (FWFT) mode. The First-Word Fall-Through feature provides the ability to look-ahead to the next word available from the FIFO without issuing a read operation. When data is available in the FIFO, the first word falls through the FIFO and appears automatically on the output. FWFT is useful in applications that require low-latency access to data and to applications that require throttling based on the contents of the data that are read. FWFT support is included in FIFOs created with block RAM, distributed RAM, or built-in FIFOs in the 7 series, Virtex-6 or Virtex-5 devices.

#### Implementation Options:

- Use Embedded Registers (when possible):  
In 7 series, Virtex-6, Virtex-5 and Virtex-4 FPGA block RAM and FIFO macros, embedded output registers are available to increase performance and add a pipeline register to the macros. This feature can be leveraged to add one additional cycle of latency to the FIFO core (DOUT bus and VALID outputs) or implement the output registers for FWFT FIFOs. The embedded registers available in 7 series, and Virtex-6 FPGAs can be reset (DOUT) to a default or user programmed value for common clock built-in FIFOs. See the topic **Embedded Registers in block RAM and FIFO Macros** in the [LogiCORE IP FIFO Generator 9.2 Product Specification](#).

**Depth:** specifies the number of words that can be stored. Range 16-64K.

**Bits of precision to use for %full signal:** specifies the bit width of the %full port. The binary point for this unsigned output is always at the top of the word. Thus, if for example precision is set to one, the output can take two values: 0.0 and 0.5, the latter indicating the FIFO is at least 50% full.

#### Optional Ports:

- **Provide asynchronous reset port:** Activates an optional asynchronous edge-triggered reset (rst) port on the block. Prior to Release 11.2, this reset was level-triggered and the block would remain in the reset mode if held high.
- **Provide percent full port:** Add a percent full output port to the block. Indicates the percentage of the FIFO that is full using the user-specified precision. This optional port is turned on by default for backward compatibility reasons.

## Output tab

### Output Type

- Specifies the data type of the output. Can be **Fixed-point** or **Floating-point**.  
Arithmetic Type: If the Output Type is specified as Fixed-point, you can select **Signed (2's comp)** or **Unsigned** as the Arithmetic Type.

### Fixed-point Precision

- ◆ **Number of bits:** specifies the bit location of the binary point of the output number, where bit zero is the least significant bit.
- ◆ **Binary point:** position of the binary point. in the fixed-point output

### Floating-point Precision

- ◆ **Single:** specifies single precision (32 bits)

Parameters in this tab are explained in the topic [Common Options in Block Parameter Dialog Boxes](#).

## LogiCORE™ Documentation

[LogiCORE IP FIFO Generator 9.2](#)

[LogiCORE IP Floating-Point Operator v6.1](#)

## Device Support

Zynq-7000, Artix-7, Virtex-7, Kintex-7, Virtex-6, Virtex-5, Virtex-4, Spartan-6, Spartan-3A/3AN/3A DSP, Spartan-3E, Spartan-3

Floating-Point support is restricted to the following devices:

Virtex-7, Kintex-7, Artix-7, Zynq-7000, Virtex-6, Spartan-6

## See Also

The following topics provide valuable insight into using and understanding the From FIFO block:

[To FIFO](#)

## From Register

This block is listed in the following Xilinx Blockset libraries: *Floating-Point and Index*.



The Xilinx From Register block implements the trailing half of a D flip-flop based register. The physical register can be shared among two designs or two portions of the same design.

The block reads data from a register that is written to by the corresponding To Register block. The `dout` port presents the output of the register. The bit width specified on the mask must match the width of the corresponding To Register block.

Starting with the 9.2 release, during netlisting, each pair of **From Register** and **To Register** blocks with the same name are stitched together as a single **Register** block in the netlist. If a **From Register** or **To Register** block does not form a pair with another block, its input and output ports are pushed to the top level of System Generator design. A pair of matching blocks can exist anywhere in the hierarchy of the design, however, if two or more **From Register** or **To Register** blocks with the same name exist in the design, then an error is issued.

For backward compatibility, you can set the MATLAB global variable `xlSgSharedMemoryStitch` to “off” to bring System Generator back to the netlisting behavior before the 9.2 release. For example, from the MATLAB command line, enter the following:

```
global xlSgSharedMemoryStitch;
xlSgSharedMemoryStitch = 'off';
```

## Block Parameters

The block parameters dialog box can be invoked by double-clicking the icon in your Simulink model.

### Basic tab

Parameters specific to the Basic Tab are as follows:

- **Shared Memory Name:** name of the shared register. There must be exactly one To Register and exactly one From Register block for a particular register name. In addition, the name must be distinct from all other shared memory names in the design.
- **Initial value:** specifies the initial value in the register.
- **Ownership and initialization:** indicates whether the register is Locally owned and initialized or Owned and initialized elsewhere. A block that is locally owned is responsible for creating an instance of the register. A block that is owned elsewhere attaches itself to a register instance that has already been created. As a result, if two shared register blocks are used in two different models during simulation, the model containing the locally owned block has to be started first.

### Output tab

#### Output Precision

- Specifies the data type of the output. Can be **Fixed-point** or **Floating-point**.  
Arithmetic Type: If the Output Type is specified as Fixed-point, you can select **Signed (2's comp)** or **Unsigned** as the Arithmetic Type.

#### Fixed-point Precision

- ♦ **Number of bits:** specifies the bit location of the binary point of the output number, where bit zero is the least significant bit.



- ◆ **Binary point:** position of the binary point. in the fixed-point output

Floating-point Precision

- ◆ **Single:** specifies single precision (32 bits)

Other parameters used by this block are explained in the topic [Common Options in Block Parameter Dialog Boxes](#).

## Crossing Clock Domain

When a To Register and From Register block pair are used to cross clock domain boundaries, a single register is implemented in hardware. This register is clocked by the To Register block clock domain. For example, assume a design has two clock domains, Domain\_A and Domain\_B. Also assume that a shared register pair are used to cross the two clock domains shown below.

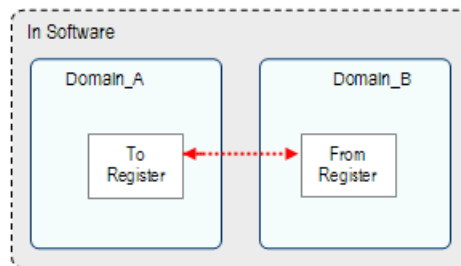

When the design is generated using the Multiple Subsystem Generator block, only one register is included in the design. The clock and clock enable register signals are driven from the Domain\_A domain.

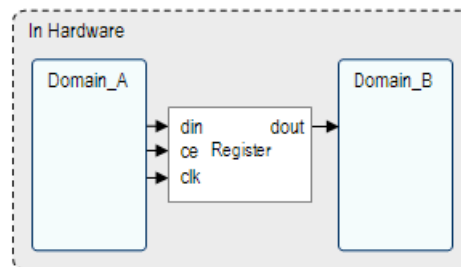

Crossing domains in this manner might be unsafe. To reduce the chance of metastability, include two Register blocks immediately following the From Register block to re-synchronize the data to the From Register's clock domain.

## See Also

The following topics provide valuable insight into using and understanding the From Register block:

[To Register](#)

## Gateway In

This block is listed in the following Xilinx Blockset libraries: *Basic Elements, Data Types, Floating-Point and Index.*



The Xilinx Gateway In blocks are the inputs into the Xilinx portion of your Simulink design. These blocks convert Simulink integer, double and fixed-point data types into the System Generator fixed-point type. Each block defines a top-level input port in the HDL design generated by System Generator.

While converting a double type to a System Generator fixed-point type, the Gateway In uses the selected overflow and quantization options. For overflow, the options are to saturate to the largest positive/smallest negative value, to wrap (for example, to discard bits to the left of the most significant representable bit), or to flag an overflow as a Simulink error during simulation. For quantization, the options are to round to the nearest representable value (or to the value furthest from zero if there are two equidistant nearest representable values), or to truncate (for example, to discard bits to the right of the least significant representable bit).

It is important to realize that overflow and quantization do not take place in hardware – they take place in the block software itself, before entering the hardware phase.

## Gateway Blocks

As listed below, the Xilinx *Gateway In* block is used to provide a number of functions:

- Converting data from Simulink integer, double and fixed-point types to the System Generator fixed-point type during simulation in Simulink.
- Defining top-level input ports in the HDL design generated by System Generator.
- Defining testbench stimuli when the **Create Testbench** box is checked in the System Generator token. In this case, during HDL code generation, the inputs to the block that occur during Simulink simulation are logged as a logic vector in a data file. During HDL simulation, an entity that is inserted in the top level testbench checks this vector and the corresponding vectors produced by Gateway Out blocks against expected results.
- Naming the corresponding port in the top level HDL entity.

## Block Parameters

The block parameters dialog box can be invoked by double-clicking the icon in your Simulink model.

### Basic Tab

Parameters specific to the Basic Tab are as follows:

#### Output Precision

Specifies the output data type. Can be **Boolean**, **Fixed-point**, or **Floating-point**.

Arithmetic Type: If the Output Type is specified as Fixed-point, you can select **Signed (2's comp)** or **Unsigned** as the Arithmetic Type.

#### Fixed-point Precision

- ◆ **Number of bits:** specifies the bit location of the binary point, where bit zero is the least significant bit.

- ◆ **Binary point:** specifies the bit location of the binary point, where bit zero is the least significant bit.

#### Floating-point Precision

- **Single:** Specifies single precision (32 bits)
- **Double:** Specifies double precision (64 bits)
- **Custom:** Activates the field below so you can specify the Exponent width and the Fraction width.

**Exponent width:** Specify the exponent width

**Fraction width:** Specify the fraction width

#### Quantization

Quantization errors occur when the number of fractional bits is insufficient to represent the fractional portion of a value. The options are to **Truncate** (for example, to discard bits to the right of the least significant representable bit), or to **Round(unbiased: +/- inf)** or **Round (unbiased: even values)**.

**Round(unbiased: +/- inf)** also known as "Symmetric Round (towards +/- inf)" or "Symmetric Round (away from zero)". This is similar to the Matlab round() function. This method rounds the value to the nearest desired bit away from zero and when there is a value at the midpoint between two possible rounded values, the one with the larger magnitude is selected. For example, to round 01.0110 to a Fix\_4\_2, this yields 01.10, since 01.0110 is exactly between 01.01 and 01.10 and the latter is further from zero.

#### Overflow

Overflow errors occur when a value lies outside the representable range. For overflow the options are to **Saturate** to the largest positive/smallest negative value, to **Wrap** (for example, to discard bits to the left of the most significant representable bit), or to **Flag as error** (an overflow as a Simulink error) during simulation. **Flag as error** is a simulation only feature. The hardware generated is the same as when **Wrap** is selected.

## Gateway Out

This block is listed in the following Xilinx Blockset libraries: *Basic Elements, Data Types, Floating-Point and Index.*



Xilinx Gateway Out blocks are the outputs from the Xilinx portion of your Simulink design. This block converts the System Generator fixed-point or floating-point data type into a Simulink integer, single, double or fixed-point data type.

According to its configuration, the Gateway Out block can either define an output port for the top level of the HDL design generated by System Generator, or be used simply as a test point that is trimmed from the hardware representation

### Gateway Blocks

As listed below, the Xilinx *Gateway Out* block is used to provide the following functions:

- Convert data from a System Generator fixed-point or floating-point data type into a Simulink integer, single, double or fixed-point data type.
- Define I/O ports for the top level of the HDL design generated by System Generator. A Gateway Out block defines a top-level output port.
- Define testbench result vectors when the System Generator Create Testbench box is checked. In this case, during HDL code generation, the outputs from the block that occur during Simulink simulation are logged as logic vectors in a data file. For each top level port, an HDL component is inserted in the top-level testbench that checks this vector against expected results during HDL simulation.
- Name the corresponding output port on the top-level HDL entity.

### Block Parameters

Parameters specific to the dialog box are as follows

- **Propagate data type to output:** This option is useful when you instantiate a System Generator design as a sub-system into a Simulink design. Instead of using a Simulink double as the output data type by default, the System Generator data type is propagated to an appropriate Simulink data type according to the following table:

System Generator Data Type	Simulink Data Type
XFloat_8_24	single
XFloat_11_53	double
Custom floating-point precision data type exponent width and fraction width less than those for single precision	single
Custom floating-point precision data type with exponent width or fraction width greater than that for single precision	double
XFix_<width>_<binpt>	sfix<width>_EN<binpt>
UFix_<width>_<binpt>	ufix<width>_EN<binpt>
XFix_<width>_0 where width is 8, 16 or 32	int<width> where width is 8, 16 or 32
UFix_<width>_0 where width is 8, 16 or 32	uint<width> where width is 8, 16 or 32

System Generator Data Type	Simulink Data Type
XFix_<width>_0 where width is other than 8, 16 or 32	sfix<width>
UFix_<width>_0 where width is other than 8, 16 or 32	ufix<width>

- Translate into Output Port:** Having this box unchecked prevents the gateway from becoming an actual output port when translated into hardware. This checkbox is on by default, enabling the output port. When this option is not selected, the Gateway Out block is used only during debugging, where its purpose is to communicate with Simulink Sink blocks for probing portions of the design. In this case, the Gateway Out block will turn gray in color, indicating that the gateway will not be translated into an output port.
- IOB Timing Constraint:** In hardware, a Gateway Out is realized as a set of input/output buffers (IOBs). There are three ways to constrain the timing on IOBs. They are None, Data Rate, and Data Rate, Set 'FAST' Attribute.

If **None** is selected, no timing constraints for the IOBs are put in the user constraint file (.xcf if using the XST synthesis tool, .ncf otherwise) produced by System Generator. This means the paths from the IOBs to synchronous elements are not constrained.

If **Data Rate** is selected, the IOBs are constrained at the data rate at which the IOBs operate. The rate is determined by System Clock Period provided on the System Generator token and the sample rate of the Gateway relative to the other sample periods in the design. For example, the following OFFSET = OUT constraints are generated for a Gateway Out named 'Dout' that is running at the system period of 10 ns:

```
# Offset out constraints
NET "Dout(0)" OFFSET = OUT : 10.0 : AFTER "clk";
NET "Dout(1)" OFFSET = OUT : 10.0 : AFTER "clk";
NET "Dout(2)" OFFSET = OUT : 10.0 : AFTER "clk";
```

If **Data Rate, Set 'FAST' Attribute** is selected, the OFFSET = OUT constraints described above are produced. In addition, a FAST slew rate attribute is generated for each IOB. This reduces delay but increases noise and power consumption. For the previous example, the following additional attributes are added to the .xcf (or .ncf) file

```
NET "Dout(0)" FAST;
NET "Dout(1)" FAST;
NET "Dout(2)" FAST;
```

- Specify IOB Location Constraints:** Checking this option allows IOB location constraints to be specified.
- IOB Pad Locations, e.g. {'MSB', ..., 'LSB'}:** IOB pin locations can be specified as a cell array of strings in this edit box. The locations are package-specific. For the above example, if a Virtex®-E 2000 in a FG680 package is used, the location constraints for the Dout bus can be specified in the dialog box as {'B34', 'D33', 'B35'}. This is translated into constraints in the .xcf (or .ncf) file in the following way:

```
# Loc constraints
NET "Dout(0)" LOC = "B35";
NET "Dout(1)" LOC = "D33";
NET "Dout(2)" LOC = "B34";
```

Other parameters used by this block are explained in the topic [Common Options in Block Parameter Dialog Boxes](#).

## Indeterminate Probe

*This block is listed in the following Xilinx Blockset libraries: Tools and Index.*

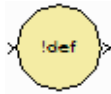

The output of the Xilinx Indeterminate Probe indicates whether the input data is indeterminate (MATLAB value NaN). An indeterminate data value corresponds to a VHDL indeterminate logic data value of 'X'.

The probe accepts any Xilinx signal as input and produces a double signal as output. Indeterminate data on the probe input will result in an assertion of the output signal indicated by a value one. Otherwise, the probe output is zero.

# Interleaver/De-interleaver 6.0

This block is listed in the following Xilinx Blockset libraries: *Communication and Index*.

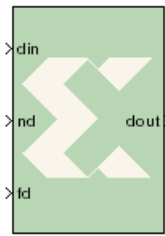

Interleaver/De-interleaver 6.0

The Xilinx Interleaver Deinterleaver block implements an interleaver or a deinterleaver. An interleaver is a device that rearranges the order of a sequence of input symbols. The term symbol is used to describe a collection of bits. In some applications, a symbol is a single bit. In others, a symbol is a bus.

The classic use of interleaving is to randomize the location of errors introduced in signal transmission. Interleaving spreads a burst of errors out so that error correction circuits have a better chance of correcting the data.

If a particular interleaver is used at the transmit end of a channel, the inverse of that interleaver must be used at the receive end to recover the original data. The inverse interleaver is referred to as a de-interleaver.

Two types of interleaver/de-interleavers can be generated with this LogiCORE: Forney Convolutional and Rectangular Block. Although they both perform the general interleaving function of rearranging symbols, the way in which the symbols are rearranged and their methods of operation are entirely different. For very large interleavers, it might be preferable to store the data symbols in external memory. The core provides an option to store data symbols in internal FPGA RAM or in external RAM.

## Forney Convolutional Operation

In the figure below, shows the operation of a Forney Convolutional Interleaver. The core operates as a series of delay line shift registers. Input symbols are presented to the input commutator arm on DIN. Both commutator arms start at branch 0 and advance to the next branch after the next rising clock edge. After the last branch (B-1) has been reached, the commutator arms both rotate back to branch 0 and the process is repeated.

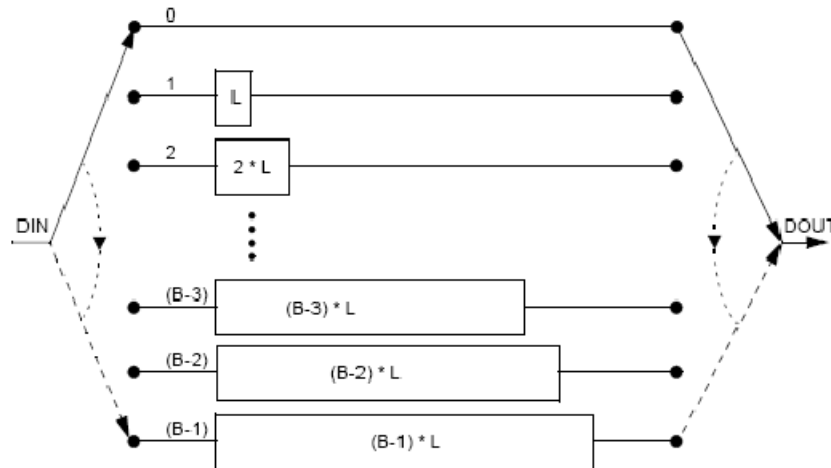

In the figure above, the branches increase in length by a uniform amount, L. The core allows interleavers to be specified in this way, or the branch lengths can be passed in using a file, allowing each branch to be any length.

Although branch 0 appears to be a zero-delay connection, there will still be a delay of a number of clock cycles between DIN and DOUT because of the fundamental latency of the core. For clarity, this is not illustrated in the figure.

The only difference between an interleaver and a de-interleaver is that branch 0 is the longest in the deinterleaver and the branch length is decremented by  $L$  rather than incremented. Branch  $(B-1)$  has length 0. This is illustrated in the figure below:

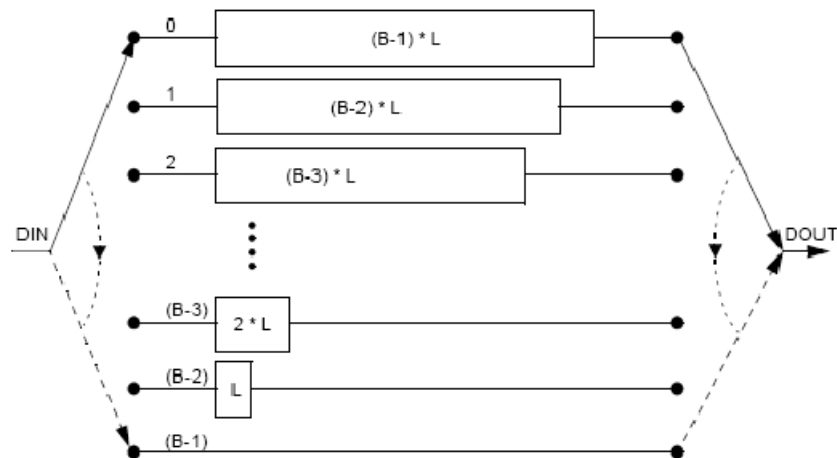

If a file is used to specify the branch lengths, as shown below, it is arbitrary whether the resulting core is called an interleaver or de-interleaver. All that matters is that one must be the inverse of the other. If a file is used, each branch length is individually controllable. This is illustrated in the figure below. For the file syntax, please consult the LogiCORE product specification.

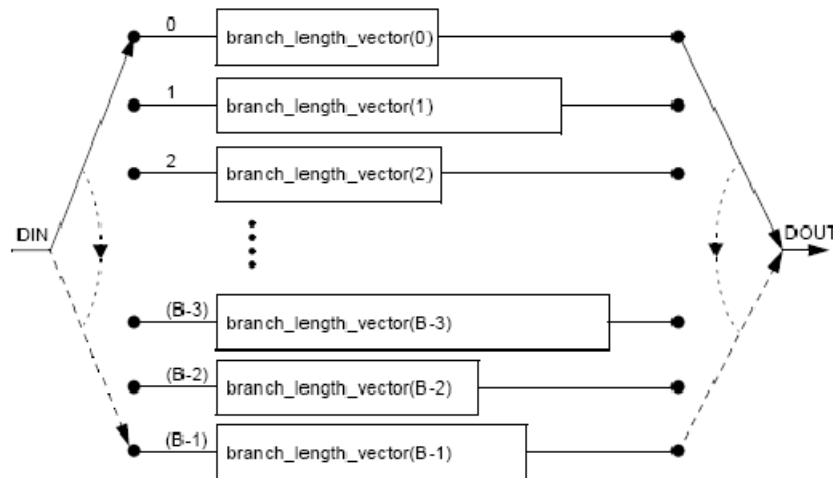

The reset pin (`rst`) sets the commutator arms to branch 0, but does not clear the branches of data.

## Rectangular Block Operation

The Rectangular Block Interleaver works by writing the input data symbols into a rectangular memory array in a certain order and then reading them out in a different, mixed-up order. The input symbols must be grouped into blocks. Unlike the Convolutional Interleaver, where symbols can be continuously input, the Rectangular Block Interleaver inputs one block of symbols and then outputs that same block with the symbols rearranged. No new inputs can be accepted while the interleaved symbols from the previous block are being output.



The rectangular memory array is composed of a number of rows and columns as shown in the following figure.

Row\Column	0	1	...	(C-2)	(C-1)
0					
1					
.					
.					
(R-2)					
(R-1)					

The Rectangular Block Interleaver operates as follows:

1. All the input symbols in an entire block are written row-wise, left to right, starting with the top row.
2. Inter-row permutations are performed if required.
3. Inter-column permutations are performed if required.
4. The entire block is read column-wise, top to bottom, starting with the left column.

The Rectangular Block De-interleaver operates in the reverse way:

1. All the input symbols in an entire block are written column-wise, top to bottom, starting with the left column.
2. Inter-row permutations are performed if required.
3. Inter-column permutations are performed if required.
4. The entire block is read row-wise, left to right, starting with the top row.

Refer to the Interleaver/De-Interleaver v6.0 Product Specification for examples and more detailed information on the Rectangular Block Interleaver.

## Block Parameters

The block parameters dialog box can be invoked by double-clicking the icon in your Simulink model.

### Basic Parameters Tab

Parameters specific to the Basic Parameters tab are as follows:

- **Memory Style:** Select **Distributed** if all the Block Memories are required elsewhere in the design; select **Block** to use Block Memory where ever possible; select **Automatic** and let Sysgen use the most appropriate style of memory for each case, based on the required memory depth.
- **Symbol Width:** this is the bus width of the DIN and DOUT ports.
- **Type:** Select **Forney Convolutional** or **Rectangular Block**.
- **Mode:** Select **Interleaver** or **Deinterleaver**
- **Symbol memory:** Specifies whether or not the data symbols are stored in **Internal** FPGA RAM or in **External** RAM.

## Forney Parameters Tab

Parameters specific to the Forney Parameters tab are as follows:

### Dimensions

- **Number of branches:** 1 to 256 (inclusive)

### Architecture

- **ROM-based:** Look-up table ROMs are used to compute some of the internal results in the block
- **Logic-based:** Logic circuits are used to compute some of the internal results in the block

Which option is best depends on the other core parameters. You should try both options to determine the best results. This parameter has no effect on the block behavior.

### Configurations

- **Number of configurations:** If greater than 1, the block is generated with `CONFIG_SEL` and `NEW_CONFIG` inputs. The parameters for each configuration are defined in a COE file. The number of parameters defined must exactly match the number of configurations specified.

### Length of Branches

- **Value:** 1 to MAX (inclusive). MAX depends on the number of branches and size of block input. Branch length must be an array of either length one or number of branches. If the array size is one, the value is used as a constant difference between consecutive branches. Otherwise, each branch has a unique length.
- **COE File:** The branch lengths are specified from a file
- Branch length descriptions for Forney SID.
  - ◆ **constant\_difference\_between\_consecutive\_branches:** specified by the **Value** parameter
  - ◆ **use\_coe\_file\_to\_define\_branch\_lengths:** location of file is specified by the **COE File** parameter
  - ◆ **coe\_file\_defines\_individual\_branch\_lengths\_for\_every\_branch\_in\_each\_configuration** : location of file is specified by the **COE File** parameter
  - ◆ **coe\_file\_defines\_branch\_length\_constant\_for\_each\_configuration:** location of file is specified by the **COE File** parameter

## Rectangular Parameters #1 Tab

Parameters specific to the Rectangular Parameters #1 tab are as follows:

### Number of Rows

- **Value:** This parameter is relevant only when the **Constant** row type is selected. The number of rows is fixed at this value.
- **Row Port Width:** This parameter is relevant only when the **Variable** row type is selected. It sets the width of the ROW input bus. The smallest possible value should be used to keep the underlying LogiCORE as small as possible.
- **Minimum Number of Rows:** This parameter is relevant only when the **Variable** row type is selected. In this case, the core has to potentially cope with a wide range of possible values for the number of rows. If the smallest value that will actually occur is known, then the amount of logic in the LogiCORE can sometimes be reduced. The largest possible value should be used for this parameter to keep the core as small as possible.

- **Number of Values:** This parameter is relevant only when the **Selectable** row type is selected. This parameter defines how many valid selection values have been defined in the COE file. You should only add the number of select values you need.

#### Row Type

- **Constant:** The number of rows is always equal to the Row Constant Value parameter.
- **Variable:** The number of rows is sampled from the ROW input at the start of each new block. Row permutations are not supported for the variable row type.
- **Selectable:** ROW\_SEL is sampled at the start of each new block. This value is then used to select from one of the possible values for the number of rows provided in the COE file.

#### Number of Columns

- **Value:** This parameter is relevant only when the **Constant** column type is selected. The number of columns is fixed at this value.
- **COL Port Width:** This parameter is relevant only when the **Variable** column type is selected. It sets the width of the COL input bus. The smallest possible value should be used to keep the underlying LogiCORE as small as possible.
- **Minimum Number of Columns:** This parameter is relevant only when the **Variable** column type is selected. In this case, the core has to potentially cope with a wide range of possible values for the number of columns. If the smallest value that will actually occur is known, then the amount of logic in the LogiCORE can sometimes be reduced. The largest possible value should be used for this parameter to keep the core as small as possible.
- **Number of Values:** This parameter is relevant only when the **Selectable** column type is selected. This parameter defines how many valid selection values have been defined in the COE file. You should only add the number of select values you need.

### Column Type

- **Constant:** The number of columns is always equal to the Column Constant Value parameter.
- **Variable:** The number of columns is sampled from the COL input at the start of each new block. Column permutations are not supported for the variable column type.
- **Selectable:** COL\_SEL is sampled at the start of each new block. This value is then used to select from one of the possible values for the number of columns provided in the COE file.

## Rectangular Parameters #2 Tab

Parameters specific to the Rectangular Parameters #2 tab are as follows:

### Permutations Configuration

#### Row permutations:

- ◆ **None:** This tells System Generator that row permutations are not to be performed
- ◆ **Use COE file:** This tells System Generator that a row permute vector exists in the COE file, and that row permutations are to be performed. Remember this is possible only for unpruned interleaver/deinterleavers.

#### Column permutations:

- ◆ **None:** This tells System Generator that column permutations are not to be performed
- ◆ **Use COE file:** This tells System Generator that a column permute vector exists in the COE file, and that column permutations are to be performed. Remember this is possible only for unpruned interleaver/deinterleavers.

**COE File:** Specify the pathname to the COE file.

### Block Size

- **Value:** This parameter is relevant only when the **Constant** block size type is selected. The block size is fixed at this value.
- **BLOCK\_SIZE Port Width:** This parameter is relevant only if the **Variable** block size type is selected. It sets the width of the BLOCK\_SIZE input bus. The smallest possible value should be used to keep the core as small as possible.

### Block Size Type

- **Constant:** The block size never changes. The block can be pruned (block size < row \* col). The block size must be chosen so that the last symbol is on the last row. An unpruned interleaver will use a smaller quantity of FPGA resources than a pruned one, so pruning should be used only if necessary.
- **Rows\*Columns:** If the number of rows and columns is constant, selecting this option has the same effect as setting the block size type to constant and entering a value of rows \* columns for the block size.

If the number of rows or columns is not constant, selecting this option means the core will calculate the block size automatically whenever a new row or column value is sampled. Pruning is impossible with this block size type.

- **Variable:** Block size is sampled from the BLOCK\_SIZE input at the beginning of every block. The value sampled on BLOCK\_SIZE must be such that the last symbol falls on the last row, as previously described.

If the block size is already available external to the core, selecting this option is usually more efficient than selecting “rows \* columns” for the block size type. Row and column permutations are not supported for the **Variable** block size type.

## Port Parameters tab

Parameters specific to the Port Parameters tab are as follows:

### Optional Pins

The following is a brief description of each optional port. Refer to the associated Interleaver Deinterleaver 6.0 LogiCORE product specification for a more detailed description.

- **ROW\_VALID**: This optional output is available when a variable number of rows is selected.
- **BLOCK\_SIZE\_VALID**: This optional output is available when the block size is not constant, that is, if the block size type is either **Variable** or equal to **Rows \* Columns**.
- **CE**: When CE is deasserted (Low), all the synchronous inputs are ignored and the block remains in its current state.
- **RFD**: RFD (Ready for Data) indicates that the core is ready to sample new data on DIN.
- **ROW\_SEL\_VALID**: This optional output is available when a selectable number of rows is chosen.
- **BLOCK\_START**: This output is asserted High when the first symbol of a block appears on DOUT.
- **SCLR**: When SCLR is asserted (High), all the block flip-flops are synchronously initialized.
- **RFFD**: When RFFD (Ready for First Data) is asserted High, it indicates that FD can be safely asserted without affecting any processing for previous blocks.
- **COL\_VALID**: This optional output is available when a variable number of columns is selected. If an illegal value is sampled on the COL input, COL\_VALID will go Low a predefined number of clock cycles later.
- **BLOCK\_END**: BLOCK\_END is asserted High when the last symbol of a block appears on DOUT.
- **NDO**: New Data Out (NDO) is a time-delayed version of the ND input. A new symbol is output on DOUT for every symbol input on DIN
- **FDO**: First Data Out (FDO) is a time-delayed version of the FD input. FDO is asserted High when the value sampled on DIN at the time of the FD pulse appears on DOUT.
- **COL\_SEL\_VALID**: This optional output is available when a selectable number of columns is chosen.
- **ND**: When this optional New Data input is sampled logic-High, it signals the block that a new symbol on DIN should be sampled on the same rising clock edge.
- **RDY**: The RDY (Ready) output is similar to NDO. It signals valid data on DOUT. The difference from NDO is that RDY is not asserted until the input symbol sampled with the first FD pulse finally appears on DOUT

Parameters specific to the Port Parameters tab are as follows:

- **Pipelining**: Pipelines the underlying LogiCORE for **Minimum**, **Medium**, or **Maximum** performance

Other parameters used by this block are explained in the topic [Common Options in Block Parameter Dialog Boxes](#).

## How to Migrate an Interleaver De-Interleaver 5.1 block to 6.0

The following instructions apply to both the Interleaver and De-interleaver blocks. The following figure illustrates the Interleaver Deinterleaver 5.1 input ports:

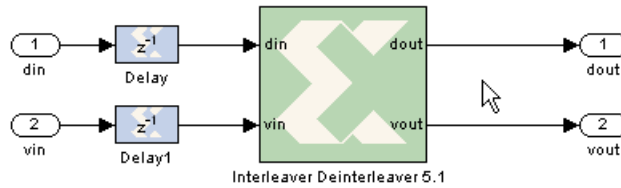

### Driving the Now Exposed fd (First Data) Input Port

Unlike the 5.1 version of the block, the `fd` (First Data) input pin is now exposed on the v6.0 version. It is now required to drive this input with correct signal sequences in relative to the `nd` (New Data) input signal. A single pulse is required at the `fd` input and it has to be lined up with the `nd` signal as shown in the figure below.

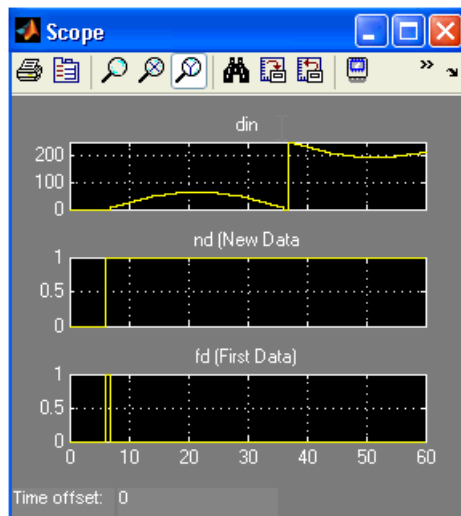

To accomplish this, you can use a simple single-shot circuit (Rising Edge Detector) to detect a low-to-high transition from *vin*. See the following diagram:

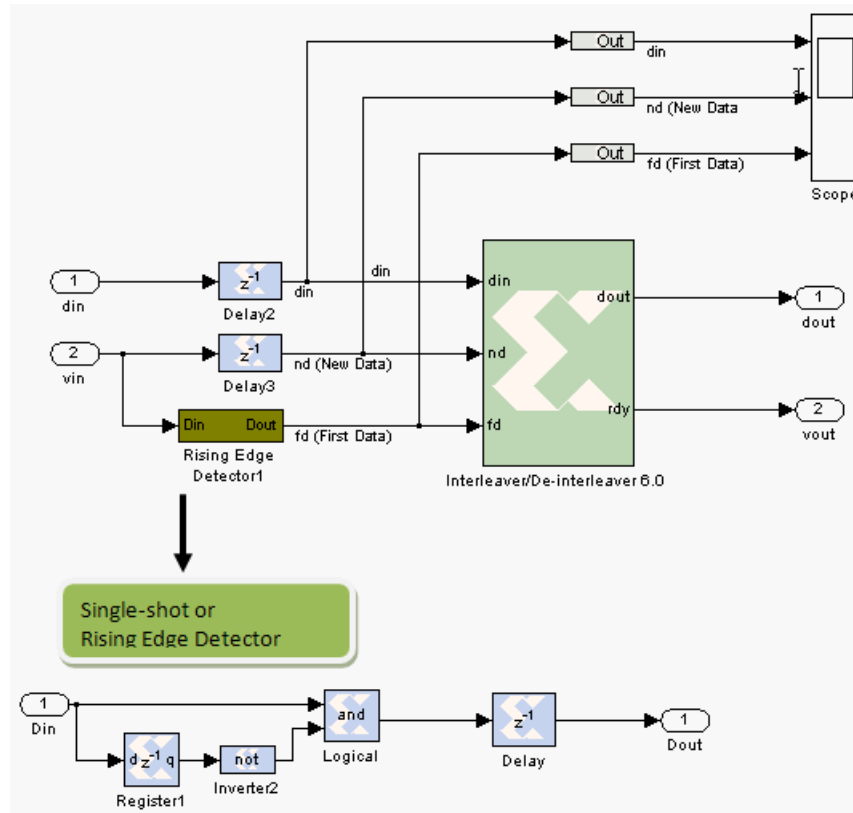

### How to Specify Unique Lengths for Each Branch of the Interleaver DeInterleaver v6.0 block

Assume the previous Interleaver Deinterleaver 5.1 block is setup with 3 branches with lengths 2, 4, and 5 as shown below:

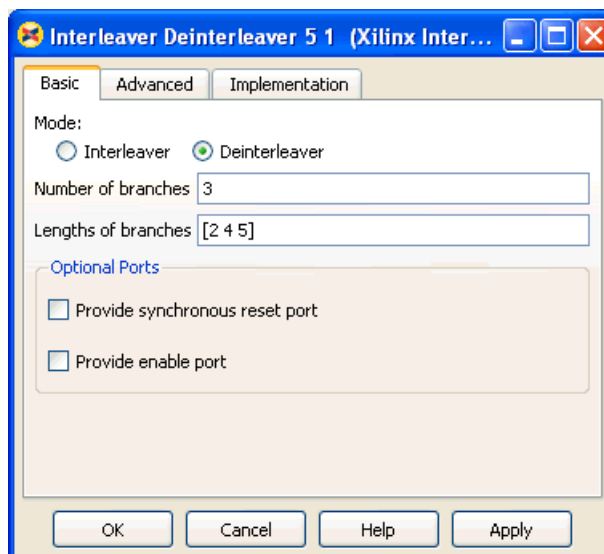

To setup the Interleaver Deinterleaver v6.0 block in a similar fashion, do the following:

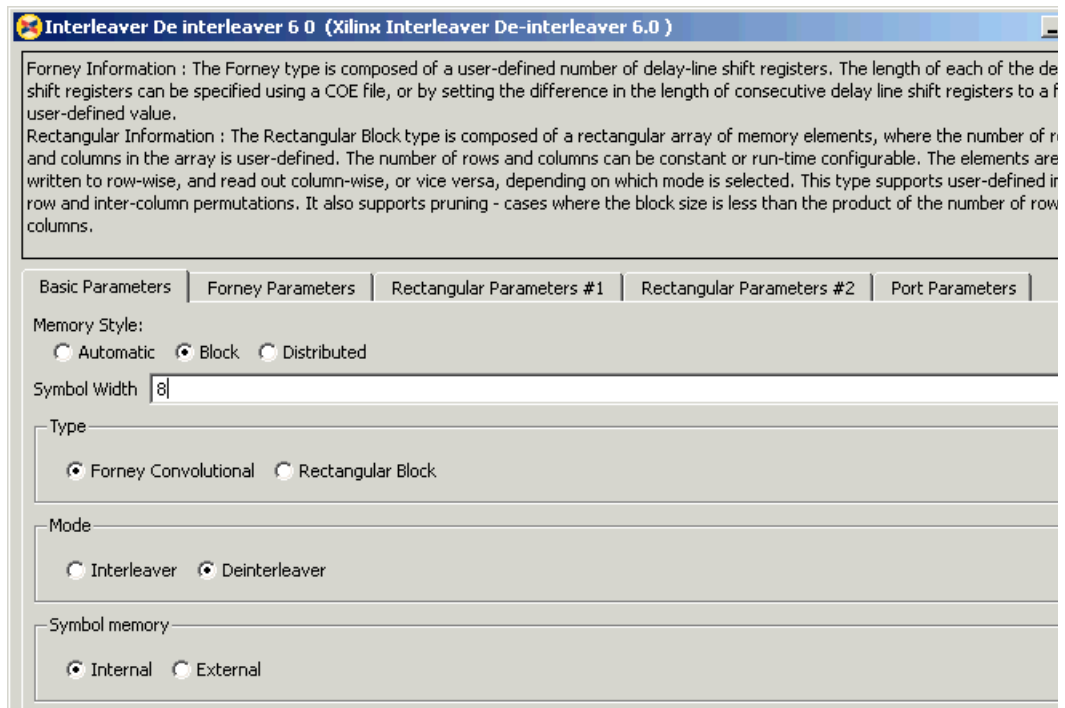

1. Set the **Symbol Width** to the input data width of the `din` port, in this case 8.
2. Select the **Deinterleaver** mode.
3. Select the appropriate **Branch length descriptions for Forney SID** as shown below
4. Set the unique length of each branch using the `coef.coe` file. You can use the `pwd` command to specify a relative pathname to the file:

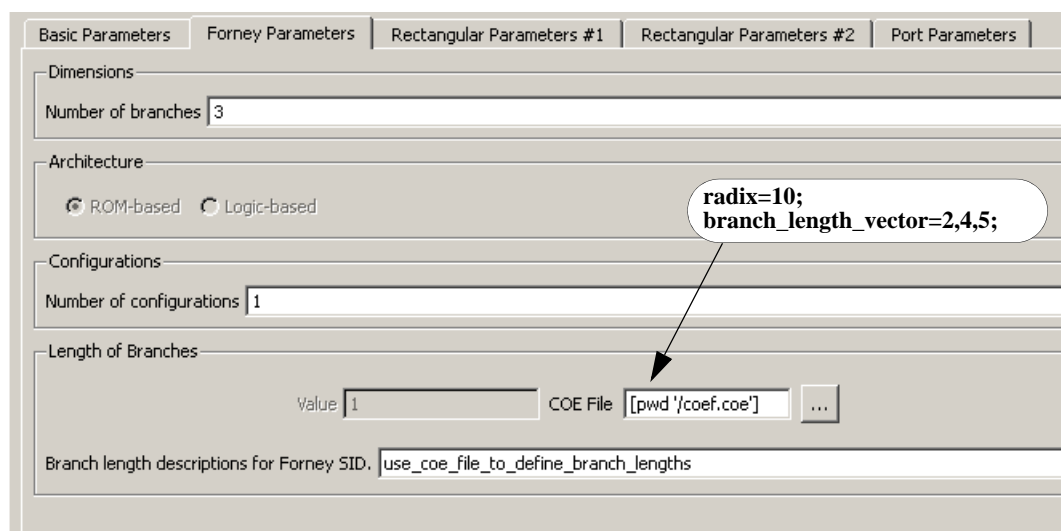

## LogiCORE™ Documentation

[LogiCORE IP Interleaver/De-interleaver v6.0](#)



## Device Support

Virtex-7 and Kintex-7, Virtex-6, Virtex-5, Virtex-4,  
Spartan-6, Spartan-3/XA, Spartan-3E/XA, Spartan-3A/3AN/3A DSP/XA

## Interleaver/De-interleaver 7.0

This block is listed in the following Xilinx Blockset libraries: AXI, Communication and Index.

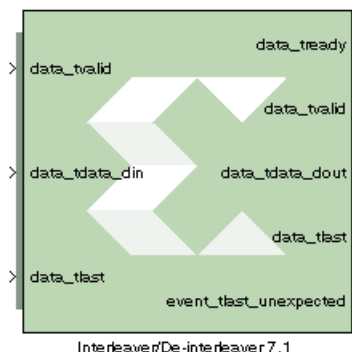

The Xilinx Interleaver Deinterleaver block implements an interleaver or a deinterleaver using an AXI4-compliant block interface. An interleaver is a device that rearranges the order of a sequence of input symbols. The term symbol is used to describe a collection of bits. In some applications, a symbol is a single bit. In others, a symbol is a bus.

The classic use of interleaving is to randomize the location of errors introduced in signal transmission. Interleaving spreads a burst of errors out so that error correction circuits have a better chance of correcting the data.

If a particular interleaver is used at the transmit end of a channel, the inverse of that interleaver must be used at the receive end to recover the original data. The inverse interleaver is referred to as a de-interleaver.

Two types of interleaver/de-interleavers can be generated with this LogiCORE: Forney Convolutional and Rectangular Block. Although they both perform the general interleaving function of rearranging symbols, the way in which the symbols are rearranged and their methods of operation are entirely different. For very large interleavers, it might be preferable to store the data symbols in external memory. The core provides an option to store data symbols in internal FPGA RAM or in external RAM.

### Forney Convolutional Operation

In the figure below, shows the operation of a Forney Convolutional Interleaver. The core operates as a series of delay line shift registers. Input symbols are presented to the input commutator arm on DIN. Output symbols are extracted from the output commutator arm on DOUT. DIN and DOUT are fields in the AXI Data Input and Data Output channels, respectively. Output symbols are extracted from the output commutator arm on DOUT. Both commutator arms start at branch 0 and advance to the next branch after the next rising clock edge. After the last branch (B-1) has been reached, the commutator arms both rotate back to branch 0 and the process is repeated.

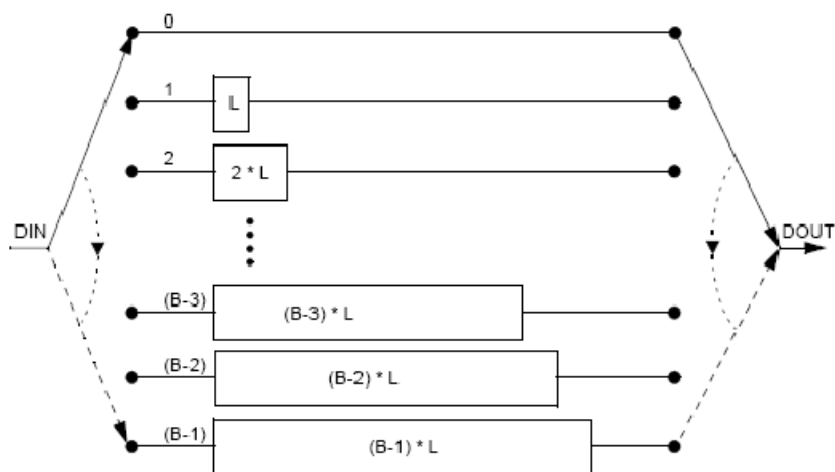

In the figure above, the branches increase in length by a uniform amount,  $L$ . The core allows interleavers to be specified in this way, or the branch lengths can be passed in using a file, allowing each branch to be any length.

Although branch 0 appears to be a zero-delay connection, there will still be a delay of a number of clock cycles between DIN and DOUT because of the fundamental latency of the core. For clarity, this is not illustrated in the figure.

The only difference between an interleaver and a de-interleaver is that branch 0 is the longest in the deinterleaver and the branch length is decremented by L rather than incremented. Branch (B-1) has length 0. This is illustrated in the figure below:

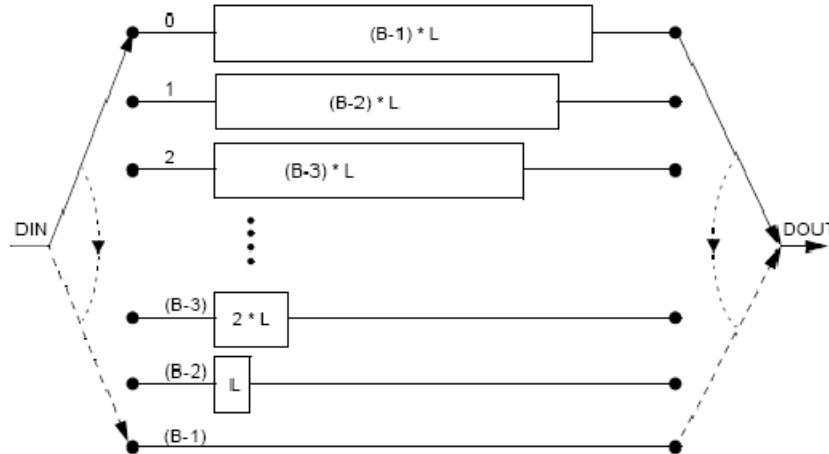

If a file is used to specify the branch lengths, as shown below, it is arbitrary whether the resulting core is called an interleaver or de-interleaver. All that matters is that one must be the inverse of the other. If a file is used, each branch length is individually controllable. This is illustrated in the figure below. For the file syntax, please consult the LogiCORE product specification.

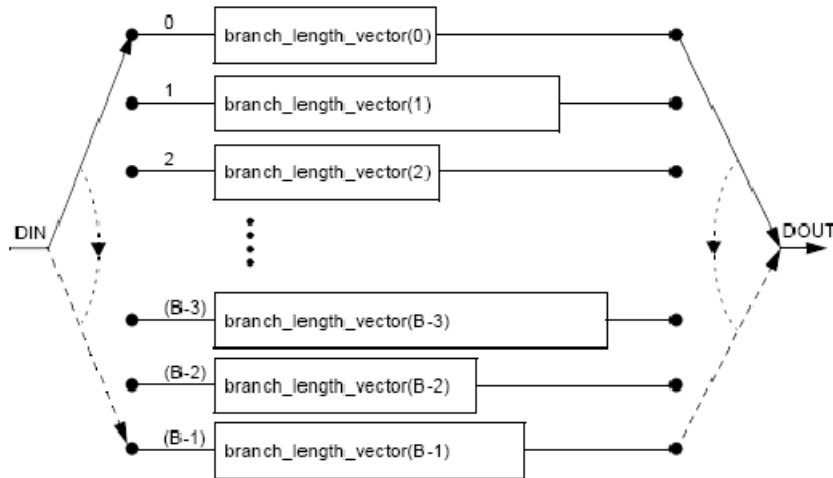

The reset pin (`aresetn`) sets the commutator arms to branch 0, but does not clear the branches of data.

## Configuration Swapping

It is possible for the core to store a number of pre-defined configurations. Each configuration can have a different number of branches and branch length constant. It is even possible for each configuration to have every individual branch length defined by file.

The configuration can be changed at any time by sending a new CONFIG\_SEL value on the AXI Control Channel. This value takes effect when the next block starts. The core assumes all configurations are either for an interleaver or de-interleaver, depending on what was selected in the GUI. It is possible to switch between interleaving and de-interleaving by defining the individual branch lengths for every branch of each configuration. The details for each configuration are specified in a COE file.

For details, please consult the Configuration Swapping section of the document [LogiCORE IP Interleaver/De-interleaver v7.0 Product Specification](#).

## Rectangular Block Operation

The Rectangular Block Interleaver works by writing the input data symbols into a rectangular memory array in a certain order and then reading them out in a different, mixed-up order. The input symbols must be grouped into blocks. Unlike the Convolutional Interleaver, where symbols can be continuously input, the Rectangular Block Interleaver inputs one block of symbols and then outputs that same block with the symbols rearranged. No new inputs can be accepted while the interleaved symbols from the previous block are being output.

The rectangular memory array is composed of a number of rows and columns as shown in the following figure.

Row\Column	0	1	...	(C-2)	(C-1)
0					
1					
.					
.					
(R-2)					
(R-1)					

The Rectangular Block Interleaver operates as follows:

1. All the input symbols in an entire block are written row-wise, left to right, starting with the top row.
2. Inter-row permutations are performed if required.
3. Inter-column permutations are performed if required.
4. The entire block is read column-wise, top to bottom, starting with the left column.

The Rectangular Block De-interleaver operates in the reverse way:

1. All the input symbols in an entire block are written column-wise, top to bottom, starting with the left column.
2. Inter-row permutations are performed if required.
3. Inter-column permutations are performed if required.
4. The entire block is read row-wise, left to right, starting with the top row.

Refer to the [LogiCORE IP Interleaver/De-interleaver v7.0 Product Specification](#) for examples and more detailed information on the Rectangular Block Interleaver.

## AXI Interface

The AXI SID v7.0 has the following interfaces:

- A non AXI-channel interface for ACLK, ACLKEN and ARESETn
- A non AXI-channel interface for external memory (if enabled)
- A non AXI-channel interface for miscellaneous events
  - ◆ event\_tlast\_unexpected
  - ◆ event\_tlast\_missing (available only in Rectangular mode)
  - ◆ event\_halted (optional, available when Master channel TREADY is enabled)
  - ◆ event\_col\_valid (optional)
  - ◆ event\_col\_sel\_valid (optional)
  - ◆ event\_row\_valid (optional)
  - ◆ event\_row\_sel\_valid (optional)
  - ◆ event\_block\_size\_valid (optional)
- An AXI slave channel to receive configuration information (s\_axis\_ctrl) consisting of:
  - ◆ s\_axis\_ctrl\_tvalid
  - ◆ s\_axis\_ctrl\_tready
  - ◆ s\_axis\_ctrl\_tdata

The control channel is only enabled when the core is configured in such a way to require it.

- An AXI slave channel to receive the data to be interleaved (s\_axis\_data) consisting of:
  - ◆ s\_axis\_data\_tvalid (This is the equivalent of ND pin of SID v6.0 block; No longer optional)
  - ◆ s\_axis\_data\_tready
  - ◆ s\_axis\_data\_tdata
  - ◆ s\_axis\_data\_tlast
- An AXI master channel to send the data that has been interleaved (m\_axis\_data) consisting of:
  - ◆ m\_axis\_data\_tvalid
  - ◆ m\_axis\_data\_tready
  - ◆ m\_axis\_data\_tdata
  - ◆ m\_axis\_data\_tuser
  - ◆ m\_axis\_data\_tlast

## AXI Ports that are Unique to this Block

This SystemGenerator block exposes the AXI Control and Data channels as a group of separate ports based on the following sub-field names.

**Note:** Refer to the [LogiCORE IP Interleaver/De-interleaver v7.0 Product Specification](#) for an explanation of the bits in the specified sub-field name.

## Control Channel Input Signals:

### **s\_axis\_ctrl\_tdata\_config\_sel**

A sub-field port that represents the CONFIG\_SEL field in the Control Channel vector. Available when in Forney mode and Number of configurations is greater than one.

### **s\_axis\_ctrl\_tdata\_row**

A sub-field port that represents the ROW field in the Control Channel vector. Available when in Rectangular mode and Row type is Variable.

### **s\_axis\_ctrl\_tdata\_row\_sel**

A sub-field port that represents the ROW\_SEL field in the Control Channel vector. Available when in Rectangular mode and Row type is Selectable.

### **s\_axis\_ctrl\_tdata\_col**

A sub-field port that represents the COL field in the Control Channel vector. Available when in Rectangular mode and Column type is Variable.

### **s\_axis\_ctrl\_tdata\_col\_sel**

A sub-field port that represents the COL\_SEL field in the Control Channel vector. Available when in Rectangular mode and Column type is Selectable.

### **s\_axis\_ctrl\_tdata\_block\_size**

A sub-field port that represents the COL field in the Control Channel vector. Available when in Rectangular mode and Block Size type is Variable.

## DATA Channel Input Signals:

### **s\_axis\_data\_tdata\_din**

Represents the DIN field of the Input Data Channel.

## DATA Channel Output Signals:

### **m\_axis\_data\_tdata\_dout**

Represents the DOUT field of the Output Data Channel.

## TUSER Channel Output Signals:

### **m\_axis\_data\_tuser\_fdo**

Represents the FDO field of the Output TUSER Channel. Available when in Forney mode and Optional FDO pin has been selected on the GUI.

### **m\_axis\_data\_tuser\_rdy**

Represents the RDY field of the Output TUSER Channel. Available when in Forney mode and Optional RDY pin has been selected on the GUI.

### **m\_axis\_data\_tuser\_block\_start**

Represents the BLOCK\_START field of the Output TUSER Channel. Available when in Rectangular mode and Optional BLOCK\_START pin has been selected on the GUI.

### **m\_axis\_data\_tuser\_block\_end**

Represents the BLOCK\_END field of the Output TUSER Channel. Available when in Rectangular mode and Optional BLOCK\_END pin has been selected on the GUI.

## Block Parameters

The block parameters dialog box can be invoked by double-clicking the icon in your Simulink model.

### Basic Parameters Tab

Parameters specific to the Basic Parameters tab are as follows:

- **Memory Style:** Select **Distributed** if all the Block Memories are required elsewhere in the design; select **Block** to use Block Memory where ever possible; select **Automatic** and let Sysgen use the most appropriate style of memory for each case, based on the required memory depth.
- **Symbol Width:** this is the number of bits in the symbols to be processed.
- **Type:** Select **Forney Convolutional** or **Rectangular Block**.
- **Mode:** Select **Interleaver** or **Deinterleaver**
- **Symbol memory:** Specifies whether or not the data symbols are stored in **Internal** FPGA RAM or in **External** RAM.

### Forney Parameters Tab

Parameters specific to the Forney Parameters tab are as follows:

#### Dimensions

- **Number of branches:** 1 to 256 (inclusive)

#### Architecture

- **ROM-based:** Look-up table ROMs are used to compute some of the internal results in the block
- **Logic-based:** Logic circuits are used to compute some of the internal results in the block

Which option is best depends on the other core parameters. You should try both options to determine the best results. This parameter has no effect on the block behavior.

#### Configurations

- **Number of configurations:** If greater than 1, the block is generated with CONFIG\_SEL and NEW\_CONFIG inputs. The parameters for each configuration are defined in a COE file. The number of parameters defined must exactly match the number of configurations specified.

#### Length of Branches

- Branch length descriptions for Forney SID.
  - ◆ **constant\_difference\_between\_consecutive\_branches:** specified by the **Value** parameter
  - ◆ **use\_coe\_file\_to\_define\_branch\_lengths:** location of file is specified by the **COE File** parameter
  - ◆ **coe\_file\_defines\_individual\_branch\_lengths\_for\_every\_branch\_in\_each\_configuration** : location of file is specified by the **COE File** parameter
  - ◆ **coe\_file\_defines\_branch\_length\_constant\_for\_each\_configuration:** location of file is specified by the **COE File** parameter
- **Value:** 1 to MAX (inclusive). MAX depends on the number of branches and size of block input. Branch length must be an array of either length one or number of branches. If the array size is one, the value is used as a constant difference between consecutive branches. Otherwise, each branch has a unique length.

- **COE File:** The branch lengths are specified from a file

## Rectangular Parameters #1 Tab

Parameters specific to the Rectangular Parameters #1 tab are as follows:

### Number of Rows

- **Value:** This parameter is relevant only when the **Constant** row type is selected. The number of rows is fixed at this value.
- **Row Port Width:** This parameter is relevant only when the **Variable** row type is selected. It sets the width of the ROW input bus. The smallest possible value should be used to keep the underlying LogiCORE as small as possible.
- **Minimum Number of Rows:** This parameter is relevant only when the **Variable** row type is selected. In this case, the core has to potentially cope with a wide range of possible values for the number of rows. If the smallest value that will actually occur is known, then the amount of logic in the LogiCORE can sometimes be reduced. The largest possible value should be used for this parameter to keep the core as small as possible.
- **Number of Values:** This parameter is relevant only when the **Selectable** row type is selected. This parameter defines how many valid selection values have been defined in the COE file. You should only add the number of select values you need.

### Row Type

- **Constant:** The number of rows is always equal to the Row Constant Value parameter.
- **Variable:** The number of rows is sampled from the ROW input at the start of each new block. Row permutations are not supported for the variable row type.
- **Selectable:** ROW\_SEL is sampled at the start of each new block. This value is then used to select from one of the possible values for the number of rows provided in the COE file.

### Number of Columns

- **Value:** This parameter is relevant only when the **Constant** column type is selected. The number of columns is fixed at this value.
- **COL Port Width:** This parameter is relevant only when the **Variable** column type is selected. It sets the width of the COL input bus. The smallest possible value should be used to keep the underlying LogiCORE as small as possible.
- **Minimum Number of Columns:** This parameter is relevant only when the **Variable** column type is selected. In this case, the core has to potentially cope with a wide range of possible values for the number of columns. If the smallest value that will actually occur is known, then the amount of logic in the LogiCORE can sometimes be reduced. The largest possible value should be used for this parameter to keep the core as small as possible.
- **Number of Values:** This parameter is relevant only when the **Selectable** column type is selected. This parameter defines how many valid selection values have been defined in the COE file. You should only add the number of select values you need.

### Column Type

- **Constant:** The number of columns is always equal to the Column Constant Value parameter.
- **Variable:** The number of columns is sampled from the COL input at the start of each new block. Column permutations are not supported for the variable column type.
- **Selectable:** COL\_SEL is sampled at the start of each new block. This value is then used to select from one of the possible values for the number of columns provided in the COE file.



## Rectangular Parameters #2 Tab

Parameters specific to the Rectangular Parameters #2 tab are as follows:

### Permutations Configuration

#### Row permutations:

- ◆ **None:** This tells System Generator that row permutations are not to be performed
- ◆ **Use COE file:** This tells System Generator that a row permute vector exists in the COE file, and that row permutations are to be performed. Remember this is possible only for unpruned interleaver/deinterleavers.

#### Column permutations:

- ◆ **None:** This tells System Generator that column permutations are not to be performed
- ◆ **Use COE file:** This tells System Generator that a column permute vector exists in the COE file, and that column permutations are to be performed. Remember this is possible only for unpruned interleaver/deinterleavers.

**COE File:** Specify the pathname to the COE file.

### Block Size

- **Value:** This parameter is relevant only when the **Constant** block size type is selected. The block size is fixed at this value.
- **BLOCK\_SIZE Port Width:** This parameter is relevant only if the **Variable** block size type is selected. It sets the width of the BLOCK\_SIZE input bus. The smallest possible value should be used to keep the core as small as possible.

### Block Size Type

- **Constant:** The block size never changes. The block can be pruned (block size < row \* col). The block size must be chosen so that the last symbol is on the last row. An unpruned interleaver will use a smaller quantity of FPGA resources than a pruned one, so pruning should be used only if necessary.
- **Rows\*Columns:** If the number of rows and columns is constant, selecting this option has the same effect as setting the block size type to constant and entering a value of rows \* columns for the block size.

If the number of rows or columns is not constant, selecting this option means the core will calculate the block size automatically whenever a new row or column value is sampled. Pruning is impossible with this block size type.

- **Variable:** Block size is sampled from the BLOCK\_SIZE input at the beginning of every block. The value sampled on BLOCK\_SIZE must be such that the last symbol falls on the last row, as previously described.

If the block size is already available external to the core, selecting this option is usually more efficient than selecting “rows \* columns” for the block size type. Row and column permutations are not supported for the **Variable** block size type.

## Port Parameters #1 tab

Parameters specific to the Port Parameters tab are as follows:

### Control Signals

- **ACLKEN:** When ACLKEN is deasserted (Low), all the synchronous inputs are ignored and the block remains in its current state.

- **ARESETn (Active Low):** Active-low synchronous clear input that always takes priority over ACLKEN.

#### Status Signals

- **COL\_VALID:** This optional output is available when a variable number of columns is selected. If an illegal value is sampled on the `s_axis_ctrl_tdata_col` input, `event_col_valid` will go Low a predefined number of clock cycles later.
- **COL\_SEL\_VALID:** This optional output (`event_col_sel_valid`) is available when a selectable number of columns is chosen. The event pins are `event_col_valid`, `event_col_sel_valid`, `event_row_valid`, `event_row_sel_valid`, `event_block_size_valid` (in the same order as in the options on the GUI).
- **ROW\_VALID:** This optional output is available when a selectable number of rows is chosen.
- **ROW\_SEL\_VALID:** This optional output is available when a selectable number of rows is chosen.
- **BLOCK\_SIZE\_VALID:** This optional output is available when the block size is not constant, that is, if the block size type is either **Variable** or equal to **Rows \* Columns**.

#### Port Parameters #2 tab

Parameters specific to the Port Parameters #2 tab are as follows:

##### Data Output Channel Options

- **TREADY:** TREADY for the Data Input Channel. Used by the Symbol Interleaver/De-interleaver to signal that it is ready to accept data.
- **FDO:** Adds a `data_tuser_fdo` (First Data Out) output port.
- **RDY:** Adds a `data_tuser_rdy` output port.
- **BLOCK\_START:** Adds a `data_tuser_block_start` output port.
- **BLOCK\_END:** Adds a `data_tuser_block_end` output port.

##### Pipelining

- **Pipelining:** Pipelines the underlying LogiCORE for **Minimum**, **Medium**, or **Maximum** performance

Other parameters used by this block are explained in the topic [Common Options in Block Parameter Dialog Boxes](#).

## LogiCORE™ Documentation

[LogiCORE IP Interleaver/De-interleaver v7.0](#)

## Device Support

Virtex-7, Kintex-7, Artix-7, Zynq-7000, Virtex-6, Spartan-6

# Interleaver/De-interleaver 7.1

This block is listed in the following Xilinx Blockset libraries: AXI, Communication and Index.

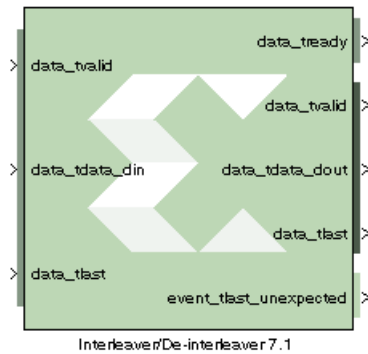

The Xilinx Interleaver Deinterleaver block implements an interleaver or a deinterleaver using an AXI4-compliant block interface. An interleaver is a device that rearranges the order of a sequence of input symbols. The term symbol is used to describe a collection of bits. In some applications, a symbol is a single bit. In others, a symbol is a bus.

The classic use of interleaving is to randomize the location of errors introduced in signal transmission. Interleaving spreads a burst of errors out so that error correction circuits have a better chance of correcting the data.

If a particular interleaver is used at the transmit end of a channel, the inverse of that interleaver must be used at the receive end to recover the original data. The inverse interleaver is referred to as a de-interleaver.

Two types of interleaver/de-interleavers can be generated with this LogiCORE: Forney Convolutional and Rectangular Block. Although they both perform the general interleaving function of rearranging symbols, the way in which the symbols are rearranged and their methods of operation are entirely different. For very large interleavers, it might be preferable to store the data symbols in external memory. The core provides an option to store data symbols in internal FPGA RAM or in external RAM.

## Forney Convolutional Operation

In the figure below, shows the operation of a Forney Convolutional Interleaver. The core operates as a series of delay line shift registers. Input symbols are presented to the input commutator arm on DIN. Output symbols are extracted from the output commutator arm on DOUT. DIN and DOUT are fields in the AXI Data Input and Data Output channels, respectively. Output symbols are extracted from the output commutator arm on DOUT. Both commutator arms start at branch 0 and advance to the next branch after the next rising clock edge. After the last branch (B-1) has been reached, the commutator arms both rotate back to branch 0 and the process is repeated.

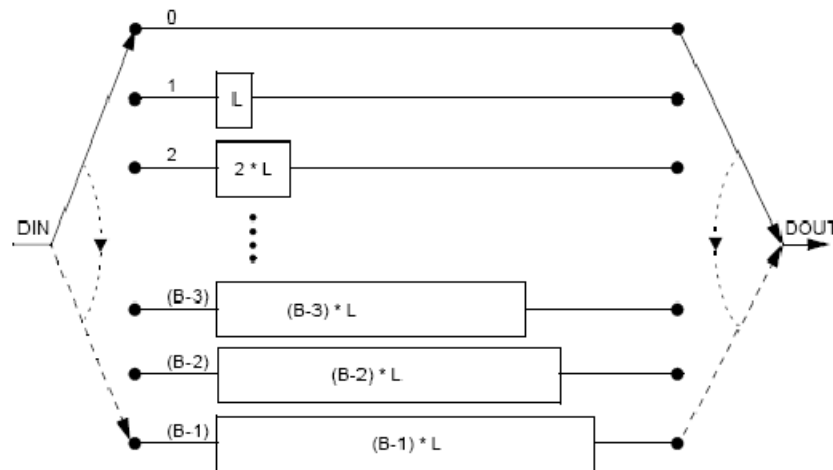

In the figure above, the branches increase in length by a uniform amount, L. The core allows interleavers to be specified in this way, or the branch lengths can be passed in using a file, allowing each branch to be any length.

Although branch 0 appears to be a zero-delay connection, there will still be a delay of a number of clock cycles between DIN and DOUT because of the fundamental latency of the core. For clarity, this is not illustrated in the figure.

The only difference between an interleaver and a de-interleaver is that branch 0 is the longest in the deinterleaver and the branch length is decremented by  $L$  rather than incremented. Branch  $(B-1)$  has length 0. This is illustrated in the figure below:

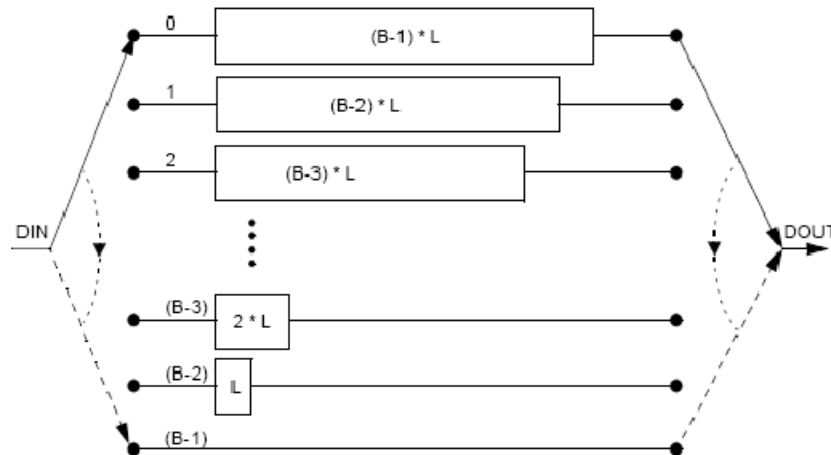

If a file is used to specify the branch lengths, as shown below, it is arbitrary whether the resulting core is called an interleaver or de-interleaver. All that matters is that one must be the inverse of the other. If a file is used, each branch length is individually controllable. This is illustrated in the figure below. For the file syntax, please consult the LogiCORE product specification.

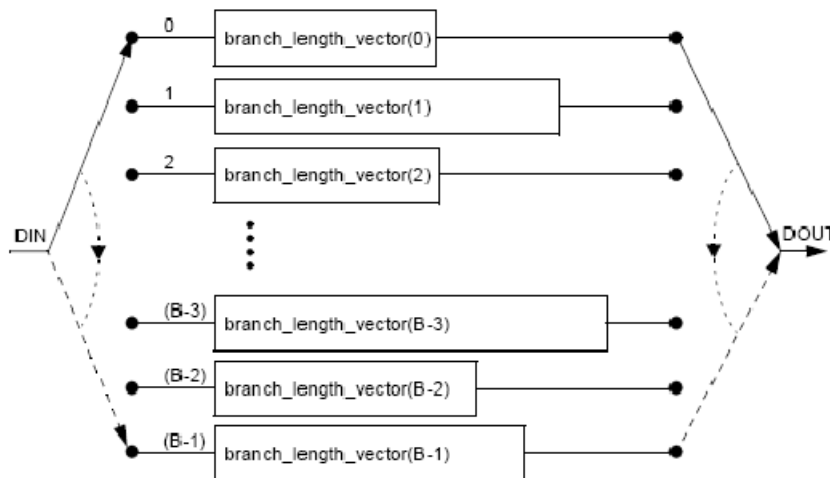

The reset pin (`aresetn`) sets the commutator arms to branch 0, but does not clear the branches of data.

## Configuration Swapping

It is possible for the core to store a number of pre-defined configurations. Each configuration can have a different number of branches and branch length constant. It is even possible for each configuration to have every individual branch length defined by file.

The configuration can be changed at any time by sending a new CONFIG\_SEL value on the AXI Control Channel. This value takes effect when the next block starts. The core assumes all configurations are either for an interleaver or de-interleaver, depending on what was selected in the GUI. It is possible to switch between interleaving and de-interleaving by defining the individual branch lengths for every branch of each configuration. The details for each configuration are specified in a COE file.

For details, please consult the Configuration Swapping section of the [LogiCORE IP Interleaver/De-interleaver v7.1 Product Guide](#).

## Rectangular Block Operation

The Rectangular Block Interleaver works by writing the input data symbols into a rectangular memory array in a certain order and then reading them out in a different, mixed-up order. The input symbols must be grouped into blocks. Unlike the Convolutional Interleaver, where symbols can be continuously input, the Rectangular Block Interleaver inputs one block of symbols and then outputs that same block with the symbols rearranged. No new inputs can be accepted while the interleaved symbols from the previous block are being output.

The rectangular memory array is composed of a number of rows and columns as shown in the following figure.

Row\Column	0	1	...	(C-2)	(C-1)
0					
1					
.					
.					
(R-2)					
(R-1)					

The Rectangular Block Interleaver operates as follows:

1. All the input symbols in an entire block are written row-wise, left to right, starting with the top row.
2. Inter-row permutations are performed if required.
3. Inter-column permutations are performed if required.
4. The entire block is read column-wise, top to bottom, starting with the left column.

The Rectangular Block De-interleaver operates in the reverse way:

1. All the input symbols in an entire block are written column-wise, top to bottom, starting with the left column.
2. Inter-row permutations are performed if required.
3. Inter-column permutations are performed if required.
4. The entire block is read row-wise, left to right, starting with the top row.

Refer to the [LogiCORE IP Interleaver/De-interleaver v7.1 Product Guide](#) for examples and more detailed information on the Rectangular Block Interleaver.

## AXI Interface

The AXI SID v7.1 has the following interfaces:

- A non AXI-channel interface for ACLK, ACLKEN and ARESETn
- A non AXI-channel interface for external memory (if enabled)
- A non AXI-channel interface for miscellaneous events
  - ◆ event\_tlast\_unexpected
  - ◆ event\_tlast\_missing (available only in Rectangular mode)
  - ◆ event\_halted (optional, available when Master channel TREADY is enabled)
  - ◆ event\_col\_valid (optional)
  - ◆ event\_col\_sel\_valid (optional)
  - ◆ event\_row\_valid (optional)
  - ◆ event\_row\_sel\_valid (optional)
  - ◆ event\_block\_size\_valid (optional)
- An AXI slave channel to receive configuration information (s\_axis\_ctrl) consisting of:
  - ◆ s\_axis\_ctrl\_tvalid
  - ◆ s\_axis\_ctrl\_tready
  - ◆ s\_axis\_ctrl\_tdata

The control channel is only enabled when the core is configured in such a way to require it.

- An AXI slave channel to receive the data to be interleaved (s\_axis\_data) consisting of:
  - ◆ s\_axis\_data\_tvalid (This is the equivalent of ND pin of SID v6.0 block; No longer optional)
  - ◆ s\_axis\_data\_tready
  - ◆ s\_axis\_data\_tdata
  - ◆ s\_axis\_data\_tlast
- An AXI master channel to send the data that has been interleaved (m\_axis\_data) consisting of:
  - ◆ m\_axis\_data\_tvalid
  - ◆ m\_axis\_data\_tready
  - ◆ m\_axis\_data\_tdata
  - ◆ m\_axis\_data\_tuser
  - ◆ m\_axis\_data\_tlast

## AXI Ports that are Unique to this Block

This SystemGenerator block exposes the AXI Control and Data channels as a group of separate ports based on the following sub-field names.

**Note:** Refer to the Interleaver/De-Interleaver v7.1 Product Specification for an explanation of the bits in the specified sub-field name.

### Control Channel Input Signals:

**s\_axis\_ctrl\_tdata\_config\_sel**

A sub-field port that represents the CONFIG\_SEL field in the Control Channel vector. Available when in Forney mode and Number of configurations is greater than one.

**s\_axis\_ctrl\_tdata\_row**

A sub-field port that represents the ROW field in the Control Channel vector. Available when in Rectangular mode and Row type is Variable.

**s\_axis\_ctrl\_tdata\_row\_sel**

A sub-field port that represents the ROW\_SEL field in the Control Channel vector. Available when in Rectangular mode and Row type is Selectable.

**s\_axis\_ctrl\_tdata\_col**

A sub-field port that represents the COL field in the Control Channel vector. Available when in Rectangular mode and Column type is Variable.

**s\_axis\_ctrl\_tdata\_col\_sel**

A sub-field port that represents the COL\_SEL field in the Control Channel vector. Available when in Rectangular mode and Column type is Selectable.

**s\_axis\_ctrl\_tdata\_block\_size**

A sub-field port that represents the COL field in the Control Channel vector. Available when in Rectangular mode and Block Size type is Variable.

### DATA Channel Input Signals:

**s\_axis\_data\_tdata\_din**

Represents the DIN field of the Input Data Channel.

### DATA Channel Output Signals:

**m\_axis\_data\_tdata\_dout**

Represents the DOUT field of the Output Data Channel.

### TUSER Channel Output Signals:

**m\_axis\_data\_tuser\_fdo**

Represents the FDO field of the Output TUSER Channel. Available when in Forney mode and Optional FDO pin has been selected on the GUI.

**m\_axis\_data\_tuser\_rdy**

Represents the RDY field of the Output TUSER Channel. Available when in Forney mode and Optional RDY pin has been selected on the GUI.

**m\_axis\_data\_tuser\_block\_start**

Represents the BLOCK\_START field of the Output TUSER Channel. Available when in Rectangular mode and Optional BLOCK\_START pin has been selected on the GUI.

**m\_axis\_data\_tuser\_block\_end**

Represents the BLOCK\_END field of the Output TUSER Channel. Available when in Rectangular mode and Optional BLOCK\_END pin has been selected on the GUI.

## Block Parameters

The block parameters dialog box can be invoked by double-clicking the icon in your Simulink model.

### Basic Parameters Tab

Parameters specific to the Basic Parameters tab are as follows:

- **Memory Style:** Select **Distributed** if all the Block Memories are required elsewhere in the design; select **Block** to use Block Memory where ever possible; select **Automatic** and let Sysgen use the most appropriate style of memory for each case, based on the required memory depth.
- **Symbol Width:** this is the number of bits in the symbols to be processed.
- **Type:** Select **Forney Convolutional** or **Rectangular Block**.
- **Mode:** Select **Interleaver** or **Deinterleaver**
- **Symbol memory:** Specifies whether or not the data symbols are stored in **Internal** FPGA RAM or in **External** RAM.

### Forney Parameters Tab

Parameters specific to the Forney Parameters tab are as follows:

#### Dimensions

- **Number of branches:** 1 to 256 (inclusive)

#### Architecture

- **ROM-based:** Look-up table ROMs are used to compute some of the internal results in the block
- **Logic-based:** Logic circuits are used to compute some of the internal results in the block

Which option is best depends on the other core parameters. You should try both options to determine the best results. This parameter has no effect on the block behavior.

#### Configurations

- **Number of configurations:** If greater than 1, the block is generated with CONFIG\_SEL and NEW\_CONFIG inputs. The parameters for each configuration are defined in a COE file. The number of parameters defined must exactly match the number of configurations specified.

#### Length of Branches

- Branch length descriptions for Forney SID.
  - ◆ **constant\_difference\_between\_consecutive\_branches:** specified by the **Value** parameter
  - ◆ **use\_coe\_file\_to\_define\_branch\_lengths:** location of file is specified by the **COE File** parameter
  - ◆ **coe\_file\_defines\_individual\_branch\_lengths\_for\_every\_branch\_in\_each\_configuration** : location of file is specified by the **COE File** parameter
  - ◆ **coe\_file\_defines\_branch\_length\_constant\_for\_each\_configuration:** location of file is specified by the **COE File** parameter
- **Value:** 1 to MAX (inclusive). MAX depends on the number of branches and size of block input. Branch length must be an array of either length one or number of branches. If the array size is one, the value is used as a constant difference between consecutive branches. Otherwise, each branch has a unique length.



- **COE File:** The branch lengths are specified from a file

## Rectangular Parameters #1 Tab

Parameters specific to the Rectangular Parameters #1 tab are as follows:

### Number of Rows

- **Value:** This parameter is relevant only when the **Constant** row type is selected. The number of rows is fixed at this value.
- **Row Port Width:** This parameter is relevant only when the **Variable** row type is selected. It sets the width of the ROW input bus. The smallest possible value should be used to keep the underlying LogiCORE as small as possible.
- **Minimum Number of Rows:** This parameter is relevant only when the **Variable** row type is selected. In this case, the core has to potentially cope with a wide range of possible values for the number of rows. If the smallest value that will actually occur is known, then the amount of logic in the LogiCORE can sometimes be reduced. The largest possible value should be used for this parameter to keep the core as small as possible.
- **Number of Values:** This parameter is relevant only when the **Selectable** row type is selected. This parameter defines how many valid selection values have been defined in the COE file. You should only add the number of select values you need.

### Row Type

- **Constant:** The number of rows is always equal to the Row Constant Value parameter.
- **Variable:** The number of rows is sampled from the ROW input at the start of each new block. Row permutations are not supported for the variable row type.
- **Selectable:** ROW\_SEL is sampled at the start of each new block. This value is then used to select from one of the possible values for the number of rows provided in the COE file.

### Number of Columns

- **Value:** This parameter is relevant only when the **Constant** column type is selected. The number of columns is fixed at this value.
- **COL Port Width:** This parameter is relevant only when the **Variable** column type is selected. It sets the width of the COL input bus. The smallest possible value should be used to keep the underlying LogiCORE as small as possible.
- **Minimum Number of Columns:** This parameter is relevant only when the **Variable** column type is selected. In this case, the core has to potentially cope with a wide range of possible values for the number of columns. If the smallest value that will actually occur is known, then the amount of logic in the LogiCORE can sometimes be reduced. The largest possible value should be used for this parameter to keep the core as small as possible.
- **Number of Values:** This parameter is relevant only when the **Selectable** column type is selected. This parameter defines how many valid selection values have been defined in the COE file. You should only add the number of select values you need.

### Column Type

- **Constant:** The number of columns is always equal to the Column Constant Value parameter.
- **Variable:** The number of columns is sampled from the COL input at the start of each new block. Column permutations are not supported for the variable column type.
- **Selectable:** COL\_SEL is sampled at the start of each new block. This value is then used to select from one of the possible values for the number of columns provided in the COE file.

## Rectangular Parameters #2 Tab

Parameters specific to the Rectangular Parameters #2 tab are as follows:

Permutations Configuration

### Row permutations:

- ◆ **None:** This tells System Generator that row permutations are not to be performed
- ◆ **Use COE file:** This tells System Generator that a row permute vector exists in the COE file, and that row permutations are to be performed. Remember this is possible only for unpruned interleaver/deinterleavers.

### Column permutations:

- ◆ **None:** This tells System Generator that column permutations are not to be performed
- ◆ **Use COE file:** This tells System Generator that a column permute vector exists in the COE file, and that column permutations are to be performed. Remember this is possible only for unpruned interleaver/deinterleavers.

**COE File:** Specify the pathname to the COE file.

Block Size

- **Value:** This parameter is relevant only when the **Constant** block size type is selected. The block size is fixed at this value.
- **BLOCK\_SIZE Port Width:** This parameter is relevant only if the **Variable** block size type is selected. It sets the width of the BLOCK\_SIZE input bus. The smallest possible value should be used to keep the core as small as possible.

Block Size Type

- **Constant:** The block size never changes. The block can be pruned (block size < row \* col). The block size must be chosen so that the last symbol is on the last row. An unpruned interleaver will use a smaller quantity of FPGA resources than a pruned one, so pruning should be used only if necessary.
- **Rows\*Columns:** If the number of rows and columns is constant, selecting this option has the same effect as setting the block size type to constant and entering a value of rows \* columns for the block size.

If the number of rows or columns is not constant, selecting this option means the core will calculate the block size automatically whenever a new row or column value is sampled. Pruning is impossible with this block size type.

- **Variable:** Block size is sampled from the BLOCK\_SIZE input at the beginning of every block. The value sampled on BLOCK\_SIZE must be such that the last symbol falls on the last row, as previously described.

If the block size is already available external to the core, selecting this option is usually more efficient than selecting “rows \* columns” for the block size type. Row and column permutations are not supported for the **Variable** block size type.

## Port Parameters #1 tab

Parameters specific to the Port Parameters tab are as follows:

Control Signals

- **ACLKEN:** When ACLKEN is deasserted (Low), all the synchronous inputs are ignored and the block remains in its current state.

- **ARESETn (Active Low):** Active-low synchronous clear input that always takes priority over ACLKEN.

#### Status Signals

- **COL\_VALID:** This optional output is available when a variable number of columns is selected. If an illegal value is sampled on the `s_axis_ctrl_tdata_col` input, `event_col_valid` will go Low a predefined number of clock cycles later.
- **COL\_SEL\_VALID:** This optional output (`event_col_sel_valid`) is available when a selectable number of columns is chosen. The event pins are `event_col_valid`, `event_col_sel_valid`, `event_row_valid`, `event_row_sel_valid`, `event_block_size_valid` (in the same order as in the options on the GUI).
- **ROW\_VALID:** This optional output is available when a selectable number of rows is chosen.
- **ROW\_SEL\_VALID:** This optional output is available when a selectable number of rows is chosen.
- **BLOCK\_SIZE\_VALID:** This optional output is available when the block size is not constant, that is, if the block size type is either **Variable** or equal to **Rows \* Columns**.

#### Port Parameters #2 tab

Parameters specific to the Port Parameters #2 tab are as follows:

##### Data Output Channel Options

- **TREADY:** TREADY for the Data Input Channel. Used by the Symbol Interleaver/De-interleaver to signal that it is ready to accept data.
- **FDO:** Adds a `data_tuser_fdo` (First Data Out) output port.
- **RDY:** Adds a `data_tuser_rdy` output port.
- **BLOCK\_START:** Adds a `data_tuser_block_start` output port.
- **BLOCK\_END:** Adds a `data_tuser_block_end` output port.

##### Pipelining

- **Pipelining:** Pipelines the underlying LogiCORE for **Minimum**, **Medium**, or **Maximum** performance

Other parameters used by this block are explained in the topic [Common Options in Block Parameter Dialog Boxes](#).

## LogiCORE™ Documentation

[LogiCORE IP Interleaver/De-interleaver v7.1](#)

## Device Support

Virtex-7, Kintex-7, Artix-7

## Inverter

*This block is listed in the following Xilinx Blockset libraries: Basic Elements, Control Logic, Math, and Index.*

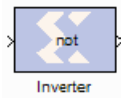

The Xilinx Inverter block calculates the bitwise logical complement of a fixed-point number. The block is implemented as a synthesizable VHDL module.

### Block Parameters

The block parameters dialog box can be invoked by double-clicking the icon in your Simulink model.

Other parameters used by this block are explained in the topic [Common Options in Block Parameter Dialog Boxes](#).

## JTAG Co-Simulation

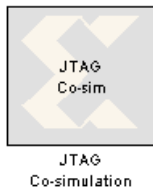

The Xilinx JTAG Co-Simulation block allows you to perform hardware co-simulation using JTAG and a Parallel Cable IV or Platform USB. The JTAG hardware co-simulation interface takes advantage of the ubiquity of JTAG to extend System Generator's hardware in the simulation loop capability to numerous other FPGA platforms.

The port interface of the co-simulation block varies. When a model is implemented for JTAG hardware co-simulation, a new library is created that contains a custom JTAG co-simulation block with ports that match the gateway names (or port names if the subsystem is not the top level) from the original model. The co-simulation block interacts with the FPGA hardware platform during a Simulink simulation. Simulation data that is written to the input ports of the block are passed to the hardware by the block. Conversely, when data is read from the co-simulation block's output ports, the block reads the appropriate values from the hardware and drives them on the output ports so they can be interpreted in Simulink. In addition, the block automatically opens, configures, steps, and closes the platform.

Refer to [JTAG Hardware Co-Simulation](#) for JTAG hardware requirements, and information on how to support new platforms.

### Block Parameters

The block parameters dialog box can be invoked by double-clicking the icon in your Simulink model.

#### Basic tab

Parameters specific to the Basic tab are as follows:

- **Clock source:** You can select between Single stepped and Free running clock sources. Selecting a Single stepped clock allows the block to step the board one clock cycle at a time. Each clock cycle step corresponds to some duration of time in Simulink. Using this clock source ensures the behavior of the co-simulation hardware during simulation is bit and cycle accurate when compared to the simulation behavior of the subsystem from which it originated. Sometimes single stepping is not necessary and the board can be run with a Free Running clock. In this case, the board will operate asynchronously to the Simulink simulation.
- **Has combinational path:** Sometimes it is necessary to have a direct combinational feedback path from an output port on a hardware co-simulation block to an input port on the same block (e.g., a wire connecting an output port to an input port on a given block). If you require a direct feedback path from an output to input port, and your design does not include a combinational path from any input port to any output port, un-checking this box will allow the feedback path in the design.
- **Bitstream name:** Specifies the co-simulation FPGA configuration file for the JTAG hardware co-simulation platform. When a new co-simulation block is created during compilation, this parameter is automatically set so that it points to the appropriate configuration file. You need only adjust this parameter if the location of the configuration file changes.

#### Advanced tab

- **Skip device configuration:** Selecting this option causes the co-simulation block to skip the device configuration phase at the beginning of a simulation. Doing so is useful for co-simulation designs that do not need to be reset (or reprogrammed) at the end of a simulation.

This checkbox should be used with caution since the co-simulation platform is not programmed when this checkbox is selected. This means that it is possible to perform hardware co-simulation without a co-simulation bitstream loaded on the hardware platform.

## Cable tab

- **Type** Select one of the following: **Auto Detect**, **Xilinx Parallel Cable IV**, **Xilinx Platform USB**, **Xilinx Point-to-point Ethernet**, **Custom**. When **Auto Detect** is selected, JTAG co-simulation automatically scans through different JTAG cables (LPT1-LPT4, USB21-USB216) and picks the first FPGA device that matches what the design is targeted for.
- Similarly, you can select **Xilinx Parallel Cable IV**, **Xilinx Platform USB**, or **Custom** to use the different JTAG configuration cables.
- **Speed**: Sometimes you might need to run the programming cable at a frequency less than the default (maximum) speed setting for hardware co-simulation. This menu allows you to choose a cable speed that is suitable for your hardware setup. Normally the default speed will suffice, however, it is recommended to try a slower cable speed if System Generator fails to configure the device for co-simulation.
- **Port** Select the port name for the JTAG cable.
- **Blink Cable LED** When Xilinx Platform USB is selected, you can click on this button to activate a blinking light next to the cable connector on the hardware board.
- **Plug-in Parameters** Specify the plug-in parameters for a **Custom** cable. This field uses the same syntax as that used by ChipScope/iMPACT.

<plugin> <param1>=<value1> <param2>=<value2>

For example, see the figure below:

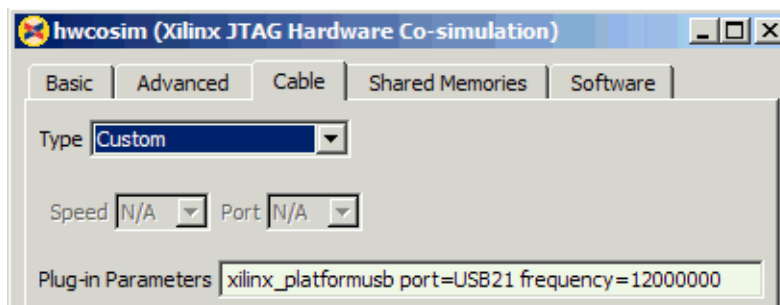

Refer to the Chipscope/iMPACT user documentation for further details on the cable plugin parameters.

- **Shared cable for concurrent access**: This option allows the JTAG cable to be shared with EDK XMD and ChipScope™ Pro Analyzer during a JTAG co-simulation. When the option is checked, the JTAG co-simulation engine only acquires a lock on the cable access and then immediately releases the lock when the access completes. Otherwise, the JTAG co-simulation engine holds the lock throughout the simulation. Due to the significant overhead on locking and unlocking the cable, this cable sharing option is disabled by default and only enabled when you check the box.

## Shared Memories tab

Displays the names of the shared memories that are detected in the design to be simulated.

## Software tab

Parameters specific to the Network tab are as follows:

- **Enable Co-Debug with Xilinx SDK:** On by default, clicking this item off disables the SDK Co-Debug feature in Sysgen

### Xilinx Software Development Kit (SDK)

- **Workspace:** Specifies the pathname to the SDK workspace when SDK is started from Sysgen using the Launch Xilinx SDK button.
- **Launch Xilinx SDK:** Starts Xilinx SDK for use in a Sysgen/SDK Co-Debug session

### Software Initialization

- **ELF file:** Specifies the pathname to the SDK project ELF file.
- **BMM file:** Specifies the pathname to the SDK project BMM file.

Other parameters used by this block are explained in the topic [Common Options in Block Parameter Dialog Boxes](#).

## LFSR

This block is listed in the following Xilinx Blockset libraries: Basic Elements, DSP, Memory, and Index.

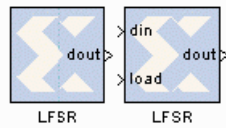

The Xilinx LFSR block implements a Linear Feedback Shift Register (LFSR). This block supports both the Galois and Fibonacci structures using either the XOR or XNOR gate and allows a re-loadable input to change the current value of the register at any time. The LFSR output and re-loadable input can be configured as either serial or parallel ports

### Block Interface

Port Name	Port Description	Port Type
din	Data input for re-loadable seed	Optional serial or parallel input
load	Load signal for din	Optional boolean input
rst	Reset signal	Optional boolean input
en	Enable signal	Optional boolean input
dout	Data output of LFSR	Required serial or parallel output

As shown in the table above, there can be between 0 and 4 block input ports and exactly one output port. If the configuration selected requires 0 inputs, the LFSR is set up to start at a specified initial seed value and will step through a repeatable sequence of states determined by the LFSR structure type, gate type and initial seed.

The optional `din` and `load` ports provide the ability to change the current value of the LFSR at runtime. After the load completes, the LFSR behaves as with the 0 input case and start up a new sequence based upon the newly loaded seed and the statically configured LFSR options for structure and gate type.

The optional `rst` port will reload the statically specified initial seed of the LFSR and continue on as before after the `rst` signal goes low. And when the optional `en` port goes low, the LFSR will remain at its current value with no change until the `en` port goes high again.

### Block Parameters

The block parameters dialog box can be invoked by double-clicking the icon in your Simulink model.

#### Basic tab

Parameters specific to the Basic tab are as follows:

- **Type:** Fibonacci or Galois. This field specifies the structure of the feedback. Fibonacci has one XOR (or XNOR) gate at the beginning of the register chain that XORs (or XNORs) the taps together with the result going into the first register. Galois has one XOR(or XNOR) gate for each tap and gates the last register in the chains output with the input to the register at that tap.
- **Gate type:** XOR or XNOR. This field specifies the gate used by the feedback signals.
- **Number of bits in LFSR:** This field specifies the number of registers in the LFSR chain. As a result, this number specifies the size of the input and output when selected to be parallel.



- **Feedback polynomial:** This field specifies the tap points of the feedback chain and the value must be entered in hex with single quotes. The lsb of this polynomial always must be set to 1 and the msb is an implied 1 and is not specified in the hex input. Please see the Xilinx application note titled [Efficient Shift Registers, LFSR Counters, and Long Pseudo- Random Sequence Generators](#) for more information on how to specify this equation and for optimal settings for the maximum repeating sequence.
- **Initial value:** This field specifies the initial seed value where the LFSR begins its repeating sequence. The initial value might not be all zeroes when choosing the XOR gate type and might not be all ones when choosing XNOR, as those values will stall the LFSR.

### Advanced tab

Parameters specific to the Advanced tab are as follows:

- **Parallel output:** This field specifies whether all of the bits in the LFSR chain are connected to the output or just the last register in the chain (serial or parallel).
- **Use reloadable seed values:** This field specifies whether or not an input is needed to reload a dynamic LFSR seed value at runtime.
- **Parallel input:** This field specifies whether the reloadable input seed is shifted in one bit at a time or if it happens in parallel.

Other parameters used by this block are explained in the topic [Common Options in Block Parameter Dialog Boxes](#).

## Logical

This block is listed in the following Xilinx Blockset libraries: *Basic Elements, Control Logic, Math, and Index.*

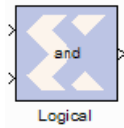

The Xilinx Logical block performs bitwise logical operations on fixed-point numbers. Operands are zero padded and sign extended as necessary to make binary point positions coincide; then the logical operation is performed and the result is delivered at the output port.

In hardware this block is implemented as synthesizable VHDL. If you build a tree of logical gates, this synthesizable implementation is best as it facilitates logic collapsing in synthesis and mapping.

### Block Parameters

The block parameters dialog box can be invoked by double-clicking the icon in your Simulink model.

#### Basic tab

Parameters specific to the Basic tab are as follows:

- **Logical function:** specifies one of the following bitwise logical operators: AND, NAND, OR, NOR, XOR, XNOR.
- **Number of inputs:** specifies the number of inputs (2 - 1024).

#### Output Type tab

Parameters specific to the Output Type tab are as follows:

- **Align binary point:** specifies that the block must align binary points automatically. If not selected, all inputs must have the same binary point position.

Other parameters used by this block are explained in the topic [Common Options in Block Parameter Dialog Boxes](#).

### Xilinx LogiCORE

This block does not use a Xilinx LogiCORE™.

## MCode

This block is listed in the following Xilinx Blockset libraries: *Control Logic, Math, and Index.*

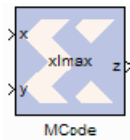

The Xilinx **MCode** block is a container for executing a user-supplied MATLAB function within Simulink. A parameter on the block specifies the M-function name. The block executes the M-code to calculate block outputs during a Simulink simulation. The same code is translated in a straightforward way into equivalent behavioral VHDL/Verilog when hardware is generated.

The block's Simulink interface is derived from the MATLAB function signature, and from block mask parameters. There is one input port for each parameter to the function, and one output port for each value the function returns. Port names and ordering correspond to the names and ordering of parameters and return values.

The **MCode** block supports a limited subset of the MATLAB language that is useful for implementing arithmetic functions, finite state machines and control logic.

The **MCode** block has the following three primary coding guidelines that must be followed:

- All block inputs and outputs must be of Xilinx fixed-point type.
- The block must have at least one output port.
- The code for the block must exist on the MATLAB path or in the same directory as the directory as the model that uses the block.

The topic [Compiling MATLAB into an FPGA](#) shows three examples of functions for the **MCode** block. The first example (also described below) consists of a function `x1max` which returns the maximum of its inputs. The second illustrates how to do simple arithmetic. The third shows how to build a finite state machine. These examples are linked from the topic titled [Additional Examples and Tutorials](#).

### Configuring an MCode Block

The **MATLAB Function** parameter of an **MCode** block specifies the name of the block's M-code function. This function must exist in one of the three locations at the time this parameter is set. The three possible locations are:

- The directory where the model file is located.
- A subdirectory of the model directory named `private`.
- A directory in the MATLAB path.

The block icon displays the name of the M-function. To illustrate these ideas, consider the file `x1max.m` containing function `x1max`:

```
function z = x1max(x, y)
    if x > y
        z = x;
    else
        z = y;
    end
```

An **MCode** block based on the function `x1max` will have input ports `x` and `y` and output port `z`.

The following figure shows how to set up an **MCode** block to use function `xlmax`.

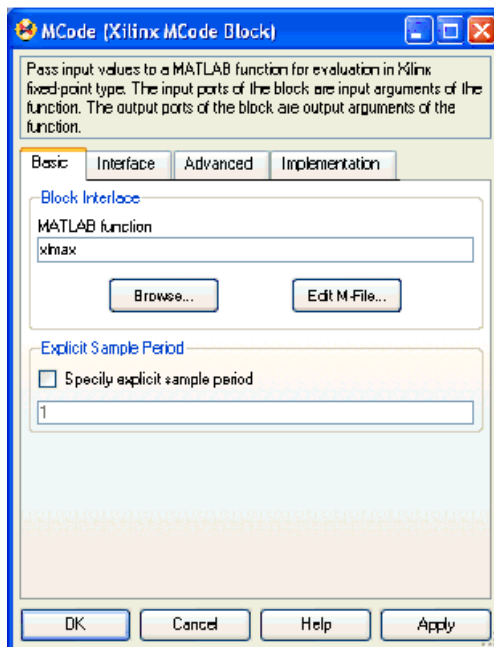

Once the model is compiled, the `xlmax` **MCode** block will appear like the block illustrated below.

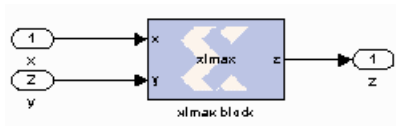

## MATLAB Language Support

The **MCode** block supports the following MATLAB language constructs:

- Assignment statements
- Simple and compound `if/else/elseif` end statements
- `switch` statements
- Arithmetic expressions involving only addition and subtraction
- Addition
- Subtraction
- Multiplication
- Division by a power of two

- Relational operators:

<	Less than
<=	Less than or equal to
>	Greater than
>=	Greater than or equal to
==	Equal to
~=	Not equal to

- Logical operators:

&	And
	Or
~	Not

The **MCode** block supports the following MATLAB functions.

- Type conversion. The only supported data type is `xfix`, the Xilinx fixed-point type. The `xfix()` type conversion function is used to convert to this type. The conversion is done implicitly for integers but must be done explicitly for floating point constants. All values must be scalar; arrays are not supported.

- Functions that return `xfix` properties:

<code>xl_nbits()</code>	Returns number of bits
<code>xl_binpt()</code>	Returns binary point position
<code>xl_arith()</code>	Returns arithmetic type

- Bit-wise logical functions:

<code>xl_and()</code>	Bit-wise and
<code>xl_or()</code>	Bit-wise or
<code>xl_xor()</code>	Bit-wise xor
<code>xl_not()</code>	Bit-wise not

- Shift functions: `xl_lsh()` and `xl_rsh()`
- Slice function: `xl_slice()`
- Concatenate function: `xl_concat()`
- Reinterpret function: `xl_force()`
- Internal state variables: `xl_state()`

- MATLAB Functions:

<code>disp()</code>	Displays variable values
<code>error()</code>	Displays message and abort function
<code>isnan()</code>	Tests whether a number is NaN
<code>NaN()</code>	Returns Not-a-Number
<code>num2str()</code>	Converts a number to string
<code>ones(1,N)</code>	Returns 1-by-N vector of ones
<code>pi()</code>	Returns pi
<code>zeros(1,N)</code>	Returns 1-by-N vector of zeros

## Data Types

There are three kinds of `xfix` data types: unsigned fixed-point (`xlUnsigned`), signed fixed-point (`xlSigned`), and boolean (`xlBoolean`). Arithmetic operations on these data types produce signed and unsigned fixed-point values. Relational operators produce a boolean result. Relational operands can be any `xfix` type, provided the mixture of types makes sense. Boolean variables can be compared to boolean variables, but not to fixed-point numbers; boolean variables are incompatible with arithmetic operators. Logical operators can only be applied to boolean variables. Every operation is performed in full precision, for example, with the minimum precision needed to guarantee that no information is lost.

## Literal Constants

Integer, floating-point, and boolean literals are supported. Integer literals are automatically converted to `xfix` values of appropriate width having a binary point position at zero. Floating-point literals must be converted to the `xfix` type explicitly with the `xfix()` conversion function. The predefined MATLAB values `true` and `false` are automatically converted to boolean literals.

## Assignment

The left-hand side of an assignment can only contain one variable. A variable can be assigned more than once.

## Control Flow

The conditional expression of an `if` statement must evaluate to a boolean. Switch statements can contain a `case` clause and an `otherwise` clause. The types of a switch selector and its cases must be compatible; thus, the selector can be boolean provided its cases are. All cases in a `switch` must be constant; equivalently, no `case` can depend on an input value.

When the same variable is assigned in several branches of a control statement, the types being assigned must be compatible. For example,

```
if (u > v)
    x = a;
else
    x = b;
end
```

is acceptable only if `a` and `b` are both boolean or both arithmetic.

## Constant Expressions

An expression is constant provided its value does not depend on the value of any input argument. Thus, for example, the variable `c` defined by

```
a = 1;
b = a + 2;
c = xfix({xlSigned, 10, 2}, b + 3.345);
```

can be used in any context that demands a constant.

## xfix() Conversion

The `xfix()` conversion function converts a `double` to an `xfix`, or changes one `xfix` into another having different characteristics. A call on the conversion function looks like the following

```
x = xfix(type_spec, value)
```

Here `x` is the variable that receives the `xfix`. `type_spec` is a cell array that specifies the type of `xfix` to create, and `value` is the value being operated on. The `value` can be floating point or `xfix` type. The `type_spec` cell array is defined using curly braces in the usual MATLAB method. For example,

```
xfix({xlSigned, 20, 16, xlRound, xlWrap}, 3.1415926)
```

returns an `xfix` approximation to `pi`. The approximation is signed, occupies 20 bits (16 fractional), quantizes by rounding, and wraps on overflow.

The `type_spec` consists of 1, 3, or 5 elements. Some elements can be omitted. When elements are omitted, default element settings are used. The elements specify the following properties (in the order presented): `data type`, `width`, `binary point position`, `quantization mode`, and `overflow mode`. The `data type` can be `xlBoolean`, `xlUnsigned`, or `xlSigned`. When the type is `xlBoolean`, additional elements are not needed (and must not be supplied). For other types, `width` and `binary point position` must be supplied. The `quantization` and `overflow` modes are optional, but when one is specified, the other must be as well. Three values are possible for quantization: `xlTruncate`, `xlRound`, and `xlRoundBanker`. The default is `xlTruncate`. Similarly, three values are possible for overflow: `xlWrap`, `xlSaturate`, and `xlThrowOverflow`. For `xlThrowOverflow`, if an overflow occurs during simulation, an exception occurs.

All values in a `type_spec` must be known at compilation time; equivalently, no `type_spec` value can depend on an input to the function.

The following is a more elaborate example of an `xfix()` conversion:

```
width = 10, binpt = 4;
z = xfix({xlUnsigned, width, binpt}, x + y);
```

This assignment to `x` is the result of converting `x + y` to an unsigned fixed-point number that is 10 bits wide with 4 fractional bits using `xlTruncate` for quantization and `xlWrap` for overflow.

If several `xfix()` calls need the same `type_spec` value, you can assign the `type_spec` to a variable, then use the variable for `xfix()` calls. For example, the following is allowed:

```
proto = {xlSigned, 10, 4};
x = xfix(proto, a);
y = xfix(proto, b);
```

## xfix Properties: xl\_arith, xl\_nbits, and xl\_binpt

Each `xfix` number has three properties: the arithmetic type, the bit width, and the binary point position. The **MCode** blocks provide three functions to get these properties of a fixed-point number.

The results of these functions are constants and are evaluated when Simulink compiles the model.

Function `a = xl_arith(x)` returns the arithmetic type of the input number `x`. The return value is either 1, 2, or 3 for `xlUnsigned`, `xlSigned`, or `xlBoolean` respectively.

Function `n = xl_nbits(x)` returns the width of the input number `x`.

Function `b = xl_binpt(x)` returns the binary point position of the input number `x`.

### Bit-wise Operators: `xl_or`, `xl_and`, `xl_xor`, and `xl_not`

The **MCode** block provides four built-in functions for bit-wise logical operations: `xl_or`, `xl_and`, `xl_xor`, and `xl_not`.

Function `xl_or`, `xl_and`, and `xl_xor` perform bit-wise logical or, and, and xor operations respectively. Each function is in the form of

```
x = xl_op(a, b, ...).
```

Each function takes at least two fixed-point numbers and returns a fixed-point number. All the input arguments are aligned at the binary point position.

Function `xl_not` performs a bit-wise logical not operation. It is in the form of `x = xl_not(a)`. It only takes one `xfix` number as its input argument and returns a fixed- point number.

The following are some examples of these function calls:

```
X = xl_and(a, b);
Y = xl_or(a, b, c);
Z = xl_xor(a, b, c, d);
N = xl_not(x);
```

### Shift Operators: `xl_rsh`, and `xl_lsh`

Functions `xl_lsh` and `xl_rsh` allow you to shift a sequence of bits of a fixed-point number. The function is in the form:

`x = xl_lsh(a, n)` and `x = xl_rsh(a, n)` where `a` is a `xfix` value and `n` is the number of bits to shift.

Left or right shift the fixed-point number by `n` number of bits. The right shift (`xl_rsh`) moves the fixed-point number toward the least significant bit. The left shift (`xl_lsh`) function moves the fixed-point number toward the most significant bit. Both shift functions are a full precision shift. No bits are discarded and the precision of the output is adjusted as needed to accommodate the shifted position of the binary point.

Here are some examples:

```
% left shift a 5 bits
a = xfix({xlSigned, 20, 16, xlRound, xlWrap}, 3.1415926)
b = xl_rsh(a, 5);
```

The output `b` is of type `xlSigned` with 21 bits and the binary point located at bit 21.



## Slice Function: `xl_slice`

Function `xl_slice` allows you to access a sequence of bits of a fixed-point number. The function is in the form:

```
x = xl_slice(a, from_bit, to_bit).
```

Each bit of a fixed-point number is consecutively indexed from zero for the LSB up to the MSB. For example, given an 8-bit wide number with binary point position at zero, the LSB is indexed as 0 and the MSB is indexed as 7. The block will throw an error if the `from_bit` or `to_bit` arguments are out of the bit index range of the input number. The result of the function call is an unsigned fixed-point number with zero binary point position.

Here are some examples:

```
% slice 7 bits from bit 10 to bit 4
b = xl_slice(a, 10, 4);
% to get MSB
c = xl_slice(a, xl_nbits(a)-1, xl_nbits(a)-1);
```

## Concatenate Function: `xl_concat`

Function `x = xl_concat(hi, mid, ..., low)` concatenates two or more fixed-point numbers to form a single fixed-point number. The first input argument occupies the most significant bits, and the last input argument occupies the least significant bits. The output is an unsigned fixed-point number with binary point position at zero.

## Reinterpret Function: `xl_force`

Function `x = xl_force(a, arith, binpt)` forces the output to a new type with `arith` as its new arithmetic type and `binpt` as its new binary point position. The `arith` argument can be one of `xlUnsigned`, `xlSigned`, or `xlBoolean`. The `binpt` argument must be from 0 to the bit width inclusively. Otherwise, the block will throw an error.

## State Variables: `xl_state`

An **MCode** block can have internal state variables that hold their values from one simulation step to the next. A state variable is declared with the MATLAB keyword `persistent` and must be initially assigned with an `xl_state` function call.

The following code models a 4-bit accumulator:

```
function q = accum(din, rst)
    init = 0;
    persistent s, s = xl_state(init, {xlSigned, 4, 0});
    q = s;
    if rst
        s = init;
    else
        s = s + din;
    end
```

The state variable `s` is declared as `persistent`, and the first assignment to `s` is the result of the `xl_state` invocation. The `xl_state` function takes two arguments. The first is the initial value and must be a constant. The second is the precision of the state variable. It can be a type cell array as described in the `xfix` function call. It can also be an `xfix` number. In the above code, if `s = xl_state(init, din)`, then state variable `s` will use `din` as the precision. The `xl_state` function must be assigned to a `persistent` variable.

The `x1_state` function behaves in the following way:

1. In the first cycle of simulation, the `x1_state` function initializes the state variable with the specified precision.
2. In the following cycles of simulation, the `x1_state` function retrieves the state value left from the last clock cycle and assigns the value to the corresponding variable with the specified precision.

`v = x1_state(init, precision)` returns the value of a state variable. The first input argument `init` is the initial value, the second argument `precision` is the precision for this state variable. The argument `precision` can be a cell array in the form of `{type, nbits, binpt}` or `{type, nbits, binpt, quantization, overflow}`. The `precision` argument can also be an `xfix` number.

`v = x1_state(init, precision, maxlen)` returns a vector object. The vector is initialized with `init` and will have `maxlen` for the maximum length it can be. The vector is initialized with `init`. For example, `v = x1_state(zeros(1, 8), prec, 8)` creates a vector of 8 zeros, `v = x1_state([], prec, 8)` creates an empty vector with 8 as maximum length, `v = x1_state(0, prec, 8)` creates a vector of one zero as content and with 8 as the maximum length.

Conceptually, a vector state variable is a double ended queue. It has two ends, the front which is the element at address 0 and the back which is the element at length - 1.

Methods available for vector are:

<code>val = v(idx);</code>	Returns the value of element at address <code>idx</code> .
<code>v(idx) = val;</code>	Assigns the element at address <code>idx</code> with <code>val</code> .
<code>f = v.front;</code>	Returns the value of the front end. An error is thrown if the vector is empty.
<code>v.push_front(val);</code>	Pushes <code>val</code> to the front and then increases the vector length by 1. An error is thrown if the vector is full.
<code>v.pop_front;</code>	Pops one element from the front and decreases the vector length by 1. An error is thrown if the vector is empty.
<code>b = v.back;</code>	Returns the value of the back end. An error is thrown if the vector is empty.
<code>v.push_back(val);</code>	Pushes <code>val</code> to the back and the increases the vector length by 1. An error is thrown if the vector is full.
<code>v.pop_back;</code>	Pops one element from the back and decreases the vector length by 1. An error is thrown if the vector is empty.
<code>v.push_front_pop_back(val);</code>	Pushes <code>val</code> to the front and pops one element out from the back. It's a shift operation. The length of the vector is unchanged. The vector cannot be empty to perform this operation.
<code>full = v.full;</code>	Returns <code>true</code> if the vector is full, otherwise, <code>false</code> .
<code>empty = v.empty;</code>	Returns <code>true</code> if the vector is empty, otherwise, <code>false</code> .
<code>len = v.length;</code>	Returns the number of elements in the vector.

A method of a vector that queries a state variable is called a *query method*. It has a return value. The following methods are query method: `v(idx)`, `v.front`, `v.back`, `v.full`, `v.empty`, `v.length`, `v.maxlen`. A method of a vector that changes a state variable is called an *update method*. An update method does not return any value. The following methods are update methods: `v(idx) = val`, `v.push_front(val)`, `v.pop_front`, `v.push_back(val)`, `v.pop_back`, and `v.push_front_pop_back(val)`. All query methods of a vector must be invoked before any update method is invocation during any simulation cycle. An error is thrown during model compilation if this rule is broken.

The **MCode** block can map a vector state variable into a vector of registers, a delay line, an addressable shift register, a single port ROM, or a single port RAM based on the usage of the state variable. The `xl_state` function can also be used to convert a MATLAB 1-D array into a zero-indexed constant array. If the **MCode** block cannot map a vector state variable into an FPGA device, an error message is issued during model netlist time. The following are examples of using vector state variables.

### Delay Line

The state variable in the following function is mapped into a delay line.

```
function q = delay(d, lat)
    persistent r, r = xl_state(zeros(1, lat), d, lat);
    q = r.back;
    r.push_front_pop_back(d);
```

### Line of Registers

The state variable in the following function is mapped into a line of registers.

```
function s = sum4(d)
    persistent r, r = xl_state(zeros(1, 4), d);
    S = r(0) + r(1) + r(2) + r(3);
    r.push_front_pop_back(d);
```

### Vector of Constants

The state variable in the following function is mapped into a vector of constants.

```
function s = myadd(a, b, c, d, nbits, binpt)
    p = {xlSigned, nbits, binpt, xlRound, xlSaturate};
    persistent coef, coef = xl_state([3, 7, 3.5, 6.7], p);
    s = a*coef(0) + b*coef(1) + c*coef(2) + c*coef(3);
```

### Addressable Shift Register

The state variable in the following function is mapped into an addressable shift register.

```
function q = addrsr(d, addr, en, depth)
    persistent r, r = xl_state(zeros(1, depth), d);
    q = r(addr);
    if en
        r.push_front_pop_back(d);
    end
```

### Single Port ROM

The state variable in the following function is mapped into a single port ROM.

```
function q = addrsr(contents, addr, arith, nbits, binpt)
    proto = {arith, nbits, binpt};
    persistent mem, mem = xl_state(contents, proto);
```

```
q = mem(addr);
```

### Single Port RAM

The state variable in the following function is mapped to a single port RAM in fabric (Distributed RAM).

```
function dout = ram(addr, we, din, depth, nbits, binpt)
    proto = {xlSigned, nbits, binpt};
    persistent mem, mem = xl_state(zeros(1, depth), proto);
    dout = mem(addr);
    if we
        mem(addr) = din;
    end
```

The state variable in the following function is mapped to BlockRAM as a single port RAM.

```
function dout = ram(addr, we, din, depth, nbits, binpt, ram_enable)
    proto = {xlSigned, nbits, binpt};
    persistent mem, mem = xl_state(zeros(1, depth), proto);
    persistent dout_temp, dout_temp = xl_state(0, proto);
    dout = dout_temp;
    dout_temp = mem(addr);
    if we
        mem(addr) = din;
    end
```

### MATLAB Functions

#### disp()

Displays the expression value. In order to see the printing on the MATLAB console, the option **Enable printing with disp** must be checked on the **Advanced** tab of the **MCode** block parameters dialog box. The argument can be a string, an **xfix** number, or an **MCode** state variable. If the argument is an **xfix** number, it will print the type, binary value, and double precision value. For example, if variable **x** is assigned with `xfix({xlSigned, 10, 7}, 2.75)`, the `disp(x)` will print the following line:

```
type: Fix_10_7, binary: 010.1100000, double: 2.75
```

If the argument is a vector state variable, `disp()` will print out the type, maximum length, current length, and the binary and double values of all the elements. For each simulation step, when **Enable printing with disp** is on and when a `disp()` function is invoked, a title line is printed for the corresponding block. The title line includes the block name, Simulink simulation time, and FPGA clock number.

The following **MCode** function shows several examples of using the `disp()` function.

```
function x = testdisp(a, b)
    persistent dly, dly = xl_state(zeros(1, 8), a);
    persistent rom, rom = xl_state([3, 2, 1, 0], a);
    disp('Hello World!');
    disp(['num2str(dly) is ', num2str(dly)]);
    disp('disp(dly) is ');
    disp(dly);
    disp('disp(rom) is ');
    disp(rom);
    a2 = dly.back;
    dly.push_front_pop_back(a);
    x = a + b;
    disp(['a = ', num2str(a), ', ', ', ...
```

```
'b = ', num2str(b), ', ', ' ', ...
'x = ', num2str(x)];
disp(num2str(true));
disp('disp(10) is');
disp(10);
disp('disp(-10) is');
disp(-10);
disp('disp(a) is ');
disp(a);
disp('disp(a == b)');
disp(a==b);
```

The following lines are the result for the first simulation step.

```
xlmcode_testdisp/MCode (Simulink time: 0.000000, FPGA clock: 0)
Hello World!
num2str(dly) is [0.000000, 0.000000, 0.000000, 0.000000, 0.000000,
0.000000, 0.000000, 0.000000]
disp(dly) is
type: Fix_11_7,
maxlen: 8,
length: 8,
0: binary 0000.0000000, double 0.000000,
1: binary 0000.0000000, double 0.000000,
2: binary 0000.0000000, double 0.000000,
3: binary 0000.0000000, double 0.000000,
4: binary 0000.0000000, double 0.000000,
5: binary 0000.0000000, double 0.000000,
6: binary 0000.0000000, double 0.000000,
7: binary 0000.0000000, double 0.000000,
disp(rom) is
type: Fix_11_7,
maxlen: 4,
length: 4,
0: binary 0011.0000000, double 3.0,
1: binary 0010.0000000, double 2.0,
2: binary 0001.0000000, double 1.0,
3: binary 0000.0000000, double 0.0,
a = 0.000000, b = 0.000000, x = 0.000000
1
disp(10) is
type: UFix_4_0, binary: 1010, double: 10.0
disp(-10) is
type: Fix_5_0, binary: 10110, double: -10.0
disp(a) is
type: Fix_11_7, binary: 0000.0000000, double: 0.000000
disp(a == b)
type: Bool, binary: 1, double: 1
```

You can find the above example in the topic [Compiling MATLAB into an FPGA](#).

### error()

Displays message and abort function. See Matlab help on this function for more detailed information. Message formatting is not supported by the MCode block. For example:

```
if latency <=0
    error('latency must be a positive');
end
```

### isnan()

Returns true for Not-a-Number. `isnan(X)` returns true when `X` is Not-a-Number. `X` must be a scalar value of double or Xilinx fixed-point number. This function is not supported for vectors or matrices. For example:

```
if isnan(incr) & incr == 1
    cnt = cnt + 1;
end
```

### NaN()

The `NaN()` function generates an IEEE arithmetic representation for Not-a-Number. A NaN is obtained as a result of mathematically undefined operations like `0.0/0.0` and `inf-inf`. `NaN(1,N)` generates a 1-by-`N` vector of NaN values. Here are examples of using NaN.

```
if x < 0
    z = NaN;
else
    z = x + y;
end
```

### num2Str()

Converts a number to a string. `num2str(X)` converts the `X` into a string. `X` can be a scalar value of double, a Xilinx fixed-point number, or a vector state variable. The default number of digits is based on the magnitude of the elements of `X`. Here's an example of `num2str`:

```
if opcode <=0 | opcode >= 10
    error(['opcode is out of range: ', num2str(opcode)]);
end
```

### ones()

The `ones()` function generates a specified number of one values. `ones(1,N)` generates a 1-by-`N` vector of ones. `ones(M,N)` where `M` must be 1. It's usually used with `xl_state()` function call. For example, the following line creates a 1-by-4 vector state variable initialized to `[1, 1, 1, 1]`.

```
persistant m, m = xl_state(ones(1, 4), proto)
```

### zeros()

The `zeros()` function generates a specified number of zero values. `zeros(1,N)` generates a 1-by-`N` vector of zeros. `zeros(M,N)` where `M` must be 1. It's usually used with `xl_state()` function call. For example, the following line creates a 1-by-4 vector state variable initialized to `[0, 0, 0, 0]`.

```
persistant m, m = xl_state(zeros(1, 4), proto)
```

## FOR Loop

FOR statement is fully unrolled. The following function sums  $n$  samples.

```
function q = sum(din, n)
    persistent regs, regs = xl_state(zeros(1, 4), din);
    q = reg(0);
    for i = 1:n-1
        q = q + reg(i);
    end
    regs.push_front_pop_back(din);
```

The following function does a bit reverse.

```
function q = bitreverse(d)
    q = xl_slice(d, 0, 0);
    for i = 1:xl_nbits(d)-1
        q = xl_concat(q, xl_slice(d, i, i));
    end
```

## Variable Availability

MATLAB code is sequential (for example, statements are executed in order). The **MCode** block requires that every possible execution path assigns a value to a variable before it is used (except as a left-hand side of an assignment). When this is the case, we say the variable is *available* for use. The **MCode** block will throw an error if its M-code function accesses unavailable variables.

Consider the following M-code:

```
function [x, y, z] = test1(a, b)
    x = a;
    if a>b
        x = a + b; y = a;
    end
    switch a
        case 0
            z = a + b;
        case 1
            z = a - b;
    end
```

Here  $a$ ,  $b$ , and  $x$  are available, but  $y$  and  $z$  are not. Variable  $y$  is not available because the **if** statement has no **else**, and variable  $z$  is not available because the **switch** statement has no **otherwise** part.

## DEBUG MCode

There are two ways to debug your **MCode**. One is to insert `disp()` functions in your code and enable printing; the other is to use the MATLAB debugger. For usage of the `disp()` function, please reference the topic [disp\(\)](#).

If you want to use the MATLAB debugger, you need to check the **Enable MATLAB debugging** option on the **Advanced** tab of the **MCode** block parameters dialog box. Then you can open your MATLAB function with the MATLAB editor, set break points, and debug your M-function. Just be aware that every time you modify your script, you need to execute a `clear functions` command in the MATLAB console.

To start debugging your M-function, you need to first check the **Enable MATLAB debugging** checkbox on the **Advanced** tab of the **MCode** block parameters dialog, then click the **OK** or **Apply** button.

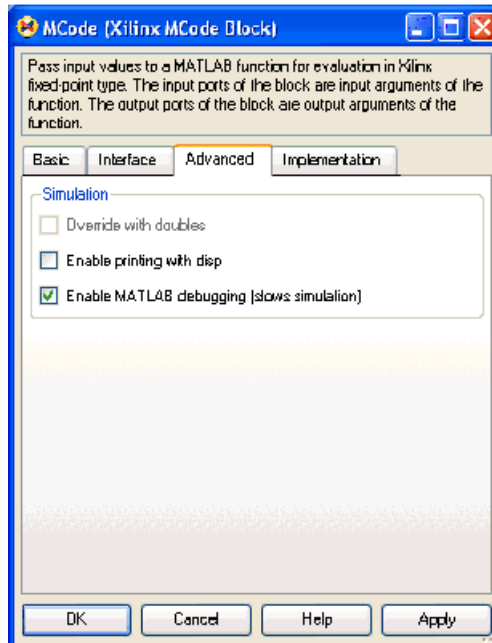

Now you can edit the M-file with the MATLAB editor and set break points as needed.

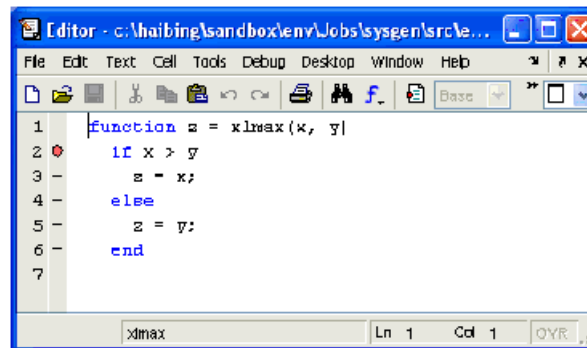



During the Simulink simulation, the MATLAB debugger will stop at the break points you set when the break points are reached.

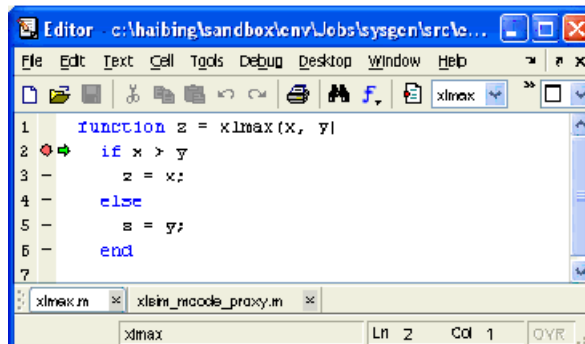

When debugging, you can also examine the values of the variables by typing the variable names in the MATLAB console.

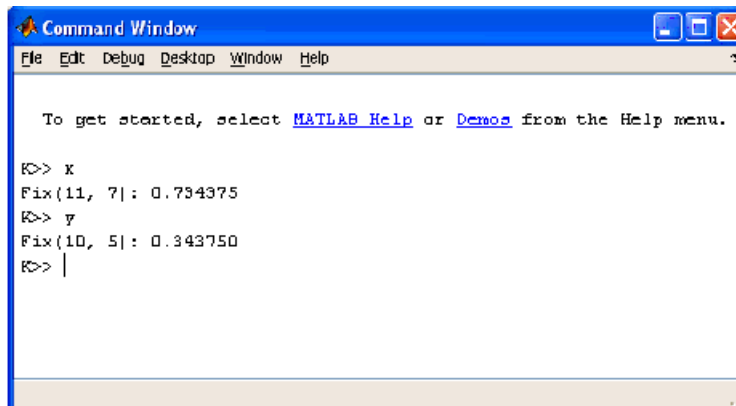

There is one special case to consider when the function for an **MCode** block is executed from the MATLAB debugger. A `switch/case` expression inside an **MCode** block must be type `xfix`, however, executing a `switch/case` expression from the MATLAB console requires that the expression be a `double` or `char`. To facilitate execution in the MATLAB console, a call to `double()` must be added. For example, consider the following:

```
switch i
case 0
    x = 1
case 1
    x = 2
end
```

where `i` is type `xfix`. To run from the console this code must be changed to

```
switch double(i)
case 0
    x = 1
case 1
    x = 2
end
```

The `double()` function call only has an effect when the M code is run from the console. The **MCode** block ignores the `double()` call.

## Passing Parameters

It is possible to use the same M-function in different **MCode** blocks, passing different parameters to the M-function so that each block can behave differently. This is achieved by binding input arguments to some values. To bind the input arguments, select the **Interface** tab on the block GUI. After you bind those arguments to some values, these M-function arguments will not be shown as input ports of the **MCode** block.

Consider for example, the following M-function:

```
function dout = xl_sconvert(din, nbits, binpt)
proto = {xlsigned, nbits, binpt};
dout = xfix(proto, din);
```

The following figures shows how the bindings are set for the **din** input of two separate `xl_sconvert` blocks.

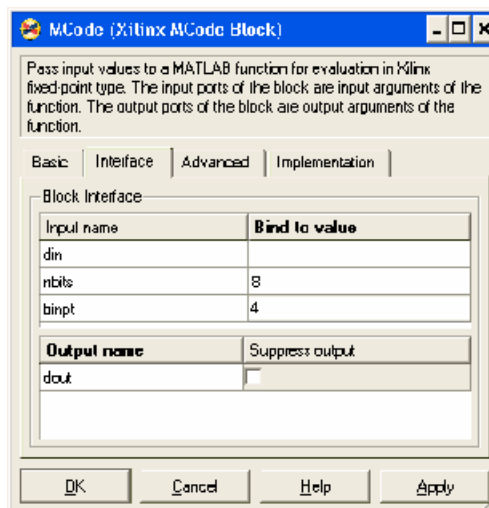
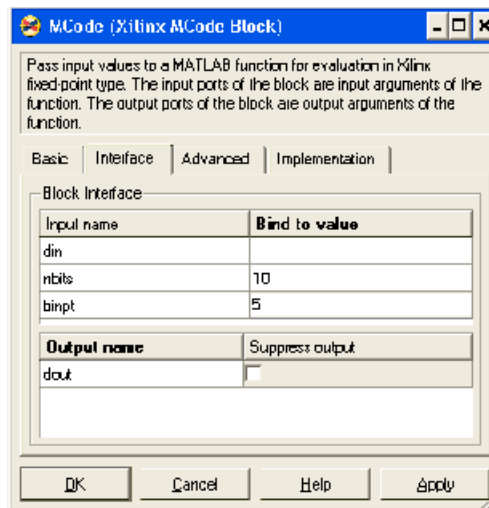

The following figure shows the block diagram after the model is compiled.

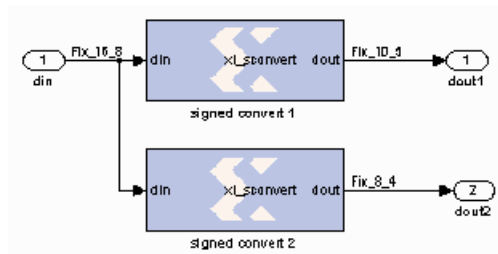

The parameters can only be of type double or they can be logical numbers.

### Optional Input Ports

The parameter passing mechanism allows the **MCode** block to have optional input ports. Consider for example, the following M-function:

```
function s = xl_m_addsub(a, b, sub)
    if sub
        s = a - b;
    else
        s = a + b;
    end
end
```

If `sub` is set to be `false`, the **MCode** block that uses this M-function will have two input ports `a` and `b` and will perform full precision addition. If it is set to an empty cell array `{}`, the block will have three input ports `a`, `b`, and `sub` and will perform full precision addition or subtraction based on the value of input port `sub`.

The following figure shows the block diagram of two blocks using the same `xl_m_addsub` function, one having two input ports and one having three input ports.

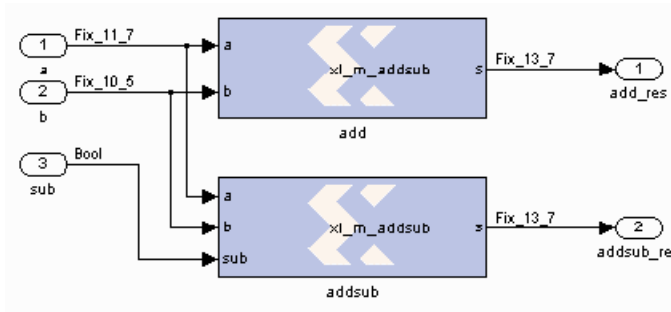

## Constructing a State Machine

There are two ways to build a state machine using an **MCode** block. One way is to specify a stateless transition function using a MATLAB function and pair an **MCode** block with one or more state register blocks. Usually the **MCode** block drives a register with the value representing the next state, and the register feeds back the current state into the **MCode** block. For this to work, the precision of the state output from the **MCode** block must be static, that is, independent of any inputs to the block. Occasionally you might find you need to use `xfix()` conversions to force static precision. The following code illustrates this:

```
function nextstate = fsm1(currentstate, din)
    % some other code
    nextstate = currentstate;
    switch currentstate
        case 0, if din==1, nextstate = 1; end
    end
    % a xfix call should be used at the end
    nextstate = xfix({xlUnsigned, 2, 0}, nextstate);
```

Another way is to use state variables. The above function can be re-written as follows:

```
function currentstate = fsm1(din)
    persistent state, state=xl_state(0, {xlUnsigned, 2, 0});
    currentstate = state;
    switch double(state)
        case 0, if din==1; state = 1; end
    end
```

## Reset and Enable Signals for State Variables

The **MCode** block can automatically infer register reset and enable signals for state variables when conditional assignments to the variables contain two or fewer branches.

For example, the following M-code infers an enable signal for conditional assignment of `persistent` state variable `r1`:

```
function myFn = aFn(en, a)
    persistent r1, r1 = xl_state(0, {xlUnsigned, 2, 0});
    myFn = r1;
    if en
        r1 = r1 + a
    else
        r1 = r1
    end
```

There are two branches in the conditional assignment to persistent state variable `r1`. A register is used to perform the conditional assignment. The input of the register is connected to `r1 + a`, the output of the register is `r1`. The register's enable signal is inferred; the enable signal is connected to `en`, when `en` is asserted. Persistent state variable `r1` is assigned to `r1 + a` when `en` evaluates to `false`, the enable signal on the register is de-asserted resulting in the assignment of `r1` to `r1`.

The following M-code will also infer an enable signal on the register used to perform the conditional assignment:

```
function myFn = aFn(en, a)
    persistent r1, r1 = xl_state(0, {xlUnsigned, 2, 0});
    myFn = r1;
    if en
        r1 = r1 + a
    end
```

An enable is inferred instead of a reset because the conditional assignment of persistent state variable `r1` is to a non-constant value, `r1 + a`.

If there were three branches in the conditional assignment of persistent state variable `r1`, the enable signal would not be inferred. The following M-code illustrates the case where there are three branches in the conditional assignment of persistent state variable `r1` and the enable signal is not inferred:

```
function myFn = aFn(en, en2, a, b)
    persistent r1, r1 = xl_state(0, {xlUnsigned, 2, 0});
    if en
        r1 = r1 + a
    elseif en2
        r1 = r1 + b
    else
        r1 = r1
    v
```

The reset signal can be inferred if a persistent state variable is conditionally assigned to a constant; the reset is synchronous. Consider the following M-code example which infers a reset signal for the assignment of persistent state variable `r1` to `init`, a constant, when `rst` evaluates to true and `r1 + 1` otherwise:

```
function myFn = aFn(rst)
    persistent r1, r1 = xl_state(0, {xlUnsigned, 4, 0});
    myFn = r1;
    init = 7;
    if (rst)
        r1 = init
    else
        r1 = r1 + 1
    end
```

The M-code example above which infers reset can also be written as:

```
function myFn = aFn(rst)
    persistent r1, r1 = xl_state(0, {xlUnsigned, 4, 0});
    init = 1;
    myFn = r1;
    r1 = r1 + 1
    if (rst)
        r1 = init
    end
```

In both code examples above, the reset signal of the register containing persistent state variable `r1` is assigned to `rst`. When `rst` evaluates to true, the register's reset input is asserted and the persistent state variable is assigned to constant `init`. When `rst` evaluates to false, the register's reset input is de-asserted and persistent state variable `r1` is assigned to `r1 + 1`. Again, if the conditional assignment of a persistent state variable contains three or more branches, a reset signal is not inferred on the persistent state variable's register.

It is possible to infer reset and enable signals on the register of a single persistent state variable. The following M-code example illustrates simultaneous inference of reset and enable signals for the persistent state variable `r1`:

```
function myFn = aFn(rst,en)
    persistent r1, r1 = xl_state(0, {xlUnsigned, 4, 0});
    myFn = r1;
    init = 0;
    if rst
        r1 = init
    else
        if en
            r1 = r1 + 1
        end
    end
end
```

The reset input for the register of persistent state variable `r1` is connected to `rst`; when `rst` evaluates to `true`, the register's reset input is asserted and `r1` is assigned to `init`. The enable input of the register is connected to `en`; when `en` evaluates to `true`, the register's enable input is asserted and `r1` is assigned to `r1 + 1`. It is important to note that an inferred reset signal takes precedence over an inferred enable signal regardless of the order of the conditional assignment statements. Consider the second code example above; if both `rst` and `en` evaluate to `true`, persistent state variable `r1` would be assigned to `init`.

Inference of reset and enable signals also works for conditional assignment of persistent state variables using switch statements, provided the switch statements contain two or less branches.

The **MCode** block performs dead code elimination and constant propagation compiler optimizations when generating code for the FPGA. This can result in the inference of reset and/or enable signals in conditional assignment of persistent state variables, when one of the branches is never executed. For this to occur, the conditional must contain two branches that are executed after dead code is eliminated and constant propagation is performed.

## Inferring Registers

Registers are inferred in hardware by using persistent variables, however, the right coding style must be used. Consider the two code segments in the following function:

```
function [out1, out2] = persistent_test02(in1, in2)
    persistent ff1, ff1 = xl_state(0, {xlUnsigned, 2, 0});
    persistent ff2, ff2 = xl_state(0, {xlUnsigned, 2, 0});
    %code segment 1
    out1 = ff1; %these two statements infer a register for ff1
    ff1 = in1;
    %code segment 2
    ff2 = in2; %these two statements do NOT infer a register for ff2
    out2 = ff2;
end
```

In code segment 1, the value of persistent variable `ff1` is assigned to `out1`. Since `ff1` is persistent, it is assumed that its current value was assigned in the previous cycle. In the next statement, the value of `in1` is assigned to `ff1` so it can be saved for the next cycle. This infers a register for `ff1`.

In code segment 2, the value of `in2` is first assigned to persistent variable `ff2`, then assigned to `out2`. These two statements can be completed in one cycle, so a register is not inferred. If you need to insert delay into combinational logic, refer to the next topic.

## Pipelining Combinational Logic

The generated FPGA bitstream for an MCode block might contain many levels of combinational logic and hence a large critical path delay. To allow a downstream logic synthesis tool to automatically pipeline the combinational logic, you can add delay blocks before the MCode block inputs or after the MCode block outputs. These delay blocks should have the parameter **Implement using behavioral HDL** set, which instructs the code generator to implement delay with synthesizable HDL. You can then instruct the downstream logic synthesis tool to implement register re-timing or register balancing. As an alternative approach, you can use the vector state variables to model delays.

## Shift Operations with Multiplication and Division

The MCode block can detect when a number is multiplied or divided by constants that are powers of two. If detected, the MCode block will perform a shift operation. For example, multiplying by 4 is equivalent to left shifting 2 bits and dividing by 8 is equivalent to right shifting 3 bits. A shift is implemented by adjusting the binary point, expanding the `fix` container as needed. For example, a `Fix_8_4` number multiplied by 4 will result in a `Fix_8_2` number, and a `Fix_8_4` number multiplied by 64 will result in a `Fix_10_0` number.

## Using the `xl_state` Function with Rounding Mode

The `xl_state` function call creates an `xfix` container for the state variable. The container's precision is specified by the second argument passed to the `xl_state` function call. If precision uses `xlRound` for its rounding mode, hardware resources is added to accomplish the rounding. If rounding the initial value is all that is required, an `xfix` call to round a constant does not require additional hardware resources. The rounded value can then be passed to the `xl_state` function. For example:

```
init = xfix({xlSigned,8,5,xlRound,xlWrap}, 3.14159);
persistent s, s = xl_state(init, {xlSigned, 8, 5});
```

## Block Parameters Dialog Box

The block parameters dialog box can be invoked by double-clicking the block icon in a Simulink model.

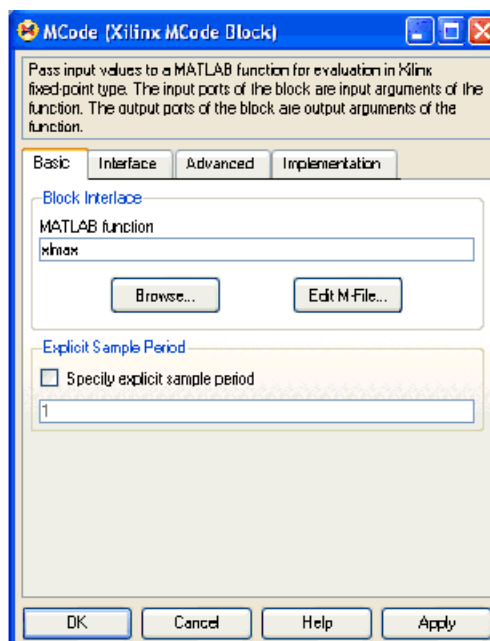

As described earlier in this topic, the **MATLAB function** parameter on an **MCode** block tells the name of the block's function, and the **Interface** tab specifies a list of constant inputs and their values.

Other parameters used by this block are explained in the topic [Common Options in Block Parameter Dialog Boxes](#).



## ModelSim

This block is listed in the following Xilinx Blockset libraries: *Tools and Index*.



The System Generator **Black Box** block provides a way to incorporate existing HDL files into a model. When the model is simulated, co-simulation can be used to allow black boxes to participate. The ModelSim HDL co-simulation block configures and controls co-simulation for one or several black boxes.

During a simulation, each ModelSim block spawns one copy of ModelSim, and therefore uses one ModelSim license. If licenses are scarce, several black boxes can share the same block.

In detail, the ModelSim block does the following:

- Constructs the additional VHDL and Verilog needed to allow black box HDL to be simulated inside ModelSim.
- Spawns a ModelSim session when a Simulink simulation starts.
- Mediates the communication between Simulink and ModelSim.
- Reports if errors are detected when black box HDL is compiled.
- Terminates ModelSim, if appropriate, when the simulation is complete.

**Note:** The ModelSim block only supports symbolic radix in the ModelSim tool. In symbolic radix, ModelSim displays the actual values of an enumerated type and also converts an object's value to an appropriate representation for other radix forms. Please refer to the ModelSim documentation for more information on symbolic radix.

### Block Parameters

The block parameters dialog box can be invoked by double-clicking the icon in your Simulink model.

#### Basic tab

Parameters specific to the Basic tab are as follows:

**Run co-simulation in directory:** ModelSim is started in the directory named by this field. The directory is created if necessary. All black box files are copied into this directory, as are the auxiliary files System Generator produces for co-simulation. Existing files are overwritten silently. The directory can be specified as an absolute or relative path. Relative paths are interpreted with respect to the directory in which the Simulink .mdl file resides.

**Open waveform viewer:** When this checkbox is selected, the ModelSim waveform window opens automatically, displaying a standard set of signals. The signals include all inputs and outputs of all black boxes and all clock and clock enable signals supplied by System Generator. The signal display can be customized with an auxiliary tcl script. To specify the script, select Add Custom Scripts and enter the script name (e.g., myscript.do) in the Script to Run After vsim field. An example showing a customized waveform viewer is included in

<ISE\_Design\_Suite\_tree>/sysgen/examples/black\_box/example5. This example is in the topic [Advanced Black Box Example Using ModelSim](#).

**Leave ModelSim open at end of simulation:** When this checkbox is selected, the ModelSim session is left open after the Simulink simulation has finished.

**Skip compilation (use previous results):** When this checkbox is selected, the ModelSim compilation phase is skipped in its entirety for all black boxes that are using the ModelSim block for HDL co-simulation. To select this option is to assert that: (1) underneath the directory in which

ModelSim will run, there exists a ModelSim work directory, and (2) that the work directory contains up-to-date ModelSim compilation results for all black box HDL. Selecting this option can greatly reduce the time required to start-up the simulation, however, if it is selected when inappropriate, the simulation can fail to run or run but produce false results.

## Advanced tab

Parameters specific to the Advanced tab are as follows:

**Include Verilog unisim library:** Selecting this checkbox ensures that ModelSim includes the Verilog UniSim library during simulation. Note: the Verilog unisim library must be mapped to UNISIMS\_VER in ModelSim. In addition, selecting this checkbox ensures the "glbl.v" module is compiled and invoked during simulation.

**Add custom scripts:** The term "script" refers to a Tcl macro file (DO file) executed by ModelSim. Selecting this checkbox activates the fields **Script to Run Before Starting Compilation**, **Script to Run in Place of "vsim"**, and **Script to Run after "vsim"**. The DO file scripts named in these fields are not run unless this checkbox is selected.

**Script to run before starting compilation:** Enter the name of a Tcl macro file (DO file) that is to be executed by ModelSim before compiling black box HDL files.

**Note:** For information on how to write a ModelSim macro file (DO file) refer to the Chapter in the ModelSim User's Manual titled **Tcl and macros (DO files)**.

**Script to run in place of "vsim":** ModelSim uses Tcl (tool command language) as the scripting language for controlling and extending the tool. Enter the name of a ModelSim Tcl macro file (DO file) that is to be executed by the ModelSim **do** command at the point when System Generator would ordinarily instruct ModelSim to begin a simulation. To start the simulation after the macro file starts executing, you must place a **vsim** command inside the macro file.

Normally, if this parameter is left blank, or Add custom scripts is not selected, then System Generator instructs ModelSim to execute the default command **vsim \$stoplevel -title {System Generator Co-Simulation (from block \$blockname)}** Here **\$stoplevel** is the name of the top level entity for simulation (e.g., work.my\_model\_mti\_block) and **\$blockname** is the name of the ModelSim block in the Simulink model associated with the current co-simulation. To avoid problems, certain characters in the block name (e.g., newlines) are sanitized.

If this parameter is not blank and **Add custom scripts** is selected, then System Generator instead instructs ModelSim to execute **do \$\* \$stoplevel \$blockname**. Here **\$stoplevel** and **\$blockname** are as above and **\$\*** represents the literal text entered in the field. If, for example the literal text is 'foo.do', then ModelSim executes **foo.do**. This macro file can then reference **\$stoplevel** and **\$blockname** as \$1 and \$2, respectively. Thus, the command **vsim \$1** inside of the macro file **foo.do** runs vsim on topLevel.

**Script to run after "vsim":** Enter the name of a Tcl macro file (DO file) that is to be executed by ModelSim after all the HDL for black boxes has been successfully compiled, and after the ModelSim simulation has completed successfully. If the **Open Waveform Viewer** checkbox has been selected, System Generator issues all commands it ordinarily uses to open and customize the waveform viewer before running this script. This allows you to customize the waveform viewer as desired (either by adding signals to the default viewer or by creating a fully custom viewer). The black box tutorial includes an example that customizes the waveform viewer.

It is often convenient to use relative paths in a custom script. Relative paths are interpreted with respect to the directory that contains the model's MDL file. A relative path in the Run co-simulation in directory field is also interpreted with respect to the directory that contains the model's MDL file. Thus, for example, if Run co-Simulation in directory specifies ./modelsim as the directory in which ModelSim should run, the relative path ../foo.do in a script definition field refers to a file named foo.do in the directory that contains the .mdl.

## Fine Points

The time scale in ModelSim matches that in Simulink, for example, one second of Simulink simulation time corresponds to one second of ModelSim simulation time. This makes it easy to compare times at which events occur in the two settings. The typically large Simulink time scale is also useful because it allows System Generator to schedule events without running into problems related to the timing characteristics of the HDL model. Users needn't worry too much about the details System Generator event scheduling in co-simulation models. The following example is offered to illustrate the broader points.

This example model shown here can be found in the System Generator directory <ISE\_Design\_Suite\_tree>/sysgen/example/black\_box/example4. The example is also discussed in the topic [Importing a Verilog Module](#).

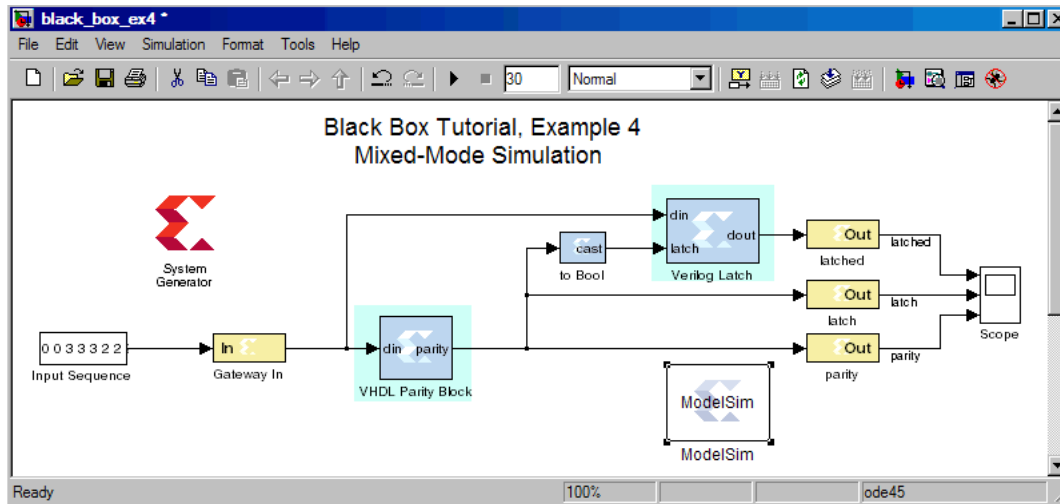

When the above model is run, the following waveforms are displayed by ModelSim:

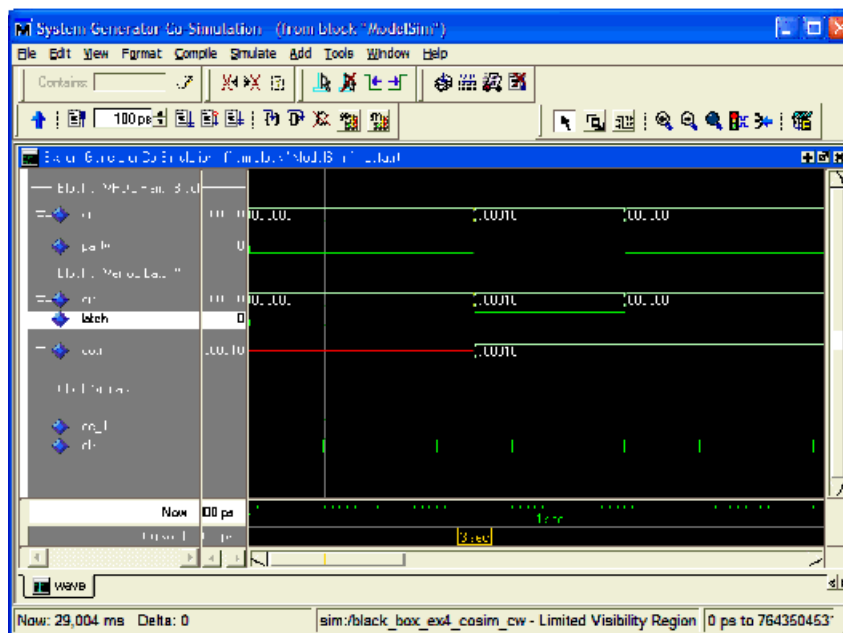

At the time scale presented here (the above shows a time interval of six seconds), the rising clock edge at three seconds and the corresponding transmission of data through each of the two black boxes appear simultaneous, much as they do in the Simulink simulation. Looking at the model, however, it is clear that the output of the first black box feeds the second black box. Both of the black boxes in this model have combinational feed-throughs, for example, changes on inputs translate into immediate changes on outputs. Zooming in toward the three second event reveals how System Generator has resolved the dependencies. Note the displayed time interval has shrunk to ~20 ms.

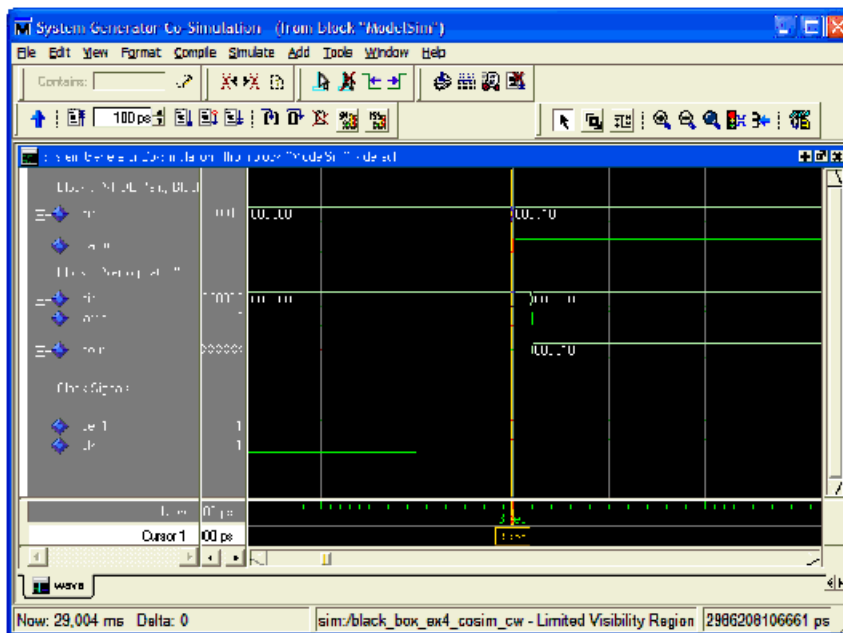

The above figure reveals that System Generator has shifted the rising clock edge so it occurs before the input value is collected from Simulink and presented to the first of the black boxes. It then allows the value to propagate through the first black box and presents the result to the second at a slightly later time. Zooming in still further shows that the HDL model for the first black box includes a propagation delay which System Generator has effectively abstracted away through the use of large

time scales. The actual delay through the first black box (exactly 1 ns) can be seen in the figure below.

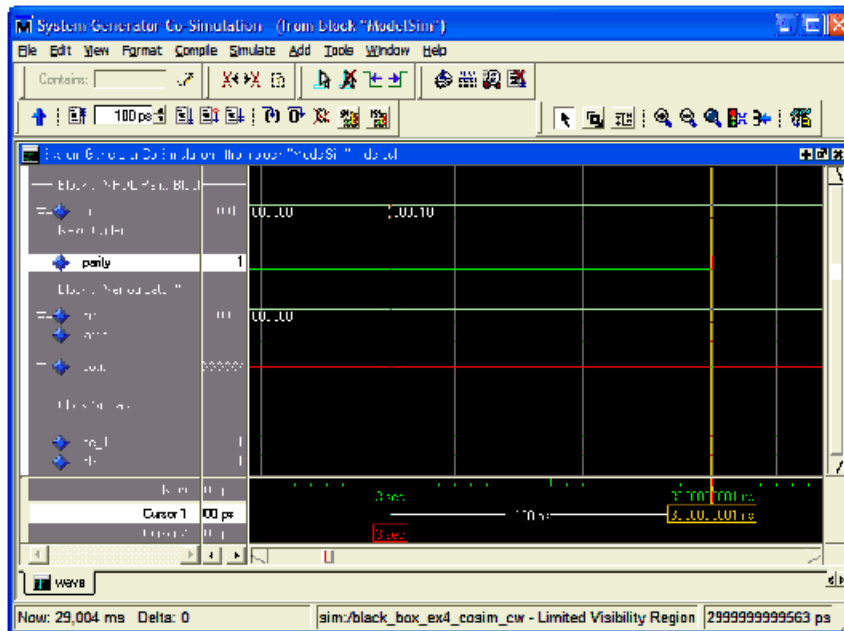

In propagating data through black box components, System Generator allocates 1/ 1000 of the system clock period down to 1 $\mu$ s, then shrinks the allocation to 1/100 of the system clock period down to 5ns, and below that threshold resorts to delta-delay stepping, for example, issuing "run 0 ns" commands to ModelSim. If the HDL includes timing information (e.g., transport delays) and the Simulink System Period is set too low, then the simulation results are incorrect. The above model begins to fail when the Simulink system period setting is reduced below 5e-7, which is the point at which System Generator resorts to delta-delay stepping of the black boxes for data propagation.

## Mult

This block is listed in the following Xilinx Blockset libraries: *Math, Floating-Point and Index*.



The Xilinx Mult block implements a multiplier. It computes the product of the data on its two input ports, producing the result on its output port.

### Block Parameters

The block parameters dialog box can be invoked by double-clicking the icon in your Simulink model.

#### Basic tab

Parameters specific to the Basic tab are as follows:

##### Precision:

This parameter allows you to specify the output precision for fixed-point arithmetic. Floating point output always has **Full** precision.

- **Full:** The block uses sufficient precision to represent the result without error.
- **User Defined:** If you don't need full precision, this option allows you to specify a reduced number of total bits and/or fractional bits.

##### User-Defined Precision

###### Fixed-point Precision

- ◆ **Signed (2's comp):** The output is a Signed (2's complement) number.
- ◆ **Unsigned:** The output is an Unsigned number.
- ◆ **Number of bits:** specifies the bit location of the binary point of the output number, where bit zero is the least significant bit.
- ◆ **Binary point:** position of the binary point. in the fixed-point output

###### Quantization

Refer to the section [Overflow and Quantization](#).

###### Overflow

Refer to the section [Overflow and Quantization](#).

###### Optional Port

- Provide enable port
- **Latency:** This defines the number of sample periods by which the block's output is delayed.

##### Saturation and Rounding of User Data Types in a Multiplier

When saturation or rounding is selected on the user data type of a multiplier, latency is also distributed so as to pipeline the saturation/rounding logic first and then additional registers are added to the core. For example, if a latency of three is selected and rounding/saturation is selected, then the first register is placed after the rounding or saturation logic and two registers are placed to pipeline the core. Registers are added to the core until optimum pipelining is reached and then further registers are placed after the rounding/saturation logic. However, if the

data type you select does not require additional saturation/rounding logic, then all the registers are used to pipeline the core.

## Implementation tab

Parameters specific to the Implementation tab are as follows:

**Use behavioral HDL (otherwise use core):** The block is implemented using behavioral HDL. This gives the downstream logic synthesis tool maximum freedom to optimize for performance or area.

**Note:** For Floating-point operations, the block always uses the Floating-point Operator core.

Core Parameters

- **Optimize for Speed|Area:** directs the block to be optimized for either Speed or Area
- **Use embedded multipliers:** This field specifies that if possible, use the XtremeDSP slice (DSP48 type embedded multiplier) in the target device.
- **Test for optimum pipelining:** Checks if the Latency provided is at least equal to the optimum pipeline length. Latency values that pass this test imply that the core produced is optimized for speed.

Other parameters used by this block are explained in the topic [Common Options in Block Parameter Dialog Boxes](#).

## LogiCORE™ Documentation

[LogiCORE IP Multiplier v11.2](#)

[LogiCORE IP Floating-Point Operator v6.1](#)

## Device Support

Virtex-7 and Kintex-7, Virtex-6, Virtex-5, Virtex-4,  
Spartan-6, Spartan-3/XA, Spartan-3E/XA, Spartan-3A/3AN/3A DSP/XA

Floating-Point support is restricted to the following devices:

Virtex-7, Kintex-7, Virtex-6, Spartan-6

## Multiple Subsystem Generator

This block is listed in the following Xilinx Blockset libraries: *Shared Memory and Index*.



The Xilinx Multiple Subsystem Generator block wires two or more System Generator designs into a single top-level HDL component that incorporates multiple clock domains. This top-level component includes the logic associated with each System Generator design and additional logic to allow the designs to communicate with one another.

In software, this communication is handled using shared memory and shared memory derivative blocks (e.g., Shared Memory, To/From FIFO, and To/From Register blocks). In hardware, the designs are interfaced to hardware implementations (e.g., dual-port memory, asynchronous FIFOs, and registers) of their shared memory counterparts, making it possible to partition and implement systems with multiple clock domains.

**Note:** The Multiple Subsystem Generator block does not support designs that include an EDK Processor block

### Block Parameters

The block parameters dialog box can be invoked by double-clicking the Multiple Subsystem Generator icon in your Simulink model.

Parameters specific to the Multiple Subsystem Generator block are:

- **Part:** Defines the FPGA part to be used.
- **Target Directory:** Defines where System Generator should write compilation results. Because System Generator and the FPGA physical design tools typically create many files, it is best to specify a separate target directory, for example, a directory other than the directory containing your Simulink model files.
- **Synthesis Tool:** Specifies the tool to be used to synthesize the design. Tool choices are Synplify's Synplify Pro or Synplify, and Xilinx's XST.
- **Hardware Description Language:** Tells the type of HDL language (Verilog or VHDL) that should be generated for each design.

### Design Generation

The Multiple Subsystem Generator block performs the following steps when you press the **Generate** button in the block's parameters dialog box:

1. It determines the System Generator designs that should be generated and wired together.
2. It configures each System Generator design with appropriate settings and generates the designs individually.
3. It produces hardware implementations (e.g., core netlists) for the shared memory blocks.
4. It generates a top-level HDL file that includes the System Generator designs wired together with the corresponding shared memory hardware implementations.

The Multiple Subsystem Generator block determines which subsystems to implement and wire together by searching for subsystems that contain System Generator blocks that reside at the same level of hierarchy as the Multiple Subsystem Generator block. Inclusion of the Multiple Subsystem Generator block in a Simulink design is restricted in the following ways:

- System Generator blocks can not be included in the same level of hierarchy as the Multiple Subsystem Generator block.



- There must be at least two master System Generator tokens in subsystems located in the same level of hierarchy as the Multiple Subsystem Generator block.
- Only one Multiple Subsystem Generator block can be included in a given level of hierarchy.

For example, consider the example block diagram shown below. This diagram comprises two subsystems, and it is assumed that each subsystem contains a System Generator token along with some amount of System Generator logic. Note that although only two subsystems are shown in the diagram, the Multiple Subsystem Generator block can accommodate any number of subsystems. A Multiple Subsystem Generator block is included in the same level of hierarchy as the two subsystems. When a user chooses to generate the overall design using the Multiple Subsystem Generator block, the subsystems are generated and then wired together.

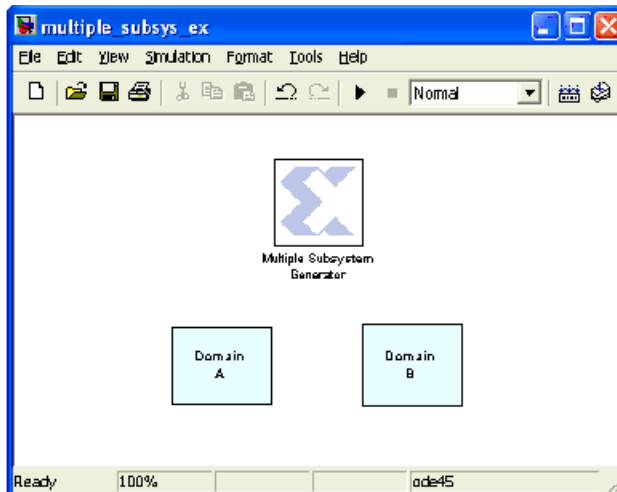

A subsystem that includes a master System Generator token is implemented using the NGC compilation target when the **Generate** button is pressed on the Multiple Subsystem Generator block. Using the NGC compilation target has the advantage of allowing the resulting HDL netlist, cores, and constraints to be delivered as a single netlist file. The HDL component that stitches the designs together instantiates the System Generator designs as black boxes; the NGC files provide the black box implementations. For the example shown above, three separate NGC files would be generated – one corresponding to each subsystem.

Before a design is generated, it is configured with the Part, Synthesis Tool, and Hardware Description Language parameters specified in the Multiple Subsystem Generator dialog box. These settings override the settings of the master System Generator tokens. Note that the original System Generator token settings are restored once generation is complete.

Subsystems that are wired together using the Multiple Subsystem Generator block can communicate with one another using a pair of Shared Memory blocks, To/From FIFO blocks, or To/From Register blocks. The block pairs must be partitioned so that one block resides in one subsystem (e.g., To FIFO block) while the other partner half resides in a different subsystem (e.g., From FIFO block).

When the complete design is translated into hardware, the two FIFO halves are pulled out of their respective subsystems. The System Generator logic that was previously attached to shared memory ports (e.g., data in, data out) are then wired to new top-level ports for that design. This means that one subsystem HDL component includes ports for one half of the shared memory, while the other half has ports for the other shared memory side. A hardware implementation of the shared memory is then created and wired to the top-level shared memory ports.

**Note:** The Multiple Subsystem Generator block does not currently support multiple shared memory blocks referencing the same shared memory object in the same subsystem. For example, a To FIFO block cannot be used to communicate to two From FIFO blocks placed in other subsystems.

Consider an example with two subsystems, A and B, where subsystem A contains a To FIFO block and subsystem B contains a From FIFO block. The opposing halves of the FIFO specify the same shared memory name, `my_fifo`. When the design is netlisted using the Multiple Subsystem Generator block, the To FIFO and From FIFO blocks are removed from their respective subsystems, and merged into a single core implementation (e.g., Asynchronous FIFO Core). This process is shown in the figure below.

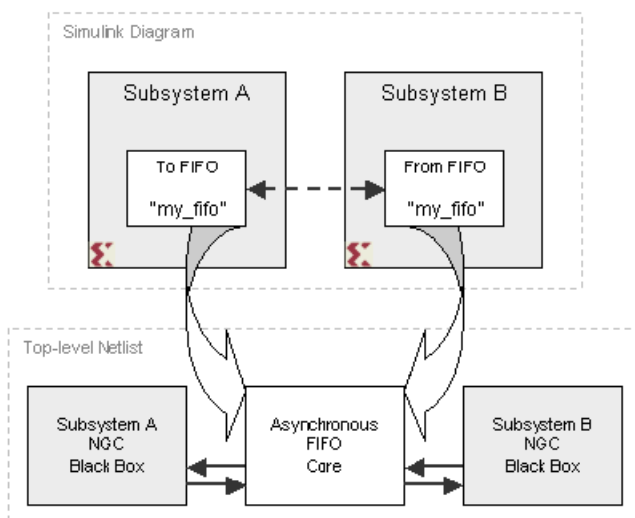

The table below provides the core or HDL component implementation that is used to implement shared memory and shared memory derivative blocks.

To Block	From Block	Hardware Implementation
Shared Memory	Shared Memory	Dual Port Block Memory
To FIFO	To FIFO	Fifo Generator
To Register	To Register	<code>synth_reg_w_init.(vhd,v)</code>

**Note:** Shared memory blocks should be used as the only means of communication between the subsystems. Do not use explicit System Generator signals to communicate between subsystems, as these are ultimately translated into top-level ports on the top-level HDL component that is created by the Multiple Subsystem Generator block.

All gateway ports included in the System Generator designs considered by the Multiple Subsystem Generator block are included in the top-level HDL component port interface. In addition, individual clock and clock enable ports are included in the port interface for each System Generator subsystem. The clock and clock enable port names are differentiated by the design name, which prefixes the port names. For example, assume the subsystem named `Domain A` has one input port named `inport_a` and one output port named `outport_a`. Also assume the subsystem named `Domain B` has one input port named `inport_b` and one output port named `outport_b`. The VHDL port interface for the resulting top-level entity is provided below:

```
entity multiple_subsys_ex is
port (
  domain_a_ce: in std_logic := '1';
  domain_a_clk: in std_logic;
```

```

domain_b_ce: in std_logic := '1';
domain_b_clk: in std_logic;
inport_a: in std_logic_vector(17 downto 0);
inport_b: in std_logic_vector(17 downto 0);
outport_a: out std_logic_vector(17 downto 0);
outport_b: out std_logic_vector(17 downto 0)
);
end multiple_subsys_ex;

```

## Multiple Clock Support

Because each subsystem considered by the Multiple Subsystem Generator block has a master System Generator token, it is possible to specify different clocking information (e.g., Simulink system period, FPGA clock period) in each block. By specifying different Simulink system periods, each System Generator design can run at a different rate during simulation, allowing you to effectively model systems that utilize asynchronous clock domains.

The Multiple Subsystem Generator creates a separate clock port for each subsystem that was generated. The clock ports are then routed to the corresponding clock port on the System Generator design. When a design that uses multiple clocks is netlisted (for example, translated from a high-level model into a lower level HDL description) the two shared memory halves are moved from their respective subsystems into the upper level of hierarchy. The two halves of the shared memory pair are then replaced with a single HDL component that implements the clock domain bridge (e.g., a dual-port memory). Clocks from the two domains are then connected to the opposing sides of the bridge component, along with the necessary data and control signals.

## Files Generated

The Multiple Subsystem Generator produces several low level files when the **Generate** button is pushed. These files are written to the target directory specified on the Multiple Subsystem Generator block dialog box. The key files produced by this block are defined in the following table:

File Name Type	Description
<design>.vhd (or .v)	Top-level HDL component that contains the System Generator designs stitched together.
.edn files	Besides writing HDL, the Multiple Subsystem Generator runs CORE Generator™ to implement shared memory hardware implementations. Coregen writes EDIF files whose names typically look something like multiplier_virtex2_6_0_83438798287b830b.edn.
globals	This file consists of key/value pairs that describe the design. The file is organized as a Perl hash table so that the keys and values can be made available to Perl scripts using Perl evals.
<design>.xcf (or .ncf)	This contains timing and port location constraints. These are used by the Xilinx synthesis tool XST and the Xilinx implementation tools. If the synthesis tool is set to something other than XST, then the suffix is changed to .ncf.

File Name Type	Description
hdlFiles	This tells full list of HDL files written by the Multiple Subsystem Generator block. The files are listed in the usual HDL dependency order.
<design>.npl	This allows the HDL and EDIF to be brought into the Xilinx project management tool Project Navigator.

# Mux

This block is listed in the following Xilinx Blockset libraries: *Basic Elements, Control Logic, Floating-Point and Index.*

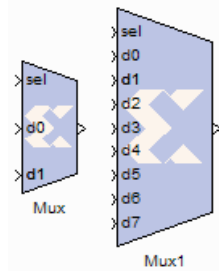

The Xilinx Mux block implements a multiplexer. The block has one select input (type unsigned) and a user-configurable number of data bus inputs, ranging from 2 to 1024.

## Block Parameters

The block parameters dialog box can be invoked by double-clicking the icon in your Simulink model.

### Basic tab

**Number of inputs:** specify a number between 2 and 32.

### Optional Ports

Other parameters used by this block are explained in the topic [Common Options in Block Parameter Dialog Boxes.](#)

### Output

#### Precision:

This parameter allows you to specify the output precision for fixed-point arithmetic. Floating point arithmetic output will always be **Full** precision.

- **Full:** The block uses sufficient precision to represent the result without error.
- **User Defined:** If you don't need full precision, this option allows you to specify a reduced number of total bits and/or fractional bits.

#### User-Defined Precision

##### Fixed-point Precision

- ◆ **Signed (2's comp):** The output is a Signed (2's complement) number.
- ◆ **Unsigned:** The output is an Unsigned number.
- ◆ **Number of bits:** specifies the bit location of the binary point of the output number where bit zero is the least significant bit.
- ◆ **Binary point:** position of the binary point. in the fixed-point output

### Quantization

Refer to the section [Overflow and Quantization](#).

### Overflow

Refer to the section [Overflow and Quantization](#).

Parameters used by this block are explained in the topic [Common Options in Block Parameter Dialog Boxes](#).

## LogiCORE™ Documentation

[LogiCORE IP Floating-Point Operator v6.1](#)

## Device Support

Floating-Point support is restricted to the following devices:

Virtex-7, Kintex-7, Artix-7, Zynq-7000, Virtex-6, Spartan-6

# Natural Logarithm

This block is listed in the following Xilinx Blockset libraries: AXI, Index and Math.



The Xilinx Natural Logarithm block produces the natural logarithm of the input.

## Block Parameters Dialog Box

### Basic tab

Parameters specific to the Basic tab are:

Flow Control Options

- **Blocking:** In this mode, the block waits for data on the input, as indicated by TREADY, which allows back-pressure.
- **NonBlocking:** In this mode, the block operates every cycle in which all inputs are valid, no back-pressure.

### Optional ports tab

Parameters specific to the Basic tab are:

Input Channel Ports:

- **Has TLAST:** Adds a tlast input port to the block.
- **Has TUSER:** Adds a tuser input port to the block.

Control Options:

- **Provide enable port:** Adds an enable port to the block interface.
- **Has Result TREADY:** Adds a TREADY port to the output channel.

Exception Signals:

- **INVALID\_OP:** Adds an output port that serves as an invalid operation flag.
- **DIVIDE\_BY\_ZERO:** Adds an output port that serves as a divide-by-zero flag.

## LogiCORE™ Documentation

[LogiCORE IP Floating-Point Operator v6.1](#)

## Device Support

Floating-Point support is restricted to the following devices:

Virtex-7, Kintex-7, Artix-7, Zynq-7000, Virtex-6, Spartan-6

## Negate

This block is listed in the following Xilinx Blockset libraries: *Floating-Point, Math and Index.*



The Xilinx Negate block computes the arithmetic negation of its input.

### Block Parameters

The block parameters dialog box can be invoked by double-clicking the icon in your Simulink model.

#### Basic tab

Parameters specific to the Basic tab are as follows:

##### Precision:

This parameter allows you to specify the output precision for fixed-point arithmetic. Floating point output always has **Full** precision.

- **Full:** The block uses sufficient precision to represent the result without error.
- **User Defined:** If you don't need full precision, this option allows you to specify a reduced number of total bits and/or fractional bits.

#### Fixed-Point Output Type

##### Arithmetic Type

- ◆ **Signed (2's comp):** The output is a Signed (2's complement) number.
- ◆ **Unsigned:** The output is an Unsigned number.

##### Fixed-point Precision

- ◆ **Number of bits:** Specifies the bit location of the binary point of the output number, where bit zero is the least significant bit.
- ◆ **Binary point:** Position of the binary point. in the fixed-point output

##### Quantization

Refer to the section [Overflow and Quantization](#).

##### Overflow

Refer to the section [Overflow and Quantization](#).

##### Optional Port

- Provide enable port

**Latency:** This defines the number of sample periods by which the block's output is delayed.

Parameters used by this block are explained in the topic [Common Options in Block Parameter Dialog Boxes](#).



## Network-based Ethernet Co-Simulation

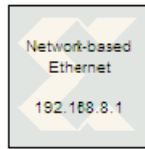

The Xilinx Network-based Ethernet Co-Simulation block provides an interface to perform hardware co-simulation through an Ethernet connection over the IPv4 network infrastructure.

Refer to [Network-Based Ethernet Hardware Co-Simulation](#) for further details about the interface, its prerequisites and setup procedures.

The port interface of the co-simulation block varies. When a model is implemented for network-based Ethernet hardware co-simulation, a new library is created that contains a custom network-based Ethernet co-simulation block with ports that match the gateway names (or port names if the subsystem is not the top level) from the original model. The co-simulation block interacts with the FPGA hardware platform during a Simulink simulation. Simulation data that is written to the input ports of the block are passed to the hardware by the block. Conversely, when data is read from the co-simulation block's output ports, the block reads the appropriate values from the hardware and drives them on the output ports so they can be interpreted in Simulink. In addition, the block automatically opens, configures, steps, and closes the platform.

### Block Parameters

The block parameters dialog box can be invoked by double-clicking the icon in your Simulink model.

#### Basic tab

Parameters specific to the Basic tab are as follows:

- **Clock source:** You can select between Single stepped and Free running clock sources. Selecting a Single stepped clock allows the block to step the board one clock cycle at a time. Each clock cycle step corresponds to some duration of time in Simulink. Using this clock source ensures the behavior of the co-simulation hardware during simulation is bit and cycle accurate when compared to the simulation behavior of the subsystem from which it originated. Sometimes single stepping is not necessary and the board can be run with a Free Running clock. In this case, the board will operate asynchronously to the Simulink simulation.
- **Has Combination Path:** Sometimes it is necessary to have a direct combinational feedback path from an output port on a hardware co-simulation block to an input port on the same block (e.g., a wire connecting an output port to an input port on a given block). If you require a direct feedback path from an output to input port, and your design does not include a combinational path from any input port to any output port, un-checking this box will allow the feedback path in the design.
- **Bitstream filename:** Specifies the co-simulation FPGA configuration file for the network-based Ethernet hardware co-simulation platform. When a new co-simulation block is created during compilation, this parameter is automatically set so that it points to the appropriate configuration file. You need only adjust this parameter if the location of the configuration file changes.

## Network tab

Parameters specific to the Network tab are as follows:

- **FPGA IP address:** Specify the IPv4 address associated with the target FPGA platform. The IP address must be specified using IPv4 dotted decimal notation (e.g. 192.168.8.1). For details on configuring the IP address, refer to the topic [Installing Your Hardware Co-Simulation Board](#).
- **Timeout:** Specifies the timeout value, in milliseconds, for packet retransmission in case of packet loss during the configuration and co-simulation process. The default value should suffice in the general case, but be advised that a larger value might be needed if the network connection is slow, with high latency, or congested.
- **Number of retries:** Specifies the number of retries for packet retransmission in case of packet loss during the configuration and co-simulation process. The default value should suffice in the general case, but be advised that a larger value might be needed if the network connection experiences a considerably amount of packet loss.

## See Also

[Ethernet Hardware Co-Simulation](#)

[Network-Based Ethernet Hardware Co-Simulation](#)

# Opmode

This block is listed in the following Xilinx Blockset libraries: *DSP and Index*.

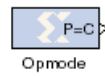

The Xilinx Opmode block generates a constant that is a DSP48A, DSP48, DS48E, or DSP48E1 instruction. The instruction is an 11-bit value for the DSP48, 8-bit for DSP48A, 15-bit value for the DSP48E and a 20-bit value for DSP48E1. The instruction can consist of the opmode, carry-in, carry-in select, inmode and either the subtract or alumode bits (depending upon the selection of DSP48 or DSP48E type).

The Opmode block is useful for generating DSP48A, DSP48, DS48E, or DSP48E1 control sequences. The figure below shows an example. The example implements a 35x35-bit multiplier using a sequence of four instructions in a DSP48 block. The opmode blocks supply the desired instructions to a multiplexer that selects each instruction in the desired sequence.

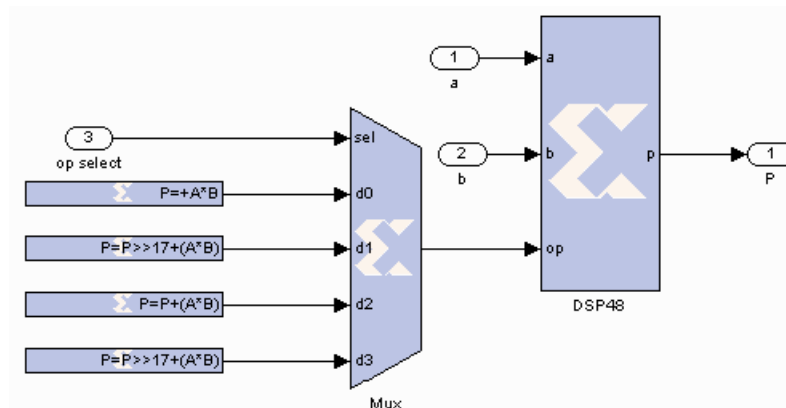

## Block Parameters

The block parameters dialog box can be invoked by double-clicking the icon in your Simulink model.

### Opmode tab

Parameters specific to the Opmode tab are as follows:

#### Instruction

- **Device:** specifies whether to generate an instruction for the DSP48A, DSP48, DSP48E, or DSP48E1 device.

#### DSP48 Instruction

- **Operation:** displays the instruction that is generated by the block (instruction is also displayed on the block).
- **Operation select:** selects the instruction.
- **Preadder output:** Allows you to select the equation for the DSP48E1 Preadder.
- **B register configuration:** Allows you to select the B register configuration for the DSP48E1. Select either B1 or B2.

### Custom Instruction

**Note:** The Custom Instruction field is activated when you select “Custom” in the **Operation select** field.

- **Instruction:** allows you to select the instruction for the DSP48A, DSP48, DS48E, or DSP48E1.
- **Z Mux:** specifies the 'Z' source to the add/sub/logic unit to be one of {'0', 'C', 'PCIN', 'P','C', 'PCIN>>17','P>>17'}.
- **Operand:** specifies whether the DSP48's adder is to perform addition or subtraction. In the DSP48E, the operand selection is made in the instruction pulldown.
- **XY Muxes:** specifies the 'XY' source to the DSP48's adder to be one of {'0','P', 'A:B', 'A\*B', 'C', 'P+C', 'A:B+C' }. 'A:B' implies that A is concatenated with B to produce a value to be used as an input to the add/sub/logic unit.
- **Carry Input:** specifies the 'carry' source to the DSP48's add/sub/logic unit to be one of {'0', '1', 'CIN', '~SIGN(P or PCIN)', '~SIGN(A:B or A\*B)', '~SIGND(A:B or A\*B)'}. '~SIGN (P or PCIN)' implies that the carry source is either P or PCIN depending on the Z Mux setting. '~SIGN(A\*B or A:B)' implies that the carry source is either A\*B or A:B depending on the YX Mux setting. The option '~SIGND (A\*B or A:B)' selects a delayed version of '~SIGN(A\*B or A:B)'.
- Other parameters used by this block are explained in the topic [Common Options in Block Parameter Dialog Boxes](#).

## Xilinx LogiCORE

The Opmode block does not use a Xilinx LogiCORE™.

## References

You should become familiar with the following DSP48 reference documents before using the Opmode block:

### DSP48A

[XtremeDSP DSP48A for Spartan-3A DSP FPGAs User Guide](#)

### DSP48

[XtremeDSP for Virtex-4 FPGAs User Guide](#)

### DSP48E

[Virtex-5 FPGA XtremeDSP Design Considerations User Guide](#)

### DSP48E1

[Virtex-6 FPGA DSP48E1 Slice User Guide](#)

## DSP48A Control Instruction Format

### DSP48A Instruction

Operation select	Notes
$C + A * B$	
$PCIN + A * B$	
$P + A * B$	
$A * B$	
$C + D:A:B$	
$C - D:A:B$	
C	
Custom	Use equation described in the Custom Instruction Field.

### DSP48A Custom Instruction

Custom Instruction Field	Location	Mnemonic	Notes
X Mux	op[3:0]	0	0
		P	DSP48 output register
		$A * B$	Multiplication of inputs A and B
		$A * (D + B)$	
		$A * (D - B)$	
		D:A:B	
		$D:A:(D + B)$	
		$D:A:(D - B)$	
Z Mux	op[6:4]	0	0
		PCIN	DSP48 cascaded input from PCOUT
		P	DSP48 output register
		C	DSP48 C input
Operand	op[7]	+	Add
		-	Subtract
Carry In	op[8]	0 or 1	Set carry in to 0 or 1
		CIN	Select cin as source

## DSP48 Control Instruction Format

### DSP48 Instruction

Operation select	Notes
$C + A * B$	
$PCIN + A * B$	
$P + A * B$	
$A * B$	
$C + A : B$	
$C - A : B$	
C	
Custom	Use equation described in the Custom Instruction Field.

### DSP48 Custom Instruction

Instruction Field Name	Location	Mnemonic	Notes
XY Mux	op[3:0]	0	0
		P	DSP48 output register
		A:B	Concat inputs A and B (A is MSB)
		$A * B$	Multiplication of inputs A and B
		C	DSP48 input C
		P+C	DSP48 input C plus P
		A:B+C	Concat inputs A and B plus C register
Z Mux	op[6:4]	0	0
		PCIN	DSP48 cascaded input from PCOUT
		P	DSP48 output register
		C	DSP48 C input
		$PCIN \gg 17$	Cascaded input downshifted by 17
		$P \gg 17$	DSP48 output register downshifted by 17
Operand	op[7]	+	Add
		-	Subtract

Instruction Field Name	Location	Mnemonic	Notes
Carry In	op[8]	0 or 1	Set carry in to 0 or 1
		CIN	Select cin as source
		'~SIGN(P or PCIN)	Symmetric round P or PCIN
		'~SIGN(A*B or A:B)	Symmetric round A:B or A*B
		'~SIGND(A*B or A:B)	Delayed symmetric round of A:B or A*B

## DSP48E Control Instruction Format

### DSP48E Instruction

Operation select	Notes
$C + A*B$	
$PCIN + A*B$	
$P + A*B$	
$A*B$	
$C + A:B$	
$C - A:B$	
C	
Custom	Use equation described in the Custom Instruction Field.

## DSP48E Custom Instruction

Instruction Field Name	Location	Mnemonic	Notes
XY muxes	op[3:0]	0	0
		P	DSP48 output register
		A:B	Concat inputs A and B (A is MSB)
		A*B	Multiplication of inputs A and B
		C	DSP48 input C
		P+C	DSP48 input C plus P
		A:B+C	Concat inputs A and B plus C register
Z mux	op[6:4]	0	0
		PCIN	DSP48 cascaded input from PCOUT
		P	DSP48 output register
		C	DSP48 C input
		PCIN>>17	Cascaded input downshifted by 17
		P>>17	DSP48 output register downshifted by 17
Alumode	op[10:7]	X+Z	Add
		Z-X	Subtract
Carry input	op[14:12]	0 or 1	Set carry in to 0 or 1
		CIN	Select cin as source. This adds a CIN port to the Opmode block whose value is inserted into the mnemonic at bit location 11.
		Round PCIN toward infinity	
		Round PCIN toward zero	
		Round P toward infinity	
		Round P toward zero	
		Larger add/sub/acc (parallel operation)	
		Larger add/sub/acc (sequential operation)	
		Round A*B	



## DSP48E1 Control Instruction Format

### DSP48E1 Instruction

Operation select	Notes
$C + A * B$	
$PCIN + A * B$	
$P + A * B$	
$A * B$	
$C + A : B$	
$C - A : B$	
C	
Custom	Use equation described in the Custom Instruction Field.

Preadder output	Notes
Zero	
A2	
A1	
$D + A2$	
$D + A1$	
D	
-A2	
-A1	
$D - A2$	
$D - A1$	

B register configuration	Notes
B1	
B2	

## DSP48E1 Custom Instruction

Instruction Field Name	Location	Mnemonic	Notes
Instruction		X + Z	
		X +NOT(Z)	
		NOT(X+Z)	
		Z - X	
		X XOR Z	
		X XNOR Z	
		X AND Z	
		X OR Z	
		X AND NOT(Z)	
		X OR NOT (Z)	
		X NAND Z	
		Z mux	op[6:4]
		PCIN	DSP48 cascaded input from PCOUT
		P	DSP48 output register
		C	DSP48 C input
		PCIN>>17	Cascaded input downshifted by 17
		P>>17	DSP48 output register downshifted by 17
Operand: (Alumode)	op[10:7]	X+Z	Add
		Z-X	Subtract
XY muxes	op[3:0]	0	0
		P	DSP48 output register
		A:B	Concat inputs A and B (A is MSB)
		A*B	Multiplication of inputs A and B
		C	DSP48 input C
		P+C	DSP48 input C plus P
		A:B+C	Concat inputs A and B plus C register
Carry input	op[14:12]	0 or 1	Set carry in to 0 or 1
		CIN	Select cin as source. This adds a CIN port to the Opmode block whose value is inserted into the mnemonic at bit location 11.
		Round PCIN toward infinity	

Instruction Field Name	Location	Mnemonic	Notes
		Round PCIN toward zero	
		Round P toward infinity	
		Round P toward zero	
		Larger add/sub/acc (parallel operation)	
		Larger add/sub/acc (sequential operation)	
		Round A*B	

## Parallel to Serial

This block is listed in the following Xilinx Blockset libraries: *Basic Elements, Data Types, and Index.*



The Parallel to Serial block takes an input word and splits it into N time-multiplexed output words where N is the ratio of number of input bits to output bits. The order of the output can be either least significant bit first or most significant bit first.

The following waveform illustrates the block's behavior:

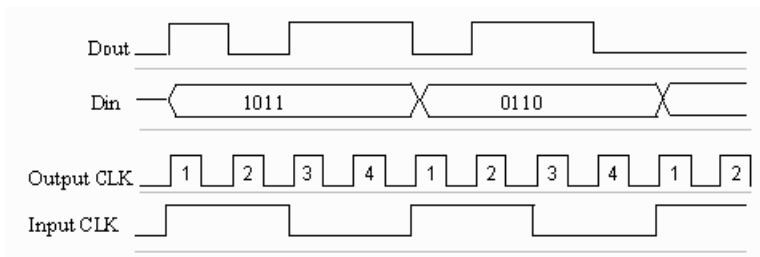

This example illustrates the case where the input width is 4, output word size is 1, and the block is configured to output the most significant word first.

### Block Interface

The Parallel to Serial block has one input and one output port. The input port can be any size. The output port size is indicated on the block parameters dialog box.

### Block Parameters

The block parameters dialog box can be invoked by double-clicking the icon in your Simulink model.

#### Basic tab

Parameters specific to the Basic tab are as follows:

- **Output order:** Most significant word first or least significant word first.
- **Type:** signed or unsigned.
- **Number of bits:** Output width. Must divide Number of Input Bits evenly.
- **Binary Point:** Binary point location.

The minimum latency of this block is 0.

Other parameters used by this block are explained in the topic [Common Options in Block Parameter Dialog Boxes](#).

## Pause Simulation

*This block is listed in the following Xilinx Blockset libraries: Tools and Index.*



The Xilinx Pause Simulation block pauses the simulation when the input is non-zero. The block accepts any Xilinx signal type as input.

When the simulation is paused, it can be restarted by selecting the **Start** button on the model toolbar. 

### Block Parameters

There are no parameters for this block.

## PicoBlaze Instruction Display

This block is listed in the following Xilinx Blockset libraries: *Tools and Index*.

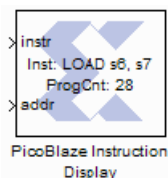

The PicoBlaze Instruction Display block takes an encoded 18-bit PicoBlaze instruction and a 10-bit address and displays the decoded instruction and the program counter on the block icon. This feature is useful when debugging PicoBlaze designs and can be used in conjunction with the [Single-Step Simulation](#) block to step through each instruction.

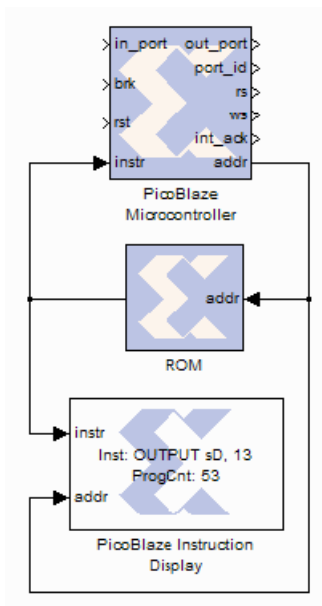

### Block Interface

The PicoBlaze Instruction Display block has two input ports. The `instr` port accepts an 18-bit encoded instruction. The `addr` port accepts a 10-bit address value which is the program counter.

### Block Parameters

The block parameters dialog box can be invoked by double-clicking the icon in your Simulink model.

Parameters specific to the block are as follows:

- **Version:** PicoBlaze 2 or PicoBlaze 3.
- **Disable Display:** When selected, the display is no longer updated which will speed up your simulation when not in debug mode.

### Xilinx LogiCORE

The PicoBlaze Instruction Display block does not use a Xilinx LogiCORE™.

## PicoBlaze Microcontroller

This block is listed in the following Xilinx Blockset libraries: *Control Logic and Index*.

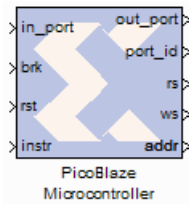

The Xilinx PicoBlaze Microcontroller block implements an embedded 8-bit microcontroller using the PicoBlaze macro.

The block supports Extended Spartan®-3 and Virtex®-5 FPGA. The block also supports Spartan-6 and Virtex-6. 7 Series devices are currently only supported by PicoBlaze 2.

The PicoBlaze 2 macro provides 49 instructions, 32 8-bit general-purpose registers, 256 directly and indirectly addressable ports, and a maskable interrupt. By comparison, the PicoBlaze 3 provides 53 instructions, 16 8-bit general-purpose registers, 256 directly and indirectly addressable ports, and a maskable interrupt, as well as 64 bytes of internal scratch pad memory accessible using the STORE and FETCH instructions. The PicoBlaze 3 embedded controller and its instruction set are described in detail in the PicoBlaze 8-bit Embedded Microcontroller User Guide, which can be found at:

[http://www.xilinx.com/support/documentation/ip\\_documentation/ug129.pdf](http://www.xilinx.com/support/documentation/ip_documentation/ug129.pdf).

Ordinarily, a single block ROM containing 1024 or fewer 18-bit words serves as the program store. The microcontroller and ROM are connected as shown below.

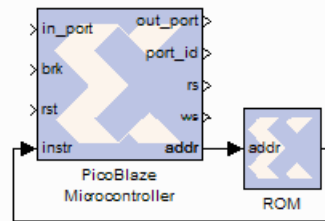

### Block Interface

Both versions of the block have four input ports. The 8-bit data port, `in_port`, is read during an INPUT operation. The value can be transferred into any of the 32 registers. The program can be interrupted by setting the port `brk` to 1. The processor can be reset by setting `rst` to 1. This clears registers and forces the processor to begin executing instructions at address 0. The 8-bit input port `instr` accepts PicoBlaze instructions.

The PicoBlaze 2 block has five output ports. The PicoBlaze 3 block has six output ports. The 8-bit output port `out_port` is written during an OUTPUT instruction. During a read/write, the `port_id` output identifies the location from which a value is read/written. The output ports `rs` (read strobe) and `ws` (write strobe) indicate whether a read (INPUT) or write (OUTPUT) operation is occurring. `addr` is the address of the next instruction to be executed by the processor. The processor has no internal program store. The output port `addr` specifies the next location from which an instruction should be executed. The `ack` port (PicoBlaze 3 only) indicates when the interrupt service routine is started (for example, the program counter is set to 0x3FF).

### Block Parameters

Parameters specific to the PicoBlaze Microcontroller block are:

- **Version:** PicoBlaze 2 or PicoBlaze 3.
- **Display Internal State:** When checked, the registers and control flags are made available in the MATLAB workspace. The information is present as a structure with the following naming convention:

```
< design name >_< subsystem name >_< PicoBlaze block name >.
```

The structure contains a field for each register (for example, s00,s01, etc.) and the control flags CARRY and ZERO.

- **Display Values As:** Tells the radix to use for displaying values.

Other parameters used by this block are explained in the topic

[Common Options in Block Parameter Dialog Boxes.](#)

## How to Use the PicoBlaze Assembler

**Note:** The Xilinx PicoBlaze Assembler is only available with the Windows Operating System. Third-party PicoBlaze Assemblers are available for Linux, but are not shipped by Xilinx.

1. Write a PicoBlaze program. Save the program with a .psm file extension.
2. Run the assembler from the MATLAB command prompt. The command is:

```
xlpb_as -p <your_psm_file>.
```

The default is to assemble a program for PicoBlaze 3. To assemble a program for PicoBlaze 2 use the `-v 2` option. This script runs the PicoBlaze assembler and generates a M-code program which should be used to populate the ROM or RAM used as the program store.

## Device Support

Virtex-7, Virtex-6, Virtex-5, Virtex-4, Virtex-II, Virtex-II Pro, Zynq-7000, Artix-7, Kintex-7, Spartan-6, Spartan-3A, Spartan-3AN, Spartan-3

## Known Issues

- The PicoBlaze assembler `xlpb_as` fails when the assembly code file is found in a directory whose full path name contains more than 58 characters.
- Verilog netlisting is not supported for this block.

## PicoBlaze Microprocessor Online Documentation

More information can be found at

[http://www.xilinx.com/ipcenter/processor\\_central/picoblaze/picoblaze\\_user\\_resources.htm](http://www.xilinx.com/ipcenter/processor_central/picoblaze/picoblaze_user_resources.htm).



## PicoBlaze6 Instruction Display

This block is listed in the following Xilinx Blockset libraries: *Tools and Index*.



The PicoBlaze6™ Instruction Display block takes an encoded 18-bit picoblaze6 instruction and PicoBlaze address output and displays the decoded instruction and the program counter on the block icon. This feature is useful when debugging PicoBlaze6 designs and can be used in conjunction with the [Single-Step Simulation](#) block to step through each instruction.

### Block Interface

The PicoBlaze6 Instruction Display block has two input ports. The **instr** port accepts an 18-bit encoded instruction. The **addr** port accepts a picoblaze6 (10-, 11-, or 12-bit) address value which is the program counter.

### Block Parameters

The block parameters dialog box can be invoked by double-clicking the icon in your Simulink model.

Parameters specific to the block are as follows:

- **Disable Display:** When selected, the display is no longer updated which will speed up your simulation when not in debug mode.

### Xilinx LogiCORE

The PicoBlaze6 Instruction Display block does not use a Xilinx LogiCORE™.

## PicoBlaze6 Microcontroller

This block is listed in the following Xilinx Blockset libraries: *Control Logic and Index*.

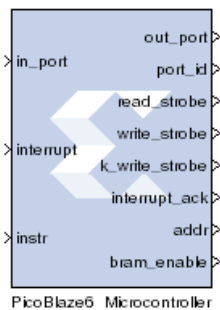

PicoBlaze6 Microcontroller

The Xilinx PicoBlaze6™ Microcontroller block implements an 8-bit microcontroller.

Applications requiring a complex, but non-time critical state machine as well as data processing applications are candidates to employ this block. The microcontroller is fully embedded into the device and requires no external support. Any additional logic can be connected to the microcontroller inside the device providing ultimate flexibility.

This block supports Spartan®-6, Virtex®-6 and 7-Series FPGAs. Some architecture highlights are:

- Predictable performance, two clock cycles per instruction
- 52 - 120 MIPS (dependent upon device type and speed grade)
- Fast interrupt response
- 26 slices, 0.5 to 2 block RAM (depend on device and program size)
- 32 8-bit general-purpose registers, divided in 2 banks which are independent of each other.
- Up to 256 byte internal RAM, configurable for 64,128 and 256 byte sizes.
- Internal 30-location CALL/RETURN stack, also detects for system underflow and overflow conditions
- 256 input and output ports supported

The Picoblaze 6 embedded controller and its instruction set are described in detail in the KCPSM6 user guide, which can be found at:

<http://www.xilinx.com/products/intellectual-property/picoblaze.htm>

Ordinarily, a single block ROM containing 4096 or fewer 18-bit words serves as the program store. The microcontroller and ROM are connected as shown in the image.

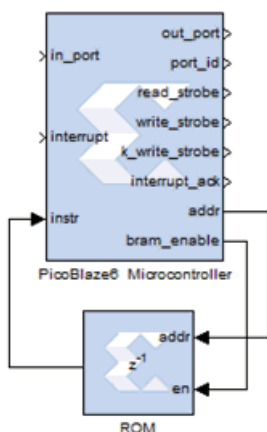

## Block Interface

Signal	Direction	Description
in_port[7:0]	Input	During an INPUT operation, data is transferred from the port to a register.
Interrupt	Input	Interrupt. Must be at least two clock cycles in duration.
instr[17:0]	Input	Instruction Input
rst	Input	Reset input. This is an optional port for sysgen simulation, but a required port in HDL. By default this is hidden and would be tied to ground in HDL generation. If user wishes to control this port it can be enabled through block configuration.
sleep	Input	Sleep pin, when driven high would put picoblaze6 in sleep mode, bram_enable signal would be low for the sleep period. This is a power saving feature of picoblaze6. This port is hidden by default and would be tied to ground in HDL generation. If user wishes to control this port, it can be enabled through block configuration.
out_port[7:0]	Output	Output Data Port
port_id[7:0]	Output	Port Address
read_strobe	Output	Read Strobe
write_strobe	Output	Write Strobe
k_write_strobe	Output	K write strobe, similar to write_strobe, is high for OUTPUTK instruction.
interrupt_ack	Output	Interrupt Acknowledge
addr[11:0]	Output	Address of the next instruction. This is configurable from block configuration. Accepted values are 1024 (addr[9:0]), 2048 (addr[10:0]) and 4096 (addr[11:0]) Please note same program instruction size should be set on bram block.
bram_enable	Output	This output signal indicates when bram block should be enabled for memory access. This is a power saving feature of picoblaze6

## Block Parameters

Parameters specific to the PicoBlaze6 Microcontroller block are:

- **Program Size:** accepted values are 1024, 2048 and 4096 instructions. Address pin width increases with increased program size.
- **Scratch Pad Size:** accepted values are 64, 128,256 bytes. This is passed as generic to generated HDL.
- **HW Build:** This is configurable 8 bit value which would be stored in the kcpsm6 and is configurable one time only. User may get the value in a register by using instruction HWBUILD. This is passed as generic to generated HDL.
- **Interrupt Vector Location:** Interrupt vector location where JUMP vector for interrupts is written. This is configurable to any location (upto program size)...however preferred value is nearly the end of program size to avoid any conflicts.
- **Provide reset Port:** This will expose reset port of the user, please note when reset port is exposed sysgen will shift to HDL simulation for the block, thus may give some performance degradation in simulation. Please use reset port only when required in design.
- **Provide sleep port:** This will expose sleep pin of picoblaze6 block. This is a power saving feature of picoblaze6.
- **Display Internal State:** When checked, the registers and control flags are made available in the MATLAB workspace. The information is present as a structure with the following naming convention:  
 < design name >\_< subsystem name >\_< PicoBlaze6 block name >\_reg.  
 The structure contains a field for each register (for example, BANKA\_s00, BANKA\_s01, etc.) and the control flags CARRY and ZERO.  
 < design name >\_< subsystem name >\_< PicoBlaze6 block name >\_mem  
 The structure contains value of all scratch pad locations, up to configured memory location.
- **Display Values As:** Specifies the radix to use for displaying values.
- Other parameters used by this block are explained in the topic [Common Options in Block Parameter Dialog Boxes](#).

## How to Use the PicoBlaze Assembler

**Note:** The Xilinx PicoBlaze6 Assembler is only available with the Windows Operating System. Third-party PicoBlaze6 Assemblers are available for Linux, but are not shipped by Xilinx.

1. Write a PicoBlaze6 program. Save the program with a .psm file extension.
2. Run the assembler from the MATLAB command prompt. The command is:

```
xlpb6_as -p <your_psm_file>
```

This script runs the PicoBlaze6 assembler and generates an M-code program which should be used to populate the ROM or RAM used as the program store.

## Device Support

### Supported

Virtex-7, Virtex-6, Virtex-5, Virtex-4, Virtex-II, Virtex-II Pro, Zynq-7000, Artix-7, Kintex-7, Spartan-6, Spartan-3A, Spartan-3AN, Spartan-3

## PicoBlaze6 Microprocessor Online Documentation

More information can be found at:

<http://www.xilinx.com/products/intellectual-property/picoblaze.htm>

## Point-to-point Ethernet Co-Simulation

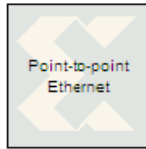

The Xilinx Point-to-point Ethernet Co-Simulation block provides an interface to perform hardware co-simulation through a raw Ethernet connection.

Refer to the topic [Ethernet Hardware Co-Simulation](#) for further details about the interface, its prerequisites and setup procedures.

A new Point-to-point Ethernet co-simulation block is created by selecting "Point-to-point Ethernet Cosim" as the compilation target in a System Generator token. The resulting block will have ports corresponding to the original gateways (or subsystem ports). The generated block can then be used just like any other Sysgen block. The co-simulation block interacts with the FPGA hardware platform during a Simulink simulation. Simulation data written to the input ports of the block passes to the hardware using the block. Conversely, when data is read from the co-simulation block's output ports, the block reads the appropriate values from the hardware and drives them on the output ports so they can be interpreted in Simulink. In addition, the block automatically opens, configures, steps, and closes the platform.

### Block Parameters

The block parameters dialog box can be invoked by double-clicking the icon in your Simulink model.

#### Basic tab

Parameters specific to the Basic tab are as follows:

- **Clock source:** You can select between Single stepped and Free running clock sources. Selecting a Single stepped clock allows the block to step the board one clock cycle at a time. Each clock cycle step corresponds to some duration of time in Simulink. Using this clock source ensures the behavior of the co-simulation hardware during simulation is bit and cycle accurate when compared to the simulation behavior of the subsystem from which it originated. Sometimes single stepping is not necessary and the board can be run with a Free Running clock. In this case, the board will operate asynchronously to the Simulink simulation.
- **Has Combination Path:** Sometimes it is necessary to have a direct combinational feedback path from an output port on a hardware co-simulation block to an input port on the same block (e.g., a wire connecting an output port to an input port on a given block). If you require a direct feedback path from an output to input port, and your design does not include a combinational path from any input port to any output port, un-checking this box will allow the feedback path in the design.
- **Bitstream filename:** Specifies the co-simulation FPGA configuration file for the Point-to-point Ethernet hardware co-simulation platform. When a new co-simulation block is created during compilation, this parameter is automatically set so that it points to the appropriate configuration file. You need only adjust this parameter if the location of the configuration file changes.

#### Ethernet tab

Parameters specific to the Ethernet tab are as follows:

- **Host interface:** Specifies the host network interface card that is used to establish a connection to the target FPGA platform for co-simulation. The pop-down list shows all active network interface cards that can be used for point-to-point Ethernet co-simulation. The information panel displays the MAC address, link speed, maximum frame size of the chosen interface, and its corresponding connection name in the Windows environment. The list of available

interfaces and the information panel might not reflect the up-to-date status, and in such case, they can be updated by clicking **Refresh** button.

- **FPGA interface MAC address:** Specifies the Ethernet MAC address associated with the target FPGA platform. The MAC address must be specified using six pairs of two-digit hexadecimal number separated by colons (e.g. 00:0a:35:11:22:33). For JTAG-based configuration, the MAC address can be arbitrarily assigned to each FPGA platform provided there is no conflicting address in the Ethernet LAN. For configuration over the point-to-point Ethernet connection, refer to Configuration using System ACE™ for details on configuring the MAC address of the FPGA platform. This field might be automatically populated if System Generator can detect the MAC address of a connected target platform.

## Configuration tab

Parameters specific to the Configuration tab are as follows:

### Cable

- **Type** Select one of the following: **Auto Detect**, **Xilinx Parallel Cable IV**, **Xilinx Platform USB**, **Xilinx Point-to-point Ethernet**, **Custom**. When **Auto Detect** is selected, Point-to-point co-simulation automatically scans through different JTAG cables (LPT1-LPT4, USB21-USB216) and picks the first FPGA device that matches what the design is targeted for.

Similarly, you can select **Xilinx Parallel Cable IV**, **Xilinx Platform USB**, or **Custom** to use the different JTAG configuration cables. If you want to configure the FPGA over the same point-to-point Ethernet connection, you can choose the **Xilinx Point-to-point Ethernet** option.

- **Speed** Shows the speed of the selected cable.
- **Port** Shows the port name of the selected cable.
- **Blink Cable LED** When Xilinx Platform USB is selected, you can click on this button to activate a blinking light next to the cable connector on the hardware board.
- **Plug-in Parameters** Specify the plug-in parameters for a **Custom** cable. This field uses the same syntax as that used by ChipScope/iMPACT.

<plugin> <param1>=<value1> <param2>=<value2>

For example, see the figure below:

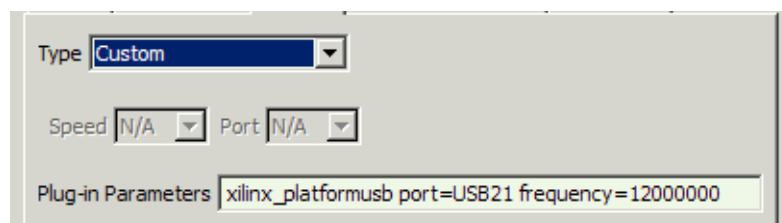

Refer to the ChipScope/iMPACT user documentation for further details on the cable plugin parameters.

**Configuration timeout (ms)** Specifies the time (in milliseconds) when a timeout condition occurs during the FPGA configuration process.

## Shared Memories tab

Displays the names of the shared memories that are detected in the design to be simulated.

## Software tab

Parameters specific to the Network tab are as follows:

- **Enable Co-Debug with Xilinx SDK (Beta):** On by default, clicking this item off disables the SDK Co-Debug feature in Sysgen

### Xilinx Software Development Kit (SDK)

- **Workspace:** Specifies the pathname to the SDK workspace when SDK is started from Sysgen using the Launch Xilinx SDK button.
- **Launch Xilinx SDK:** Starts Xilinx SDK for use in a Sysgen/SDK Co-Debug session

### Software Initialization

- **ELF file:** Specifies the pathname to the SDK project ELF file.
- **BMM file:** Specifies the pathname to the SDK project BMM file.

Other parameters used by this block are explained in the topic [Common Options in Block Parameter Dialog Boxes](#).

## See Also

[Ethernet Hardware Co-Simulation](#)

[Point-to-Point Ethernet Hardware Co-Simulation Configuration Using System ACE](#)



# Puncture

This block is listed in the following Xilinx Blockset libraries: *Communication and Index*.

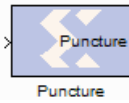

The Xilinx Puncture block removes a set of user-specified bits from the input words of its data stream.

Based on the puncture code parameter, a binary vector that specifies which bits to remove, it converts input data of type  $U\text{Fix}N\_0$  (where  $N$  is equal to the length of the puncture code) into output data of type  $U\text{Fix}K\_0$  (where  $K$  is equal to the number of ones in the puncture code). The output rate is identical to the input rate.

This block is commonly used in conjunction with a convolution encoder to implement punctured convolution codes as shown in the figure below.

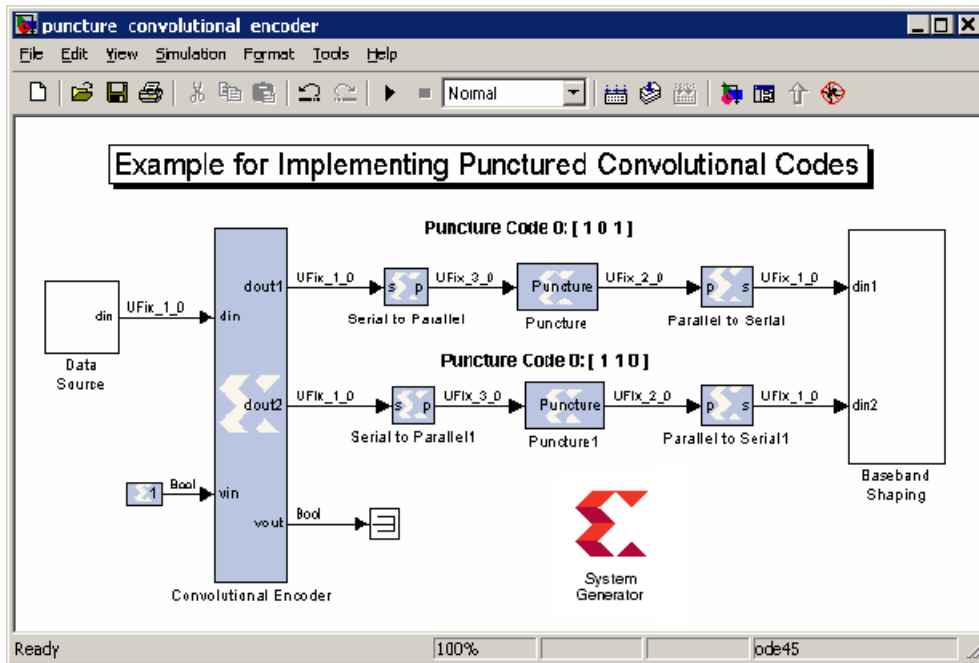

The system shown implements a rate  $\frac{1}{2}$  convolution encoder whose outputs are punctured to produce four output bits for each three input bits. The top puncture block removes the center bit for code 0 ( [ 1 0 1 ] ) and bottom puncture block removes the least significant bit for code 1 ( [ 1 1 0 ] ), producing a 2-bit punctured output. These data streams are serialized into 1-bit in-phase and quadrature data streams for baseband shaping.

## Block Parameters

The block parameters dialog box can be invoked by double-clicking the icon in your Simulink model.

Parameters specific to the block are as follows:

- **Puncture Code:** the puncture pattern represented as a bit vector, where a zero in position  $i$  indicates bit  $i$  is to be removed.

Other parameters used by this block are explained in the topic [Common Options in Block Parameter Dialog Boxes](#).

## Reciprocal

This block is listed in the following Xilinx Blockset libraries: *Floating-Point, Math and Index.*



The Xilinx Reciprocal block performs the reciprocal on the input. Currently, only the floating-point data type is supported.

### Block Parameters

The block parameters dialog box can be invoked by double-clicking the icon in your Simulink model.

#### Basic tab

Parameters specific to the Basic tab are as follows:

Flow Control:

- **Blocking:** Selects “Blocking” mode. In this mode, the lack of data on one input channel does block the execution of an operation if data is received on another input channel.
- **NonBlocking:** Selects “Non-Blocking” mode. In this mode, the lack of data on one input channel does not block the execution of an operation if data is received on another input channel.

#### Optional ports

Input Channel Ports

- **Has TLAST:** Adds a TLAST port to the Input channel.
- **Has TUSER:** Adds a TUSER port to the Input channel.
- **Provide enable port:** Adds an enable port to the block interface.
- **Has Result TREADY:** Adds a TREADY port to the Result channel.

Exception Signals

**UNDERFLOW:** Adds an output port that serves as an underflow flag.

**DIVIDE\_BY\_ZERO:** Adds an output port that serves as a divide-by-zero flag.

### LogiCORE™ Documentation

[LogiCORE IP Floating-Point Operator v6.1](#)

### Device Support

Floating-Point support is restricted to the following devices:

Virtex-7, Kintex-7, Artix-7, Zynq-7000, Virtex-6, Spartan-6

# Reciprocal SquareRoot

This block is listed in the following Xilinx Blockset libraries: *Floating-Point, Math and Index.*

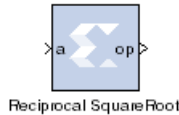

The Xilinx Reciprocal SquareRoot block performs the reciprocal squareroot on the input. Currently, only the floating-point data type is supported.

## Block Parameters

The block parameters dialog box can be invoked by double-clicking the icon in your Simulink model.

### Basic tab

Parameters specific to the Basic tab are as follows:

Flow Control:

- **Blocking:** Selects “Blocking” mode. In this mode, the lack of data on one input channel does block the execution of an operation if data is received on another input channel.
- **NonBlocking:** Selects “Non-Blocking” mode. In this mode, the lack of data on one input channel does not block the execution of an operation if data is received on another input channel.

### Optional ports

Input Channel Ports

- **Has TLAST:** Adds a TLAST port to the Input channel.
- **Has TUSER:** Adds a TUSER port to the Input channel.
- **Provide enable port:** Adds an enable port to the block interface.
- **Has Result TREADY:** Adds a TREADY port to the Result channel.

Exception Signals

**INVALID\_OP:** Adds an output port that serves as an invalid operation flag.

**DIVIDE\_BY\_ZERO:** Adds an output port that serves as a divide-by-zero flag.

Other parameters used by this block are explained in the topic [Common Options in Block Parameter Dialog Boxes](#).

## LogiCORE™ Documentation

[LogiCORE IP Floating-Point Operator v6.1](#)

## Device Support

Floating-Point support is restricted to the following devices:

Virtex-7, Kintex-7, Artix-7, Zynq-7000, Virtex-6, Spartan-6

## Reed-Solomon Decoder 7.1

This block is listed in the following Xilinx Blockset libraries: *Communication and Index*.

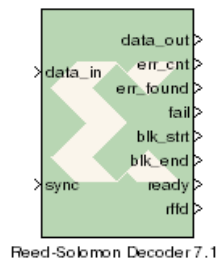

Reed-Solomon Decoder 7.1

The Reed-Solomon (RS) codes are block-based error correcting codes with a wide range of applications in digital communications and storage.

They are used to correct errors in many systems such as digital storage devices, wireless/ mobile communications, and digital video broadcasting.

The Reed-Solomon decoder processes blocks generated by a Reed-Solomon encoder, attempting to correct errors and recover information symbols. The number and type of errors that can be corrected depend on the characteristics of the code.

Reed-Solomon codes are Bose-Chaudhuri-Hocquenghem (BCH) codes, which in turn are linear block codes. An  $(n,k)$  linear block code is a  $k$ -dimensional sub-space of an  $n$ -dimensional vector space over a finite field. Elements of the field are called *symbols*. For a Reed-Solomon code,  $n$  ordinarily is  $2^s - 1$ , where  $s$  is the width in bits of each symbol. When the code is *shortened*,  $n$  is smaller. The decoder handles both full length and shortened codes. It is also able to handle *erasures*, that is, symbols that are known with high probability to contain errors.

When the decoder processes a block, there are three possibilities:

1. The information symbols are recovered. This is the case provided  $2p+r \leq n-k$ , where  $p$  is the number of errors and  $r$  is the number of erasures.
2. The decoder reports it is unable to recover the information symbols.
3. The decoder fails to recover the information symbols but does not report an error.

The probability of each possibility depends on the code and the nature of the communications channel. Simulink provides excellent tools for modeling channels and estimating these probabilities.

### Block Interface

The Xilinx RS Decoder block has inputs `data_in`, `sync` and `reset` and outputs `data_out`, `blk_strt`, `blk_end`, `err_found`, `err_cnt`, `fail`, `ready` and `rfd`. It also has optional inputs `n_in`, `erase`, `rst`, and `en`, and optional output ports `erase_cnt` and `data_del`.

The following describes these ports in detail:

- **data\_in**: presents blocks of  $n$  symbols to be decoded. The `din` signal must have type `UFIX_s_0`, where  $s$  is the width in bits of each symbol.
- **sync**: tells the decoder when to begin processing symbols from `data_in`. The decoder discards input symbols until the first time `sync` is asserted. The symbol on which `sync` is asserted marks the beginning of the first  $n$  symbol block to be processed by the decoder. The `sync` signal is ignored till the decoder is ready to accept another code block. The signal driving `sync` must be `Bool`.
- **erase**: indicates the symbol currently presented on `din` should be treated as an erasure. The signal driving `erase` must be `Bool`.
- **n\_in**: `n_in` is sampled at the start of each block. The new block's length, `n_block`, is set to `n_in` sampled. The `n_in` signal must have type `UFIX_s_0`, where  $s$  is the width in bits of each symbol. Added to the block when you select **Variable Block Length**.
- **rst**: resets the decoder. This port is added to the block when you specify **Synchronous Reset**. The signal driving `rst` must be `Bool`.

**Note:** `reset` must be asserted high for at least 1 sample period before the decoder can start decoding code symbols.

- **en**: carries the clock enable signal for the decoder. The signal driving `en` must be `Bool`. Added to the block when you select the optional pin **Clock Enable**.
- **data\_out**: produces the information and parity symbols resulting from decoding. The type of `data_out` is the same as that for `data_in`.
- **blk\_strt**: presents a 1 at the time `data_out` presents the first symbol of the block. `blk_strt` produces a signal of `UFIX_1_0` type.
- **blk\_end**: presents a 0 at the time `data_out` presents the last symbol of the block. `blk_end` produces a signal of `UFIX_1_0` type.
- **err\_found**: presents a value at the time `data_out` presents the last symbol of the block. The value is 1 if the decoder detected any errors or erasures during decoding. `err_found` must have type `UFIX_1_0`.
- **err\_cnt**: presents a value at the time `data_out` presents the last symbol of the block. The value is the number of errors that were corrected. `err_cnt` must have type `UFIX_b_0` where `b` is the number of bits needed to represent `n-k`.
- **fail**: presents a value at the time `dout` presents the last symbol of the block. The value is 1 if the decoder was unable to recover the information symbols, and 0 otherwise. `fail` must have type `UFIX_1_0`.
- **ready**: value is 1 when the decoder is ready to sample `data_in` input, and 0 otherwise. `ready` must have type `UFIX_1_0`.
- **rffd**: value is 1 when the decoder is ready to sample the first symbol of a code block on `data_in` input, and 0 otherwise. `rffd` must have type `UFIX_1_0`.
- **info\_end**: signals the last information symbol of the block on `data_out`.
- **data\_del**: produces the un-decoded symbols alongside the decoded symbols on `data_out`. The type of `data_del` is the same as that for `data_in`.
- **erase\_cnt**: only available when erasure decoding is enabled. Presents a value at the time `dout` presents the last symbol of the block. The value is the number of erasures that were corrected. `erase_cnt` must have type `UFIX_b_0` where `b` is the number of bits needed to represent `n`.
- **bit\_err\_0\_to\_1**: Number of bits received as 0 but corrected to 1.
- **bit\_err\_1\_to\_0**: Number of bits received as 1 but corrected to 0.
- **bit\_err\_rdy**: Signals that `bit_err_0_to_1` and `bit_err_1_to_0` is valid.
- **mark\_in**: Marker bits for tagging `data_in`.
- **mark\_out**: `mark_in` delayed by the block latency.

## Block Parameters

The block parameters dialog box can be invoked by double-clicking the icon in your Simulink model.

### Attributes 1 tab

Parameters specific to the Basic tab are as follows:

#### Code Block Specification

- **Code specification**: specifies the type of RS Decoder desired. The choices are:
  - ◆ **Custom**: allows you to set all the block parameters.
  - ◆ **DVB**: implements DVB (Digital Video Broadcasting) standard (204, 188) shortened RS code.

- ◆ **ATSC**: implements ATSC (Advanced Television Systems Committee) standard (207, 187) shortened RS code.
- ◆ **CCSDS**: implements CCSDS (Consultative Committee for Space Data Systems) standard (255, 223) full length RS code.
- ◆ **IESS-308 (All)**: implements IESS-308 (INTELSAT Earth Station Standard) specification (all) shortened RS code.
- ◆ **IESS-308 (126)**: implements IESS-308 (INTELSAT Earth Station Standard) specification (126, 112) shortened RS code.
- ◆ **IESS-308 (194)**: implements IESS-308 specification (194, 178) shortened RS code.
- ◆ **IESS-308 (208)**: implements IESS-308 specification (208, 192) shortened RS code.
- ◆ **IESS-308 (219)**: implements IESS-308 specification (219, 201) shortened RS code.
- ◆ **IESS-308 (225)**: implements IESS-308 specification (225, 205) shortened RS code.
- ◆ **IEEE-802.16d**: implements IEEE-802.16d specification (255, 239) full length RS code.
- **Symbol width**: tells the width in bits for symbols in the code. The encoder support widths from 3 to 12.
- **Field polynomial**: specifies the polynomial from which the symbol field is derived. It must be specified as a decimal number. This polynomial must be primitive. A value of zero indicates the default polynomial should be used. Default polynomials are listed in the table below.

Symbol Width	Default Polynomials	Array Representation
3	$x^3 + x + 1$	11
4	$x^4 + x + 1$	19
5	$x^5 + x^2 + 1$	37
6	$x^6 + x + 1$	67
7	$x^7 + x^3 + 1$	137
8	$x^8 + x^4 + x^3 + x^2 + 1$	285
9	$x^9 + x^4 + 1$	529
10	$x^{10} + x^3 + 1$	1033
11	$x^{11} + x^2 + 1$	2053
12	$x^{12} + x^6 + x^4 + x + 1$	4179

- **Scaling Factor (h)**: (represented in the previous formula as h) specifies the scaling factor for the code. Ordinarily, h is 1, but can be as large as  $2^S - 1$  where s is the symbol width. The value must be chosen so that  $\alpha^h$  is primitive. That is, h must be relatively prime to  $2^S - 1$ .
- **Generator Start**: specifies the first root r of the generator polynomial. The generator polynomial g(x), is given by:

$$g(x) = \prod_{j=0}^{n-k-1} (x - \alpha^{h(r+j)})$$

where  $\alpha$  is a primitive element of the symbol field, and the scaling factor is described below.

- **Variable Block Length**: when checked, the block is given a `n_in` input.

- **Symbols Per Block(n)**: tells the number of symbols in the blocks the encoder produces. Acceptable numbers range from 3 to  $2^S - 1$ , where  $s$  denotes the symbol width.
- **Data Symbols(k)**: tells the number of information symbols each block contains. Acceptable values range from  $\max(n - 256, 1)$  to  $n - 2$ .

#### Variable Check Symbol Options

- **Variable Number of Check Symbols (r)**:
- **Define Supported R\_IN Values**

If only a subset of the possible values that could be sampled on R\_IN is actually required, then it is possible to reduce the size of the core slightly. For example, for the Intelsat standard, the R\_IN input is 5 bits wide but only requires  $r$  values of 14, 16, 18, and 20. The core size can be slightly reduced by defining only these four values to be supported. If any other value is sampled on R\_IN, the core will not decode the data correctly.

- ◆ **Number of Supported R\_IN Values**: Specify the number of supported R\_IN values.
- ◆ **Supported R\_IN Definition File**: This is a COE file that defines the R values to be supported. It has the following format: `radix=10; legal_r_vector=14,16,18,20`; The number of elements in the `legal_r_vector` must equal the specified **Number of Supported R\_IN Values**.

### Attributes 2 tab

#### Implementation

- **Optimization**: choose between **Area** and **Speed** optimization.

#### State Machine

- ◆ **Self Recovering**: when checked, the block synchronously resets itself if it enters an illegal state.
- **Memory Style**: Select between **Distributed**, **Block** and **Automatic** memory choices.
- **Clocks Per Symbol**: specifies the number of sample periods to use per input data symbol. This can be increased to reduce the processing delay and support continuous decoding of code words. The input data should be held for the number of clock symbols specified.
- **Number Of Channels**: specifies the number of separate time division multiplexed channels to be processed by the encoder. The encoder supports up to 128 channels.

#### Puncture Options

- **Number of Puncture Patterns**: Specifies how many puncture patterns the LogiCORE needs to handle. It is set to 0 if puncturing is not required
- **Puncture Definition File**: Specifies the name of the puncture definition file that is used to define the puncture patterns.

### Optional pins tab

- **Info End**: Marks the last information symbol of a block on `data_out`.
- **Original Delayed Data**: when checked, the block is given a `data_del` output.
- **Erase**: when checked, the block is given an `erase` input.
- **Error Statistics**: Adds the following three error statistics outputs:
  - ◆ **bit\_err\_0\_to\_1**: Number of bits received as 1 but corrected to 0.
  - ◆ **bit\_err\_1\_to\_0**: Number of bits received as 0 but corrected to 1.
  - ◆ **bit\_err\_rdy**: Signals when `bit_err_0_to_1` and `bit_err_1_to_0` are valid.

- **Marker Bits:** Adds the following ports to the block:
  - ◆ **mark\_in:** Marker bits for tagging data\_in.
  - ◆ **mark\_out:** mark\_in delayed by the LogiCORE latency.
- **Number of Marker Bits:** Specifies the number of marker bits.

Other parameters used by this block are explained in the topic [Common Options in Block Parameter Dialog Boxes](#).

This is a licensed core, available for purchase on the Xilinx web site at:

[http://www.xilinx.com/xlnx/xebiz/designResources/ip\\_product\\_details.jsp?key=DO-DI-RSD](http://www.xilinx.com/xlnx/xebiz/designResources/ip_product_details.jsp?key=DO-DI-RSD).

## LogiCORE™ Documentation

[LogiCORE IP Reed-Solomon Decoder v7.1](#)

## Device Support

Virtex-7 and Kintex-7, Virtex-6, Virtex-5, Virtex-4  
Spartan-6, Spartan-3, Spartan-3E, Spartan-3A/3AN/3A DSP



## Reed-Solomon Decoder 8.0

This block is listed in the following Xilinx Blockset libraries: AXI4, Communication and Index.

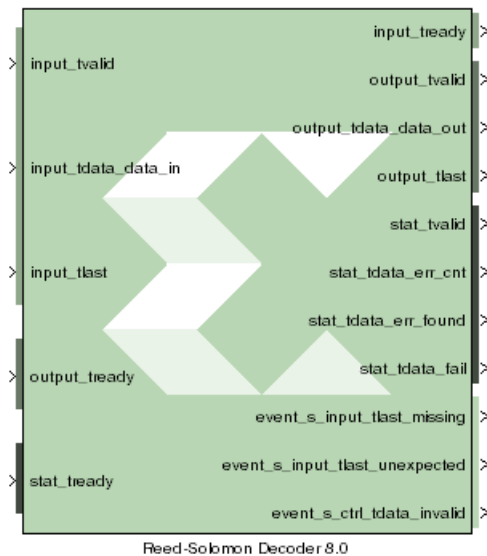

The Reed-Solomon (RS) codes are block-based error correcting codes with a wide range of applications in digital communications and storage.

They are used to correct errors in many systems such as digital storage devices, wireless/ mobile communications, and digital video broadcasting.

The Reed-Solomon decoder processes blocks generated by a Reed-Solomon encoder, attempting to correct errors and recover information symbols. The number and type of errors that can be corrected depend on the characteristics of the code.

Reed-Solomon codes are Bose-Chaudhuri-Hocquenghem (BCH) codes, which in turn are linear block codes. An  $(n,k)$  linear block code is a  $k$ -dimensional sub-space of an  $n$ -dimensional vector space over a finite field. Elements of the field are called *symbols*. For a Reed-Solomon code,  $n$

ordinarily is  $2^s - 1$ , where  $s$  is the width in bits of each symbol. When the code is *shortened*,  $n$  is smaller. The decoder handles both full length and shortened codes. It is also able to handle *erasures*, that is, symbols that are known with high probability to contain errors.

When the decoder processes a block, there are three possibilities:

1. The information symbols are recovered. This is the case provided  $2p+r \leq n-k$ , where  $p$  is the number of errors and  $r$  is the number of erasures.
2. The decoder reports it is unable to recover the information symbols.
3. The decoder fails to recover the information symbols but does not report an error.

The probability of each possibility depends on the code and the nature of the communications channel. Simulink provides excellent tools for modeling channels and estimating these probabilities.

### Block Interface Channels and Pins

The Xilinx Reed-Solomon Decoder 8.0 block is AXI4 compliant. The following describes the standard AXI channels and pins on the interface:

#### input Channel

- **input\_tvalid**: TVALID for the input channel.
- **input\_tdata\_erase**: indicates the symbol currently presented on `data_in` should be treated as an erasure. The signal driving this pin must be `Bool`.
- **input\_tdata\_data\_in**: presents blocks of  $n$  symbols to be decoded. This signal must have type `UFIX_s_0`, where  $s$  is the width in bits of each symbol.
- **input\_tlast**: Marks the last symbol of the input block. Only used to generate event outputs. Can be tied low or high if event outputs are not used.
- **input\_tready**: TREADY for the input channel.
- **input\_tuser\_mark\_in**: marker bits for tagging data on `data_in`. Added to the channel when you select **Marker Bits** from the Optional Pins tab.

## output Channel

- **output\_tready**: TREADY for the output channel.
- **output\_tvalid**: TVALID for the output channel.
- **output\_tdata\_data\_out**: produces the information and parity symbols resulting from decoding. The type of `data_out` is the same as that for `data_in`.
- **output\_tlast**: Goes high when the last symbol of the last block is on `tdata_data_out`. `output_tlast` produces a signal of type `UFIX_1_0`.
- **output\_tuser\_mark\_out**: `mark_in` tagging bits delayed by the latency of the LogiCORE. Added to the channel when you select **Marker Bits** on the Optional Pins tab.
- **output\_tdata\_info**: Added to the channel when you select **Info** on the Optional Pins tab. The signal marks the last information symbol of a block on `tdata_data_out`.
- **output\_tdata\_data\_del**: Added to the channel when you select **Original Delayed Data** on the Optional Pins tab. The signal marks the last information symbol of a block on `tdata_data_out`.

## stat Channel

- **stat\_tready**: TREADY for the stat channel.
- **stat\_tvalid**: TVALID for the stat channel. You should tie this signal high if the downstream slave is always able to accept data or if the stat channel is not used.
- **stat\_tdata\_err\_cnt**: presents a value at the time `data_out` presents the last symbol of the block. The value is the number of errors that were corrected. `err_cnt` must have type `UFIX_b_0` where `b` is the number of bits needed to represent `n-k`.
- **stat\_tdata\_err\_found**: presents a value at the time `output_tdata_data_out` presents the last symbol of the block. The value is 1 if the decoder detected any errors or erasures during decoding. `err_found` must have type `UFIX_1_0`.
- **stat\_tdata\_fail**: presents a value at the time `output_tdata_data_out` presents the last symbol of the block. The value is 1 if the decoder was unable to recover the information symbols, and 0 otherwise. This signal must be of type `UFIX_1_0`.
- **stat\_tdata\_erase\_cnt**: : only available when erasure decoding is enabled. Presents a value at the time `dout` presents the last symbol of the block. The value is the number of erasures that were corrected. This signal must be of type `UFIX_b_0` where `b` is the number of bits needed to represent `n`. Added to the channel when you select **Erase** from the Optional Pins tab.
- **stat\_tdata\_bit\_err\_1\_to\_0**: number of bits received as 1 but corrected to 0. Added to the channel when you select **Error Statistics** from the Optional Pins tab. The element width is the number of binary bits required to represent  $((n-k) * \text{Symbol\_Width})$ .
- **stat\_tdata\_bit\_err\_0\_to\_1**: number of bits received as 0 but corrected to 1. Added to the channel when you select **Error Statistics** from the Optional Pins tab. The element width is the number of binary bits required to represent  $((n-k) * \text{Symbol\_Width})$ .
- **stat\_tlast**: added when Number of Channels parameter is greater than 1. Indicates that status information for the last channel is present on `output_tdata`.

## event Channel

- **event\_s\_input\_tlast\_missing**: this output flag indicates that the `input_tlast` was not asserted when expected. You should leave this pin unconnected if it is not required.
- **event\_s\_input\_tlast\_unexpected**: this output flag indicates that the `input_tlast` was asserted when not expected. You should leave this pin unconnected if it is not required.

- **event\_s\_ctrl\_tdata\_invalid**: this output flag indicates that values provided on ctrl\_tdata were illegal. The block must be reset if this is asserted. You should leave this pin unconnected if it is not required.

### ctrl Channel

**Note:** This channel is only present when variable block length, number of check symbols or puncture is selected as a block parameter

- **ctrl\_tready**: TREADY for the ctrl channel.
- **ctrl\_tvalid**: TVALID for the ctrl channel.
- **ctrl\_tdata**: this input contains the block length, the number of check symbols and puncture select, if applicable.

### Other Optional Pins

- **aresetn**: resets the decoder. This pin is added to the block when you specify **Synchronous Reset** on the Optional Pins tab. The signal driving rst must be **BooL**.

**Note:** aresetn must be asserted high for at least 1 sample period before the decoder can start decoding code symbols.

- **acken**: carries the clock enable signal for the decoder. The signal driving acken must be **BooL**. Added to the block when you select the optional pin **Clock Enable**.

## Block Parameters

The block parameters dialog box can be invoked by double-clicking the icon in your Simulink model.

### Attributes 1 tab

Parameters specific to the Basic tab are as follows:

#### Code Block Specification

- **Code specification**: specifies the type of RS Decoder desired. The choices are:
  - ◆ **Custom**: allows you to set all the block parameters.
  - ◆ **DVB**: implements DVB (Digital Video Broadcasting) standard (204, 188) shortened RS code.
  - ◆ **ATSC**: implements ATSC (Advanced Television Systems Committee) standard (207, 187) shortened RS code.
  - ◆ **G.709**: implements G.709 Optical Transport Network standard.
  - ◆ **CCSDS**: implements CCSDS (Consultative Committee for Space Data Systems) standard (255, 223) full length RS code.
  - ◆ **IESS-308 (All)**: implements IESS-308 (INTELSAT Earth Station Standard) specification (all) shortened RS code.
  - ◆ **IESS-308 (126)**: implements IESS-308 (INTELSAT Earth Station Standard) specification (126, 112) shortened RS code.
  - ◆ **IESS-308 (194)**: implements IESS-308 specification (194, 178) shortened RS code.
  - ◆ **IESS-308 (208)**: implements IESS-308 specification (208, 192) shortened RS code.
  - ◆ **IESS-308 (219)**: implements IESS-308 specification (219, 201) shortened RS code.
  - ◆ **IESS-308 (225)**: implements IESS-308 specification (225, 205) shortened RS code.

- ◆ **IEEE-802.16d**: implements IEEE-802.16d specification (255, 239) full length RS code.
- **Symbol width**: tells the width in bits for symbols in the code. The encoder support widths from 3 to 12.
- **Field polynomial**: specifies the polynomial from which the symbol field is derived. It must be specified as a decimal number. This polynomial must be primitive. A value of zero indicates the default polynomial should be used. Default polynomials are listed in the table below.

Symbol Width	Default Polynomials	Array Representation
3	$x^3 + x + 1$	11
4	$x^4 + x + 1$	19
5	$x^5 + x^2 + 1$	37
6	$x^6 + x + 1$	67
7	$x^7 + x^3 + 1$	137
8	$x^8 + x^4 + x^3 + x^2 + 1$	285
9	$x^9 + x^4 + 1$	529
10	$x^{10} + x^3 + 1$	1033
11	$x^{11} + x^2 + 1$	2053
12	$x^{12} + x^6 + x^4 + x + 1$	4179

- **Scaling Factor (h)**: (represented in the previous formula as h) specifies the scaling factor for the code. Ordinarily, h is 1, but can be as large as  $2^S - 1$  where s is the symbol width. The value must be chosen so that  $\alpha^h$  is primitive. That is, h must be relatively prime to  $2^S - 1$ .
- **Generator Start**: specifies the first root r of the generator polynomial. The generator polynomial g(x), is given by:

$$g(x) = \prod_{j=0}^{n-k-1} (x - \alpha^{h(r+j)})$$

where  $\alpha$  is a primitive element of the symbol field, and the scaling factor is described below.

- **Variable Block Length**: when checked, the block is given a `ctrl` input channel.
- **Symbols Per Block(n)**: tells the number of symbols in the blocks the encoder produces. Acceptable numbers range from 3 to  $2^S - 1$ , where s denotes the symbol width.
- **Data Symbols(k)**: tells the number of information symbols each block contains. Acceptable values range from  $\max(n - 256, 1)$  to  $n - 2$ .

Variable Check Symbol Options

- **Variable Number of Check Symbols (r)**:
- **Define Supported R\_IN Values**

If only a subset of the possible values that could be sampled on R\_IN is actually required, then it is possible to reduce the size of the core slightly. For example, for the Intelsat standard, the R\_IN input is 5 bits wide but only requires r values of 14, 16, 18, and 20. The core size can be slightly reduced by defining only these four values to be supported. If any other value is sampled on R\_IN, the core will not decode the data correctly.

- ◆ **Number of Supported R\_IN Values**: Specify the number of supported R\_IN values.

- ◆ **Supported R\_IN Definition File:** This is a COE file that defines the R values to be supported. It has the following format: radix=10; legal\_r\_vector=14,16,18,20; The number of elements in the legal\_r\_vector must equal the specified **Number of Supported R\_IN Values**.

## Attributes 2 tab

### Implementation

#### State Machine

- ◆ **Self Recovering:** when checked, the block synchronously resets itself if it enters an illegal state.
- **Memory Style:** Select between **Distributed**, **Block** and **Automatic** memory choices.
- **Number Of Channels:** specifies the number of separate time division multiplexed channels to be processed by the encoder. The encoder supports up to 128 channels.
- **Output check symbols:** If selected, then the entire n symbols of each block are output on the output channel. If not selected, then only the k information symbols are output.

#### Puncture Options

- **Number of Puncture Patterns:** Specifies how many puncture patterns the LogiCORE needs to handle. It is set to 0 if puncturing is not required
- **Puncture Definition File:** Specifies the name of the puncture definition file that is used to define the puncture patterns.

## Optional pins tab

- **Clock Enable:** Adds a **acklen** pin to the block. This signal carries the clock enable and must be of type `Bool`.
- **Info:** Adds the **output\_tdata\_info** pin. Marks the last information symbol of a block on `tdata_data_out`.
- **Synchronous Reset:** Adds a **aresetn** pin to the block. This signal resets the block and must be of type `Bool`. The signal must be asserted for at least 2 clock cycles, however, it does not have to be asserted before the decoder can start decoding.
- **Original Delayed Data:** when checked, the block is given a `tdata_data_del` output. Indicates that a `DAT_DEL` field is in the `output_tdata` output.
- **Erase:** when checked, the block is given an `input_tdata_erase` input pin..
- **Error Statistics:** adds the following three error statistics outputs:
  - ◆ **bit\_err\_0\_to\_1:** number of bits received as 1 but corrected to 0.
  - ◆ **bit\_err\_1\_to\_0:** number of bits received as 0 but corrected to 1.
- **Marker Bits:** Adds the following pins to the block:
  - ◆ **input\_tuser\_mark\_in:** carries marker bits for tagging data on `input_tdata_data_in`.
  - ◆ **output\_tuser\_mark\_out:** mark\_in tagging bits delayed by the latency of the LogiCORE.
- **Number of Marker Bits:** specifies the number of marker bits.

Other parameters used by this block are explained in the topic [Common Options in Block Parameter Dialog Boxes](#).

This is a licensed core, available for purchase on the Xilinx web site at:

[http://www.xilinx.com/xlnx/xebiz/designResources/ip\\_product\\_details.jsp?key=DO-DI-RSD](http://www.xilinx.com/xlnx/xebiz/designResources/ip_product_details.jsp?key=DO-DI-RSD).

## LogiCORE™ Documentation

[LogiCORE IP Reed-Solomon Decoder v8.0](#)

## Device Support

**Pre-Production families are:**

Zynq-7000, Artix-7, Virtex-7, Kintex-7, Virtex-6, Spartan-6

# Reed-Solomon Encoder 7.1

This block is listed in the following Xilinx Blockset libraries: *Communications and Index*.

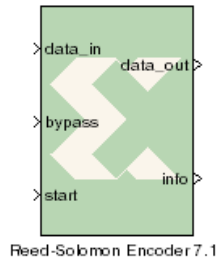

Reed-Solomon Encoder 7.1

The Reed-Solomon (RS) codes are block-based error correcting codes with a wide range of applications in digital communications and storage.

They are used to correct errors in many systems such as digital storage devices, wireless or mobile communications, and digital video broadcasting.

The Reed-Solomon encoder augments data blocks with redundant symbols so that errors introduced during transmission can be corrected. Errors can occur for a number of reasons (noise or interference, scratches on a CD, etc.). The Reed-Solomon decoder attempts to correct errors and recover the original data. The number and type of errors that can be corrected depends on the characteristics of the code.

A typical system is shown below:

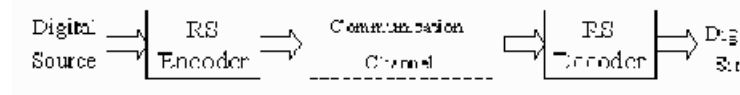

Reed-Solomon codes are Bose-Chaudhuri-Hocquenghem (BCH) codes, which in turn are linear block codes. An  $(n, k)$  linear block code is a  $k$ -dimensional sub space of an  $n$ -dimensional vector space over a finite field. Elements of the field are called symbols. For a Reed-Solomon code,  $n$  ordinarily is  $2^s - 1$ , where  $s$  is the width in bits of each symbol. When the code is shortened,  $n$  is smaller. The encoder handles both full length and shortened codes.

The encoder is systematic. This means it constructs code blocks of length  $n$  from information blocks of length  $k$  by adjoining  $n-k$  parity symbols.

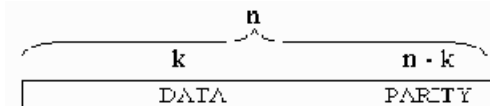

A Reed-Solomon code is characterized by its field and generator polynomials. The field polynomial is used to construct the symbol field, and the generator polynomial is used to calculate parity symbols. The encoder allows both polynomials to be configured. The generator polynomial has the form:

$$g(x) = (x - \alpha^j)(x - \alpha^{j+1}) \dots (x - \alpha^{j+n-k-1})$$

where  $\alpha$  is a primitive element of the finite field having  $n + 1$  elements.

## Block Interface

The Xilinx Reed-Solomon Encoder block has inputs `data_in`, `bypass`, and `start`, and outputs `data_out` and `info`. It also has optional inputs `n_in`, `r_in`, `nd`, `rst` and `en`. It also has optional outputs `rdy`, `rfd`, and `rffd`.

The following describes the ports in detail:

- data\_in**: presents blocks of symbols to be encoded. Each block consists of  $k$  information symbols followed by  $n - k$  un-interpreted filler symbols. The `din` signal must have type `UFIX_s_0`, where  $s$  is the width in bits of each symbol.

- **start**: tells the encoder when to begin processing symbols from `din`. The encoder discards input symbols until the first time `start` is asserted. The symbol on which `start` is asserted marks the beginning of the first `n` symbol blocks to be processed by the encoder. If `start` is asserted for more than one sample period, the value at the last period is taken as the beginning of the block. The `start` signal is ignored if `bypass` is asserted simultaneously. The signal driving `start` must be `Bool`.
- **bypass**: when `bypass` is asserted, the value on `din` is passed unchanged to `dout` with a delay of 4 (6 in the case of CCSDS) sample periods. The `bypass` signal has no effect on the state of the encoder. The signal driving `bypass` must be `Bool`.
- **n\_in**: This signal is used when the block size is variable. `n_in` is sampled at the start of each block. The new block's length, `n_block`, is set to `n_in` sampled. The `n_in` signal must have type `UFIX_s_0`, where `s` is the width in bits of each symbol.
- **r\_in**: This signal is used when the number of check symbols is variable. `r_in` is sampled at the start of each block. The new block's length, `r_block`, is set to `r_in` sampled. The `r_in` signal must have type `UFIX_p_0`, where `p` is the number of bits required to represent the parity bits (`n-k`) in the default code word.
- **nd**: marks each `data_in` symbol as part of the information symbols for processing parity symbols. The signal driving `nd` must be `Bool`.
- **rst**: carries the reset signal. The signal driving `rst` must be `Bool`.
- **en**: carries the enable signal. The signal driving `en` must be `Bool`.
- **data\_out**: produces blocks of `n` symbols that represent the results of encoding blocks of `k` information symbols read from `data_in`. The type of `data_out` is the same as that for `data_in`.
- **info**: equals 1 (respectively, 0) when the value presented on `data_out` is an information (respectively, parity) symbol. `info` must have type `UFIX_1_0`.
- **rdy**: marks each symbol produced on `data_out` as valid or invalid. `rdy` must have type `UFIX_1_0`.
- **rfd**: equals 1 when the encoder is accepting and producing information symbols, and is 0 when producing parity symbols. `rfd` must have type `UFIX_1_0`.
- **rffd**: equals 1 when the encoder is ready to accept a new `start` pulse. `rffd` must have type `UFIX_1_0`.



## Block Parameters

The block parameters dialog box can be invoked by double-clicking the icon in your Simulink model.

Parameters specific to the block are as follows:

### Attributes tab

#### Code Block Specification

- **Code specification:** specifies the encoder type. The choices are:
  - ◆ **Custom:** allows you to set all the block parameters.
  - ◆ **DVB:** implements DVB (Digital Video Broadcasting) standard (204, 188) shortened RS code.
  - ◆ **ATSC:** implements ATSC (Advanced Television Systems Committee) standard (207, 187) shortened RS code.
  - ◆ **G\_709:** implements the G.709 standard for communicating data over an optical network.
  - ◆ **ETSI\_BRAN:** implements the ETSI (European Telecommunication Standards Institute) standard for BRAN (Broadband Radio Access Networks).
  - ◆ **CCSDS:** implements CCSDS (Consultative Committee for Space Data Systems) standard (255, 223) full length RS code.
  - ◆ **ITU\_J\_83 Annex\_B:** implements ITU-J.83 Annex B specification (128, 122) extended RS code.
  - ◆ **IESS-308 (126):** implements IESS-308 (INTELSAT Earth Station Standard) specification (126, 112) shortened RS code.
  - ◆ **IESS-308 (194):** implements IESS-308 specification (194, 178) shortened RS code.
  - ◆ **IESS-308 (208):** implements IESS-308 specification (208, 192) shortened RS code.
  - ◆ **IESS-308 (219):** implements IESS-308 specification (219, 201) shortened RS code.
  - ◆ **IESS-308 (225):** implements IESS-308 specification (225, 205) shortened RS code.
- **Variable Number of Check Symbols (r):** when checked, the block is given an `r_in` and `n_in` input.
- **Variable Block Length:** when checked, the block is given a `n_in` input.
- **Symbol width:** tells the width in bits for symbols in the code. The encoder supports widths from 3 to 12.
- **Field polynomial:** specifies the polynomial from which the symbol field is derived. It must be specified as a decimal number. This polynomial must be primitive. A value of zero indicates the default polynomial should be used. Default polynomials are listed in the table below.

Symbol Width	Default Polynomials	Array Representation
3	$x^3 + x + 1$	11
4	$x^4 + x + 1$	19
5	$x^5 + x^2 + 1$	37
6	$x^6 + x + 1$	67
7	$x^7 + x^3 + 1$	137
8	$x^8 + x^4 + x^3 + x^2 + 1$	285

Symbol Width	Default Polynomials	Array Representation
9	$x^9 + x^4 + 1$	529
10	$x^{10} + x^3 + 1$	1033
11	$x^{11} + x^2 + 1$	2053
12	$x^{12} + x^6 + x^4 + x + 1$	4179

- **Scaling Factor (h):** specifies the scaling factor for the code. Ordinarily the scaling factor is 1, but can be as large as  $2^S - 1$  where s is the symbol width. The value must be chosen so that  $\alpha^h$  is primitive, for example, the value must be relatively prime to  $2^S - 1$ .
- **Generator start:** specifies the first root r of the generator polynomial. The generator polynomial g(x) is given by:

$$g(x) = \prod_{i=0}^{n-k-1} (x - \alpha^{h(r+i)})$$

- **Symbols Per Block (n):** specifies the number of symbols in the blocks the encoder produces. Acceptable numbers range from 3 to  $2^S - 1$ , where s denotes the symbol width.
- **Data Symbols (k):** specifies the number of information symbols each block contains. Acceptable values range from  $\max(n - 256, 1)$  to  $n - 2$ .

## Optional pins tab

### Implementation

- **Check Symbol Generator Optimization:** allows you to select between
  - ♦ **Fixed Architecture:** The check symbol generator is implemented using a highly efficient fixed architecture.
  - ♦ **Area.** The check symbol generator implementation is optimized for area and speed efficiency. The range of input, N\_IN, is reduced.
  - ♦ **Flexibility:** The check symbol generator implementation is optimized to maximize the range of input N\_IN.
- **Memory Style:** allows you to select between **Distributed**, **Block** and **Automatic** memory choices. This option is available only for CCSDS codes.
- **Number of Channels:** specifies the number of separate time division multiplexed channels to be processed by the encoder. The encoder supports up to 128 channels.

### Optional Pins

- **CE:** when checked, the block is given a ce (clock enable) input.
- **RDY:** when checked, the block is given a rdy (ready) output.
- **ND:** when checked, the block is given a nd (new data) input.
- **RFD:** when checked, the block is given a rfd (ready for data) output.
- **SCLR:** when checked, the block is given a sclr (synchronous clear) input.
- **RFFD:** when checked, the block is given a rffd (ready for first data) output.

Other parameters used by this block are explained in the topic

[Common Options in Block Parameter Dialog Boxes.](#)

This is a licensed core, available for purchase on the Xilinx web site at:

[http://www.xilinx.com/xlnx/xebiz/designResources/ip\\_product\\_details.jsp?key=DO-DI-RSE](http://www.xilinx.com/xlnx/xebiz/designResources/ip_product_details.jsp?key=DO-DI-RSE).

## LogiCORE™ Documentation

[LogiCORE IP Reed-Solomon Encoder v7.1](#)

## Device Support

Virtex-7 and Kintex-7, Virtex-6, Virtex-5, Virtex-4  
Spartan-6, Spartan-3, Spartan-3E, Spartan-3A/3AN/3A DSP

## Reed-Solomon Encoder 8.0

This block is listed in the following Xilinx Blockset libraries: AXI4, Communications and Index.

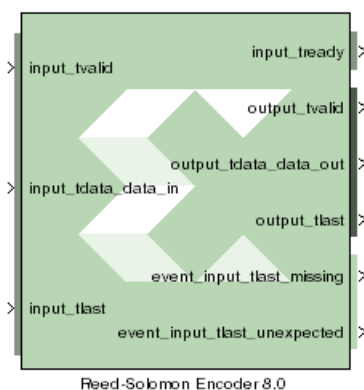

The Reed-Solomon (RS) codes are block-based error correcting codes with a wide range of applications in digital communications and storage. This block adheres to the AMBA® AXI4-Stream standard.

They are used to correct errors in many systems such as digital storage devices, wireless or mobile communications, and digital video broadcasting.

The Reed-Solomon encoder augments data blocks with redundant symbols so that errors introduced during transmission can be corrected. Errors can occur for a number of reasons (noise or interference, scratches on a CD, etc.). The Reed-Solomon decoder attempts to correct errors and recover

the original data. The number and type of errors that can be corrected depends on the characteristics of the code.

A typical system is shown below:

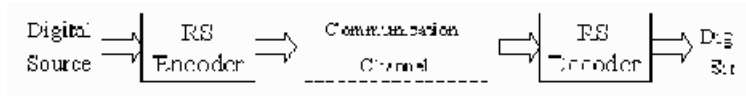

Reed-Solomon codes are Bose-Chaudhuri-Hocquenghem (BCH) codes, which in turn are linear block codes. An  $(n, k)$  linear block code is a  $k$ -dimensional sub space of an  $n$ -dimensional vector space over a finite field. Elements of the field are called symbols. For a Reed-Solomon code,  $n$  ordinarily is  $2^s - 1$ , where  $s$  is the width in bits of each symbol. When the code is shortened,  $n$  is smaller. The encoder handles both full length and shortened codes.

The encoder is systematic. This means it constructs code blocks of length  $n$  from information blocks of length  $k$  by adjoining  $n-k$  parity symbols.

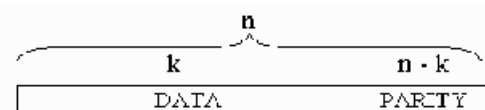

A Reed-Solomon code is characterized by its field and generator polynomials. The field polynomial is used to construct the symbol field, and the generator polynomial is used to calculate parity symbols. The encoder allows both polynomials to be configured. The generator polynomial has the form:

$$g(x) = (x - \alpha^j)(x - \alpha^{j+1}) \dots (x - \alpha^{j+n-k-1})$$

where  $\alpha$  is a primitive element of the finite field having  $n + 1$  elements.

## Block Interface Channels and Pins

The Xilinx Reed-Solomon Decoder 8.0 block is AXI4 compliant. The following describes the standard AXI channels and pins on the interface:

### input Channel

- **input\_tvalid**: TVALID for the input channel.
- **input\_tdata\_data\_in**: presents blocks of  $n$  symbols to be decoded. This signal must have type `UFIX_s_0`, where  $s$  is the width in bits of each symbol.
- **input\_tlast**: Marks the last symbol of the input block. Only used to generate event outputs. Can be tied low or high if event outputs are not used.
- **input\_tready**: TREADY for the input channel.
- **input\_tuser\_user**: marker bits for tagging data on `input_tdata_data_in`. Added to the channel when you select **Marker Bits** from the Detailed Implementation tab.

### output Channel

- **output\_tready**: TREADY for the output channel. Added to the channel when you select **Output TREADY** from the Optional Pins tab.
- **output\_tvalid**: TVALID for the output channel.
- **output\_tdata\_data\_out**: produces the information and parity symbols resulting from decoding. The type of `data_out` is the same as that for `data_in`.
- **output\_tlast**: Goes high when the last symbol of the last block is on `tdata_data_out`. `output_tlast` produces a signal of type `UFIX_1_0`.
- **output\_tuser\_tuser**: This pin is available when user selects "Marker Bits" from the Detailed Implementation tab.

### event Channel

- **event\_s\_input\_tlast\_missing**: this output flag indicates that the `input_tlast` was not asserted when expected. You should leave this pin unconnected if it is not required.
- **event\_s\_input\_tlast\_unexpected**: this output flag indicates that the `input_tlast` was asserted when not expected. You should leave this pin unconnected if it is not required.
- **event\_s\_ctrl\_tdata\_invalid**: this output flag indicates that values provided on `ctrl_tdata` were illegal. This pin is available when "Variable Block Length" or "Variable Number of Check Symbols" are selected on the GUI.

### ctrl Channel

*Note:* This channel is only present when variable block length or number of check symbols is selected as a block parameter

- **ctrl\_tvalid**: TVALID for the ctrl channel.
- **ctrl\_tdata\_n\_in**: This signal is only present if "Variable Block Length" is selected in the GUI. This allows the block length to be changed every block. The `ctrl_tdata_n_in` signal must have type `UFIX_s_0`, where  $s$  is the width in bits of each symbol. Unless there is an `R_IN` field, the number of check symbols is fixed, so varying  $n$  automatically varies  $k$ .
- **ctrl\_tdata\_n\_r**: This field is only present if "Variable Number of Check Symbols" is selected in the GUI. It allows the number of check symbols to be changed every block. The new block's length, `r_block`, is set to `ctrl_tdata_r_in` sampled. The `ctrl_tdata_r_in` signal must have type `UFIX_p_0`, where  $p$  is the number of bits required to represent the parity bits ( $n-k$ ) in the

default code word,  $n$  being the "Symbols Per Block" and  $k$  being "Data Symbols". Selecting this input significantly increases the size of the core.

## Other Optional Pins

- **aresetn**: resets the encoder. This pin is added to the block when you specify **ARESETn** on the Detailed Implementation tab. The signal driving **ARESETn** must be **Boo1**.  
*Note:* **aresetn** must be asserted low for at least 2 clock periods and at least 1 sample period before the decoder can start decoding code symbols.
- **aclken**: carries the clock enable signal for the encoder. The signal driving **aclken** must be **Boo1**. Added to the block when you select the optional pin **ACLKEN**.

## Block Parameters

The block parameters dialog box can be invoked by double-clicking the icon in your Simulink model.

### Attributes

Parameters specific to the Basic tab are as follows:

#### Code Block Specification

- **Code specification**: specifies the encoder type desired. The choices are:
  - ◆ **Custom**: allows you to set all the block parameters.
  - ◆ **DVB**: implements DVB (Digital Video Broadcasting) standard (204, 188) shortened RS code.
  - ◆ **ATSC**: implements ATSC (Advanced Television Systems Committee) standard (207, 187) shortened RS code.
  - ◆ **G\_709**: implements G.709 Optical Transport Network standard.
  - ◆ **ETSI\_BRAN**: implements the ETSI Project standard for Broadband Radio Access Networks (BRAN).
  - ◆ **CCSDS**: implements CCSDS (Consultative Committee for Space Data Systems) standard (255, 223) full length RS code.
  - ◆ **ITU\_J\_83\_Annex\_B**: implements International Telecommunication Union (ITU)-J.83 Annex B specification (128, 122) extended RS code.
  - ◆ **IESS-308 (All)**: implements IESS-308 (INTELSAT Earth Station Standard) specification (all) shortened RS code.
  - ◆ **IESS-308 (126)**: implements IESS-308 (INTELSAT Earth Station Standard) specification (126, 112) shortened RS code.
  - ◆ **IESS-308 (194)**: implements IESS-308 specification (194, 178) shortened RS code.
  - ◆ **IESS-308 (208)**: implements IESS-308 specification (208, 192) shortened RS code.
  - ◆ **IESS-308 (219)**: implements IESS-308 specification (219, 201) shortened RS code.
  - ◆ **IESS-308 (225)**: implements IESS-308 specification (225, 205) shortened RS code.
- **Variable Number of Check Symbols (r)**: false, true. When checked, the **ctrl\_tdata\_r\_in** and **ctrl\_tdata\_n\_in** pins become available on the block.
- **Variable Block Length**: false, true. When checked, the **ctrl\_tdata\_n\_in** pin becomes available on the block.

- **Symbol width:** tells the width in bits for symbols in the code. The encoder support widths from 3 to 12.
- **Field polynomial:** specifies the polynomial from which the symbol field is derived. It must be specified as a decimal number. This polynomial must be primitive. A value of zero indicates the default polynomial should be used. Default polynomials are listed in the table below.

Symbol Width	Default Polynomials	Array Representation
3	$x^3 + x + 1$	11
4	$x^4 + x + 1$	19
5	$x^5 + x^2 + 1$	37
6	$x^6 + x + 1$	67
7	$x^7 + x^3 + 1$	137
8	$x^8 + x^4 + x^3 + x^2 + 1$	285
9	$x^9 + x^4 + 1$	529
10	$x^{10} + x^3 + 1$	1033
11	$x^{11} + x^2 + 1$	2053
12	$x^{12} + x^6 + x^4 + x + 1$	4179

- **Scaling Factor (h):** (represented in the previous formula as h) specifies the scaling factor for the code. Ordinarily, h is 1, but can be as large as  $2^S - 1$  where s is the symbol width. The value must be chosen so that  $\alpha^h$  is primitive. That is, h must be relatively prime to  $2^S - 1$ .
- **Generator Start:** specifies the first root r of the generator polynomial. The generator polynomial g(x), is given by:

$$g(x) = \prod_{j=0}^{n-k-1} (x - \alpha^{h(r+j)})$$

where  $\alpha$  is a primitive element of the symbol field, and the scaling factor is described below.

- **Symbols Per Block(n):** tells the number of symbols in the blocks the encoder produces. Acceptable numbers range from 3 to  $2^S - 1$ , where s denotes the symbol width.
- **Data Symbols(k):** tells the number of information symbols each block contains. Acceptable values range from  $\max(n - 256, 1)$  to  $n - 2$ .

## Detailed Implementation tab

### Implementation

#### Check Symbol Generator Optimization

This option is available when "Variable Number of Check Symbols" option is selected on the GUI.

- ◆ **Fixed Architecture:** The check symbol generator is implemented using a highly efficient fixed architecture.
- ◆ **Area:** The check symbol generator implementation is optimized for area and speed efficiency. The range of input, `ctrl_tdata_n_in`, is reduced.
- ◆ **Flexibility:** The check symbol generator implementation is optimized to maximize the range of input of `ctrl_tdata_n_in`.
- **Memory Style:** Select between **Distributed**, **Block** and **Automatic** memory choices. This option is available only for CCSDS codes.
- **Number Of Channels:** specifies the number of separate time division multiplexed channels to be processed by the encoder. The encoder supports up to 128 channels.

### Optional Pins

- **ACLKEN:** Adds a `aclken` pin to the block. This signal carries the clock enable and must be of type `Bool`.
- **Output TREADY:** When selected, the output channels will have a TREADY and hence support the full AXI handshake protocol with inherent back-pressure.
- **ARESETn:** Adds a `aresetn` pin to the block. This signal resets the block and must be of type `Bool`. `aresetn` must be asserted low for at least 2 clock periods and at least 1 sample period before the decoder can start decoding code symbols.
- **Info bit:** Adds the `output_tdata_info` pin. Marks the last information symbol of a block on `tdata_data_out`.
- **Marker Bits:** Adds the following pins to the block:
  - ◆ **input\_tuser\_user:** carries marker bits for tagging data on `input_tdata_data_in`.
  - ◆ **output\_tuser\_user:** `mark_in` tagging bits delayed by the latency of the LogiCORE.
- **Number of Marker Bits:** specifies the number of marker bits.

Other parameters used by this block are explained in the topic [Common Options in Block Parameter Dialog Boxes](#).

This is a licensed core, available for purchase on the Xilinx web site at:

[http://www.xilinx.com/xlnx/xebiz/designResources/ip\\_product\\_details.jsp?key=DO-DI-RSE](http://www.xilinx.com/xlnx/xebiz/designResources/ip_product_details.jsp?key=DO-DI-RSE).

## LogiCORE™ Documentation

[LogiCORE IP Reed-Solomon Encoder v8.0](#)

## Device Support

Zynq-7000, Artix-7, Virtex-7, Kintex-7, Virtex-6, Spartan-6



## Register

This block is listed in the following Xilinx Blockset libraries: *Basic Elements, Control Logic, Floating-Point, Memory, and Index.*



The Xilinx Register block models a D flip-flop-based register, having latency of one sample period.

### Block Interface

The block has one input port for the data and an optional input reset port. The initial output value is specified by you in the block parameters dialog box (below). Data presented at the input will appear at the output after one sample period. Upon reset, the register assumes the initial value specified in the parameters dialog box.

The Register block differs from the Xilinx Delay block by providing an optional reset port and a user specifiable initial value.

### Block Parameters

The block parameters dialog box can be invoked by double-clicking the icon in your Simulink model.

#### Basic tab

Parameters specific to the Basic tab are as follows:

- **Initial value:** specifies the initial value in the register.

Other parameters used by this block are explained in the topic [Common Options in Block Parameter Dialog Boxes](#).

### LogiCORE™ Documentation

[LogiCORE IP Floating-Point Operator v6.1](#)

### Device Support

Floating-Point support is restricted to the following devices:

Virtex-7, Kintex-7, Artix™-7, Zynq™-7000, Virtex-6, Spartan-6

## Reinterpret

This block is listed in the following Xilinx Blockset libraries: *Basic Elements, Floating-Point, Math, and Index.*



The Xilinx Reinterpret block forces its output to a new type without any regard for retaining the numerical value represented by the input.

The binary representation is passed through unchanged, so in hardware this block consumes no resources. The number of bits in the output will always be the same as the number of bits in the input.

The block allows for unsigned data to be reinterpreted as signed data, or, conversely, for signed data to be reinterpreted as unsigned. It also allows for the reinterpretation of the data's scaling, through the repositioning of the binary point within the data. The Xilinx Scale block provides an analogous capability.

An example of this block's use is as follows: if the input type is 6 bits wide and signed, with 2 fractional bits and the output type is forced to be unsigned with 0 fractional bits, then an input of -2.0 (1110.00 in binary, two's complement) would be translated into an output of 56 (111000 in binary).

This block can be particularly useful in applications that combine it with the Xilinx Slice block or the Xilinx Concat block. To illustrate the block's use, consider the following scenario:

Given two signals, one carrying signed data and the other carrying two unsigned bits (a `UFix_2_0`), we want to design a system that concatenates the two bits from the second signal onto the tail (least significant bits) of the signed signal.

We can do so using two Reinterpret blocks and one Concat block. The first Reinterpret block is used to force the signed input signal to be treated as an unsigned value with its binary point at zero. The result is then fed through the Concat block along with the other signal's `UFix_2_0`. The Concat operation is then followed by a second Reinterpret that forces the output of the Concat block back into a signed interpretation with the binary point appropriately repositioned.

Though three blocks are required in this construction, the hardware implementation is realized as simply a bus concatenation, which has no cost in hardware.

## Block Parameters

Parameters specific to the block are:

- **Force Arithmetic Type:** When checked, the Output Arithmetic Type parameter can be set and the output type is forced to the arithmetic type chosen according to the setting of the Output Arithmetic Type parameter. When unchecked, the arithmetic type of the output is unchanged from the arithmetic type of the input.
- **Output Arithmetic Type:** The arithmetic type (unsigned or signed, 2's complement, Floating-point) to which the output is to be forced.
- **Force Binary Point:** When checked, the Output Binary Point parameter can be set and the binary point position of the output is forced to the position supplied in the Output Binary Point parameter. When unchecked, the arithmetic type of the output is unchanged from the arithmetic type of the input.
- **Output Binary Point:** The position to which the output's binary point is to be forced. The supplied value must be an integer between zero and the number of bits in the input (inclusive).

## LogiCORE™ Documentation

[LogiCORE IP Floating-Point Operator v6.1](#)

### Device Support

Floating-Point support is restricted to the following devices:

Virtex-7, Kintex-7, Artix™-7, Zynq™-7000, Virtex-6, Spartan-6

## Relational

This block is listed in the following Xilinx Blockset libraries: Basic Elements, Control Logic, Floating-Point, Math, and Index.

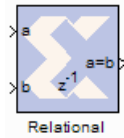

The Xilinx Relational block implements a comparator.

The supported comparisons are the following:

- equal-to ( $a = b$ )
- not-equal-to ( $a \neq b$ )
- less-than ( $a < b$ )
- greater-than ( $a > b$ )
- less-than-or-equal-to ( $a \leq b$ )
- greater-than-or-equal-to ( $a \geq b$ )
- The output of the block is a `bool`.

### Block Parameters

The block parameters dialog box can be invoked by double-clicking the icon in your Simulink model.

The only parameter specific to the Relational block is:

- **Comparison:** specifies the comparison operation computed by the block.

Other parameters used by this block are explained in the topic [Common Options in Block Parameter Dialog Boxes](#).

### LogiCORE™ Documentation

[LogiCORE IP Floating-Point Operator v6.1](#)

### Device Support

Floating-Point support is restricted to the following devices:

Virtex-7, Kintex-7, Artix™-7, Zynq™-7000, Virtex-6, Spartan-6

## Reset Generator

This block is listed in the following Xilinx Blockset libraries: *Basic Elements and Index*.

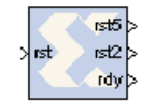

Reset Generator

The Reset Generator block captures the user's reset signal that is running at the system sample rate, and produces one or more downsampled reset signal(s) running at the rates specified on the block.

The downsampled reset signals are synchronized in the same way as they are during startup. The RDY output signal indicates when the downsampled resets are no longer asserted after the input reset is detected.

## Block Parameters

The block parameters dialog box shown below can be invoked by double-clicking the icon in your Simulink model.

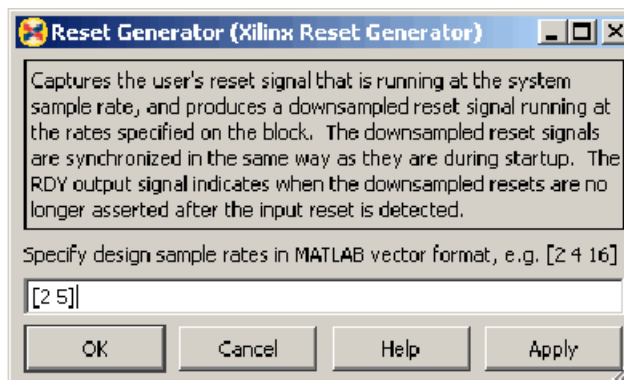

You specify the design sample rates in MATLAB vector format as shown above. Any number of outputs can be specified.

## Resource Estimator

This block is listed in the following Xilinx Blockset libraries: *Tools and Index*.



The Xilinx Resource Estimator block provides fast estimates of FPGA resources required to implement a System Generator subsystem or model.

These estimates are computed by invoking block-specific estimators for Xilinx blocks, and summing these values to obtain aggregated estimates of lookup tables (LUTs), flip-flops (FFs), block memories (BRAM), 18x18 multipliers, tristate buffers, and I/Os.

Every Xilinx block that requires FPGA resources has a mask parameter that stores a vector containing its resource requirements. The Resource Estimator block can invoke underlying functions to populate these vectors (e.g. after parameters or data types have been changed), or aggregate previously computed values that have been stored in the vectors. Each block has a checkbox control `Define FPGA area for resource estimation` that short-circuits invocation of the estimator function and uses the estimates stored in the vector instead.

An estimator block can be placed in any subsystem of a model. When another estimator block is situated in the sub-hierarchy below an estimator, the blocks interact as described below.

### Block Parameters

The block parameters dialog box can be invoked by double-clicking the icon in your Simulink model.

Parameters in the Resource Estimator dialog box are:

- **Slices:** Slices utilized by the block. (A slice normally consists of two flip-flops, two LUTs and associated mux, carry and control logic.)
- **FFs:** Flip-Flops utilized by the block.
- **BRAMs:** Block RAMs utilized by the block.
- **LUTs:** Look-up Tables utilized by the block.
- **IOBs:** Input/Output blocks consumed by the block.
- **Embedded Mults:** Embedded multipliers utilized by the block. (For example, the Virtex®-4 device contains embedded 18X18 multipliers.)
- **TBUFs:** Tristate Buffers utilized by the block.
- **Use Area Above:** When this box is checked, any resource estimation performed on this subsystem will return the numbers entered in the edit boxes of the dialog box (The data represented by these fields is equivalent to the FPGA Area field in the individual System Generator blocks). Any blocks at the level of the subsystem where this block resides, or below, will have no automatic resource estimation performed when this box is checked.
- **Estimate Options:** Allows selection of estimation method as one of the following: Estimate, Quick, Post Map and Read Mrp. These options are explained in greater detail in the next topic.
- **Estimate:** Launches resource estimation

### Perform Resource Estimation Buttons

The FPGA Area fields described above can either be manually entered or filled in by launching resource estimation with Estimate Options set to one of the following:

- **Estimate:** Invokes block estimation functions top-down for each block and subsystem recursively. Blocks that do not have an estimation function but can be implemented in

hardware (except shared memory blocks) are automatically estimated using post-map area. If any block has the Define FPGA area for resource estimation option selected, its estimation function is short-circuited and its current estimate is used. If Use area above option is selected for a Resource Estimator block, this block's estimate is used for the entire subsystem containing it, and no other block estimation functions are invoked for that portion of the model hierarchy.

- **Quick:** Causes the **Estimate** button to sum all of the FPGA Area fields on the blocks and subsystems at or below the current subsystem. No underlying estimation functions are invoked.
- **Post-Map Area:** Causes the **Estimate** button to automatically invoke Xilinx map tool on the entire subsystem and read back the results from the created Map Report File (MRP). In order to use this option a System Generator token along with the resource estimator block must be instantiated in the subsystem being estimated.
- **Read MRP:** Causes the **Estimate** button to open a file browser. The results from a selected MRP file are read into the Resource Estimator. This method of obtaining resource information is available for subsystems that have been previously synthesized, translated and mapped. This can be useful for complex Xilinx blocks that have no estimation function and will no longer change in a design.

The numbers from the map report file and those inserted into the Resource Estimator dialog box area fields might be slightly different (this applies to Post Map Area option also). Any IOB FF resources found in the MRP file are added into the estimators FFs field. Along the same lines, half of the MRP's IOB FF resources are added into the estimators Slices field and the estimators IOBs field will always be set to 0 after performing a Post-Map Area MRP or Read MRP. Since the usefulness of this feature generally occurs in estimating subsystems, IOB resources must be included in the CLB utilization numbers to prevent incorrectly reporting IOB resources not used in the final design.

## Blocks Supported by Resource Estimation

### Blocks that have Fast Resource Estimation Functions:

Accumulator, Addressable Shift Register, AddSub, CMult (sequential version not supported), Convert, Counter, Delay, Down Sample, Dual Port RAM, FIFO, FFT, FFTx, Gateway In, Gateway Out, Inverter, LFSR, Logical, Mult (sequential version not supported), Mux (tristate version not supported), Negate, Parallel to Serial, PicoBlaze Processor, Register, Relational, ROM, Serial To Parallel, Shift, Sine Cosine, Single Port RAM, Threshold, Up Sample.

### Blocks that Use Post Map Area Estimates:

System generator blocks that do not have fast resource estimation functions and use hardware are estimated using post-map area. In order to avoid using this method enter in a constant or a user-created estimation function into the FPGA Area field of the block and click on the **Define FPGA area for resource estimation** checkbox.

### Blocks that Do Not Use Any Hardware:

System Generator, Clear Quantization Error, Clock Enable Probe, Clock Probe, Concat, Constant, Discard Subsystem, FDATool, Indeterminate Probe, ModelSim, Pause Simulation, PicoBlaze Instruction Display, Quantization Error, Reinterpret, Sample Time, Scale, Simulation Multiplexer, Single-Step Simulation, Slice, BitBasher.

## Blocks with Special Handling:

Discard Subsystem (Resource Estimator will ignore any resources in a subsystem containing this block). Shared memory blocks are not estimated. In designs containing Shared Memory blocks, use the Multiple System Generator block to generate the HDL netlist files. Use ISE® software to create the Map Report File for the design and use the Read MRP option to obtain the results contained in the MRP file produced.

## Viewing ISE Reports

When you select the **Post Map** Estimate option and click the **Estimate**, the **Running Resource Estimator** dialog box appears as shown below. You can then click on the **Show Reports** button and the associated ISE Reports are available for your viewing:

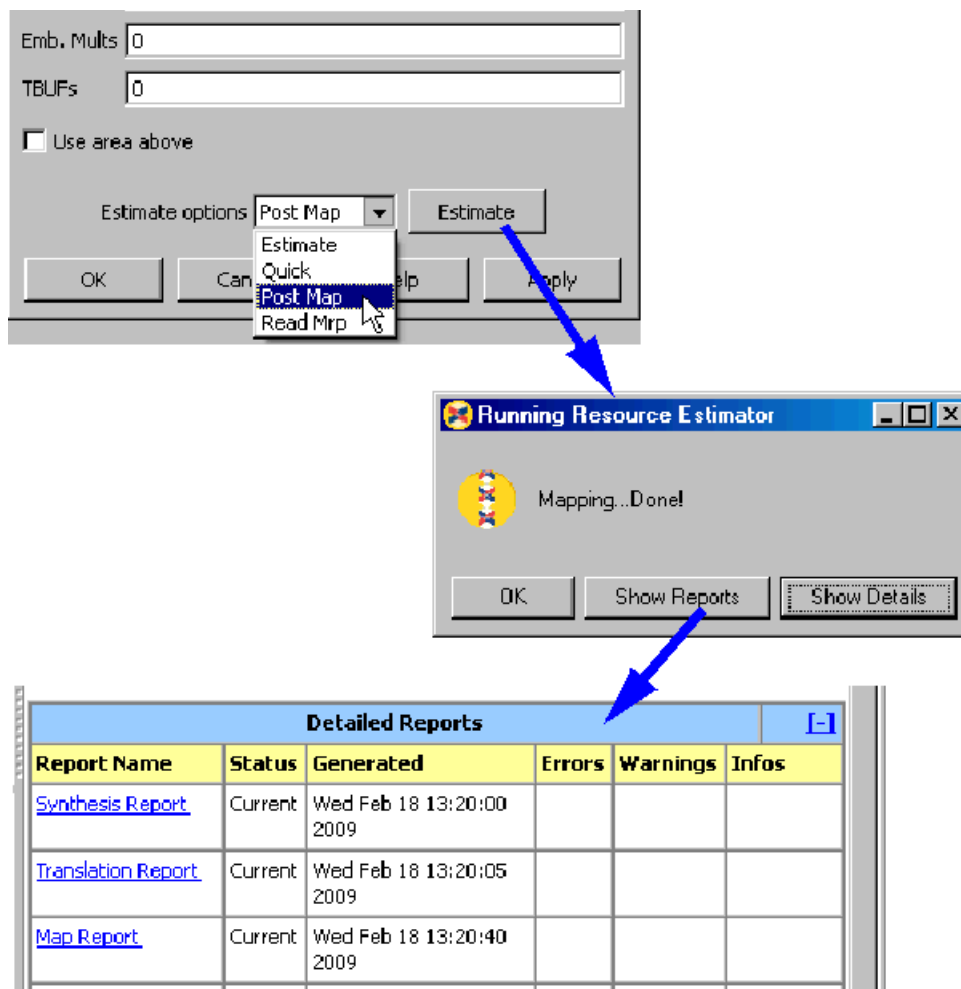

## Known Issues for Resource Estimation

Resource estimation in System Generator has the following known issues:

- Estimations are based upon the data types for the inputs and outputs of each block that Simulink calculates during the compilation phase. If significant trimming takes place in a



design that is not seen at the block level, the resource estimation tool will overestimate those trimmed resources.

- Any logic that the synthesis tools can combine across blocks is overestimated. For example, when using blocks that have no latency, there is a good chance combinational logic is optimized across block boundaries.
- Multirate designs contain clock enable generation logic that is underestimated. System Generator handles multirate designs by using one clock and generating a different clock enable for each rate. In order to accurately predict the amount of logic in the clock enable drivers, the estimator would need to look at the system as a whole instead of at the block level. Note, this underestimation will also include resources associated with additional clock enable connections that are made to each of the blocks that were not visible to the block estimation functions.
- Shared Memory Blocks are not estimated. In designs containing Shared Memory blocks, the estimates reported do not include the resources used by the Shared Memory blocks.

## ROM

This block is listed in the following Xilinx Blockset libraries: *Control Logic, Memory, Floating-Point and Index.*

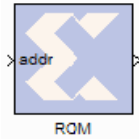

The Xilinx ROM block is a single port read-only memory (ROM). Values are stored by word and all words have the same arithmetic type, width, and binary point position. Each word is associated with exactly one address. An address can be any unsigned fixed-point integer from 0 to  $d-1$ , where  $d$  denotes the ROM depth (number of words). The memory contents are specified through a block parameter. The block has one input port for the memory address and one output port for data out. The address port must be an unsigned fixed-point integer. The block has two possible Xilinx LogiCORE™ implementations, using either distributed or block memory.

When implementing single port ROM blocks on Virtex®-4, Virtex-5, Virtex-6, Spartan-6, and Spartan®-3A DSP devices, maximum timing performance is possible if the following conditions are satisfied:

- The option **Provide reset port for output register** is un-checked
- The option **Depth** is less than 16,384
- The option **Latency** is set to 2 or higher

### Block Parameters

The block parameters dialog box can be invoked by double-clicking the icon in your Simulink model.

#### Basic tab

Parameters specific to the Basic tab are as follows:

- **Depth:** specifies the number of words stored; must be a positive integer.
- **Initial value vector:** specifies the initial value. When the vector is longer than the ROM depth, the vector's trailing elements are discarded. When the ROM is deeper than the vector length, the ROM's trailing words are set to zero. The initial value vector is saturated or rounded according to the data precision specified for the ROM.
- **Memory Type:** specifies block implementation to be distributed RAM or Block RAM.
- **Provide reset port for output register:** when selected, allows access to the reset port available on the output register of the Block ROM. The reset port is available only when the latency of the Block ROM is set to 1.
- **Initial value for output register:** specifies the initial value for output register. The initial value is saturated and rounded according to the data precision specified for the ROM. The option to set initial value is available only for Spartan®-3, Virtex-4, Virtex-5, Virtex-6, Spartan-6 and Spartan-3A DSP devices.

#### Output

- Specifies the data type of the output. Can be **Boolean**, **Fixed-point**, or **Floating-point**.  
Arithmetic Type: If the Output Type is specified as Fixed-point, you can select **Signed (2's comp)** or **Unsigned** as the Arithmetic Type.  
Fixed-point Precision

- ◆ **Number of bits:** specifies the bit location of the binary point of the output number, where bit zero is the least significant bit.
- ◆ **Binary point:** position of the binary point. in the fixed-point output

#### Floating-point Precision

- **Single:** Specifies single precision (32 bits)
- **Double:** Specifies double precision (64 bits)
- **Custom:** Activates the field below so you can specify the Exponent width and the Fraction width.

**Exponent width:** Specify the exponent width

- ◆ **Fraction width:** Specify the fraction width

Other parameters used by this block are explained in the topic [Common Options in Block Parameter Dialog Boxes](#).

## LogiCORE™ Documentation

The block always uses a Xilinx LogiCORE™: Single Port Block Memory or Distributed Memory.

For the block memory, the address width must be equal to  $\text{ceil}(\log_2(d))$  where  $d$  denotes the memory depth. The maximum width of data words in the block memory depends on the depth specified; the maximum depth is depends on the device family targeted. The tables below provide the maximum data word width for a given block memory depth.

[LogiCORE IP Block Memory Generator v6.3](#)

[LogiCORE IP Distributed Memory Generator v6.3](#)

[LogiCORE IP Floating-Point Operator v6.1](#)

## Device Support

Floating-Point support is restricted to the following devices:

Virtex-7, Kintex-7, Artix-7, Zynq-7000, Virtex-6, Spartan-6

## Maximum Width for Various Depth Ranges (Spartan®-3)

Depth	Width
2 to 2048	256
2049 to 4096	192
4097 to 8192	96
8193 to 16K	48
16K+1 to 32K	24
32K+1 to 64K	12
64K+1 to 128K	6
128K+1 to 256K	3

## Width for Various Depth Ranges (Virtex-4/Virtex-5/Spartan-3A DSP)

Depth	Width
2 to 8192	256
8193 to 16K	192
16K+1 to 32K	96
32K+1 to 64K	48
64K+1 to 128K	24
128K+1 to 256K	12
256K+1 to 512K	6
512K+1 to 1024K	3

When the distributed memory parameter is selected, LogiCORE Distributed Memory is used. The depth must be between 16 and 65536, inclusive for Spartan-3, and Virtex-4, Virtex-5, and Spartan-3A DSP; depth must be between 16 to 4096, inclusive for the other FPGA families. The word width must be between 1 and 1024, inclusive.

## Register

This block is listed in the following Xilinx Blockset libraries: *Basic Elements, Control Logic, Memory, Floating-Point and Index.*



The Xilinx Register block models a D flip-flop-based register, having latency of one sample period.

### Block Interface

The block has one input port for the data and an optional input reset port. The initial output value is specified by you in the block parameters dialog box (below). Data presented at the input will appear at the output after one sample period. Upon reset, the register assumes the initial value specified in the parameters dialog box.

The Register block differs from the Xilinx Delay block by providing an optional reset port and a user specifiable initial value.

### Block Parameters

The block parameters dialog box can be invoked by double-clicking the icon in your Simulink model.

#### Basic tab

Parameters specific to the Basic tab are as follows:

- **Initial value:** specifies the initial value in the register.

#### Optional Ports

Other parameters used by this block are explained in the topic [Common Options in Block Parameter Dialog Boxes](#).

### Xilinx LogiCORE

The Register block is implemented as a synthesizable VHDL module. It does not use a Xilinx LogiCORE™.

## Sample Time

*This block is listed in the following Xilinx Blockset libraries: Tools and Index.*



The Sample Time block reports the normalized sample period of its input. A signal's normalized sample period is not equivalent to its Simulink absolute sample period. In hardware, this block is implemented as a constant.

## Scale

*This block is listed in the following Xilinx Blockset libraries: Data Types, Math, and Index.*

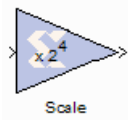

The Xilinx Scale block scales its input by a power of two. The power can be either positive or negative. The block has one input and one output. The scale operation has the effect of moving the binary point without changing the bits in the container

### Block Parameters

The block parameters dialog box can be invoked by double-clicking the icon in your Simulink model.

The only parameter that is specific to the Scale block is Scale factor  $s$ . It can be a positive or negative integer. The output of the block is  $i \cdot 2^k$ , where  $i$  is the input value and  $k$  is the scale factor. The effect of scaling is to move the binary point, which in hardware has no cost (a shift, on the other hand, might add logic).

Other parameters used by this block are explained in the topic [Common Options in Block Parameter Dialog Boxes](#).

### Xilinx LogiCore

The Scale block does not use a Xilinx LogiCORE™.

## Serial to Parallel

This block is listed in the following Xilinx Blockset libraries: *Basic Elements, Data Types, and Index.*



The Serial to Parallel block takes a series of inputs of any size and creates a single output of a specified multiple of that size. The input series can be ordered either with the most significant word first or the least significant word first.

The following waveform illustrates the block's behavior:

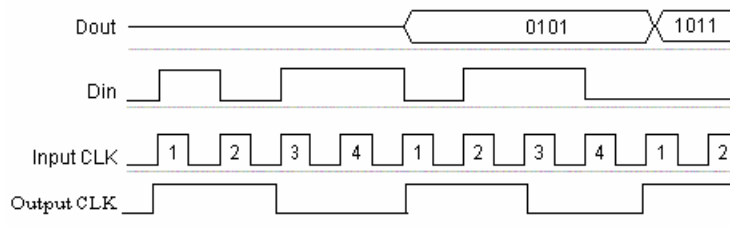

This example illustrates the case where the input width is 1, output width is 4, word size is 1 bit, and the block is configured for most significant word first.

## Block Interface

The Serial to Parallel block has one input and one output port. The input port can be any size. The output port size is indicated on the block parameters dialog box.

## Block Parameters

The block parameters dialog box can be invoked by double-clicking the icon in your Simulink model.

### Basic tab

Parameters specific to the Basic tab are as follows:

- **Input order:** Least or most significant word first.
- **Arithmetic type:** Signed or unsigned output.
- **Number of bits:** Output width which must be a multiple of the number of input bits.
- **Binary point:** Output binary point location

Other parameters used by this block are explained in the topic [Common Options in Block Parameter Dialog Boxes](#).

An error is reported when the number of output bits cannot be divided evenly by the number of input bits. The minimum latency for this block is zero.



## Shared Memory

This block is listed in the following Xilinx Blockset libraries: *Shared Memory*, *Floating-Point* and *Index*.

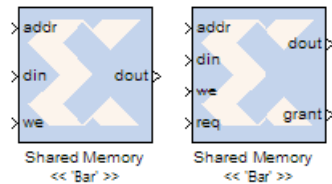

The Xilinx Shared Memory block implements a random access memory (RAM) that can be shared among multiple designs or sections of a design.

A Shared Memory Block is uniquely identified by its name. In the blocks above, the shared memory has been named "Bar". Instances of Shared Memory "Bar", whether within the same model or in different models or even different instances of MATLAB, will share the same memory space. System Generator's hardware co-simulation interfaces allow shared memory blocks to be compiled and co-simulated in FPGA hardware. These interfaces make it possible for hardware-based shared memory resources to map transparently to common address spaces on a host PC. When used in System Generator co-simulation hardware, shared memories facilitate high-speed data transfers between the host PC and FPGA, and bolster the tool's real-time hardware co-simulation capabilities. Starting with the 9.2 release, during netlisting, each pair of **Shared Memory** blocks with the same name are stitched together as a BRAM-based "Dual Port RAM block" in the netlist. For **Shared Memory** blocks that do not form a pair, their input and output ports are pushed to the top level of System Generator design. A pair of matching blocks can exist anywhere in the design hierarchy, however, if more than two **Shared Memory** blocks with the same name exist in the design, then an error is issued.

For backward compatibility, you can set the MATLAB global variable `xlSgSharedMemoryStitch` to "off" to bring System Generator back to the netlisting behavior before the 9.2 release. For example, from the MATLAB command line, enter the following:

```
global xlSgSharedMemoryStitch;
xlSgSharedMemoryStitch = 'off';
```

### Block Interface

By default, the shared memory block has 3 inputs (`addr`, `din` and `we`) and 1 output (`dout`). Access to the shared memory can be protected by setting the Access protection parameter to Lockable. Setting access protection to Lockable causes two additional ports to appear; an input port `req` and an output port `grant`.

The `addr` port should be driven by a signal of type `UFIX_N_0`, where `N` equals `ceil(log2(depth))`. The memory word size is determined, at compile-time, by the bit width of the signal driving `din`. Driving the write enable port (`we`) with 1 indicates that the value on the `din` port should be written to the memory address pointed to by port `addr`.

When access protection is set to Lockable, the `req` and `grant` ports are used to control access to the memory. Before a read or write can occur, a request must first be made by setting `req` to 1. When `grant` becomes 1, the request for access has been allowed and read or write operations can proceed. The figure below shows the relationship between the `req`, `grant` and `we` ports. The figure also

shows that the block output is suppressed until access to the memory is granted.

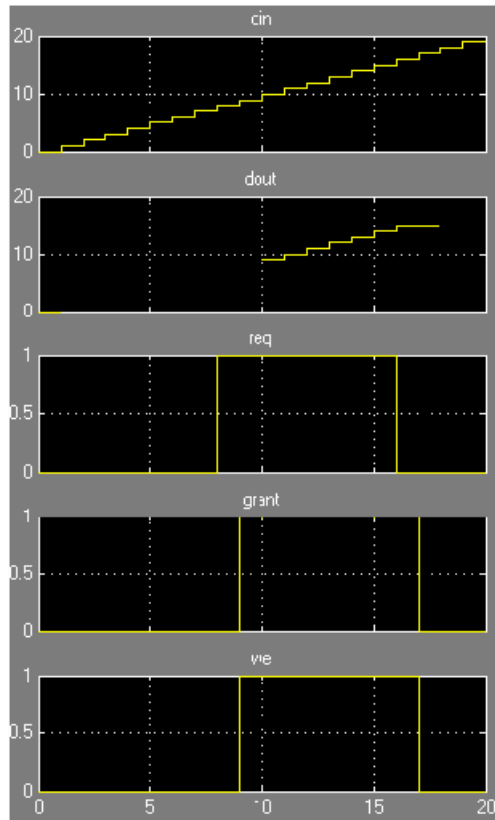

The output during a write operation depends on the write mode. When the `we` is 0, the output port has the value at the location specified by the address line. During a write operation (`we` asserted), the data presented on the input data port is stored in memory at the location selected by the port's address input. During a write cycle, you can configure the behavior of the data out port to one of the following choices:

- Read After Write
- Read Before Write
- No Read On Write

The write modes can be described with the help of the figure below. In the figure below, the memory has been set to an initial value of 5 and the address bit is specified as 2. When using No Read On Write mode, the output is unaffected by the address line and the output is the same as the last output when `we` was 0. When `we` is 1, `dout` holds its previous value until `we` is 1. In the figure below, you see `dout` reflecting the value of `addr` position 2, one cycle after `we` is set to 1.

For the other two modes, the output is obtained from the location specified by the address line, and hence is the value of the location being written to. This means that the output can be the old value which corresponds to Read After Write.

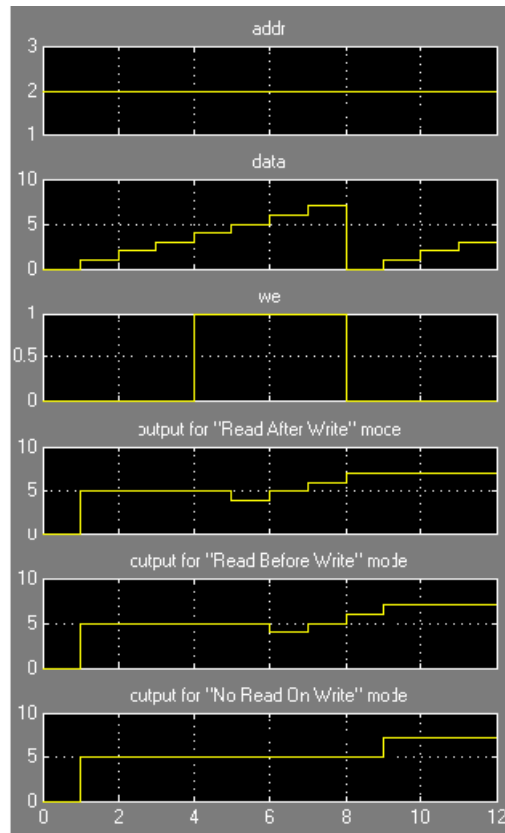

## Block Parameters

The block parameters dialog box can be invoked by double-clicking the icon in your Simulink model.

### Basic tab

Parameters specific to the Basic tab are as follows:

- Shared memory name:** name of the shared memory. All memories with the same name share the same physical memory.
 

*Note:* The EDK Processor block does not support Shared Memory blocks with spaces in their names.
- Depth:** specifies the number of words in the memory. The word size is inferred from the bit width of the data port din.
- Ownership and initialization:** indicates whether the memory is Locally owned and initialized or Owned and initialized elsewhere. If the memory is locally owned and initialized, the Initial value vector parameter is made available. A block that is Locally owned and initialized is responsible for creating an instance of the memory. A block that is Owned and initialized elsewhere attaches itself to a memory instance that has already been created. As a result, if two shared memory blocks are used in two different models during simulation, the model containing the Locally owned and initialized block has to be started first.

- **Initial value vector:** specifies initial memory contents. The size and precision of the elements of the initial value vector are inferred from the type of the data samples that drive din. When the vector is longer than the RAM, the vector's trailing elements are discarded. When the RAM is longer than the vector, the RAM's trailing words are set to zero. The initial value vector is saturated and rounded according to the precision specified on the data port din.
- **Access protection:** either Lockable or Unprotected. An unprotected memory has no restrictions concerning when a read or write can occur. In a locked shared memory, the block can only be written to when granted access to the memory. When the grant port outputs a 1, access is granted to the memory and the write request can proceed.
- **Access mode:** specifies the way in which the memory is used by the design. When Read and write mode is used, the block is configured with din and dout ports. When Read only mode is used, the block is configured with a dout port for memory read access. When Write only mode is used, the block is configured with a din port for memory write access.
- **Write mode:** specifies the memory behavior to be Read after write, Read before write, or No read on write. There are device specific restrictions on the applicability of these modes.
- **Memory access timeout (sec):** when the memory is running in hardware, this specifies the maximum time to wait for the memory to respond to a request.
- **Latency:** can be set to 1 or 2.

## Output tab

### Output Precision

- Specifies the data type of the output. Can be **Fixed-point** or **Floating-point**.  
Arithmetic Type: If the Output Type is specified as Fixed-point, you can select **Signed (2's comp)** or **Unsigned** as the Arithmetic Type.

#### Fixed-point Precision

- ◆ **Number of bits:** specifies the bit location of the binary point of the output number, where bit zero is the least significant bit.
- ◆ **Binary point:** position of the binary point. in the fixed-point output

#### Floating-point Precision

- ◆ **Single:** specifies single precision (32 bits)

Other parameters used by this block are explained in the topic [Common Options in Block Parameter Dialog Boxes](#).

## LogiCORE™ Documentation

[LogiCORE IP Block Memory Generator v6.3](#)

## Device Support

Virtex-7, Virtex-6, Virtex-5, Virtex-4, Virtex-II, Virtex-II Pro, Zynq-7000, Artix-7, Kintex-7, Spartan-6, Spartan-3E/XA, Spartan-3/XA, Spartan-3A/3AN/3A DSP

## Shared Memory Read

This block is listed in the following Xilinx Blockset libraries: *Shared Memory* and *Index*.



The Xilinx Shared Memory Read block provides a high-speed interface for reading data from a Xilinx shared memory object. Both FIFO and lockable shared memory objects are supported by the block.

The requested data is read out of the shared memory and into a Simulink scalar, vector, or matrix signal which is written to the block's output port. The bracketed text beneath the block indicates shared memory with which this block interfaces. The depth and width displays on the block indicate the size of the shared memory. These values are updated at runtime when the block makes the connection to the shared memory object.

The Shared Memory Read block performs several transactions with its associated shared memory object when it is woken up during a simulation. The frequency at which the block is woken up is determined by its **Sample Time** parameter. The type of transactions performed depends on whether the block is associated with a FIFO or lockable shared memory object.

### FIFO Transactions

The transactions with a shared FIFO object are listed below in their order of occurrence during a simulation cycle:

- **Wait for Data:** The Shared Memory Read block waits for the shared FIFO object to become empty. If the shared FIFO object is not empty after 15 seconds, the Shared Memory Read block will time out and the simulation will terminate.
- **Read Data:** Once the block ensures a sufficient number of words are available, the Shared Memory Read block will read data from the shared FIFO object.

### Lockable Memory Transactions

The transactions with a lockable shared memory are listed below in their order of occurrence during a simulation cycle:

- **Acquire Lock:** Before the Shared Memory Read block can read the shared memory contents, it must acquire lock over the shared memory object. If the block fails to gain lock after 15 seconds, it will time out and the simulation will terminate.
- **Read Data:** Once lock is acquired, the Shared Memory Read block will read data from the shared memory object.
- **Release Lock:** The Shared Memory Read block releases the lock after reading data from the shared memory object.

The Shared Memory Read block is useful for simulation only and is ignored during netlisting. In particular, the Shared Memory Read block can be applied to hardware co-simulation designs with high throughput requirements. For more information on how this done, see the topic [Real-Time Signal Processing using Hardware Co-Simulation](#)

## Block Parameters

The block parameters dialog box can be invoked by double-clicking the icon in your Simulink model.

### Basic tab

Parameters specific to the Basic tab are as follows:

- **Shared memory name:** This parameter tells the unique string identifier for the Xilinx shared memory object from which data should be read. The shared memory must be a shared FIFO or lockable memory that is created and initialized elsewhere (for example, the Shared Memory Read block does not create the specified shared memory object).
- **Type:** Tells whether the block should read from a Xilinx shared FIFO or Lockable memory object.
- **Sample time:** Specifies how often this block should read from the shared memory.

### Output Type tab

Parameters specific to the Output Type tab are as follows:

- **Data type:** Specifies how shared memory data words should be interpreted by the Shared Memory Read block. The Simulink scalar, vector, or matrix signal that is generated are of the chosen data type. The supported data types are int8, uint8, int16, uint16, int32, and uint32. The width of the chosen data type must match the width of the data stored in the shared memory object. For example, if the width of the shared memory data is 16 bits, then you can choose int16 or uint16.
- **Output dimensions:** Specifies how the shared memory data image should be interpreted, by giving the size of each available dimension. For a vectored output, only a single dimension (N) must be specified. For a matrix output, specify the dimensions in a two-element array [M, N], where M gives the number of rows, and N gives the number of columns. The total number of elements in the output (N, or M\*N) must not be greater than the depth of the shared memory.
- **Use frame-based output:** Specifies whether the output signal from the Shared Memory Read block should be represented as a frame-based signal or a sample-based signal. Frame-based signals represent consecutive sample-based signals that have been buffered together. For example, a frame-based output would be suitable for driving a Simulink Unbuffer block. Note that enabling frame-based output requires a two-dimensional output specified in the Output Dimensions parameter.

## See Also

[Shared Memory Write](#)

[Real-Time Signal Processing using Hardware Co-Simulation](#)

## Shared Memory Write

This block is listed in the following Xilinx Blockset libraries: *Shared Memory* and *Index*.

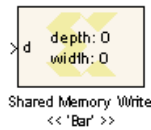

The Xilinx Shared Memory Write block provides a high-speed interface for writing data into a Xilinx shared memory object. Both FIFO and lockable shared memory objects are supported by the block.

The Shared Memory Write block input port should be driven by the Simulink scalar, vector, or matrix signal containing the data you would like written into the shared memory object. The bracketed text beneath the block indicates the shared memory with which this block interfaces. The depth and width displays on the block indicate the size of the shared memory - these values are updated at runtime when the block makes the connection to shared memory. The width of the input data must match the width of the shared memory, and the total number of elements in the input must not be bigger than the depth of the shared memory object.

The Shared Memory Write block performs several transactions with its associated shared memory object when it is woken up during a simulation. The frequency at which the block is woken up is determined by its sample period, which is inherited from the signal driving its input port. The type of transactions performed depends on whether the block is associated with a FIFO or lockable shared memory object.

### FIFO Transactions

The transactions with a shared FIFO object are listed below in their order of occurrence during a simulation cycle:

- **Wait for Available Storage:** The Shared Memory Write block waits for the shared FIFO object to become empty. If the shared FIFO object is not empty after 15 seconds, the Shared Memory Write block will time out and the simulation will terminate.
- **Write Data:** Once the block ensures a sufficient amount of available, the Shared Memory Write block will write data into the shared FIFO object.

### Lockable Memory Transactions

- **Acquire Lock:** Before the Shared Memory Write block can write to the shared memory contents, it must acquire lock over the shared memory object. If the block fails to gain lock after 15 seconds, it will time out and the simulation will terminate.
- **Write Data:** Once lock is acquired, the Shared Memory Write block will write data to the shared memory object.
- **Release Lock:** The Shared Memory Write block releases the lock after writing data to the shared memory object.

The Shared Memory Write block is useful for simulation only and is ignored during netlisting. In particular, the Shared Memory Write block can be applied to hardware co-simulation designs with high throughput requirements. For more information on how this done, see the topic [Real-Time Signal Processing using Hardware Co-Simulation](#).

## Block Parameters

The block parameters dialog box can be invoked by double-clicking the icon in your Simulink model.

Parameters specific to the Shared Memory Write block are:

**Shared Memory Name:** This parameter gives the unique string identifier for the shared memory to which the block should write the incoming data. The memory must be a lockable memory that is created and initialized elsewhere (for example, the Shared Memory Write block does not create the specified shared memory object).

**Type:** Tells whether the block should write to a Xilinx shared FIFO or Lockable memory object.

## See Also

[Shared Memory Read](#)

[Real-Time Signal Processing using Hardware Co-Simulation](#)



## Shift

This block is listed in the following Xilinx Blockset libraries: *Control Logic, Data Types, Math and Index.*

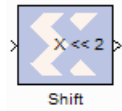

The Xilinx Shift block performs a left or right shift on the input signal. The result will have the same fixed-point container as that of the input.

### Block Parameters

Parameters specific to the Shift block are:

- **Shift direction:** specifies a direction, Left or Right. The Right shift moves the input toward the least significant bit within its container, with appropriate sign extension. Bits shifted out of the container are discarded. The Left shift moves the input toward the most significant bit within its container with zero padding of the least significant bits. Bits shifted out of the container are discarded.
- **Number of bits:** specifies how many bits are shifted. If the number is negative, direction selected with Shift direction is reversed.

Other parameters used by this block are explained in the topic [Common Options in Block Parameter Dialog Boxes](#).

### Xilinx LogiCORE

The Shift block does not use a Xilinx LogiCORE™.

## Simulation Multiplexer

*This block appears only in the Index library of the Xilinx Blockset.*

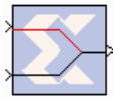

The Simulation Multiplexer has been deprecated in System Generator.

It is expected that the block is eliminated in a future version of the Xilinx Blockset. The functionality supplied by this block is now available through System Generator's support for Simulink's configurable subsystem capabilities. The use of configurable subsystems offers several advantages over the use of Simulation Multiplexer blocks.

The Simulation Multiplexer is a System Generator block that allows two portions of a design to work in parallel, with simulation results provided by the first portion and hardware provided by the second.

This is useful, for example, when a subsystem is defined in the usual way with Simulink blocks, but black box HDL is used to implement the subsystem in hardware. An example is shown below.

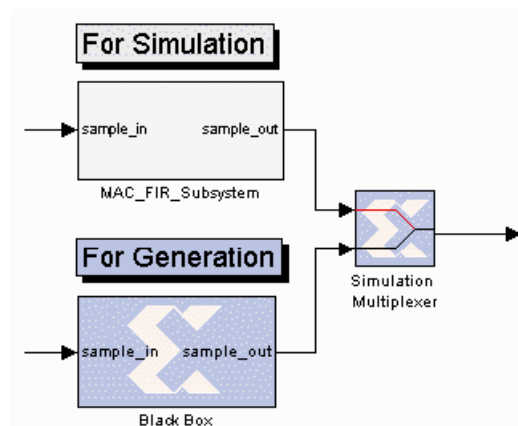

### Using Subsystem for Simulation and Black Box for Hardware

The Simulation Multiplexer has two inputs ports. In the block parameters dialog box, one port can be identified as For Simulation and a second as For Generation. The portion of the design that drives the For Simulation port is used as the simulation model, and the portion that drives For Generation is used to produce hardware. The same port can be used for both. In this case the portion of the design that drives the combined For Simulation/For Generation port is used both for simulation and to produce hardware, while the other portion is ignored. It should be noted that simulation results from a design that contains a Simulation Multiplexer need not be bit and cycle accurate.

The Simulation Multiplexer is useful whenever there is a difference between what should be used for simulation and what should be used in hardware. For example, a hardware co-simulation token with an accompanying FPGA bitstream can be simulated but cannot be translated into hardware. If the HDL used to produce the bitstream is available, a black box can incorporate the HDL. Driving a Simulation Multiplexer's For Simulation port with the token and its For Generation port with the black box makes it possible both to simulate the design and to produce hardware. Another use for the multiplexer is to switch between black boxes that incorporate different types of HDL. One might provide behavioral HDL to be used in simulation, and the other might provide RTL to be used for implementation.

## Block Parameters

The block parameters dialog box can be invoked by double-clicking the icon in your Simulink model.

Parameters specific to the block are:

**For Simulation, Pass Through Data from Input Port:** Determines which input port (either 1 or 2) is used for simulation.

**For Generation, Pass Through Data from Input Port:** Determines which input port (either 1 or 2) is used for generation.

## Single Port RAM

This block is listed in the following Xilinx Blockset libraries: Control Logic, Floating-Point, Memory, and Index.



The Xilinx Single Port RAM block implements a random access memory (RAM) with one data input and one data output port.

### Block Interface

The block has one output port and three input ports for address, input data, and write enable (WE). Values in a Single Port RAM are stored by word, and all words have the same arithmetic type, width, and binary point position.

A single-port RAM can be implemented using either block memory or distributed memory resources in the FPGA. Each data word is associated with exactly one address that must be an unsigned integer in the range 0 to  $d-1$ , where  $d$  denotes the RAM depth (number of words in the RAM). An attempt to read past the end of the memory is caught as an error in the simulation, though if a block memory implementation is chosen, it can be possible to read beyond the specified address range in hardware (with unpredictable results). The initial RAM contents can be specified through the block parameters.

The write enable signal must be Bool, and when its value is 1, the data input is written to the memory location indicated by the address input. The output during a write operation depends on the choice of memory implementation.

The behavior of the output port depends on the write mode selected (see below). When the WE is 0, the output port has the value at the location specified by the address line.

### Block Parameters

The block parameters dialog box can be invoked by double-clicking the icon in your Simulink model.

Parameters specific to this block are:

- **Depth:** the number of words in the memory; must be a positive integer.
- **Initial value vector:** the initial contents of the memory. When the vector length exceeds the memory depth, values with index higher than depth are ignored. When the depth exceeds the vector length, memory locations with addresses higher than the vector length are initialized to zero. Initialization values are saturated and rounded (if necessary) according to the precision specified on the data port.
- **Write Mode:** specifies memory behavior when WE is asserted. Supported modes are: Read before write, Read after write, and No read On write. Read before write indicates the output value reflects the state of the memory before the write operation. Read after write indicates the output value reflects the state of the memory after the write operation. No read on write indicates that the output value remains unchanged irrespective of change of address or state of the memory. There are device specific restrictions on the applicability of these modes. Also refer to the write modes and hardware notes topic below for more information.
- **Memory Type:** option to select between block and distributed RAM.

- **Provide reset port for output register:** exposes a reset port controlling the output register of the Block RAM. Note: this port does not reset the memory contents to the initialization value. The reset port is available only when the latency of the Block RAM is set to 1.
- **Initial value for output register:** the initial value for output register. The initial value is saturated and rounded as necessary according to the precision specified on the data port of the Block RAM.

Other parameters used by this block are explained in the Common Parameters topic at the beginning of this chapter.

## Write Modes

During a write operation (WE asserted), the data presented to the data input is stored in memory at the location selected by the address input. You can configure the behavior of the data out port A upon a write operation to one of the following modes:

- Read after write
- Read before write
- No read On write

These modes can be described with the help of the figure shown below. In the figure the memory has been set to an initial value of 5 and the address bit is specified as 4. When using No read on write mode, the output is unaffected by the address line and the output is the same as the last output when the WE was 0. For the other two modes, the output is obtained from the location specified by the address line, and hence is the value of the location being written to. This means that the output can

be either the old value (**Read before write mode**), or the new value (**Read after write mode**).

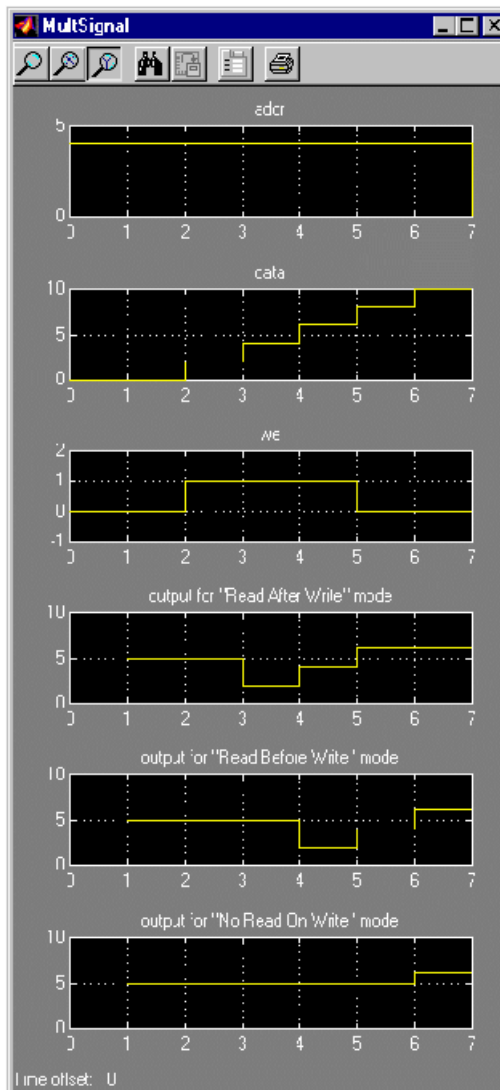

## Hardware Notes

The distributed memory LogiCORE™ supports only the Read before write mode. The Xilinx Single Port RAM block also allows distributed memory with write mode option set to Read after write when specified latency is greater than 0. The Read after write mode for the distributed memory is achieved by using extra hardware resources (a MUX at the distributed memory output to latch data during a write operation).

When implementing single port RAM blocks on Virtex®-4, Virtex-5, Virtex-6, Spartan®-6 and Spartan-3A DSP devices, maximum timing performance is possible if the following conditions are satisfied:

- The option **Provide reset port for output register** is un-checked
- The option **Depth** is less than 16,384
- The option **Latency** is set to 2 or higher

## Xilinx LogiCORE

The block always uses a Xilinx LogiCORE™: Single Port Block Memory or Distributed Memory.

For the block memory, the address width must be equal to  $\text{ceil}(\log_2(d))$  where  $d$  denotes the memory depth. The maximum width of data words in the block memory depends on the depth specified; the maximum depth depends on the device family targeted. The tables below provide the maximum data word width for a given block memory depth.

### Maximum Width for Various Depth Ranges (Virtex®/Virtex-E/Spartan®-3)

Depth	Width
2 to 2048	256
2049 to 4096	192
4097 to 8192	96
8193 to 16K	48
16K+1 to 32K	24
32K+1 to 64K	12
64K+1 to 128K	6
128K+1 to 256K	3

### Width for Various Depth Ranges (Virtex-4/Virtex-5/Spartan-3A DSP)

Depth	Width
2 to 8192	256
8193 to 16K	192
16K+1 to 32K	96
32K+1 to 64K	48
64K+1 to 128K	24
128K+1 to 256K	12
256K+1 to 512K	6
512K+1 to 1024K	3

When the distributed memory parameter is selected, LogiCORE™ Distributed Memory is used. The depth must be between 16 and 65536, inclusive for Spartan®-3, Virtex-™4, Virtex-5, Virtex-6, Spartan-6 and Spartan-3A DSP; depth must be between 16 to 4096, inclusive for the other FPGA families. The word width must be between 1 and 1024, inclusive.

## LogiCORE™ Documentation

[LogiCORE IP Block Memory Generator v6.3](#)

[LogiCORE IP Distributed Memory Generator v6.3](#)

[LogiCORE IP Floating-Point Operator v6.1](#)

## Device Support

Floating-Point support is restricted to the following devices:

Virtex-7, Kintex-7, Artix<sup>™</sup>-7, Zynq<sup>™</sup>-7000, Virtex-6, Spartan-6



## Single-Step Simulation

*This block is listed in the following Xilinx Blockset libraries: Tools and Index.*



The Xilinx Single-Step Simulation block pauses the simulation each clock cycle when in single-step mode.

Double-clicking on the icon switches the block from single-step to continuous mode. When the simulation is paused, it can be restarted by selecting the **Start** button on the model toolbar .

### Block Parameters

There are no parameters for this block.

## Slice

This block is listed in the following Xilinx Blockset libraries: *Basic Elements, Control Logic, Data Types, and Index*

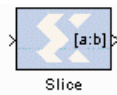

The Xilinx Slice block allows you to slice off a sequence of bits from your input data and create a new data value. This value is presented as the output from the block. The output data type is unsigned with its binary point at zero.

The block provides several mechanisms by which the sequence of bits can be specified. If the input type is known at the time of parameterization, the various mechanisms do not offer any gain in functionality. If, however, a Slice block is used in a design where the input data width or binary point position are subject to change, the variety of mechanisms becomes useful. The block can be configured, for example, always to extract only the top bit of the input, or only the integral bits, or only the first three fractional bits. The following diagram illustrates how to extract all but the top 16 and bottom 8 bits of the input.

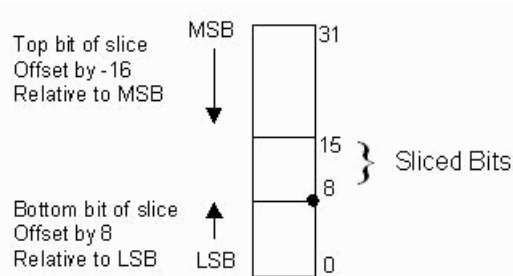

## Block Parameters

The block parameters dialog box can be invoked by double-clicking the icon in your Simulink model.

Parameters specific to the block are as follows:

- **Width of slice (Number of bits):** specifies the number of bits to extract.
- **Boolean output:** Tells whether single bit slices should be type Boolean.
- **Specify range as:** (Two bit locations | Upper bit location + width | Lower bit location + width). Allows you to specify either the bit locations of both end-points of the slice or one end-point along with number of bits to be taken in the slice.
- **Offset of top bit:** specifies the offset for the ending bit position from the LSB, MSB or binary point.
- **Offset of bottom bit:** specifies the offset for the ending bit position from the LSB, MSB or binary point.
- **Relative to:** specifies the bit slice position relative to the Most Significant Bit (MSB), Least Significant Bit (LSB), or Binary point of the top or the bottom of the slice.

Other parameters used by this block are explained in the topic

[Common Options in Block Parameter Dialog Boxes.](#)

# SquareRoot

This block is listed in the following Xilinx Blockset libraries: *Floating-Point, Math and Index*.



The Xilinx SquareRoot block performs the square root on the input. Currently, only the floating-point data type is supported.

## Block Parameters

The block parameters dialog box can be invoked by double-clicking the icon in your Simulink model.

### Basic tab

Parameters specific to the Basic tab are as follows:

Flow Control:

- **Blocking:** Selects “Blocking” mode. In this mode, the lack of data on one input channel does block the execution of an operation if data is received on another input channel.
- **NonBlocking:** Selects “Non-Blocking” mode. In this mode, the lack of data on one input channel does not block the execution of an operation if data is received on another input channel.

### Optional ports

Input Channel Ports

- **Has TLAST:** Adds a TLAST port to the Input channel.
- **Has TUSER:** Adds a TUSER port to the Input channel.
- **Provide enable port:** Adds an enable port to the block interface.
- **Has Result TREADY:** Adds a TREADY port to the Result channel.

Exception Signals

**INVALID\_OP:** Adds an output port that serves as an invalid operation flag.

Other parameters used by this block are explained in the topic [Common Options in Block Parameter Dialog Boxes](#).

## LogiCORE™ Documentation

[LogiCORE IP Floating-Point Operator v6.1](#)

## Device Support

Floating-Point support is restricted to the following devices:

Virtex-7, Kintex-7, Artix™-7, Zynq™-7000, Virtex-6, Spartan-6

## System Generator

This token is listed in the following Xilinx Blockset libraries: *Basic Elements, Tools, and Index*.



The System Generator token serves as a control panel for controlling system and simulation parameters, and it is also used to invoke the code generator for netlisting. Every Simulink model containing any element from the Xilinx Blockset must contain at least one System Generator token. Once a System Generator token is added to a model, it is possible to specify how code generation and simulation should be handled.

For a detailed discussion on how to use the token, see [Compiling and Simulating Using the System Generator Token](#).

### Token Parameters

The parameters dialog box can be invoked by double-clicking the icon in your Simulink model.

#### Compilation tab

Parameters specific to the Compilation tab are as follows:

- **Compilation:** Specifies the type of compilation result that should be produced when the code generator is invoked. See [System Generator Compilation Types](#) for more details.
- **Part:** Defines the FPGA part to be used.
- **Synthesis tool:** Specifies the tool to be used to synthesize the design. The possibilities are Synplicity's Synplify Pro, Synplify, and Xilinx's XST.
- **Hardware Description Language:** Specifies the HDL language to be used for compilation of the design. The possibilities are VHDL and Verilog.
- **Target directory:** Defines where System Generator should write compilation results. Because System Generator and the FPGA physical design tools typically create many files, it is best to create a separate target directory, for example, a directory other than the directory containing your Simulink model files.
- **Project type:** Select which type of project file is to be generated, either Project Navigator or PlanAhead. The generated PlanAhead project file can be found in the hdl\_netlist or bitstream subfolder.
- **Synthesis strategy file:** If PlanAhead Project type is selected, choose a Synthesis strategy from the pre-defined strategies in the drop-down list.
- **Implementation strategy file:** If PlanAhead Project type is selected, choose an Implementation strategy from the pre-defined strategies in the drop-down list.
- **Create testbench:** This instructs System Generator to create a HDL testbench. Simulating the testbench in an HDL simulator compares Simulink simulation results with ones obtained from the compiled version of the design. To construct test vectors, System Generator simulates the design in Simulink, and saves the values seen at gateways. The top HDL file for the testbench is named <name>\_testbench.vhd/.v, where <name> is a name derived from the portion of the design being tested.

**Note:** This option is not supported when shared-memory blocks are included in the design.

- **Create interface document:** When this box is checked and the Generate button is activated for netlisting, System Generator creates an HTM document that describes the design being netlisted. This document is placed in a “documentation” subfolder under the netlist folder.

**Adding Designer Comments to the Generated Document** If you want to add personalized comments to the auto-generated document, follow this procedure:

- As shown below, double click on the Simulink canvas at the top-level and add a comment that starts with **Designer Comments:**

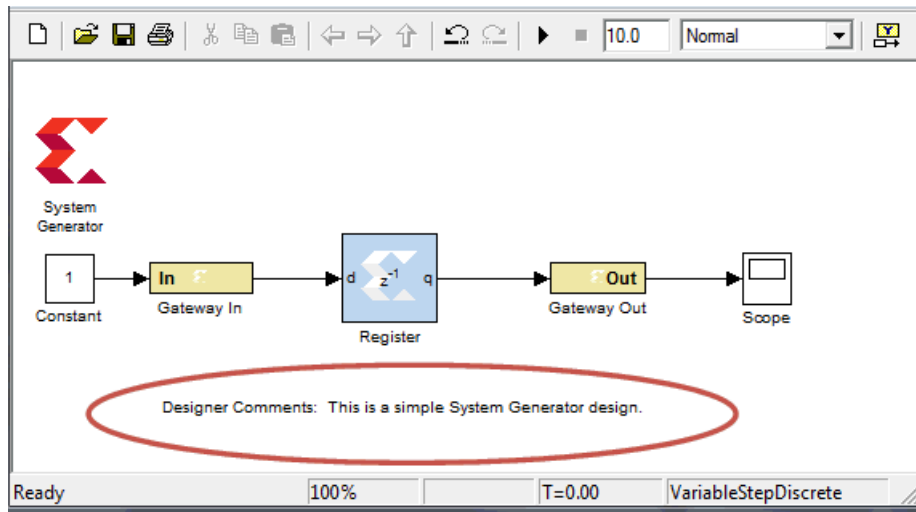

- Double click on the System Generator token, click the **Create interface document** box at the bottom of the Compilation tab, then click **Generate**.
- When netlisting is complete, navigate to the **documentation** subfolder underneath the netlist folder and double click on the HTM document. As shown below, a Designer Comments section is created in the document and your personalized comments are included. **Create**

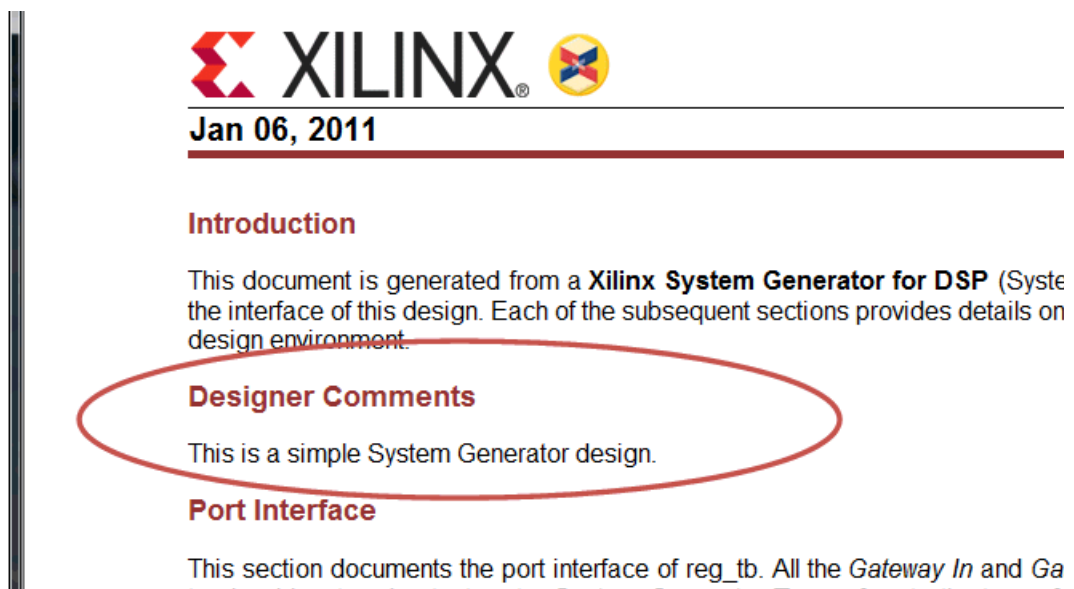

- **Model Upgrade:** Generates a Status Report that helps you identify and upgrade blocks that are not the latest available in the System Generator 14.4/14.5 release. Using this feature is the first step in preparing the model for migration to the Vivado Integrated Design Environment. The preparation sequence is as follows:
  - a. Open the System Generator model in System Generator release 14.4/14.5.

The latest blocks with multiple versions are listed in the table below:

Block Name	Latest Version in ISE
CIC Compiler	CIC Compiler 3.0
CORDIC	CORDIC5.0
Complex Multiplier	Complex Multiplier 5.0
Convolution Encoder	Convolution Encoder 8.0
Divider Generator 4.0	Divider Generator 4.0
DDS Compiler	DDS Compiler 5.0
DSP Macro	DSP Macro 2.1
FIR Compiler	FIR Compiler 6.3
Fast Fourier Transform	Fast Fourier Transform 8.0
Interleaver/De-Interleaver	Interleaver/De-Interleaver 7.1
Reed-Soloman Decoder	Reed-Soloman Decoder 8.0
Viterbi Decoder0	Viterbi Decoder 8.0

- b. Double click on the System Generator token and then click the **Model upgrade** button as shown below:

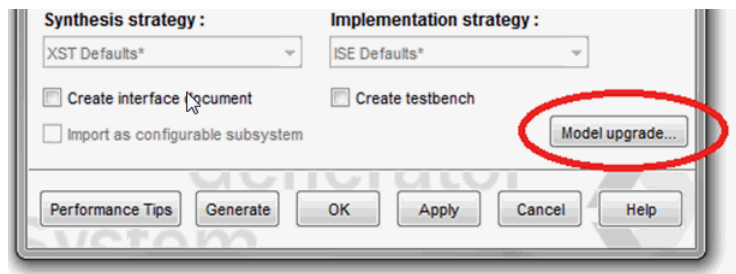

- c. Observe the elements in the generated Status Report, as shown below:

### Upgrade Status Report

Model upgrade flow assists user in migration of old versions of Sysgen blocks to latest available versions in the System Generator design [model\\_upgrade](#).  
Upgradation of blocks to latest version is recommended.

[Upgrade](#) the model.

#### model\_upgrade

This Model has 2 blocks which are superceded. Necessary action is required to maintain the functionality of the design in future releases.

**Upgrade Support** - Specifies the update support of the block

**Replace Support** - Specifies the block replacement and stitching support in the Model

Block name	Block version Used	Block version Available	Upgrade support	Replace support	Perform Upgrade	Action
.../model_upgrade/Complex Multiplier 3.1	3.1	5.0	Yes	No	<a href="#">Upgrade</a>	Required
.../Interleaver//De-interleaver 7.0	7.0	7.1	Yes	Yes	<a href="#">Upgrade</a>	Required

- Two blocks in this the model are upgradable.
- The Interleaver/De-interleaver 7.0 block has full Replace support. When you click [Upgrade](#) in the **Perform Upgrade** column, the single block is upgraded to 7.1.
- The Complex Multiplier 3.1 block does not have full Replace support because moving from the non-AXI 3.1 block to the AXI 5.0 block requires manual intervention. When you click [Upgrade](#) in then column, a sub-system work-space is create where you can manually re-connect the input/out signals to the new AXI ports.

## Clocking tab

Parameters specific to the Compilation tab are as follows:

- **FPGA clock period(ns)**: Defines the period in nanoseconds of the system clock. The value need not be an integer. The period is passed to the Xilinx implementation tools through a constraints file, where it is used as the global PERIOD constraint. Multicycle paths are constrained to integer multiples of this value.
- **Clock pin location**: Defines the pin location for the hardware clock. This information is passed to the Xilinx implementation tools through a constraints file. This option should not be specified if the System Generator design is to be included as part of a larger HDL design.
- **Multirate implementation**:
  - ◆ **Clock Enables (default)**: Creates a clock enable generator circuit to drive the multirate design.
  - ◆ **Hybrid DCM-CE**: Creates a clock wrapper with a DCM that can drive up to three clock ports at different rates for Virtex@-4, and Virtex-5, and up to two clock ports for Spartan-3A DSP. The mapping of rates to the DCM output ports is done using the following priority scheme: CLK0 > CLK2x > CLKdv > CLKfx. If the design contains more clocks than the DCM can handle, the remaining clocks are supported through the Clock Enable configuration.  
 A `reset` input port is exposed on the DCM clock wrapper to allow resetting the DCM and a `locked` output port is exposed to help the external design synchronize the input data with the single `clk` input pin.
  - ◆ **Expose Clock Ports**: This option exposes multiple clock ports on the top-level of the System Generator design so you can apply multiple synchronous clock inputs from outside the design.

Refer to the topic [Timing and Clocking](#) for details

- **DCM input clock period(ns)**: Specify if different than the **FPGA clock period(ns)** option (system clock). The FPGA clock period (system clock) will then be derived from this hardware-defined input.
- **Provide clock enable clear pin**: This instructs System Generator to provide a `ce_clr` port on the top level clock wrapper. The `ce_clr` signal is used to reset the clock enable generation logic. Capability to reset clock enable generations logic allows designs to have dynamic control for specifying the beginning of data path sampling. See [Resetting Auto-Generated Clock Enable Logic](#) for details.
- **Simulink system period(sec)**: Defines the Simulink System Period, in units of seconds. The Simulink system period is the greatest common divisor of the sample periods that appear in the model. These sample periods are set explicitly in the block dialog boxes, inherited according to Simulink propagation rules, or implied by a hardware oversampling rate in blocks with this option. In the latter case, the implied sample time is in fact faster than the observable simulation sample time for the block in Simulink. In hardware, a block having an oversampling rate greater than one processes its inputs at a faster rate than the data. For example, a sequential multiplier block with an over-sampling rate of eight implies a (Simulink) sample period that is one eighth of the multiplier block's actual sample time in Simulink. This parameter can be modified only in a master block.

## General tab

Parameters specific to the General tab are as follows:



- **Block icon display:** Specifies the type of information to be displayed on each block icon in the model after compilation is complete. The various display options are described below:
  - ◆ **Default:** Displays the default block icon information on each block in the model. A blocks's default icon is derived from the xbsIndex library.

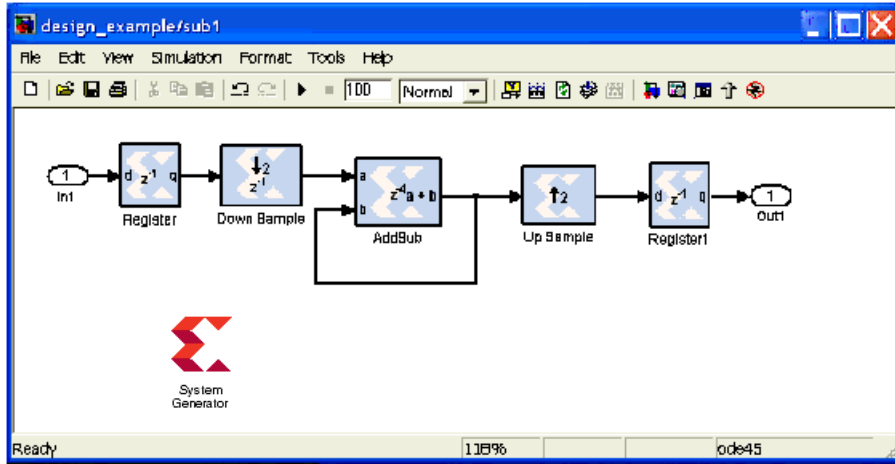

- ◆ **Normalized Sample Periods:** Displays the normalized sample periods for all the input and output ports on each block. For example, if the Simulink System Period is set to 4 and the sample period propagated to a block port is 4 then the normalized period that is displayed for the block port is 1 and if the period propagated to the block port is 8 then the sample period displayed would be 2 for example, a larger number indicates a slower rate.

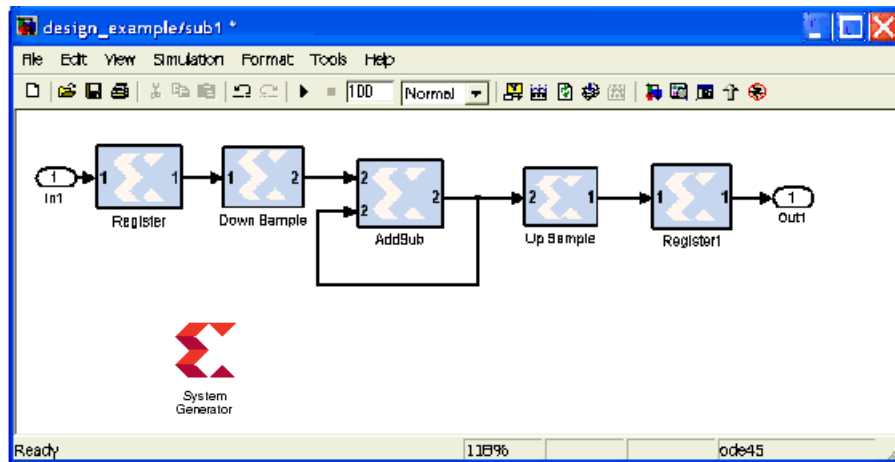

- ◆ **Sample frequencies (Mhz):** Displays sample frequencies for each block.
- ◆ **Pipeline stages:** Displays the latency information from the input ports of each block. The displayed pipeline stage might not be accurate for certain high-level blocks such as the FFT, RS Encoder/ Decoder, Viterbi Decoder, etc. In this case the displayed pipeline information can be used to determine whether a block has a combinational path from the input to the output. For example, the Up Sample block in the figure below shows that it

has a combinational path from the input to the output port.

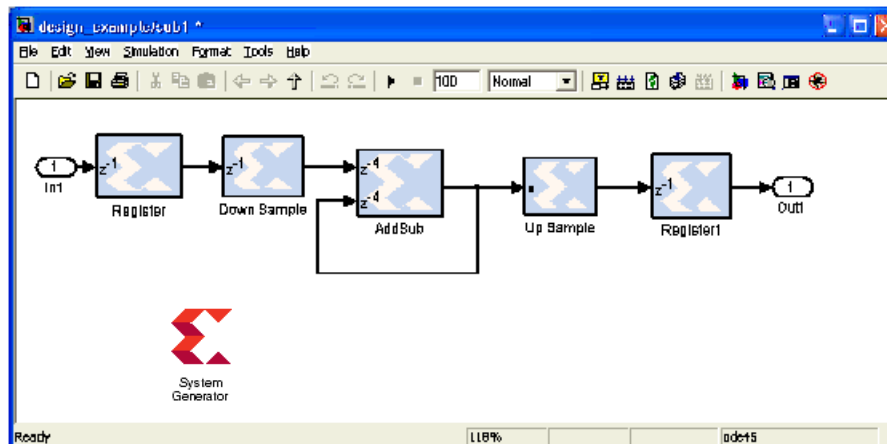

- ◆ **HDL port names:** Displays the HDL port name of each port on each block in the model.
- ◆ **Input data types:** Displays the data type of each input port on each block in the model.
- ◆ **Output data types:** Displays the data type of each output port on each block in the model.

## Threshold

*This block is listed in the following Xilinx Blockset libraries: Basic Elements, Data Types, Math and Index.*



The Xilinx Threshold block tests the sign of the input number. If the input number is negative, the output of the block is -1; otherwise, the output is 1. The output is a signed fixed-point integer that is 2 bits long. The block has one input and one output.

### Block Parameters

The block parameters dialog box can be invoked by double-clicking the icon in your Simulink model.

Parameters used by this block are explained in the topic [Common Options in Block Parameter Dialog Boxes](#).

The block parameters do not control the output data type because the output is always a signed fixed-point integer that is 2 bits long.

### Xilinx LogiCORE

The Threshold block does not use a Xilinx LogiCORE™.

## Time Division Demultiplexer

This block is listed in the following Xilinx Blockset libraries: *Basic Elements and Index*.

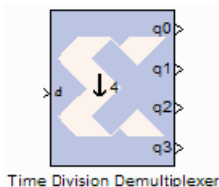

The Xilinx Time Division Demultiplexer block accepts input serially and presents it to multiple outputs at a slower rate.

### Block Interface

The block has one data input port and a user-configurable number of data outputs, ranging from 1 to 32. The data output ports have the same arithmetic type and precision as the input data port. The time division demultiplexer block also has optional input-valid port (vin) and output-valid port (vout). Both the valid ports are of type Bool. The block has two possible implementations, single or multiple channel.

### Single Channel Implementation

For single channel implementation, the time division demultiplexer block has one data input and output port. Optional data valid input and output ports are also allowed. The length of the frame sampling pattern establishes the length of the input data frame. The position of 1 indicates the input value to be downsampled and the number of 1's correspond to the downsampling factor. The behavior of the demultiplexer block in single channel mode can best be illustrated with the help of the figure below. Based on the frame sampling pattern entered, the first and second input values of every input data frame are sampled and presented to the output at the rate of 2.

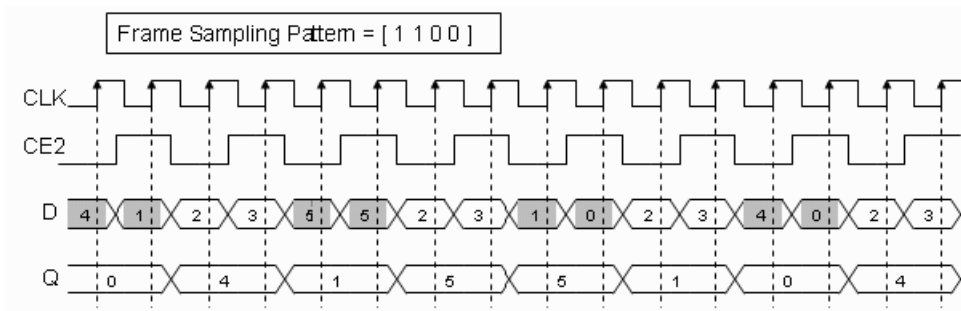

For single channel implementation, the number of values to be sampled from a data frame should evenly divide the size of the input frame. Every input data frame value can also be qualified by using the optional valid port.

### Multiple Channel Implementation

For multiple channel implementation, the time division demultiplexer block has one data input port and multiple output ports equal to the number of 1's in the frame sampling pattern. Optional data valid input and output ports are also allowed. The length of the frame sampling pattern establishes the length of the input data frame. The position of 1 indicates the input value to be downsampled and presented to the corresponding output data channel. The behavior of the demultiplexer block in multiple channel mode can best be illustrated with the help of the figure below. Based on the frame sampling pattern entered, the first and second input values of every input data frame are sampled and presented to the corresponding output channel at the rate of 4.

For multiple channel implementation, the down sampling factor is always equal to the size of the input frame. Every input data frame value can also be qualified by using the optional valid port.

## Block Parameters

The block parameters dialog box can be invoked by double-clicking the icon in your Simulink model.

Parameters specific to this block are:

- **Frame sampling pattern:** specifies the size of the serial input data frame. The frame sampling pattern must be a MATLAB vector containing only 1's and 0's.
- **Implementation:** specifies the demultiplexer behavior to be either in single or multiple channel mode. The behaviors of these modes are explained above.
- **Provide valid Port:** when selected, the demultiplexer has optional input and output valid ports (vin / vout). The vin port allows to qualify every input data value as part of the serial input data frame. The vout port marks the state of the output ports as valid or not.

Parameters used by this block are explained in the topic [Common Options in Block Parameter Dialog Boxes](#).

## Time Division Multiplexer

This block is listed in the following Xilinx Blockset libraries: *Basic Elements and Index*.

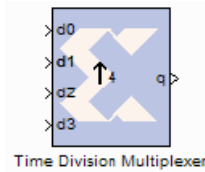

The Xilinx Time Division Multiplexer block multiplexes values presented at input ports into a single faster rate output stream.

### Block Interface

The block has two to 32 input ports and one output port. All input ports must have the same arithmetic type, precision, and rate. The output port has the same arithmetic type and precision as the inputs. The output rate is  $nr$ , where  $n$  is the number of input ports and  $r$  is their common rate. The block also has optional ports  $vin$  and  $vout$  that specify when input and output respectively are valid. Both valid ports are of type Bool.

### Block Parameters

The block parameters dialog box can be invoked by double-clicking the icon in your Simulink model.

Parameters specific to the block are as follows:

- **Number of Inputs:** specifies the number of inputs (2 to 32).
- **Provide valid Port:** when selected, the multiplexer is augmented with input and output valid ports named  $vin$  and  $vout$  respectively. When the  $vin$  port indicates that input values are invalid, the  $vout$  port indicates the corresponding output frame is invalid

Parameters used by this block are explained in the topic [Common Options in Block Parameter Dialog Boxes](#).

## To FIFO

This block is listed in the following Xilinx Blockset libraries: *Floating-Point, Index*.

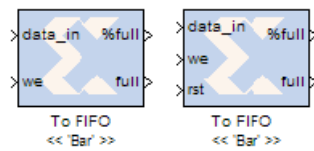

The Xilinx To FIFO block implements the leading half of a first-in-first-out memory queue.

Values presented at the module's data port are written to the next available empty memory location when we input is one. The full output port is asserted when the FIFO is full. The percent full output port indicates the percentage of the FIFO that is full, represented with user-specified precision.

The To FIFO is implemented in hardware using the FIFO Generator LogiCORE. System Generator's hardware co-simulation interfaces allow the To FIFO block to be compiled and co-simulated in FPGA hardware. When used in System Generator co-simulation hardware, shared FIFOs facilitate high-speed transfers between the host PC and FPGA, and bolster the tool's real-time hardware co-simulation capabilities.

Each pair of **From FIFO** and **To FIFO** blocks with the same name are stitched together as a BRAM-based **FIFO** block in the netlist. If a **From FIFO** or **To FIFO** block does not form a pair with another block, its input and output ports are pushed to the top level of System Generator design. A pair of matching blocks can exist anywhere in the hierarchy of the design, however, if two or more **From FIFO** or **To FIFO** blocks with the same name exist in the design, then an error is issued.

For backward compatibility, you can set the MATLAB global variable `xlSgSharedMemoryStitch` to "off" to bring System Generator back to the netlisting behavior before the 9.2 release. For example, from the MATLAB command line, enter the following:

```
global xlSgSharedMemoryStitch;
xlSgSharedMemoryStitch = 'off';
```

**Note:** The notion of bit and cycle accuracy is preserved only within individual synchronous islands. The shared FIFO block supports crossing clock domain boundaries and bit and cycle accuracy may not be maintained.

## Block Parameters

### Basic tab

Parameters specific to the Basic tab are as follows:

- **Shared memory name:** name of the shared FIFO. All FIFOs with the same name share the same physical FIFO.
- **Ownership:** indicates whether the memory is Locally owned or Owned elsewhere. A block that is Locally owned is responsible for creating an instance of the FIFO. A block that is Owned elsewhere attaches itself to a FIFO instance that has already been created.

### FIFO Implementation

**Memory Type:** This block implements FIFOs built from block RAM, distributed RAM, shift registers, or the 7 series, Virtex-6 and Virtex-5 FPGA built-in FIFOs. Memory primitives are

arranged in an optimal configuration based on the selected width and depth of the FIFO. The following table provides best-use recommendations for specific design requirements.

	Independent Clocks	Common Clock	Small Buffering	Medium-Large Buffering	High Performance	Minimal] Resources
Zynq-7000, 7 Series, Virtex-6, and Virtex-5 FPGA with Built-in FIFO	✓	✓		✓	✓	✓
Block RAM	✓	✓		✓	✓	✓
Shift Register		✓	✓		✓	
Distributed RAM	✓	✓	✓		✓	

#### Performance Options:

- **Standard FIFO:** FIFO will operate in Standard Mode.
- **First Word Fall Through:** FIFO will operate in First-Word Fall-Through (FWFT) mode. The First-Word Fall-Through feature provides the ability to look-ahead to the next word available from the FIFO without issuing a read operation. When data is available in the FIFO, the first word falls through the FIFO and appears automatically on the output. FWFT is useful in applications that require low-latency access to data and to applications that require throttling based on the contents of the data that are read. FWFT support is included in FIFOs created with block RAM, distributed RAM, or built-in FIFOs in the 7 series, Virtex-6 or Virtex-5 devices.

#### Implementation Options:

- Use Embedded Registers (when possible):  
In 7 series, Virtex-6, Virtex-5 and Virtex-4 FPGA block RAM and FIFO macros, embedded output registers are available to increase performance and add a pipeline register to the macros. This feature can be leveraged to add one additional cycle of latency to the FIFO core (DOUT bus and VALID outputs) or implement the output registers for FWFT FIFOs. The embedded registers available in 7 series, and Virtex-6 FPGAs can be reset (DOUT) to a default or user programmed value for common clock built-in FIFOs. See the topic **Embedded Registers in block RAM and FIFO Macros** in the [LogiCORE IP FIFO Generator v9.2 Product Specification](#).

**Depth:** specifies the number of words that can be stored. Range 16-64K.

**Bits of precision to use for %full signal:** specifies the bit width of the %full port. The binary point for this unsigned output is always at the top of the word. Thus, if for example precision is set to one, the output can take two values: 0.0 and 0.5, the latter indicating the FIFO is at least 50% full.

#### Optional Ports:

- **Provide asynchronous reset port:** Activates an optional asynchronous edge-triggered reset (rst) port on the block. Prior to Release 11.2, this reset was level-triggered and the block would remain in the reset mode if held high.
- **Provide percent full port:** Add a percent full output port to the block. Indicates the percentage of the FIFO that is full using the user-specified precision. This optional port is turned on by default for backward compatibility reasons.



## Output tab

### Output Type

- Specifies the data type of the output. Can be **Fixed-point** or **Floating-point**.  
Arithmetic Type: If the Output Type is specified as Fixed-point, you can select **Signed (2's comp)** or **Unsigned** as the Arithmetic Type.

#### Fixed-point Precision

- ◆ **Number of bits:** specifies the bit location of the binary point of the output number, where bit zero is the least significant bit.
- ◆ **Binary point:** position of the binary point. in the fixed-point output

#### Floating-point Precision

- ◆ **Single:** specifies single precision (32 bits)

Parameters in this tab are explained in the topic [Common Options in Block Parameter Dialog Boxes](#).

## LogiCORE™ Documentation

[LogiCORE IP FIFO Generator 9.2](#)

[LogiCORE IP Floating-Point Operator v6.1](#)

## Device Support

Zynq-7000, Artix-7, Virtex-7, Kintex-7, Virtex-6, Virtex-5, Virtex-4, Spartan-6, Spartan-3A/3AN/3A DSP, Spartan-3E, Spartan-3

Floating-Point support is restricted to the following devices:

Virtex-7, Kintex-7, Artix-7, Zynq-7000, Virtex-6, Spartan-6

## See Also

[From FIFO](#)

## To Register

This block is listed in the following Xilinx Blockset libraries: *Floating-Point and Index*.



The Xilinx To Register block implements the leading half of a D flip-flop based register, having latency of one sample period. The register can be shared among multiple designs or sections of a design.

The block has two input ports. The `din` port accepts input data and sets the bit width of the register. The initial output value is specified by you in the block parameters dialog box (below). When the enable port `en` is asserted, data presented at the input appears at the output `dout` after one sample period. When `en` is not asserted, the last value written to the register is presented to the output port `dout`.

Starting with the 9.2 release, during netlisting, each pair of **To Register** and **From Register** blocks with the same name are stitched together as a single **Register** block in the netlist. If a **To Register** or **From Register** block does not form a pair with another block, its input and output ports are pushed to the top level of System Generator design. A pair of matching blocks can exist anywhere in the hierarchy of the design, however, if two or more **To Register** or **From Register** blocks with the same name exist in the design, then an error is issued.

For backward compatibility, you can set the MATLAB global variable `xlSgSharedMemoryStitch` to “off” to bring System Generator back to the netlisting behavior before the 9.2 release. For example, from the MATLAB command line, enter the following:

```
global xlSgSharedMemoryStitch;
xlSgSharedMemoryStitch = 'off';
```

### Block Parameters

The block parameters dialog box can be invoked by double-clicking the icon in your Simulink model.

#### Basic tab

Parameters specific to the Basic tab are as follows:

- **Shared memory name:** name of the shared register. There must be exactly one To Register block for a particular physical register. In addition, the shared memory name must be distinct from all other shared memory names in the design.
- **Initial value:** specifies the initial value in the register.
- **Ownership and initialization:** indicates whether the register is Locally owned and initialized or Owned and initialized elsewhere. A block that is locally owned is responsible for creating an instance of the register. A block that is owned elsewhere attaches itself to a register instance that has already been created. As a result, if two shared register blocks are used in two different models during simulation, the model containing the locally owned block has to be started first.

## Output tab

Specify explicit output precision

### Output Precision

- Specifies the data type of the output. Can be **Fixed-point** or **Floating-point**.

Arithmetic Type: If the Output Type is specified as Fixed-point, you can select **Signed (2's comp)** or **Unsigned** as the Arithmetic Type.

#### Fixed-point Precision

- ◆ **Number of bits:** specifies the bit location of the binary point of the output number, where bit zero is the least significant bit.
- ◆ **Binary point:** position of the binary point. in the fixed-point output

#### Floating-point Precision

- ◆ **Single:** specifies single precision (32 bits)

Parameters used by this block are explained in the topic [Common Options in Block Parameter Dialog Boxes](#).

## Crossing Clock Domains

When a To Register and From Register block pair are used to cross clock domain boundaries, a single register is implemented in hardware. This register is clocked by the To Register block clock domain. For example, assume a design has two clock domains, Domain\_A and Domain\_B. Also assume that a shared register pair are used to cross the two clock domains shown below.

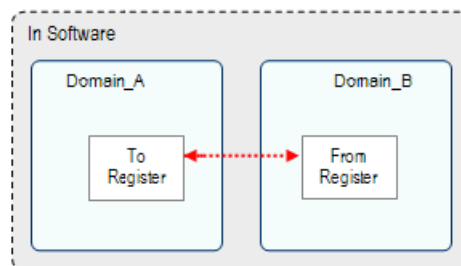

When the design is generated using the Multiple Subsystem Generator block, only one register is included in the design. The clock and clock enable register signals are driven from the Domain\_A domain.

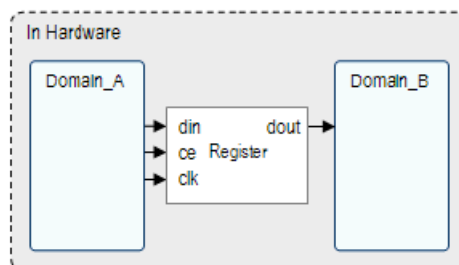

Crossing domains in this manner can be unsafe. To reduce the chance of metastability, include two Register blocks immediately following the From Register block to re-synchronize the data to the From Register's clock domain.

## LogiCORE™ Documentation

[LogiCORE IP Floating-Point Operator v6.1](#)

## Device Support

Floating-Point support is restricted to the following devices:

Virtex-7, Kintex-7, Artix™-7, Zynq™-7000, Virtex-6, Spartan-6

## See Also

The following topics provide valuable insight into using and understanding the To Register block:

[Gateway In](#)

# Toolbar

This block is listed in the following Xilinx Blockset libraries: *Tools and Index*.



The Xilinx Toolbar block provides quick access to several useful utilities in System Generator. The Toolbar simplifies the use of the zoom feature in Simulink and adds new auto layout and route capabilities to Simulink models.

The Toolbar also houses several productivity improvement tools described below.

## Block Interface

Double clicking on the Xilinx Toolbar block launches the GUI shown below.

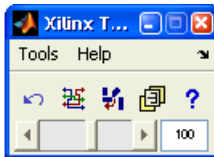



The Toolbar can also be launched from the command line using `xlTBUtils`, a collection of functions used by the Toolbar.

```
xlTBUtils('Toolbar');
```

Only one Toolbar GUI can be opened at a time, that is, the Toolbar GUI is a singleton. Regardless of where a Toolbar block is placed, the Toolbar will always perform actions on the current Simulink model in focus. In other words, if the Toolbar is invoked from model A, it can still be used on model B so long as model B is in focus.

## Toolbar Buttons

Toolbar Buttons	Descriptions
	<b>Undo:</b> Cancels the most recent change applied to the model layout by the Toolbar and reverts the layout state to the one prior to this change. Can undo up to three changes.
	<b>Reroute:</b> Reroutes lines to enhance model readability. If lines are selected, only those lines are rerouted. Otherwise all lines in the model are rerouted.
	<b>Auto Layout:</b> Relocates blocks and reroutes lines to enhance model readability.
	<b>Add Terms:</b> Calls on the <code>xlAddTerms</code> function to add sources and sinks to the current model in focus. System Generator blocks are sourced with a System Generator constant block, while Simulink blocks are sourced with a Simulink constant block. Terminators are used as sinks.

Toolbar Buttons	Descriptions
	<b>Help:</b> Opens this document.
	<b>Zoom:</b> Allows you to get either a closer view of a portion of the Simulink model or a wider view of the model depending on the position of the slider or the value of the zoom factor. You can either position the slider or edit the Zoom Factor. The Zoom Factor is limited to be between 5 and 1000.

## Toolbar Menus

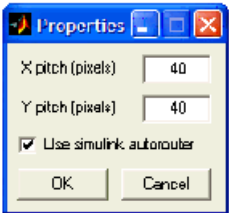
Toolbar Buttons	Descriptions
Tools	
Create Plugins	Launches the System Generator Board Description Builder tool.
Inspect Selected	Opens up the Simulink Inspector with the properties of the blocks that are currently selected. This is useful when trying to set the size of several blocks, or the horizontal position of blocks drawn on a model.
Toolbar Properties	<p>Launches the Properties Dialog Box shown in the figure below. Allows you to set parameters for the Auto Layout and Reroute tool. X and Y pitch indicate distances (in pixels) between blocks placed next to each other in the X and Y directions respectively.</p> <p>The toolbar uses the Simulink autorouter when <b>Use simulink autorouter</b> is checked. Otherwise, a direct line is drawn from source to destination.</p> 
Help	Opens this document.

## References

- 1) E.R.Gansner, E.Koutsofios, S.C.North, KVo, "A Technique for Drawing Directed Graphs", <http://www.graphviz.org/Documentation/TSE93.pdf>
- 2) The **Reroute** and **Auto Layout** buttons invoke an open source package called Graphviz. More information on this package is also available at <http://www.graphviz.org/>

## See Also

[xlAddTerms](#), [xlSBDBuilder](#), [xlTBUtills](#)

# Up Sample

This block is listed in the following Xilinx Blockset libraries: Basic Elements and Index.

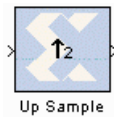

The Xilinx Up Sample block increases the sample rate at the point where the block is placed in your design. The output sample period is  $1/n$ , where  $l$  is the input sample period and  $n$  is the sampling rate.

The input signal is up sampled so that within an input sample frame, an input sample is either presented at the output  $n$  times if samples are copied, or presented once with  $(n-1)$  zeroes interspersed if zero padding is used.

In hardware, the Up Sample block has two possible implementations. If the Copy Samples option is selected on the block parameters dialog box, the Din port is connected directly to Dout and no hardware is expended. Alternatively, if zero padding is selected, a mux is used to switch between the input sample and inserted zeros. The corresponding circuit for the zero padding Up Sample block is shown below.

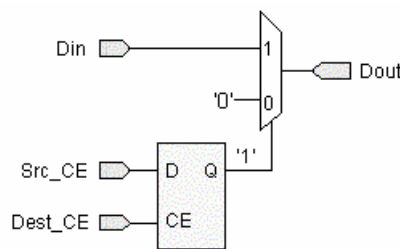

## Block Interface

The Up Sample block receives two clock enable signals, Src\_CE and Dest\_CE. Src\_CE is the clock enable signal corresponding to the input data stream rate. Dest\_CE is the faster clock enable, corresponding to the output data stream rate. Notice that the circuit uses a single flip-flop in addition to the mux. The flip-flop is used to adjust the timing of Src\_CE, so that the mux switches to the data input sample at the start of the input sample period, and switches to the constant zero after the first input sample. It is important to notice that the circuit has a combinational path from Din to Dout. As a result, an Up Sample block configured to zero pad should be followed by a register whenever possible.

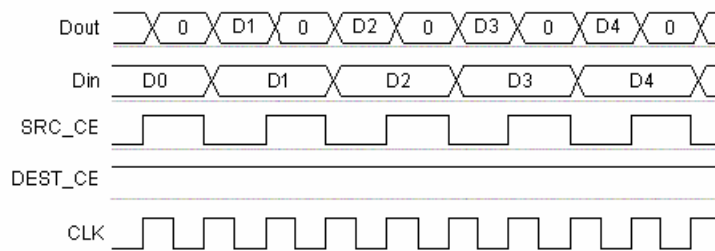

## Block Parameters

The block parameters dialog box can be invoked by double-clicking the icon in your Simulink model.

### Basic tab

Parameters specific to the Basic tab are as follows:

- **Sampling rate (number of output samples per input sample):** must be an integer with a value of 2 or greater. This is the ratio of the output sample period to the input, and is essentially a sample rate multiplier. For example, a ratio of 2 indicates a doubling of the input sample rate. If a non-integer ratio is desired, the Up Sample block can be used in combination with the Down Sample block.
- **Copy samples (otherwise zeros are inserted):** allows you to choose what to do with the additional samples produced by the increased clock rate. By selecting Copy Samples, the same sample is duplicated (copied) during the extra sample times. If this checkbox is not selected, the additional samples are zero.

### Optional Ports

- ◆ **Provide enable port.** When checked, this option adds an en(enable) input port, if the Latency is specified as a positive integer greater than zero.
- **Latency:** This defines the number of sample periods by which the block's output is delayed. One sample period can correspond to multiple clock cycles in the corresponding FPGA implementation (for example, when the hardware is over-clocked with respect to the Simulink model). The user defined sample latency is handled in the Upsample block by placing shift registers that are clock enabled at the input sample rate, on the input of the block. The behavior of an Upsample block with non-zero latency is similar to putting a delay block, with equivalent latency, at the input of an Upsample block with zero latency.

Parameters used by this block are explained in the topic [Common Options in Block Parameter Dialog Boxes](#).



# VDMA Interface 4.0

This block is listed in the following Xilinx Blockset libraries: AXI4, Index and Memory.

> vdma_1_s_axi_tbe_avalid	
> vdma_1_s_axi_tbe_awaddr	vdma_1_s_axi_tbe_awready
> vdma_1_s_axi_tbe_awvalid	vdma_1_s_axi_tbe_wready
> vdma_1_s_axi_tbe_wvalid	vdma_1_s_axi_tbe_bresp
> vdma_1_s_axi_tbe_wdata	vdma_1_s_axi_tbe_bvalid
> vdma_1_s_axi_tbe_bready	vdma_1_s_axi_tbe_aready
> vdma_1_s_axi_tbe_rvalid	vdma_1_s_axi_tbe_rvalid
> vdma_1_s_axi_tbe_rdata	vdma_1_s_axi_tbe_rdata
> vdma_1_s_axi_tbe_rresp	vdma_1_s_axi_tbe_rresp
> vdma_1_s_axi_tbe_araddr	vdma_1_s_axi_s2mm_tready
> vdma_1_s_axi_tbe_aready	vdma_1_m_axis_mm2s_tdata
> vdma_1_s_axi_s2mm_tdata	vdma_1_m_axis_mm2s_tkeep
> vdma_1_s_axi_s2mm_tkeep	vdma_1_m_axis_mm2s_tvalid
> vdma_1_s_axi_s2mm_tvalid	vdma_1_m_axis_mm2s_tlast
> vdma_1_s_axi_s2mm_tlast	vdma_1_m_axi_sg_araddr
> vdma_1_m_axis_mm2s_tready	vdma_1_m_axi_sg_arlen
> vdma_1_m_axi_sg_araddr	vdma_1_m_axi_sg_arsize
> vdma_1_m_axi_sg_arlen	vdma_1_m_axi_sg_arburst
> vdma_1_m_axi_sg_arburst	vdma_1_m_axi_sg_arprot
> vdma_1_m_axi_sg_arprot	vdma_1_m_axi_sg_arcache
> vdma_1_m_axi_sg_arcache	vdma_1_m_axi_sg_avalid
> vdma_1_m_axi_sg_avalid	vdma_1_m_axi_sg_aready
> vdma_1_m_axi_sg_aready	vdma_1_m_axi_sg_ready
> vdma_1_m_axi_sg_ready	vdma_1_mm2s_inticnt
> vdma_1_mm2s_inticnt	vdma_1_mm2s_tsync_out
> vdma_1_mm2s_tsync_out	vdma_1_mm2s_pmitr_update
> vdma_1_mm2s_pmitr_update	vdma_1_s2mm_inticnt
> vdma_1_s2mm_inticnt	vdma_1_s2mm_tsync_out
> vdma_1_s2mm_tsync_out	vdma_1_s2mm_pmitr_update
> vdma_1_s2mm_pmitr_update	
> vdma_1_axi_resetn	

VDMA Interface 4.0

The VDMA (Video Direct Memory Access) Interface block is a bit-accurate simulation model containing up to 4 AXI VDMA IP LogiCOREs connected to an AXI interconnect and external memory.

As shown in the illustration below, the VDMA Interface block's AXI memory-mapped interface is connected to the AXI Interconnect. DDR external memory is connected as the only slave on the AXI Interconnect. All ports except memory-mapped ports of the VDMA block are available on the VDMA Interface block.

This block is also supported by the Hardware Co-Simulation flow. The supported boards are SP601, SP605 and ML605 and Kintex 7.

The block can now be configured using 'Scatter Gather Engine' mode as well as 'Direct Register' mode.

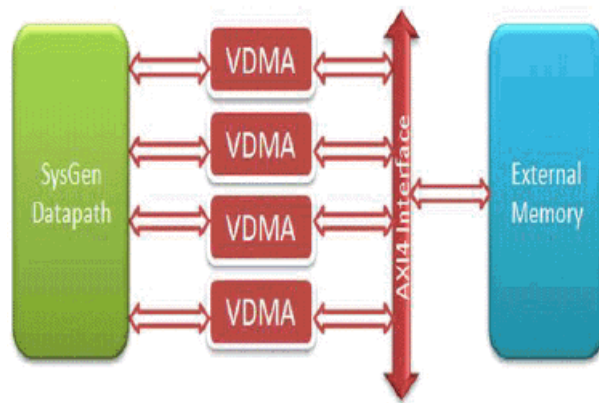

The VDMA Interface block is a simulation-only model and when the netlist is generated, only the block interface is netlisted as top-level gateways. A [xIVDMACreateProject utility](#) is provided that takes a design with a VDMA Interface block and creates an ISE project with a top-level module that stitches the System Generator design with an XPS sub-module that instantiates the actual VDMA, AXI interconnect, and MIG IP.

**Note:** In the simulation model, the memory contents are initialized to 0, however, the memory in the actual hardware might not be initialized to 0 unless you add hardware that does the initialization.

## Preparing to Use This Block

1. Please read the AXI Video Direct Memory Access (axi\_vdma) Product Guide to become familiar with the behavior of the LogiCORE before using this block. AXI Video Direct Memory Access (axi\_vdma) v4.00.a Product Guide)

At the minimum, you should read the following information which is taken from the product Guide:

**AXI VDMA Operation** (pages 101).

Four minimum steps starting on page 101 have to be implemented in the form of either M-Code or discrete logic decoders. This section describes you how to specify valid pointers and control information to control registers as follows:

- Write a valid pointer to the channel's CURDESC\_PNTR register (Offset 0x08 for MM2S and 0x38 for S2MM).
- Write control information to the channel's DMACR register (Offset 0x00 for MM2S and 0x30 for S2MM) to set interrupt enables if desired, frame count, delay count if desired, and set DMACR.RS=1 to start the AXI VDMA channel running. Note there might be a lag between when DMACR.RS=1 and when DMASR.Halted = 0. The AXI VDMA is running when DMACR.RS = 1 and DMASR.Halted = 0.
- Write a valid pointer to the channel's TAILDESC\_PNTR register (Offset 0x10 for MM2S and 0x40 for S2MM). This will start the channel fetching and processing descriptors.
- DMA scatter gather operations will continue until the descriptor at TAILDESC\_PNTR is processed, then the engine will Idle as indicated by DMASR.Idle = 1.

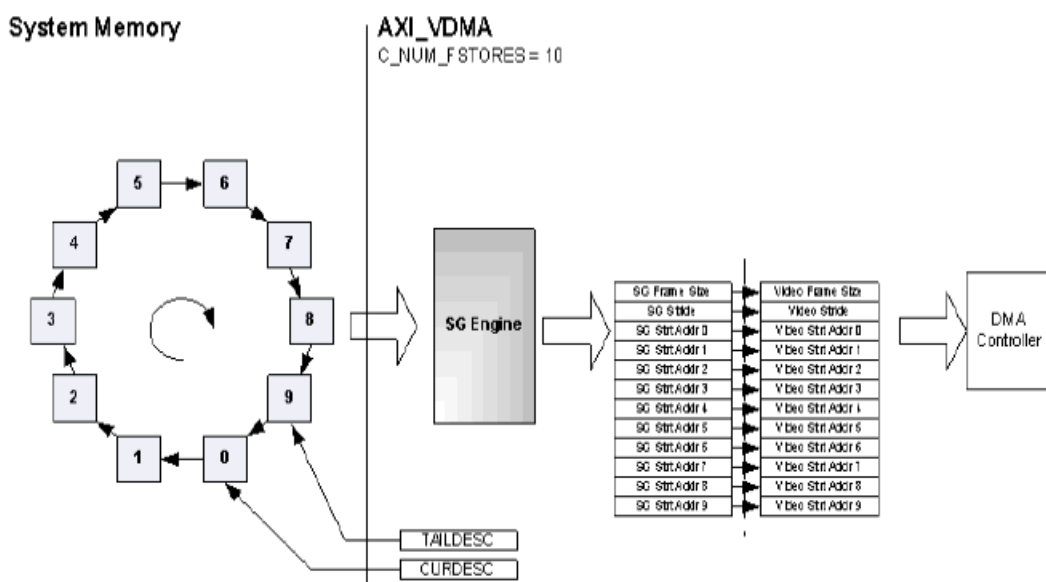

For MM2S and S2MM channels the descriptor chain must be made up of a MM2S\_Frame\_Store and S2MM\_Frame\_Store descriptors respectively. By default on power up and after reset (soft or hard) MM2S\_Frame\_Store and S2MM\_Frame\_Store registers are updated with the value specified by C\_NUM\_FSTORES. The SG Engine will fetch descriptors and update an internal register set with the descriptor information. The video timing information (vsize, hsize, stride, and frame delay) from the first descriptor fetched after the TAILDESC pointer is written by the CPU is captured and stored. All other video timing information in the other descriptors are ignored by the AXI VDMA. Start Addresses from each descriptor are populated into MM2S\_Frame\_Store and S2MM\_Frame\_Store internal address registers

### Scatter Gather Descriptor (page 98)

When AXI VDMA is configured for Scatter/Gather Mode (C\_INCLUDE\_SG = 1), the Scatter Gather engine is used to pull in video transfer control information. This is accomplished by defining a linked list of transfer control information referred to as a descriptor chain in system memory. A descriptor chain is required for each channel. The descriptor chain should be made up of MM2S\_FRMSTORE and S2MM\_FRMSTORE descriptors, respectively, where each descriptor is made up of seven 32-bit words. Each descriptor fields. For Register Direct Mode (C\_INCLUDE\_SG = 0) the Scatter Gather engine is excluded and the video parameter and start

address registers are accessed through the AXI4-Lite Control Interface.

**Note:** Descriptors must be aligned on 8 32-bit word alignment. Example valid offsets are 0x00, 0x20, 0x40, 0x60, and so on.

Address Space Offset <sup>(1)</sup>	Name	Description
00h	NXTDESC	Next Descriptor Pointer points to the first word of the next descriptor to fetch
04h	RESERVED	N/A
08h	START_ADDRESS	Start Address points to the starting pixel to transfer for the given frame
0Ch	RESERVED	N/A
10h	VSIZE	Vertical Size specifies the number of video lines to transfer for the given frame
14h	HSIZE	Horizontal Size specifies the size in bytes of the horizontal line to transfer for a given frame
18h	FRMDLY_STRIDE	Stride specifies the number of bytes between the first pixels of each horizontal line. Frame Delay specifies the number of frames a Gen-Lock slave should be behind the Gen-Lock Master

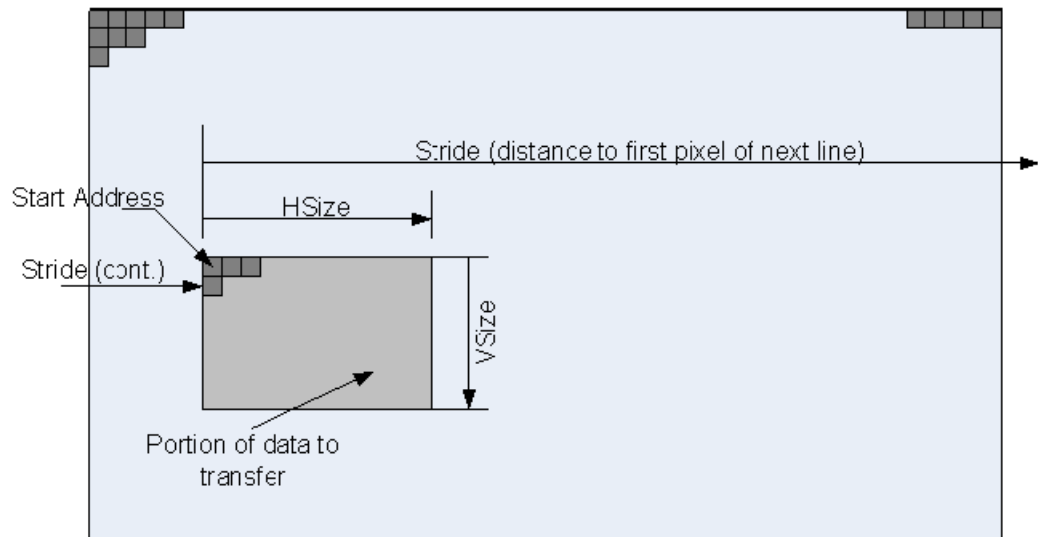

**VDMA Operations in Non Scatter Gather Mode (C\_INCLUDE\_SG = 0)**

The following lists minimum steps, in order, required to being AXI VDMA operations in Non-Scatter Gather Mode:

**Starting VDMA Operations**

- a. Write control information to channel’s DMACR register (Offset 0x00 for MM2S and 0x30 for S2MM) to set interrupt enables if desired, frame count, delay count if desired, and set DMACR.RS=1 to start the AXI VDMA channel running. Note there might be a lag between when the CPU sets DMACR.RS=1 and when AXI VDMA sets DMASR.Halted = 0. The CPU can determine if the AXI VDMA is running when DMACR.RS = 1 and DMASR.Halted = 0.
- b. Write MM2S\_FRAME\_STORE or S2MM\_FRAME\_STORE start addresses to the associated channel.
- c. Write the Frame Delay, Stride, and Horizontal Size in any order for the associated channel.

- d. Finally, write the Vertical Size. This will start VDMA operations for the associated channel.

**AXI VDMA register mapping for Scatter Gather Mode (C\_INCLUDE\_SG = 1)**

AXI VDMA (C_INCLUDE_SG = 1)	
00	MM2S_DMACR
04	MM2S_DMASR
08	MM2S_CURDESC
0C	Reserved
10	MM2S_TAILDESC
14	Reserved
18	MM2S_FRMSTORE
1C	MM2S_THRESHOLD
20	Reserved
24	Reserved
28	PARK_PTR_REF
2C	VDMA Version
30	S2MM_DMACR
34	S2MM_DMASR
38	S2MM_CURDESC
3C	Reserved
40	S2MM_TAILDESC
44	Reserved
48	S2MM_FRMSTORE
4C	S2MM_THRESHOLD

AXI VDMA register mapping for Non-Scatter Gather Mode (C\_INCLUDE\_SG =0)

AXI VDMA (C_INCLUDE_SG = 0)		AXI VDMA (Continued) (C_INCLUDE_SG = 0)	
00	MM2S_DMACR	50	MM2S VSIZE
04	MM2S_DMASR	54	MM2S HSIZE
08	MM2S_CURDESC	58	MM2S FRMDLY / STRIDE
0C	Reserved	5C	MM2S START ADDRESS1
10	MM2S_TAILDESC	60	MM2S START ADDRESS2
14	Reserved	64	MM2S START ADDRESS3
18	MM2S_FRMSTORE	68	MM2S START ADDRESS4
1C	MM2S_THRESHOLD	6C	MM2S START ADDRESS5
20	Reserved	70	MM2S START ADDRESS6
24	Reserved	74	MM2S START ADDRESS7
28	PARK_PTR_REF	78	MM2S START ADDRESS8
2C	VDMA Version	7C	MM2S START ADDRESS9
30	S2MM_DMACR	80	MM2S START ADDRESS10
34	S2MM_DMASR	84	MM2S START ADDRESS11
38	S2MM_CURDESC	88	MM2S START ADDRESS12
3C	Reserved	8C	MM2S START ADDRESS13
40	S2MM_TAILDESC	90	MM2S START ADDRESS14
44	Reserved	94	MM2S START ADDRESS15
48	S2MM_FRMSTORE	98	MM2S START ADDRESS16
4C	S2MM_THRESHOLD	9C	Reserved
		A0	S2MM VSIZE
		A4	S2MM HSIZE
		A8	S2MM FRMDLY / STRIDE
		AC	S2MM START ADDRESS 1
		B0	S2MM START ADDRESS 2
		B4	S2MM START ADDRESS 3
		B8	S2MM START ADDRESS 4
		BC	S2MM START ADDRESS 5
		C0	S2MM START ADDRESS 6
		C4	S2MM START ADDRESS 7
		C8	S2MM START ADDRESS 8
		CC	S2MM START ADDRESS 9
		D0	S2MM START ADDRESS 10
		D4	S2MM START ADDRESS 11
		D8	S2MM START ADDRESS 12
		DC	S2MM START ADDRESS 13
		E0	S2MM START ADDRESS 14
		E4	S2MM START ADDRESS 15
		E8	S2MM START ADDRESS 16

2. Before integrating the VDMA Interface block in a System Generator design, it is highly recommended that you first familiarize yourself with the provided demos. In most cases, you should be able to utilize these demos as your initial template and customize them to fit in your specific application. The demos are listed as follows:
  - Double Buffer demo
  - Image Tile Reconstruction demo
  - Corner Turn for 2D FFT demo
  - Triple Buffer demo
  - Giant FIFO Using VDMA Interface demo
3. When debugging a VDMA Interface block, it is helpful to use either a small image or a simple input stimulus instead of a large image. This will help you reduce the design iteration time significantly.

4. Lastly, if you get stuck or if you have questions and/or Beta feedback, send email to the following address: [sysgen\\_vdma\\_feedback@xilinx.com](mailto:sysgen_vdma_feedback@xilinx.com)

## xlVDMACreateProject utility

The xlVDMACreateProject utility takes a System Generator design with an VDMA Interface block, and creates an ISE project with a top-level module that stitches the System Generator design with an XPS sub-module that instantiates the actual VDMA, AXI interconnect, and MIG IP.

### VDMA

The created ISE and XPS projects are initially set up for one of the following boards, based on the FPGA device chosen for the System Generator design:

- Xilinx ML605 for all Virtex-6 devices
- Xilinx SP601 for all Spartan-6 LX devices
- Xilinx SP605 for all Spartan-6 LXT devices
- Xilinx Kintex 7 for all Kintex devices.

Other device families are currently not supported.

To customize the ISE and XPS projects for a different board, do the following:

1. Open the generated ISE project in Project Navigator.
2. Double click the XPS sub-module to open the XPS GUI.
3. From the XPS GUI, customize the MIG and clock generator based on the DDR settings for the target board.
4. Close the XPS GUI and go back to Project Navigator.
5. Edit the generated top-level HDL if the DCM/MMCM settings do not match the target board.
6. Edit the generated top-level UCF if the constraints for the system clock do not match the target board.

### Usage:

```
xlVDMACreateProject (NetlistDirectory, TopLevelName, Options)
```

You should create the ISE and XPS projects for the System Generator design in the `NetlistDirectory` directory. If a `TopLevelName` is specified, the top-level module uses the given `TopLevelName` as entity name. Otherwise, the default entity name 'vdma\_top' is used.

Optional options can be specified through the `OPTIONS` argument, which is a MATLAB struct. The following options are supported:

**Debug:** If this value is true, ChipScope AXI monitors are inserted to various AXI interfaces in the design: `M_AXI_MM2S` and `M_AXI_S2MM` interfaces between the VDMA and AXI interconnect IP, and the `S_AXI` interface between the AXI interconnect and MIG IP.

## Block Parameters

### Basic tab

Parameters specific to the Basic tab are:

- **Memory size:** Specify the size of the external memory (16MB to 2GB).
- **Number of VDMA interfaces:** Specify the number of VDMA interfaces (1 to 4). If you specify 3, for example, the first three Interface tabs are activated and you can customize each interface separately. The fourth Interface tab is not activated.

### Interface 1-4 tab

Parameters specific to the Interface 1-4 tabs are:

#### Parameters

- **Stream interface:** Select Master/Slave, Master, or Slave.
- **Number of frame stores[1..16]:** Select the number of frame stores.
- **Use external frame sync:** Check to use an external frame sync. This adds a fsync input port to the block.
- **Use Scatter Gather Engine:**
- **Flush on frame sync:**
- **Use Video Parameter Read for Direct Mode:**

#### Master Stream Interface

##### Parameters

- **Data width:** Select the data width for the Master Stream Interface (8-256).

##### Video Line Buffer

- **Depth:** Select the depth for the Master Video Line Buffer (0-65535).
- **Almost empty threshold[1..65536]:** Select the threshold when the MM2S line buffer “almost\_empty” flag is asserted.

#### Slave Stream Interface

##### Parameters

- **Data width:** Select the data width for the Slave Stream Interface (8-256).

##### Video Line Buffer

- **Depth:** Select the depth for the Slave Video Line Buffer (0-65535).
- **Almost empty threshold[1..65536]:** Select the threshold when the MM2S line buffer “almost\_empty” flag is asserted.

Parameters used by this block are explained in the topic [Common Options in Block Parameter Dialog Boxes](#).

## LogiCORE™ Documentation

[LogiCORE IP AXI Video Direct Memory Access v4.00.a](#)

## Device Support

Virtex-7, Kintex-7, Virtex-6, Spartan-6



## VDMA Interface 5.4

This block is listed in the following Xilinx Blockset libraries: AXI4, Index and Memory.

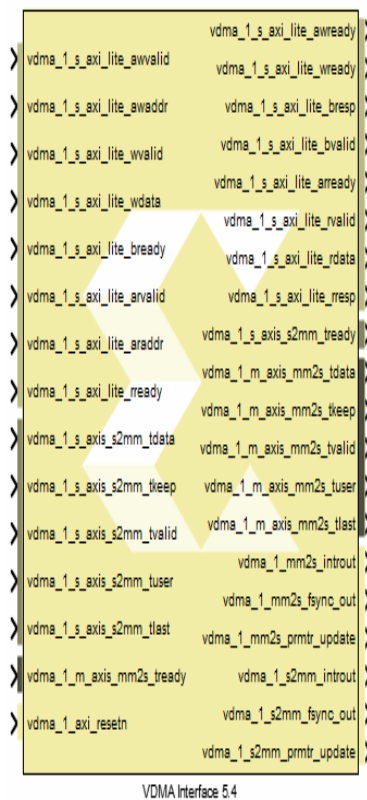

The VDMA (Video Direct Memory Access) Interface block is a bit-accurate simulation model containing up to 4 AXI VDMA IP LogiCOREs connected to an AXI interconnect and external memory.

As shown in the illustration below, the VDMA Interface block's AXI memory-mapped interface is connected to the AXI Interconnect. DDR external memory is connected as the only slave on the AXI Interconnect. All ports except memory-mapped ports of the VDMA block are available on the VDMA Interface block.

This block is also supported by the Hardware Co-Simulation flow. The supported boards are SP601, SP605 and ML605 and Kintex 7.

The block can now be configured using 'Scatter Gather Engine' mode as well as 'Direct Register' mode.

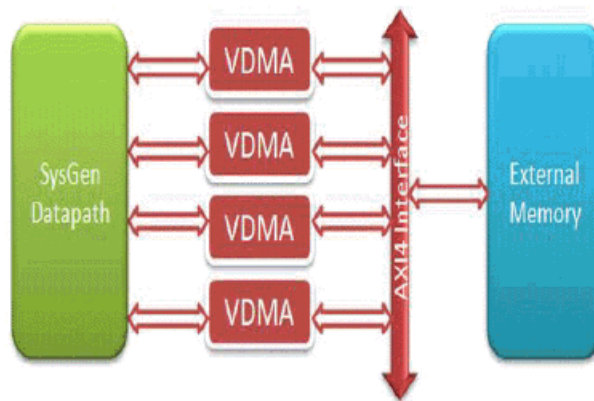

The VDMA Interface block is a simulation-only model and when the netlist is generated, only the block interface is netlisted as top-level gateways. A [xlVDMACreateProject utility](#) is provided that takes a design with a VDMA Interface block and creates an ISE project with a top-level module that stitches the System Generator design with an XPS sub-module that instantiates the actual VDMA, AXI interconnect, and MIG IP.

**Note:** In the simulation model, the memory contents are initialized to 0, however, the memory in the actual hardware might not be initialized to 0 unless you add hardware that does the initialization.

### Preparing to Use This Block

1. Please read the AXI Video Direct Memory Access (axi\_vdma) Product Guide to become familiar with the behavior of the LogiCORE before using this block.

[LogiCORE IP AXI Video Direct Memory Access v5.04a](#)

### xlVDMACreateProject utility

The xlVDMACreateProject utility takes a System Generator design with an VDMA Interface block, and creates an ISE project with a top-level module that stitches the System Generator design with an

XPS sub-module that instantiates the actual VDMA, AXI interconnect, and MIG IP.

## VDMA

The created ISE and XPS projects are initially set up for one of the following boards, based on the FPGA device chosen for the System Generator design:

- Xilinx ML605 for all Virtex-6 devices
- Xilinx SP601 for all Spartan-6 LX devices
- Xilinx SP605 for all Spartan-6 LXT devices
- Xilinx Kintex 7 for all Kintex devices.

Other device families are currently not supported.

To customize the ISE and XPS projects for a different board, do the following:

1. Open the generated ISE project in Project Navigator.
2. Double click the XPS sub-module to open the XPS GUI.
3. From the XPS GUI, customize the MIG and clock generator based on the DDR settings for the target board.
4. Close the XPS GUI and go back to Project Navigator.
5. Edit the generated top-level HDL if the DCM/MMCM settings do not match the target board.
6. Edit the generated top-level UCF if the constraints for the system clock do not match the target board.

## Usage:

```
xlVDMACreateProject (NetlistDirectory, TopLevelName, Options)
```

You should create the ISE and XPS projects for the System Generator design in the `NetlistDirectory` directory. If a `TopLevelName` is specified, the top-level module uses the given `TopLevelName` as entity name. Otherwise, the default entity name 'vdma\_top' is used.

Optional options can be specified through the `OPTIONS` argument, which is a MATLAB struct. The following options are supported:

**Debug:** If this value is true, ChipScope AXI monitors are inserted to various AXI interfaces in the design: `M_AXI_MM2S` and `M_AXI_S2MM` interfaces between the VDMA and AXI interconnect IP, and the `S_AXI` interface between the AXI interconnect and MIG IP.

## Block Parameters

### Basic tab

Parameters specific to the Basic tab are:

- **Memory size:** Specify the size of the external memory (16MB to 2GB).
- **Number of VDMA interfaces:** Specify the number of VDMA interfaces (1 to 4). If you specify 3, for example, the first three Interface tabs are activated and you can customize each interface separately. The fourth Interface tab is not activated.

### Interface 1-4 tab

Parameters specific to the Interface 1-4 tabs are:

Parameters

- **Stream interface:** Select Master/Slave, Master, or Slave.
- **Number of frame stores[1..32]:** Select the number of frame stores. Increased from 16 to 32 over the 4.0 VDMA Interface block.
- **Use external frame sync:** Check to use an external frame sync. This adds a fsync input port to the block.
- **Use Scatter Gather Engine:**
- **Flush on frame sync:**
- **Use Video Parameter Read for Direct Mode:**

Master Stream Interface

Parameters

- **Data width:** Select the data width for the Master Stream Interface (8-256).
- **Frame sync on TUSER(0):** Activated when **Use external frame sync** is selected. New optional TUSER bus added to MM2S and S2MM AXIS interfaces with TUSER (0) being used for a Start of Frame (SOF) or external frame sync. When enabled (C\_MM2S\_SOF\_ENABLE=1), the MM2S channel will drive frame sync out on m\_axis\_mm2s\_tuser (0). When enable (C\_S2MM\_SOF\_ENABLE=1), the S2MM channel will sync to frame sync in on s\_axis\_s2mm\_tuser (0). This adds 4 new parameters to set the width of the TUSER buses, C\_MM2S\_SOF\_ENABLE, C\_S2MM\_SOF\_ENABLE, C\_M\_AXIS\_MM2S\_TUSER\_BITS, and C\_S\_AXIS\_S2MM\_TUSER\_BITS.

Video Line Buffer

- **Depth:** Select the depth for the Master Video Line Buffer (0-65535).
- **Almost empty threshold[1..65536]:** Select the threshold when the MM2S line buffer “almost\_empty” flag is asserted.

Slave Stream Interface

Parameters

- **Data width:** Select the data width for the Slave Stream Interface (8-256).

Video Line Buffer

- **Depth:** Select the depth for the Slave Video Line Buffer (0-65535).
- **Almost empty threshold[1..65536]:** Select the threshold when the MM2S line buffer “almost\_empty” flag is asserted.

Parameters used by this block are explained in the topic [Common Options in Block Parameter Dialog Boxes](#).

## LogiCORE™ Documentation

[LogiCORE IP AXI Video Direct Memory Access v5.04a](#)

## Device Support

Zynq-7000, Virtex-7, Kintex-7, Artix-7, Virtex-6, Spartan-6

# Viterbi Decoder 7.0

This block is listed in the following Xilinx Blockset libraries: *Communications and Index*.



Data encoded with a convolution encoder can be decoded using the Xilinx Viterbi decoder block.

There are two steps to the decode process. The first weighs the cost of incoming data against all possible data input combinations; either a Hamming or Euclidean metric can be used to determine the cost. The second step traces back through the trellis and determines the optimal path. The length of the trace through the trellis can be controlled by the traceback length parameter.

The decoder achieves minimal error rates when using optimal convolution codes; the table below shows various optimal codes. For correct operation, convolution codes used for encoding must match with that for decoding.

Constraint length	Optimal convolution codes for 1/2 rate (octal)	Optimal convolution codes for 1/3 rate (octal)
3	[7 5]	[7 7 5]
4	[17 13]	[17 13 15]
5	[37 33]	[37 33 25]
6	57 65]	[57 65 71]
7	[117 127]	[117 127 155]
8	[357 233]	[357 233 251]
9	[755 633]	[755 633 447]

## Block Interface



The Viterbi decoder supports rates from 1/2 to 1/7 and consequently displays two to seven input ports labeled din1 through din7. Hard coding requires each data input to be 1 bit wide. Soft coding allows widths to be between 3 to 8 bits (inclusive). The vin port indicates that the values presented on the din ports are valid. When using external puncturing, depending on the decoder rate, up to seven erase ports become available. If an erase pin is high, the corresponding data pins are treated as a null-symbol. For a given constraint length and traceback length, the block can function as a dual decoder, for example, two convolution codes and two output rates. An input port labeled sel indicates the convolution code to which the input data corresponds, when sel is 0 (respectively, 1) the data is decoded using convolution code array 1 (respectively, 2).

The Viterbi Decoder can have two to five output ports. The dout port outputs the 1 bit decoded result and vout indicates that the value is valid. The ber port gives a measurement of the bit error rate of the channel by counting the differences between the re-encoded dout and the delayed din values. The number of errors detected is divided by 8 and output on the ber port. The ber\_done port indicates when the number of input samples for error count (as indicated on the mask) have been processed. The norm signal indicates when normalization has occurred within the block. The norm port gives immediate monitoring of errors on the channel. The more frequent the normalization (for example, the norm port going high), the higher the rate of errors present.

## Block Parameters

### Page1 tab

Parameters specific to the Page1 tab are:

Viterbi Type

- **Standard:** This type is the basic Viterbi Decoder.
- **Multi-Channel:** This type allows many interlaced channels of data to be decoded using a single Viterbi Decoder.
- **Number of Channels:** Used with the Muli-Channel selection, the number of channels to be decoded can be any value between 2 and 32.
- **Trellis Mode:** This type is a trellis mode decoder using the TCM and SECTOR\_IN inputs.
- **Dual Decoder:** When selected, the block behaves as a dual decoder with two sets of convolutional codes. This makes the sel input port available.

Decoder Options

- **Use Reduced Latency:** The latency of the block depends on the traceback length and the constraint length. If this reduced latency option is selected, then the latency of the block is approximately halved and the latency is only 2 times the traceback length.
- **Constraint length:** Equals  $n+1$ , where  $n$  is the length of the constraint register in the encoder.
- **Traceback length:** Length of the traceback through the Viterbi trellis. Optimal length is 5 to 7 times the constraint length.

Page2 tab

Architecture

- **Parallel:** Large but fast Viterbi Decoder
- **Serial:** Small but processes the input data in a serial fashion. The number of clock cycles needed to process each set of input symbols depends on the output rate and the soft width of the data.

#### Best State

- **Use Best State:** Gives improved BER performance for highly punctured data.
- **Best State Width:** Indicates how many of the least significant bits to ignore when saving the cost used to determine the best state.

#### Coding

- **Soft Width:** The input width of soft-coded data can be anything in the range 3 to 8. Larger widths require more logic. If the block is implemented in serial mode, larger soft widths also increase the serial processing time.
- **Soft Coding:** Uses the Euclidean metric to cost the incoming data against the branches of the Viterbi trellis.
- **Hard Coding:** Uses the Hamming difference between the input data bits and the branches of the Viterbi trellis. Hard coding is only available for the standard parallel block.

#### Data Format

- **Signed magnitude:**
- **Offset Binary** (available for soft coding only):  
See Table 1 in the associated LogiCORE Product Specification for the Signed Magnitude and Offset-Binary data format for Soft Width 3.

## Dual Rate Decoder

For a given constraint length and traceback-length, the block can function as a dual decoder. Two sets of convolutional codes and output rates can be used internally to the decoder. The dual-decoder offers significant chip area savings when two different decoders with the same constraint length are required. The next two tabs allow you to specify the convolution codes for the dual decoder capability.

### Page3 tab

#### Convolution 0

- **Output Rate 0:** Output Rate 0 can be any value from 2 to 7.
- **Convolution Code 0 Radix:** The convolutional codes can be input and viewed in binary, octal, or decimal.
- **Convolution Code Array (0-6):** First array of convolution codes. Output rate is derived from the array length. Between 2 and 7 (inclusive) codes can be entered. When dual decoding is used, a value of 0 (low) on the sel port corresponds to this array.

### Page4 tab

The options on this tab are activated when you select **Dual Decoder** as the Viterbi Type on the Page1 tab.

#### Convolution 1

- **Output Rate 1:** Output Rate 1 can be any value from 2 to 7. This is the second output rate used if the decoder is dual. The incoming data is decoded at this rate when the SEL input is high. Output Rate 1 is not used for the non-dual decoder.
- **Convolution Code 1 Radix:** The convolutional codes can be input and viewed in binary, octal, or decimal.

- **Convolution Code Array (0-6):** First array of convolution codes. Output rate is derived from the array length. Between 2 and 7 (inclusive) codes can be entered. When dual decoding is used, a value of 1 (high) on the sel port corresponds to this array.

## Page5 tab

### Packet Options

#### Trellis Initialization

- **None:** There is no initialization on the trellis.
- **State Zero:** The trellis is initialized to state zero when the PACKET\_START signal is asserted (High). The costs of the states are all initialized in the ACS module to a maximum value except for state zero.
- **Equal States:** All the states within the trellis are initialized to the same value when the PACKET\_START signal is asserted (High).
- **User Input:** The trellis is initialized to the state on PS\_STATE when the PACKET\_START signal is asserted (High). The costs of the states are all initialized in the ACS module to a maximum value except for the dynamically input state, which is initialized to zero when the PACKET\_START input is High.

#### Direct Traceback

The direct traceback allows you to specify the handling of the traceback and the end state of the packet.

- **Maximum Direct:** Specifies the number of encoded bits to be traced directly. The range is 10 to 42.
- **None:** There is no direct traceback.
- **State Zero:** When the TB\_BLOCK signal is asserted (High), the input data is traced back directly without a training sequence from state zero.
- **User Input:** When the TB\_BLOCK signal is asserted (High), the input data is traced back directly without a training sequence from the user input TB\_STATE. The value of the TB\_STATE is selected on the last clock edge of the TB\_BLOCK signal High.
- **Best State:** When the TB\_BLOCK signal is asserted (High), the input data is traced back directly without a training sequence from the best state. The best state is generated internally to the decoder from the costs on the ACS modules.

## Page6 tab

### Puncturing

- **None:** Input data has not been punctured.
- **External (Erased Symbols):** When selected an erase port is added to the block. The presence of null-symbols (that is, symbols which have been deleted prior to transmission across the channel) is indicated using the erasure input erase.

### BER Options

- **Use BER Symbol Count:** This bit-error-rate (BER) option monitors the error rate on the transmission channel.
- **Number of BER Symbols:** Specifies the number of input symbols over which the error count takes place.



## Page7 tab

## Synchronization Options

- **Use Synchronization:** Check this box if an out of synchronization output is required.
- **Use Dynamic Thresholds:** If this check box is selected, then the synchronization inputs buses NORM\_THRESH and BER\_THRESH are added to the block. These 16-bit input buses correspond to the BER thresh and Norm thresh, but allow the thresholds for synchronization evaluation to be dynamically modified.

## Static Thresholds

- **BER Thresh:** This is the preset threshold for synchronization evaluation. If the bit error count reaches this threshold before the normalization threshold is obtained, then the block is considered to be out of synchronization and the OUT\_OF\_SYNC output is asserted.
- **Norm Thresh:** This is the preset threshold for synchronization evaluation. If the normalization count reaches this threshold before the bit error threshold is obtained, then the block is considered to be synchronized and the OUT\_OF\_SYNC output is deasserted.

## Page8 tab

## Optional Pins

- **CE:** Clock Enable – Core clock enable (active High). When this signal is active, the decoder processes input data normally. When this signal is inactive, the decoder stops processing data and maintains its state.
- **RDY:** Indicates valid data on output port DATA\_OUT. This output is mandatory in the serial case
- **SCLR:** Synchronous Clear – Synchronous reset (active High). Asserting SCLR synchronously with CLK resets the decoder internal state.
- **NORM:** Indicates when normalization has taken place internal to the Add Compare Select module
- **Block Valid:** Check this box if BLOCK\_IN and BLOCK\_OUT signals are required. These signals track the movement of a block of data through the decoder. BLOCK\_OUT corresponds to BLOCK\_IN delayed by the decoder latency.

Parameters used by this block are explained in the topic [Common Options in Block Parameter Dialog Boxes](#).

## LogiCORE™ Documentation

[LogiCORE IP Viterbi Decoder v7.0](#)

### Device Support

Virtex-7 and Kintex-7, Virtex-6, Virtex-5, Virtex-4,  
Spartan-6, Spartan-3/XA, Spartan-3E/XA, Spartan-3A/3AN/3A DSP/XA

# Viterbi Decoder 8.0

This block is listed in the following Xilinx Blockset libraries: AXI4, Communications and Index.

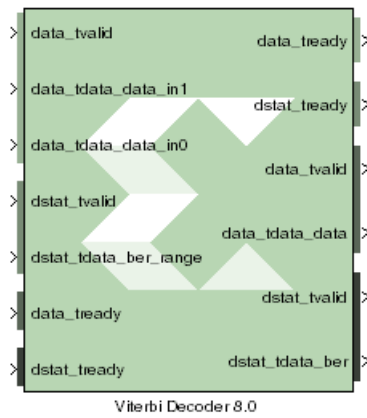

Data encoded with a convolution encoder can be decoded using the Xilinx Viterbi decoder block. This block adheres to the AMBA® AXI4-Stream standard.

There are two steps to the decode process. The first weighs the cost of incoming data against all possible data input combinations; either a Hamming or Euclidean metric can be used to determine the cost. The second step traces back through the trellis and determines the optimal path. The length of the trace through the trellis can be controlled by the traceback length parameter.

The decoder achieves minimal error rates when using optimal convolution codes; the table below shows various optimal codes. For correct operation, convolution codes used for

encoding must match with that for decoding.

Constraint length	Optimal convolution codes for 1/2 rate (octal)	Optimal convolution codes for 1/3 rate (octal)
3	[7 5]	[7 7 5]
4	[17 13]	[17 13 15]
5	[37 33]	[37 33 25]
6	57 65]	[57 65 71]
7	[117 127]	[117 127 155]
8	[357 233]	[357 233 251]
9	[755 633]	[755 633 447]

## Block Interface

The Xilinx Viterbi Decoder 8.0 block is AXI4 compliant. The following describes the standard AXI channels and pins on the interface:

### S\_AXIS\_DATA Channel

- **s\_axis\_data\_tvalid:** TVALID for S\_AXIS\_DATA channel. Input pin, always available. This port indicates the values presents on the inputdata ports are valid.
- **s\_axis\_data\_tready:** TREADY for S\_AXIS\_DATA. Output pin, always available. This port indicates that the core is ready to accept data.
- **s\_axis\_data\_tdata:** Input TDATA. Different input data ports are available depending on the Viterbi Type selected on Page1 tab of block-GUI.

When Trellis Mode is selected, 5 input data pins become available – these are **s\_axis\_data\_tdata\_tcm00**, **s\_axis\_data\_tdata\_tcm01**, **s\_axis\_data\_tdata\_tcm10**, **s\_axis\_data\_tdata\_tcm11** and **s\_axis\_data\_tdata\_sector**.

The width of the Trellis mode inputs (`s_axis_data_tdata_tcm**`) can range from 4 to 6 corresponding to a data width (Soft\_Width value on Page2 tab) of 3 to 5. `s_axis_data_tdata_sector` is always 4-bit wide. The decoder always functions as a rate 1/2 decoder when Trellis mode is selected.

For any other Viterbi Type (Standard/Multi-Channel/Dual Decoder), the Decoder supports rates from 1/2 to 1/7. Therefore, the block can have 2 to 7 input data ports labeled `s_axis_data_tdata_data_in0 ... s_axis_data_tdata_data_in6`. Hard Coding requires each `data_in<n>` port to be 1 bit wide. Soft Coding allows these widths to be between 3 to 5 bits (inclusive).

- s\_axis\_data\_tuser**: TUSER for S\_AXIS\_DATA. These ports are only present if External Puncturing is selected or it is a Dual Decoder or Block Valid signal is used with the core.
  - s\_axis\_data\_tuser\_erase** port becomes available, when External Puncturing is selected (on Page2 tab). This input bus is used to indicate the presence of a null-symbol on the corresponding `data_in` buses. For e.g. `tuser_erase(0)` corresponds to `data_in0`, `tuser_erase(1)` corresponds to `data_in1` etc.. If an erase bit is high, the data on the corresponding `data_in` bus is treated as a null-symbol internally to the decoder. The width of the erase bus is equal to the output rate of the decoder with a maximum value of 7.
  - s\_axis\_data\_tuser\_sel** port becomes available when Dual Decoder is selected. This is used to select the correct set of convolution codes for the decoding of the input data symbols in the dual decoder case. When SEL is low, the input data is decoded using the first set of convolution codes. When it is high, the second set of convolution codes is applied.
  - s\_axis\_data\_tuser\_block\_in** port becomes available when Block Valid option is selected on Page 5 tab.

## M\_AXIS\_DATA Channel

- m\_axis\_data\_tvalid**: TVALID for M\_AXIS\_DATA channel. Output pin, always available. It indicates whether the output data is valid or not.
- m\_axis\_data\_tready**: TREADY for M\_AXIS\_DATA channel. Do not enable or tie high if downstream slave is always able to accept data. It becomes available when TREADY option is selected on Page 5 tab.
- m\_axis\_data\_tdata**: decoded TDATA for output data channel.
  - m\_axis\_data\_tdata\_data** port represents the decoded output data and it is always 1 bit wide.
  - m\_axis\_data\_tdata\_sector** port becomes available for Trellis Mode decoder. This port is always 4-bit wide. The output SECTOR is a delayed version of the input SECTOR bus. Both buses have a fixed width of 4 bits. The delay equals the delay through the Trellis Mode decoder.
- m\_axis\_data\_tuser**: TUSER for M\_AXIS\_DATA channel. These ports are only present if the block is a Dual Decoder or it has normalization signal present or it has Block Valid option checked.
  - m\_axis\_data\_tuser\_sel** port becomes available when the block is configured as a Dual Decoder. This signal is a delayed version of the input `s_axis_data_tuser_sel` signal. The delay equals to the delay through the Dual Decoder.
  - m\_axis\_data\_tuser\_norm** port becomes available when NORM option is checked on Page 5 tab. This port indicates when normalization has occurred within the core. It gives an immediate indication of the rate of errors in the channel.
  - m\_axis\_data\_tuser\_block\_out** port becomes available when Block Valid option is checked on Page 5 tab. This signal is a delayed version of the input `s_axis_data_tuser_block_in` signal. The BLOCK\_OUT signal shows the decoded data corresponding to the original BLOCK\_IN set of

data points. The delay equals the delay through the decoder.

### S\_AXIS\_DSTAT Channel

**Note:** These ports become available when Use BER Symbol Count is selected on Page 5 tab.

- **s\_axis\_dstat\_tvalid:** TVALID for S\_AXIS\_DSTAT channel.
- **s\_axis\_dstat\_tready:** TREADY for S\_AXIS\_DSTAT channel. Indicates that the core is ready to accept data. Always high, except after a reset if there is not a TREADY on the output.
- **s\_axis\_dstat\_tdata\_ber\_range:** TDATA for S\_AXIS\_DSTAT channel. This is the number of symbols over which errors are counted in the BER block.

### M\_AXIS\_DSTAT Channel

**Note:** These ports become available when Use BER Symbol Count is selected on Page 5 tab.

- **m\_axis\_dstat\_tvalid:** TVALID for M\_AXIS\_DSTAT channel.
- **m\_axis\_dstat\_tready:** TREADY for M\_AXIS\_DSTAT channel. Do not enable or tie high if downstream slave is always able to accept data. It becomes available when TREADY option is selected on Page 5 tab.
- **m\_axis\_dstat\_tdata\_ber:** TDATA for M\_AXIS\_DSTAT channel. The Bit Error Rate (BER) bus output (fixed width 16) gives a measurement of the channel bit error rate by counting the difference between the re-encoded DATA\_OUT and the delayed DATA\_IN to the decoder.

### Other Optional Pins

- **aresetn:** The synchronous reset (aresetn) input can be used to re-initialize the core at any time, regardless of the state of aclken signal. aresetn needs to be asserted low for at least two clock cycles to initialize the circuit. This pin becomes available if ARESETN option is selected on the Page 5 tab. It must be of type Bool. If this pin is not selected, System Generator ties this pin to inactive (high) on the core.
- **aclken:** Carries the clock enable signal for the decoder. The signal driving aclken must be Bool. This pin becomes available if ACLKEN option is selected on Page 5 tab.

## Block Parameters

### Page1 tab

Parameters specific to the Page1 tab are:

Viterbi Type

- **Number of Channels:** Used with the Multi-Channel selection, the number of channels to be decoded can be any value between 2 and 32.
- **Standard:** This type is the basic Viterbi Decoder.
- **Multi-Channel:** This type allows many interlaced channels of data to be decoded using a single Viterbi Decoder.
- **Trellis Mode:** This type is a trellis mode decoder using the TCM and SECTOR\_IN inputs.
- **Dual Decoder:** When selected, the block behaves as a dual decoder with two sets of convolutional codes. This makes the sel input port available.

Decoder Options

- **Use Reduced Latency:** The latency of the block depends on the traceback length and the constraint length. If this reduced latency option is selected, then the latency of the block is approximately halved and the latency is only 2 times the traceback length.
- **Constraint length:** Equals  $n+1$ , where  $n$  is the length of the constraint register in the encoder.
- **Traceback length:** Length of the traceback through the Viterbi trellis. Optimal length is 5 to 7 times the constraint length.

Page2 tab

Architecture

- **Parallel:** Large but fast Viterbi Decoder
- **Serial:** Small but processes the input data in a serial fashion. The number of clock cycles needed to process each set of input symbols depends on the output rate and the soft width of the data.

#### Best State

- **Use Best State:** Gives improved BER performance for highly punctured data.
- **Best State Width:** Indicates how many of the least significant bits to ignore when saving the cost used to determine the best state.

#### Puncturing

- **None:** Input data has not been punctured.
- **External (Erased Symbols):** When selected an erase port is added to the block. The presence of null-symbols (that is, symbols which have been deleted prior to transmission across the channel) is indicated using the erasure input erase.

#### Coding

- **Soft Width:** The input width of soft-coded data can be anything in the range 3 to 5. Larger widths require more logic. If the block is implemented in serial mode, larger soft widths also increase the serial processing time.
- **Soft Coding:** Uses the Euclidean metric to cost the incoming data against the branches of the Viterbi trellis.
- **Hard Coding:** Uses the Hamming difference between the input data bits and the branches of the Viterbi trellis. Hard coding is only available for the standard parallel block.

#### Data Format

- **Signed Magnitude:**
- **Offset Binary** (available for soft coding only):  
See Table 1 in the associated LogiCORE Product Specification for the Signed Magnitude and Offset-Binary data format for Soft Width 3.

### Page3 tab

#### Convolution 0

- **Output Rate 0:** Output Rate 0 can be any value from 2 to 7.
- **Convolution Code 0 Radix:** The convolutional codes can be input and viewed in binary, octal, or decimal.
- **Convolution Code Array (0-6):** First array of convolution codes. Output rate is derived from the array length. Between 2 and 7 (inclusive) codes can be entered. When dual decoding is used, a value of 0 (low) on the sel port corresponds to this array.

### Page4 tab

The options on this tab are activated when you select **Dual Decoder** as the Viterbi Type on the Page1 tab.

#### Convolution 1

- **Output Rate 1:** Output Rate 1 can be any value from 2 to 7. This is the second output rate used if the decoder is dual. The incoming data is decoded at this rate when the SEL input is high. Output Rate 1 is not used for the non-dual decoder.
- **Convolution Code 1 Radix:** The convolutional codes can be input and viewed in binary, octal, or decimal.
- **Convolution Code Array (0-6):** First array of convolution codes. Output rate is derived from the array length. Between 2 and 7 (inclusive) codes can be entered. When dual decoding is used, a value of 1 (high) on the sel port corresponds to this array.

## Page5 tab

## BER Options

- **Use BER Symbol Count:** This bit-error-rate (BER) option monitors the error rate on the transmission channel.

## Optional Pins

- **NORM:** Indicates when normalization has taken place internal to the Add Compare Select module
- **Block Valid:** Check this box if BLOCK\_IN and BLOCK\_OUT signals are required. These signals track the movement of a block of data through the decoder. BLOCK\_OUT corresponds to BLOCK\_IN delayed by the decoder latency.
- **TREADY:** Selecting this option makes m\_axis\_data\_tready and m\_axis\_dstat\_tready pins available on the block.
- **ACLKEN:** carries the clock enable signal for the block The signal driving acken must be Bool.
- **ARESETN:** Adds a **aresetn** pin to the block. This signal resets the block and must be of type Bool. **aresetn** must be asserted low for at least 2 clock periods and at least 1 sample period before the decoder can start decoding code symbols.

Common Parameters used by this block, such as **Display shortened port names**, are explained in the topic [Common Options in Block Parameter Dialog Boxes](#).



## LogiCORE™ Documentation

[LogiCORE IP Viterbi Decoder v8.0](#)

## Device Support

Zynq-7000, Artix-7, Virtex -7, Kintex-7, Virtex-6, Spartan -6

## WaveScope

This block is listed in the following Xilinx Blockset libraries: *Floating-Point, Tools and Index*.

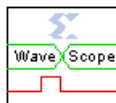



The System Generator WaveScope block provides a powerful and easy-to-use waveform viewer for analyzing and debugging System Generator designs.

The viewer allows you to observe the time-changing values of any wires in the design after the conclusion of the simulation. The signals can be formatted in a logic or analog format and can be viewed in binary, hex, or decimal radices.

### Quick Tutorial

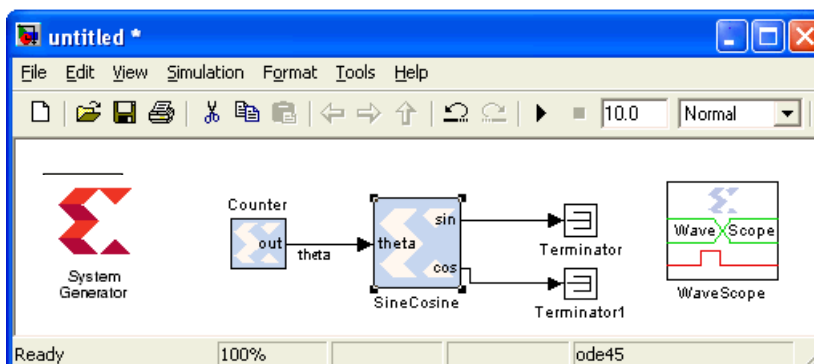
The following is a simple example to show how to use the WaveScope with this simple model:



Note that the WaveScope block has been dropped into the model. You double-click on the WaveScope block to open it, which brings up the blank waveform viewer. Now you can highlight the three wires in the model by clicking on all three wires while holding down the **Shift** key. you then push the **Add Selected Nets**  button in the waveform viewer to add those wires to the viewer. The WaveScope window now appears as shown:

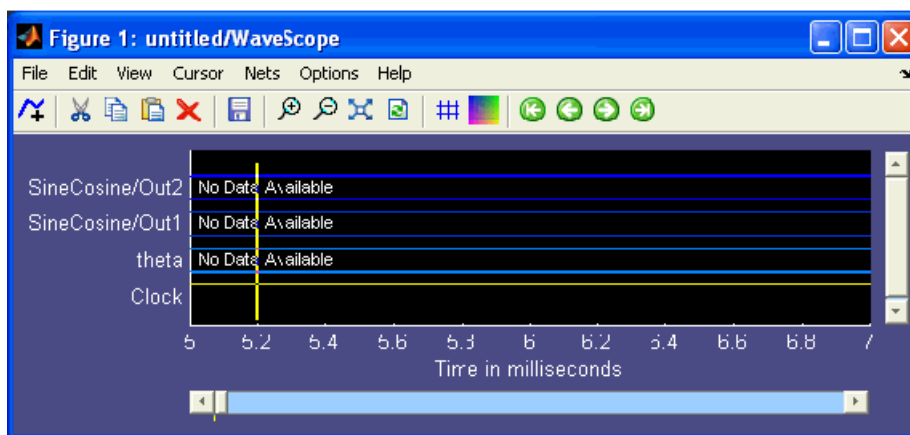

The three signals appear in the viewer. Two of the signals have been automatically named because they were not explicitly named in the model. Now you run the simulation using the **Start**  button on the model's window. This simulation has a period of 1s and runs for 10s. The waveform viewer

automatically updates. You can zoom out to the full view using the  button and the viewer appears as shown:

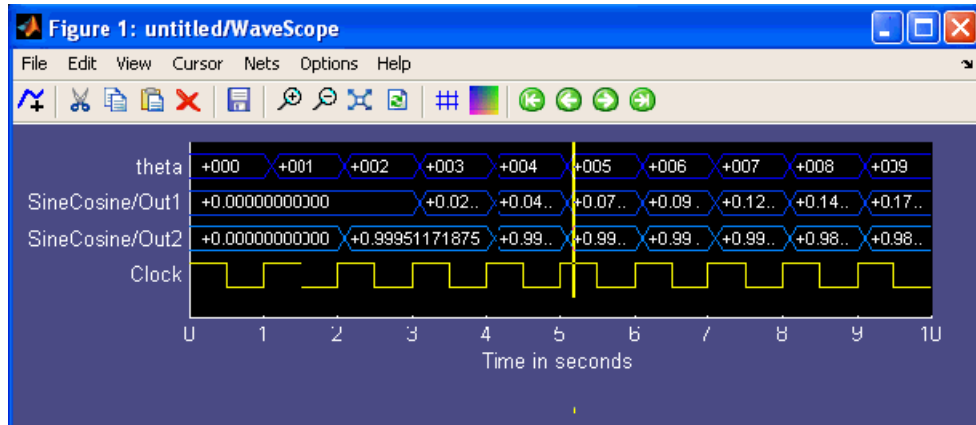

You can change the radix of the signal 'theta' to hex. You click on the name 'theta' or the associated signal waveform to highlight it, then double-click on the highlighted signal (not on the name) to bring up the formatting menu:

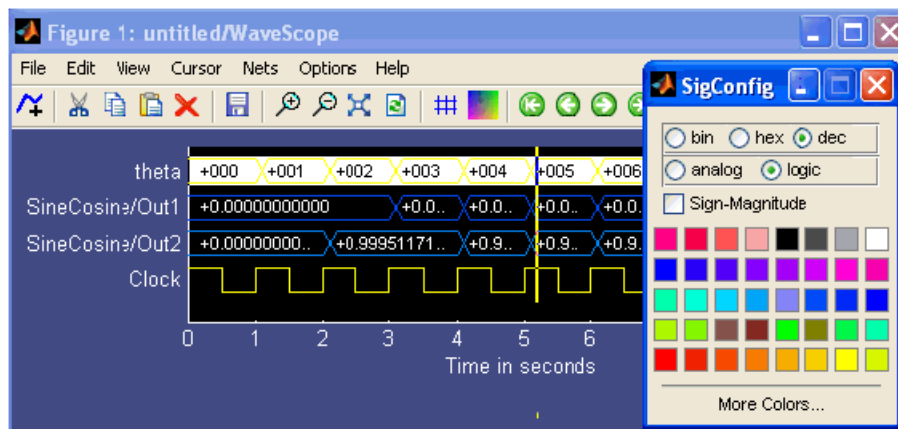

You select the **hex** radio button to format 'theta' as **binary**. In a similar fashion, you can format the signal 'SineCosine/Out1' as **analog** and change the color to **red**:

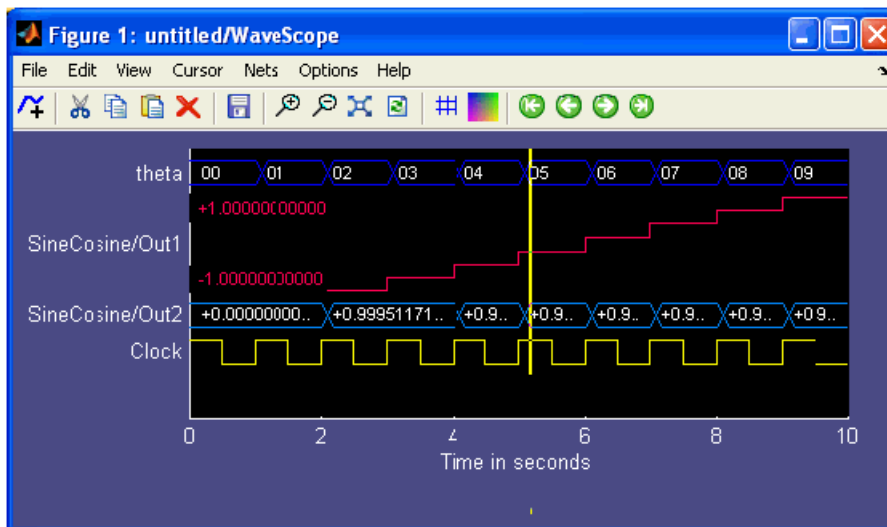

You can now change the names of the signals by double-clicking on the signal names and entering new names in the text box:

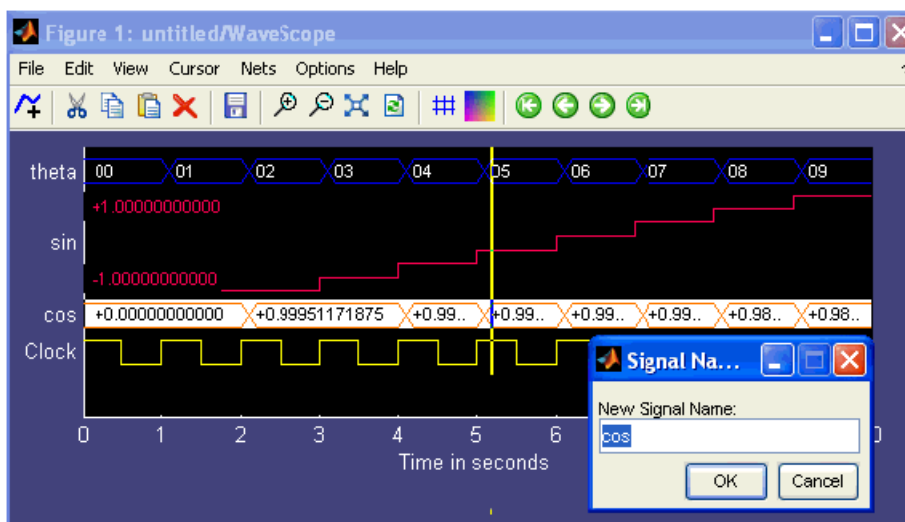

The new signal names are displayed in the model. By using the  button, you can zoom in on a portion of the simulation. You can bring the yellow cursor to the center of the screen using the

**Cursor > Center Cursor** menu option and observe the value for any signal under the cursor by placing the mouse pointer on the cursor:

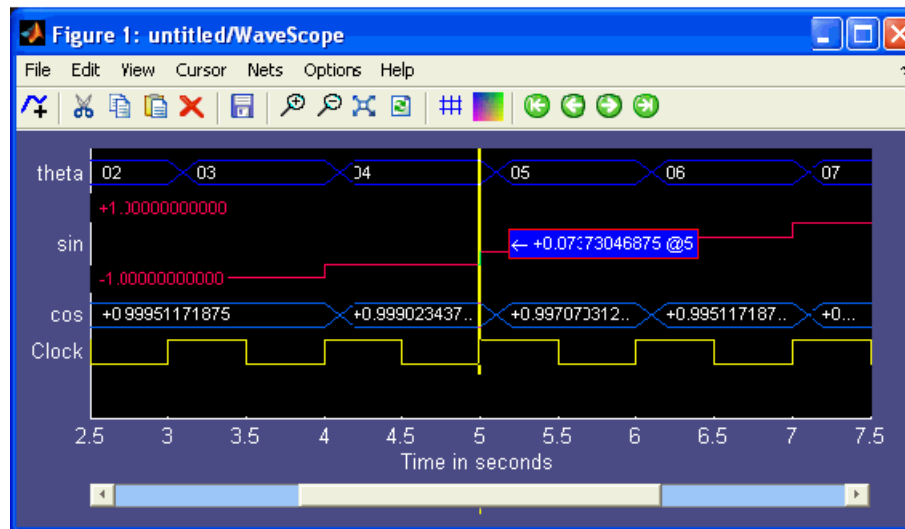

## Block Interface

Double-clicking the WaveScope icon opens up the WaveScope window. If the WaveScope window is closed, it will open automatically at the end of a simulation. The WaveScope window is a powerful "scope" in which the simulation results can be displayed in several ways.

WaveScope displays the signal on a given net or nets. The signal can be viewed in more than one way simultaneously, for example, viewing it both in logical and analog formats. Each signal can be displayed either as logic or analog, and the values can be displayed in hexadecimal, binary, or decimal radices. At the bottom of the display is the clock signal for reference.

The WaveScope window can be used to

- Choose which nets' signals to view
- Configure the signals' presentation
- View the signals

## Selecting Nets

There are two ways to select nets to view in the WaveScope window. Select any output net(s) of a Xilinx block (or the blocks themselves) in the Simulink window, then press the  icon in the WaveScope toolbar ("Add selected nets"). Multiple blocks/nets can be selected by holding the 'shift' key while selecting. The signal for the selected net(s) will appear in the WaveScope window. For any blocks that were selected, all of the inputs and outputs to the selected blocks are added to the WaveScope window. There is no data for the WaveScope to display until the model is simulated. After simulation, the data will appear in the WaveScope window.

Pressing the **Add Selected Nets** button in the tool bar multiple times will display the signal in the WaveScope viewer multiple times.

The second method of choosing nets is to use the "Nets" menu. This contains a hierarchical list of blocks and nets in your model. In a complex diagram it might be easier to use this menu to navigate to a particular net.

At the bottom of the display you will see a clock signal representing the highest rate clock in the design. This signal is always displayed whenever any signal is displayed.

## Selecting and Moving Signals

Click on a signal or the corresponding net name with the left mouse button to select the signal. Once a signal has been selected it can be moved in the display by dragging it to a different location. If you wish to select several signals at once, use Shift-click or Control-click on the *net names* only; it will not work with the signals themselves.

If you select multiple signals, which need not be contiguous signals in the display, and move them in the display, they will all be moved to a contiguous block of signals. This is handy for displaying several related signals together so they can all be seen at once.

You cannot select or move the clock signal in the WaveScope display. The clock signal will always be the last signal displayed.

## Deleting Signals from the WaveScope Window

If you decide not to view a signal after adding it to the WaveScope window, just select the signal and press the **Delete Signals** button on the toolbar. The del key is the keyboard shortcut to this function, and the Edit menu provides a "Delete" item as well.

The standard **Cut**, **Copy** and **Paste** functions are available for signals as well. Using the Copy and Paste icons on the toolbar, keyboard shortcuts **Control-X** for cut, **Control-C** for copy and **Control-V** for paste, or the **Copy** and **Paste** entries in the **Edit** menu, allows you to display a net multiple times in the WaveScope.

You cannot copy, paste, or delete the clock signal from the WaveScope display.

## Configuring the Signals' Presentation

Some signals are naturally viewed as numerical values in which the value is of primary concern, and some as logical states in which the transition is the key datum. With WaveScope you can choose which way to view the signal.

Select the signal(s) in question, then double-click on the signal. (Double-click on the signal itself, not on the signal's name.) A menu will appear with four choices:

- **Format** – Select "logic" to show the signal as a logical signal with transitions emphasized. The value is written after each transition. Select "analog" to display the signal as a graph of the value. The high and low values for the signal are display in the left of the graph as well. The size of the analog signal can be changed by dragging the bottom of the selected analog signal.
- **Radix** – Select "hex," "binary" or "dec" to choose the radix of the displayed numbers. Numbers will always be displayed with the proper radix point. For example, the decimal number 10.5 would be displayed as A.8 in hex.
- **Sign-Magnitude** - Select "Sign-Magnitude" to have WaveScope interpret the values as a sign-magnitude rather than a two's complement number. Decimal values are always displayed in sign-magnitude format.
- **Color** – Wavescope chooses a default value for a color. Use a colored button to select a new color for all the selected signals.

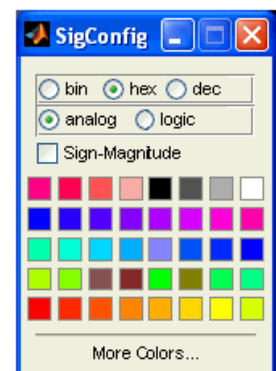

A logic signal will, by default, have the values displayed in the graph. To turn this off, un-select the **Show values** item in the **Options** menu.

You cannot change the clock signal's presentation.

## Changing the Height of an Analog Signal

To change the size of the analog signal, grab the bottom edge of a selected analog signal (as shown) and move the bottom up or down to make the analog signal smaller or bigger, respectively:

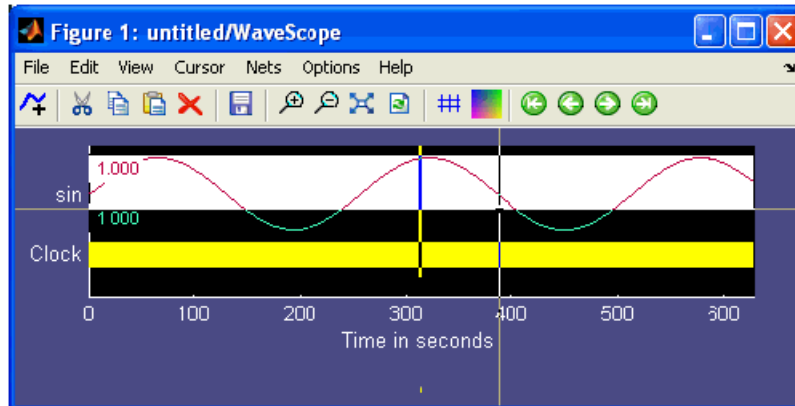

## Changing the Signal Name

Double-click on a signal's name to change it. You can also change the name on the wire in the model. In this case when the simulation is re-run or the WaveScope window is refreshed using the  button, the signal name is updated in the WaveScope window.

## Rainbowing the Signals

It is easier to observe signals when they are separated in the visual spectrum. As signals are added, a new color is selected from a rainbow palette. A group of signals can be re-rainbowed by selecting a group of signals and pushing the rainbow button. To re-rainbow all of the signals, select them all using Control-A and push the rainbow button:

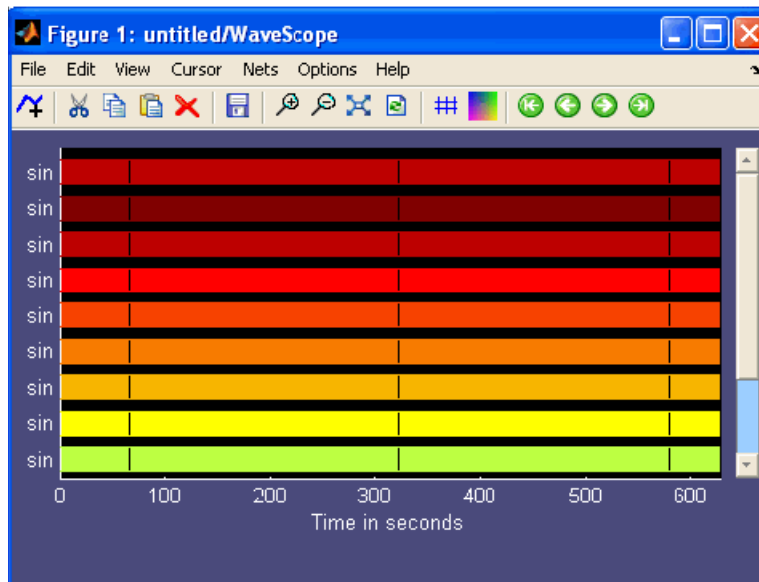

## Viewing the Signals

Once you have selected the signals and simulated the model, WaveScope starts displaying the signals.

## Zooming and Scrolling

You can zoom in and out with either the magnifying glass icons, the view menu, or the 'i' and 'o' keys on your keyboard. You can also zoom to a box by dragging a rubberband box in the WaveScope window. Arrow keys will scroll the display, or you can use your mouse in the sliders at the right and below the signal display. Note that when there is sufficient room to display the signals in one dimension or the other, the sliders will not display.

The control key allows for finer-resolution zooming and panning. Holding down the control key while pushing the left and right arrow keys will pan by one clock cycle. Holding down the control keys in conjunction with the 'i' and 'o' keys will zoom in and out by a smaller factor.

## Changing the Recording Limits

There are times when you can want to display only a subset of your data. For instance, your simulation can run for a long time, but you are only interested in looking at the last 1000 steps of the simulation.

The more data that is displayed in the WaveScope, the slower the WaveScope performs. One possibility is to zoom in on the desired data, but if there is a lot of data the WaveScope will still be slow. In this case a better solution is to reduce the Recording Limits of the WaveScope.

By default, WaveScope records all the values on a signal from start of a simulation to the finish. You can change these limits by using the **Options** menu and selecting the **Recording Limits** submenu. A dialog will open in which you can set the start and ending time for recording. As shown below, the dialog is pre-populated with the current lowest and highest value. You can enter any number here. The end time can be set to "Inf", as well, indicating no preset upper limit.

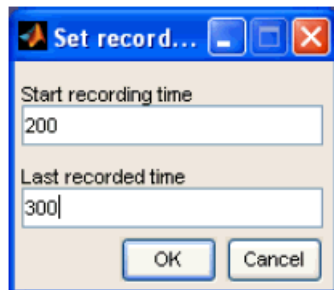

Once the recording limits are set, the WaveScope will only display values in that time range. You cannot zoom back out of that range. When you rerun the simulation, only the values at times in that range are recorded.



## The Grid

Displaying the Grid  – As shown below, clicking the "Toggle Grid" icon on the toolbar will display vertical lines at each labeled x-axis value.

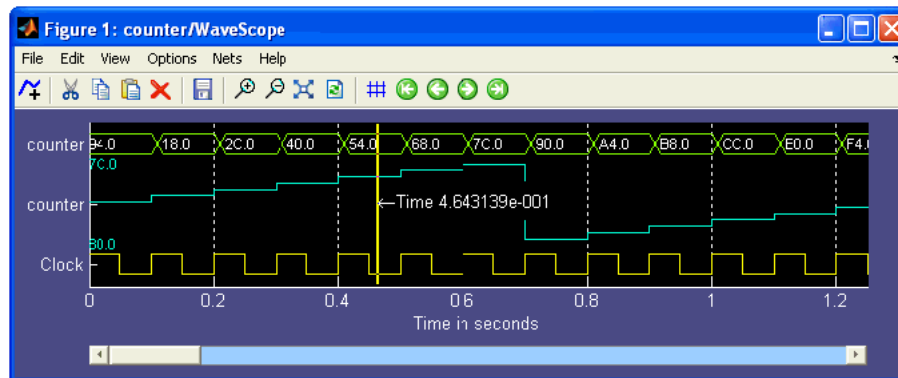

## The Cursor

The cursor is helpful for visually aligning signals or marking a point of interest. The cursor can be brought to the currently-viewed time span by clicking underneath the time axis. When moving the pointer underneath the time axis, the mouse pointer changes to a cross, indicating that the cursor can be moved to that location and moved around within the current view.

The cursor can also be brought to the center of the screen using the 'c' key or the **Cursor > Center Cursor** menu option. Once on-screen, the cursor can be moved around by dragging it. When the mouse pointer is placed over the cursor, the pointer will change to a cross to show that it can be dragged.

When the mouse pointer is over the cursor, a tool tip shows the value of the signal underneath the mouse pointer. This is valuable for displaying the value of an analog signal or the full value of a logical signal when the zoom factor is such that the full value cannot be displayed on the signal:

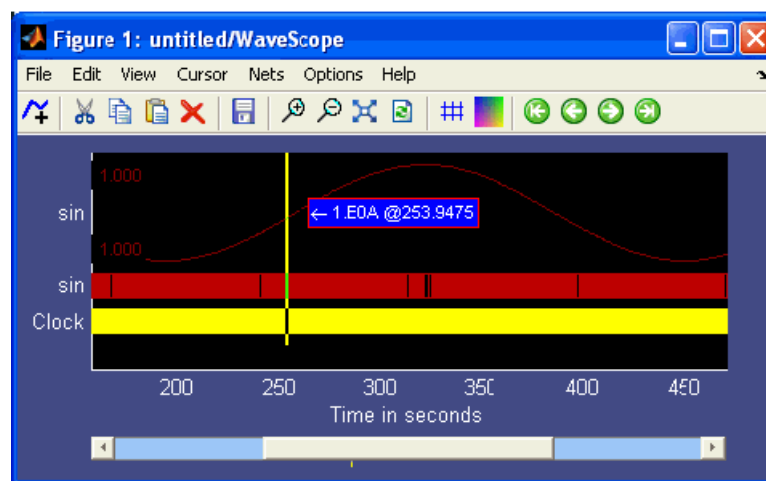

As the cursor is dragged, the tool tip is updated. Note the mini-cursor underneath the scroll bar, which appears as a yellow tick mark. When the cursor is not in the selected view, the mini-cursor shows where the cursor resides on the time axis. To jump to the current cursor location, use the 'j' key or the **Cursor > Jump to Cursor** menu option.

It is often helpful to be able to jump to the next signal transition without having to pan and search for the transition. To jump to the next transition, place the cursor on the screen and select the signal of interest. Press 'enter' or use the **Cursor > Move Cursor Next** menu option to move the cursor to the next signal transition. If the cursor moves off screen the view is panned to keep the cursor on screen.

## Crossprobing

When a signal(s) is selected in the WaveScope window, it is cross-probed by highlighting the corresponding wire in the model in orange, as shown here:

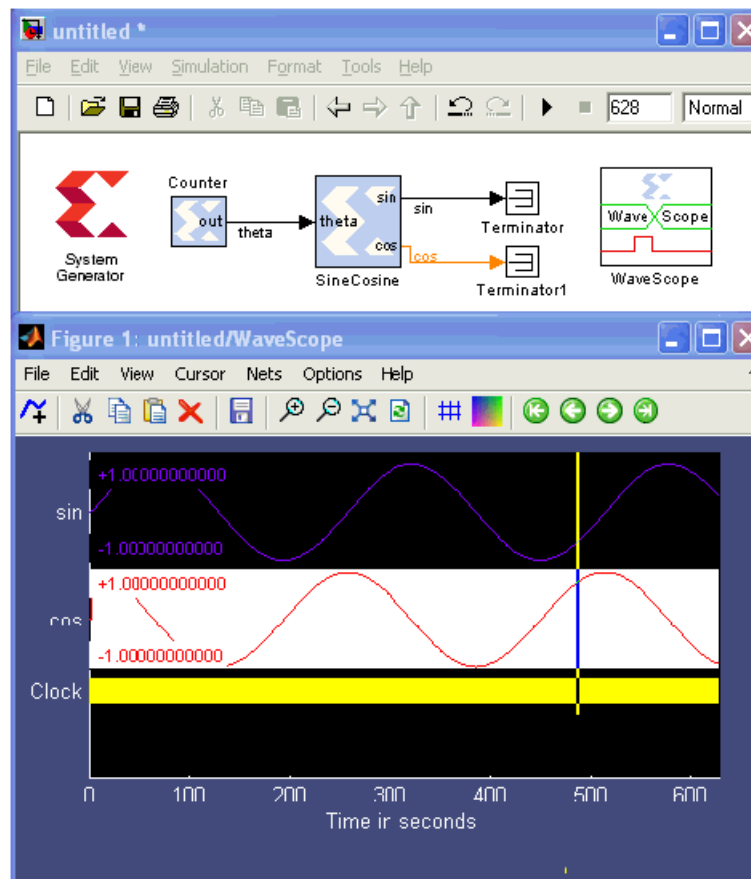

If the highlighted signal is underneath some layers of hierarchy, the appropriate mother blocks is highlighted in orange.

## The Cursor Menu

There are four options in the cursor menu.

### Center Cursor

This option will bring the cursor to the center of the currently-viewed time span. This action can also be performed with the 'c' key.

### Jump to Cursor

This option moves the current view to the cursor's location. This action can also be performed with the 'j' key.

### Move Cursor Next

This option moves the cursor to the next transition of the most recent of the currently-selected signals. This action can also be performed with the 'enter' key.

### Move Cursor Last

This option moves the cursor to the previous transition of the most recent of the currently-selected signals. This action can also be performed with shift-enter.

## The Options Menu

There are four options in the options menu.

### Grid Lines

This option toggles display of the time grid.

### Show Values

Show Values toggles the display of numerical values on the WaveScope. By default, WaveScope will display values. Turn off the display with this option.

### Run at End of Sim

This option toggles whether the WaveScope should run at the end of a simulation. By default, the WaveScope will display. If you don't want the WaveScope to appear at the end of simulation, use this option

### Recording Limits

As explained above in Changing the Recording Limits, this option is used to restrict the simulation time displayed in the WaveScope.



# *Xilinx Reference Blockset*

---

The following reference libraries are provided:

## Communication

### **Communication Reference Designs**

- [BPSK AWGN Channel](#)
- [Convolutional Encoder](#)
- [Multipath Fading Channel Model](#)
- [White Gaussian Noise Generator](#)

## Control Logic

### **Control Logic Reference Designs**

- [Mealy State Machine](#)
- [Moore State Machine](#)
- [Registered Mealy State Machine](#)
- [Registered Moore State Machine](#)

## DSP

### **DSP Reference Designs**

- [2 Channel Decimate by 2 MAC FIR Filter](#)
- [2n+1-tap Linear Phase MAC FIR Filter](#)
- [2n-tap Linear Phase MAC FIR Filter](#)
- [2n-tap MAC FIR Filter](#)
- [4-channel 8-tap Transpose FIR Filter](#)
- [4n-tap MAC FIR Filter](#)

### DSP Reference Designs

- [CIC Filter](#)
- [Dual Port Memory Interpolation MAC FIR Filter](#)
- [Interpolation Filter](#)
- [m-channel n-tap Transpose FIR Filter](#)
- [n-tap Dual Port Memory MAC FIR Filter](#)
- [n-tap MAC FIR Filter](#)

## Imaging

### Imaging Reference Designs

- [5x5Filter](#)
- [Virtex Line Buffer](#)
- [Virtex2 5 Line Buffer](#)
- [Virtex2 Line Buffer](#)

## Math

### Math Reference Designs

- [CORDIC ATAN](#)
- [CORDIC DIVIDER](#)
- [CORDIC LOG](#)
- [CORDIC SINCOS](#)
- [CORDIC SQRT](#)

## 2 Channel Decimate by 2 MAC FIR Filter

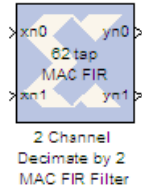

The Xilinx n-tap 2 Channel Decimate by 2 MAC FIR Filter reference block implements a multiply-accumulate-based FIR filter. One dedicated multiplier and one Dual Port Block RAM are used in the n-tap filter. The same MAC engine is used to process both channels that are time division multiplexed (TDM) together. Completely different coefficient sets can be specified for each channel as long as they have the same number of coefficients. The filter also provides a fixed decimation by 2 using a polyphase filter technique. The filter configuration helps illustrate techniques for storing multiple coefficient sets and data samples in filter design. The Virtex FPGA family (and Virtex family derivatives) provide dedicated circuitry for building fast, compact adders, multipliers, and flexible memory architectures. The filter design takes advantage of these silicon features by implementing a design that is compact and resource efficient.

Implementation details are provided in the filter design subsystems. To read the annotations, place the block in a model, then right-click on the block and select **Explore** from the popup menu. Double click on one of the sub-blocks to open the sub-block model and read the annotations.

### Block Parameters

The block parameters dialog box can be invoked by double-clicking the icon in your Simulink model.

Parameters specific to this reference block are as follows:

- **Data Input Bit Width:** Width of input sample.
- **Data Input Binary Point:** Binary point location of input.
- **Coefficient Vector (Ch.1):** Specify coefficients for Channel 1 of the filter. Number of taps is inferred from size of coefficient vector.
- **Coefficient Vector (Ch.2):** Specify coefficients for Channel 2 of the filter. Number of taps is inferred from size of coefficient vector.  
*Note:* Coefficient Vectors must be the same size. Pad coefficients if necessary to make them the same size.
- **Number of Bits per Coefficient:** Bit width of each coefficient.
- **Binary Point per Coefficient:** Binary point location for each coefficient.  
*Note:* Coefficient Vectors must be the same size. Pad coefficients if necessary to make them the same size.
- **Sample Period:** Sample period of input

### Reference

J. Hwang and J. Ballagh. *Building Custom FIR Filters Using System Generator*. 12th International Field-Programmable Logic and Applications Conference (FPL). Montpellier, France, September 2002. Lecture Notes in Computer Science 2438

## 2n+1-tap Linear Phase MAC FIR Filter



The Xilinx 2n+1-tap Linear Phase MAC FIR Filter reference block implements a multiply-accumulate-based FIR filter. The 2n+1-tap Linear Phase MAC FIR filter exploits coefficient symmetry for an odd number of coefficients to increase filter throughput. These filter designs exploit silicon features found in Virtex family FPGAs such as dedicated circuitry for building fast, compact adders, multipliers, and flexible memory architectures.

Implementation details are provided in the filter design subsystems. To read the annotations, place the block in a model, then right-click on the block and select **Explore** from the popup menu. Double click on one of the sub-blocks to open the sub-block model and read the annotations.

### Block Parameters

The block parameters dialog box can be invoked by double-clicking the icon in your Simulink model.

Parameters specific to this reference block are as follows:

- **Coefficients:** Specify coefficients for the filter. Number of taps is inferred from size of coefficient vector.
- **Number of Bits per Coefficient:** Bit width of each coefficient.
- **Binary Point for Coefficient:** Binary point location for each coefficient.
- **Number of Bits per Input Sample:** Width of input sample.
- **Binary Point for Input Samples:** Binary point location of input.
- **Input Sample Period:** Sample period of input.

### Reference

J. Hwang and J. Ballagh. *Building Custom FIR Filters Using System Generator*. 12th International Field-Programmable Logic and Applications Conference (FPL). Montpellier, France, September 2002. Lecture Notes in Computer Science 2438.



## 2n-tap Linear Phase MAC FIR Filter



The Xilinx 2n-tap linear phase MAC FIR filter reference block implements a multiply-accumulate-based FIR filter. The block exploits coefficient symmetry for an even number of coefficients to increase filter throughput. These filter designs exploit silicon features found in Virtex family FPGAs such as dedicated circuitry for building fast, compact adders, multipliers, and flexible memory architectures.

Implementation details are provided in the filter design subsystems. To read the annotations, place the block in a model, then right-click on the block and select **Explore** from the popup menu. Double click on one of the sub-blocks to open the sub-block model and read the annotations.

### Block Parameters

The block parameters dialog box can be invoked by double-clicking the icon in your Simulink model.

Parameters specific to this reference block are as follows:

- **Coefficients:** Specify coefficients for the filter. Number of taps is inferred from size of coefficient vector.
- **Number of Bits per Coefficient:** Bit width of each coefficient.
- **Binary Point for Coefficient:** Binary point location for each coefficient.
- **Number of Bits per Input Sample:** Width of input sample.
- **Binary Point for Input Samples:** Binary point location of input.
- **Input Sample Period:** Sample period of input.

### Reference

J. Hwang and J. Ballagh. *Building Custom FIR Filters Using System Generator*. 12th International Field-Programmable Logic and Applications Conference (FPL). Montpellier, France, September 2002. Lecture Notes in Computer Science 2438.

## 2n-tap MAC FIR Filter



The Xilinx 2n-tap MAC FIR Filter reference block implements a multiply-accumulate-based FIR filter. The three filter configurations help illustrate the tradeoffs between filter throughput and device resource consumption. The Virtex FPGA family (and Virtex family derivatives) provide dedicated circuitry for building fast, compact adders, multipliers, and flexible memory architectures. Each filter design takes advantage of these silicon features by implementing a design that is compact and resource efficient.

Implementation details are provided in the filter design subsystems. To read the annotations, place the block in a model, then right-click on the block and select **Explore** from the popup menu. Double click on one of the sub-blocks to open the sub-block model and read the annotations.

### Block Parameters

The block parameters dialog box can be invoked by double-clicking the icon in your Simulink model.

Parameters specific to this reference block are as follows:

- **Coefficients:** Specify coefficients for the filter. Number of taps is inferred from size of coefficient vector.
- **Number of Bits per Coefficient:** Bit width of each coefficient.
- **Binary Point for Coefficient:** Binary point location for each coefficient.
- **Number of Bits per Input Sample:** Width of input sample.
- **Binary Point for Input Samples:** Binary point location of input.
- **Input Sample Period:** Sample period of input.

### Reference

J. Hwang and J. Ballagh. *Building Custom FIR Filters Using System Generator*. 12th International Field-Programmable Logic and Applications Conference (FPL). Montpellier, France, September 2002. Lecture Notes in Computer Science 2438.

## 4-channel 8-tap Transpose FIR Filter



The Xilinx 4-channel 8-tap Transpose FIR Filter reference block implements a 4-channel 8-tap transpose FIR filter. The transpose structure is well suited for data path processing in Xilinx FPGAs, and is easily extended to produce larger filters (space accommodating). The filter takes advantage of silicon features found in the Virtex family FPGAs such as dedicated circuitry for building fast, compact adders, multipliers, and flexible memory architectures.

Implementation details are provided in the filter design subsystems. To read the annotations, place the block in a model, then right-click on the block and select **Explore** from the popup menu. Double click on one of the sub-blocks to open the sub-block model and read the annotations.

### Block Parameters

The block parameters dialog box can be invoked by double-clicking the icon in your Simulink model.

Parameters specific to this reference block are as follows:

- **Coefficients:** Specify coefficients for the filter. Number of taps is inferred from size of coefficient vector.
- **Number of Bits per Coefficient:** Bit width of each coefficient.
- **Binary Point for Coefficient:** Binary point location for each coefficient.
- **Number of Bits per Input Sample:** Width of input sample.
- **Binary Point for Input Samples:** Binary point location of input.
- **Input Sample Period:** Sample period of input.

## 4n-tap MAC FIR Filter

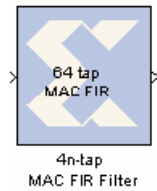

The Xilinx 4n-tap MAC FIR Filter reference block implements a multiply-accumulate-based FIR filter. The three filter configurations help illustrate the tradeoffs between filter throughput and device resource consumption. The Virtex FPGA family (and Virtex family derivatives) provide dedicated circuitry for building fast, compact adders, multipliers, and flexible memory architectures. Each filter design takes advantage of these silicon features by implementing a design that is compact and resource efficient.

Implementation details are provided in the filter design subsystems. To read the annotations, place the block in a model, then right-click on the block and select **Explore** from the popup menu. Double click on one of the sub-blocks to open the sub-block model and read the annotations.

### Block Parameters

The block parameters dialog box can be invoked by double-clicking the icon in your Simulink model.

Parameters specific to this reference block are as follows:

- **Coefficients:** Specify coefficients for the filter. Number of taps is inferred from size of coefficient vector.
- **Number of Bits per Coefficient:** Bit width of each coefficient.
- **Binary Point for Coefficient:** Binary point location for each coefficient.
- **Number of Bits per Input Sample:** Width of input sample.
- **Binary Point for Input Samples:** Binary point location of input.
- **Input Sample Period:** Sample period of input.

### Reference

J. Hwang and J. Ballagh. *Building Custom FIR Filters Using System Generator*. 12th International Field-Programmable Logic and Applications Conference (FPL). Montpellier, France, September 2002. Lecture Notes in Computer Science 2438.

## 5x5Filter



The Xilinx 5x5 Filter reference block is implemented using 5 n-tap MAC FIR Filters. The filters can be found in the DSP library of the Xilinx Reference Blockset.

Nine different 2-D filters have been provided to filter grayscale images. The filter can be selected by changing the mask parameter on the 5x5 Filter block. The 2-D filter coefficients are stored in a block RAM, and the model makes no specific optimizations for these coefficients. You can substitute your own coefficients and scale factor by modifying the mask of the 5x5 filter block, under the Initialization

tab.

The coefficients used are shown below for the 9 filters. The output of the filter is multiplied by the scale factor named <filter name>Div.

```
edge = [ 0 0 0 0 0; ...
        0 -1 -1 -1 0; ...
        0 -1 -1 -1 0; ...
        0 0 0 0 0];
edgeDiv = 1;
```

```
sobelX = [ 0 0 0 0 0; ...
          0 -1 0 1 0; ...
          0 -2 0 2 0; ...
          0 -1 0 1 0; ...
          0 0 0 0 0];
sobelXDiv = 1;
```

```
sobelY = [ 0 0 0 0 0; ...
          0 1 2 1 0; ...
          0 0 0 0 0; ...
          0 -1 -2 -1 0; ...
          0 0 0 0 0];
sobelYDiv = 1;
```

```
sobelXY = [ 0 0 0 0 0; ...
            0 0 -1 -1 0; ...
            0 1 0 -1 0; ...
            0 1 1 0 0; ...
            0 0 0 0 0];
sobelXYDiv = 1;
```

```
blur = [ 1 1 1 1 1; ...
        1 0 0 0 1; ...
        1 0 0 0 1; ...
        1 0 0 0 1; ...
        1 1 1 1 1];
blurDiv = 1/16;
```

```
smooth = [ 1 1 1 1 1; ...
           1 5 5 5 1; ...
           1 5 44 5 1; ...
           1 5 5 5 1; ...
           1 1 1 1 1];
smoothDiv = 1/100;
```

```

sharpen = [ 0  0  0  0 0; ...
0 -2 -2 -2 0; ...
0 -2 32 -2 0; ...
0 -2 -2 -2 0; ...
0  0  0  0 0];
sharpenDiv = 1/16;

gaussian = [1 1 2 1 1; ...
1 2 4 2 1; ...
2 4 8 4 2; ...
1 2 4 2 1; ...
1 1 2 1 1];
gaussianDiv = 1/52;

identity = [ 0  0  0  0 0; ...
0  0  0  0 0; ...
0  0  1  0 0; ...
0  0  0  0 0; ...
0  0  0  0 0];
identityDiv = 1;

```

This filter occupies 309 slices, 5 dedicated multipliers, and 5 block rams of a Xilinx xc2v250-6 part and operates at 213 MHz (advanced speeds files 1.96, ISE® 4.2.01i software).

The underlying 5-tap MAC FIR filters are clocked 5 times faster than the input rate. Therefore the throughput of the design is 213 MHz / 5 = 42.6 million pixels/ second. For a 64x64 image, this is  $42.6 \times 10^6 / (64 \times 64) = 10,400$  frames/sec. For a 256x256 image the throughput would be 650 frames /sec, and for a 512x512 image it would be 162 frames/sec.

## Block Parameters

The block parameters dialog box can be invoked by double-clicking the icon in your Simulink model.

Parameters specific to this reference block are as follows:

- **5x5 Mask:** The coefficients for an Edge, Sobel X, Sobel Y, Sobel X-Y, Blur, Smooth, Sharpen, Gaussian, or Identity filter can be selected.
- **Sample Period:** The sample period at which the input signal runs at is required

# BPSK AWGN Channel

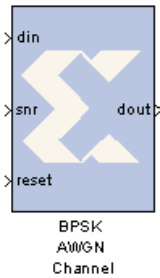

The Xilinx BPSK AWGN Channel reference block adds scaled white Gaussian noise to an input signal. The noise is created by the [White Gaussian Noise Generator](#) reference block.

The noise is scaled based on the SNR to achieve the desired noise variance, as shown below. The SNR is defined as  $(E_b/N_0)$  in dB for uncoded BPSK with unit symbol energy ( $E_s = 1$ ). The SNR input is UFix8\_4 and the valid range is from 0.0 to 15.9375 in steps of 0.0625dB.

To use the AWGN in a system with coding and/or to use the core with different modulation formats, it is necessary to adjust the SNR value to accommodate the difference in spectral efficiency. If we have BPSK modulation with rate 1/2 coding and keep  $E_s = 1$  and  $N_0$  constant, then  $E_b = 2$  and  $E_b/N_0 = SNR + 3$  dB. If we have uncoded QPSK modulation with  $I = +/-1$  and  $Q = +/-1$  and add independent noise sequences, then each channel looks like an independent BPSK channel and the  $E_b/N_0 = SNR$ . If we then add rate 1/2 coding to the QPSK case, we have  $E_b/N_0 = SNR + 3$  dB.

The overall latency of the AWGN Channel is 15 clock cycles. Channel output is a 17 bit signed number with 11 bits after the binary point. The input port snr can be any type. The reset port must be Boolean and the input port din must be of unsigned 1-bit type with binary point position at zero.

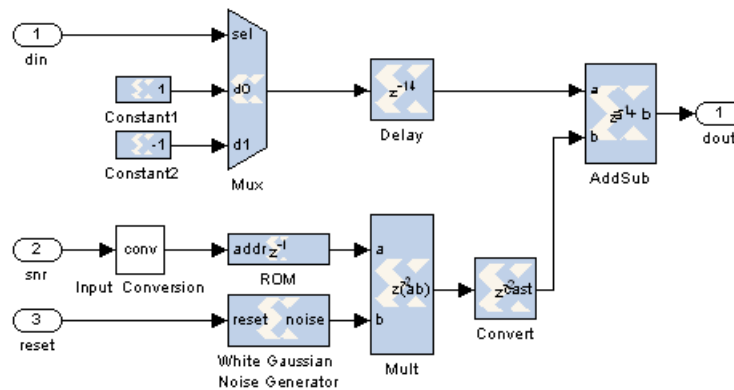

## Block Parameters

The block parameter is the decimal starting seed value.

## Reference

[1] A. Ghazel, E. Boutillon, J. L. Danger, G. Gulak and H. Laamari, *Design and Performance Analysis of a High Speed AWGN Communication Channel Emulator*, IEEE PACRIM Conference, Victoria, B. C., Aug. 2001.

[2] Xilinx Data Sheet: *Additive White Gaussian Noise (AWGN) Core v1.0*, Xilinx, Inc. October 2002

## CIC Filter

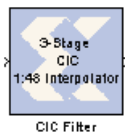

Cascaded integrator-comb (CIC) filters are multirate filters used for realizing large sample rate changes in digital systems. Both decimation and interpolation structures are supported. CIC filters contain no multipliers; they consist only of adders, subtractors and registers. They are typically employed in applications that have a large excess sample rate; that is, the system sample rate is much larger than the bandwidth occupied by the signal. CIC filters are frequently used in digital down-converters and digital up-converters.

Implementation details are provided in the filter design subsystems. To read the annotations, place the block in a model, then right-click on the block and select **Explore** from the popup menu. Double click on one of the sub-blocks to open the sub-block model and read the annotations.

### Block Interface

The CIC Block has a single data input port and a data output port:

- $x_n$  : data input port, can be between 1 and 128 bits (inclusive).
- $y_n$  : data output port

The two basic building blocks of a CIC filter are the integrator and the comb. A single integrator is a single-pole IIR filter with a transfer function of:

$$H(z) = (1 - z^{-1})^{-1}$$

The integrator's unity feedback coefficient is  $y[n] = y[n-1] + x[n]$ .

A single comb filter is an odd-symmetric FIR filter described by:

$$y[n] = x[n] - x[n - RM]$$

$M$  is the differential delay selected in the block dialog box, and  $R$  is the selected integer rate change factor. The transfer function for a single comb stage is

$$H(z) = 1 - z^{-RM}$$

As seen in the two figures below, the CIC filter cascades  $N$  integrator sections together with  $N$  comb sections. To keep the integrator and comb structures independent of rate change, a rate change block (for example, an up-sampler or down-sampler) is inserted between the sections. In the interpolator, the up-sampler causes a rate increase by a factor of  $R$  by inserting  $R-1$  zero-valued samples between consecutive samples of the comb section output. In the decimator, the down-sampler reduces the sample rate by a factor of  $R$  by taking subsamples of the output from the last integrator stage.

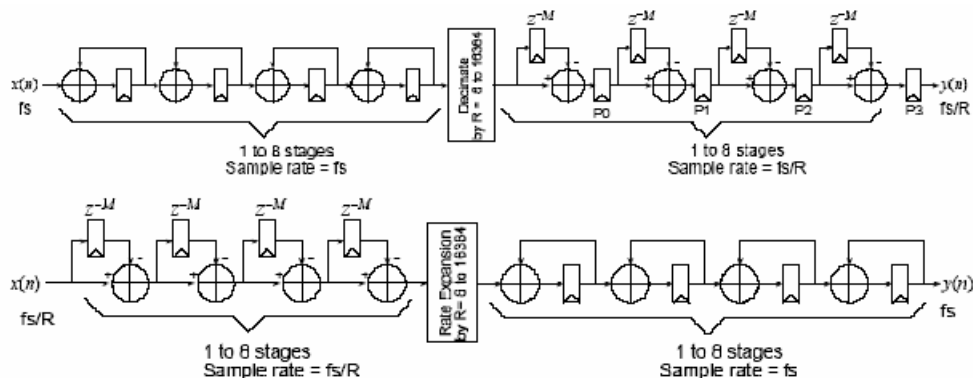



## Block Parameters

The block parameters dialog box can be invoked by double-clicking the icon in your Simulink model.

Parameters specific to this reference block are as follows:

- **Input Bit Width:** Width of input sample.
- **Input Binary Point:** Binary point location of input.
- **Filter Type:** Interpolator or Decimator
- **Sample Rate Change:** 8 to 16384 (inclusive)
- **Number of Stages:** 1 to 32 (inclusive)
- **Differential Delay:** 1 to 4 (inclusive)
- **Pipeline Differentiators:** On or Off

## Reference

E. B. Hogenauer. *An economical class of digital filters for decimation and interpolation*. IEEE Transactions on Acoustics, Speech and Signal Processing, ASSP- 29(2):155{162, 1981

## Convolutional Encoder



The Xilinx Convolutional Encoder Model block implements an encoder for convolutional codes. Ordinarily used in tandem with a Viterbi decoder, this block performs forward error correction (FEC) in digital communication systems.

Values are encoded using a linear feed forward shift register which computes modulo-two sums over a sliding window of input data, as shown in the figure below. The length of the shift register is specified by the constraint length. The convolution codes specify which bits in the data window contribute to the modulo-two sum. Resetting the block will set the shift register to zero. The encoder rate is the ratio of input to output bit length; thus, for example a rate 1/2 encoder outputs two bits for each input bit. Similarly, a rate 1/3 encoder outputs three bits for each input bit.

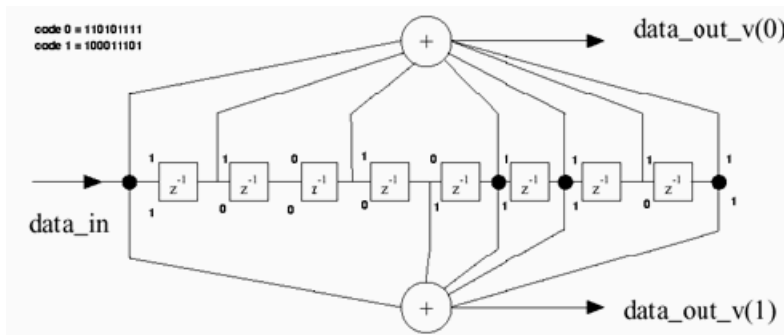

### Implementation

The block is implemented using a form of parameterizable mux-based collapsing. In this method constants drive logic blocks. Here the constant is the convolution code which is used to determine which register in the linear feed forward shift register is to be used in computing the output. All logic driven by a constant is optimized away by the down stream logic synthesis tool.

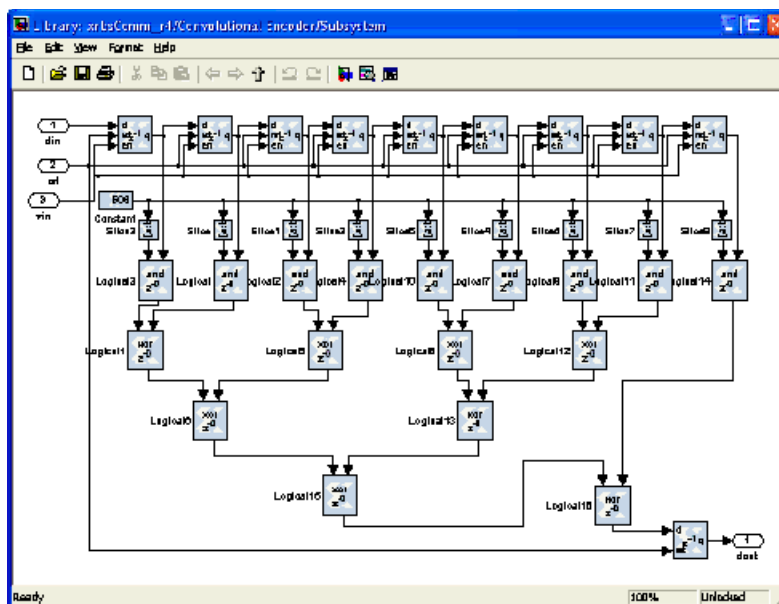

## Block Interface

The block currently has three input ports and three output ports. The `din` port must have type `UFix1_0`. It accepts the values to be encoded. The `vin` port indicates that the values presented on `din` are valid. Only valid values are encoded. The `rst` port will reset the convolution encoder when high. To add an enable port, you can open the subsystem and change the constant "Enable" to an input port. The output ports `dout1` and `dout2` output the encoded data. The port `dout1` corresponds to the first code in the array, `dout2` to the second, and so on. To add additional output ports, open the subsystem and follow the directions in the model. The output port `vout` indicates the validity of output values.

## Block Parameters

The block parameters dialog box can be invoked by double-clicking the icon in your Simulink model.

Parameters specific to this reference block are as follows:

- **Constraint Length:** Equals  $n+1$ , where  $n$  is the length of the constraint register in the encoder
- **Convolutional code array (octal):** Array of octal convolution codes. Output rate is derived from the array length. Between 2 and 7 (inclusive) codes can be entered

## CORDIC ATAN

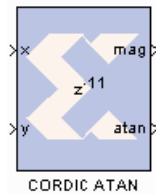

The Xilinx CORDIC ATAN reference block implements a rectangular-to-polar coordinate conversion using a fully parallel CORDIC (COordinate Rotation DIgital Computer) algorithm in Circular Vectoring mode.

That is, given a complex-input  $\langle x, y \rangle$ , it computes a new vector  $\langle m, a \rangle$ , where magnitude  $m = K \times \sqrt{x^2 + y^2}$ , and the angle  $a = \arctan(y/x)$ . As is common, the magnitude scale factor  $K = 1.646760\dots$  is not compensated in the processor, for example, the magnitude output should be scaled by this factor. The CORDIC processor is implemented using building blocks from the Xilinx blockset.

The CORDIC ATAN algorithm is implemented in the following 3 steps:

1. **Coarse Angle Rotation.** The algorithm converges only for angles between  $-\pi/2$  and  $\pi/2$ , so if  $x < 0$ , the input vector is reflected to the 1st or 3rd quadrant by making the x-coordinate non-negative.
2. **Fine Angle Rotation.** For rectangular-to-polar conversion, the resulting vector is rotated through progressively smaller angles, such that  $y$  goes to zero. In the  $i$ -th stage, the angular rotation is by either  $\pm \arctan(1/2^i)$ , depending on whether or not its input  $y$  is less than or greater than zero.
3. **Angle Correction.** If there was a reflection applied in Step 1, this step applies the appropriate angle correction by subtracting it from  $\pm \pi$ .

### Block Parameters

The block parameters dialog box can be invoked by double-clicking the icon in your Simulink model.

Parameters specific to this reference block are as follows:

- **Number of Processing Elements:** specifies the number of iterative stages used for fine angle rotation.
- **X,Y Data Width:** specifies the width of the inputs  $x$  and  $y$ . The inputs  $x$ , and  $y$  should be signed data type having the same data width.
- **X,Y Binary Point Position:** specifies the binary point position for inputs  $x$  and  $y$ . The inputs  $x$  and  $y$  should be signed data type with the same binary point position.
- **Latency for each Processing element:** This parameter sets the pipeline latency after each circular rotation stage.

The latency of the CORDIC arc tangent block is calculated based on the formula specified as follows: Latency = 3 + sum (latency of Processing Elements)

### Reference

- 1) J. E. Volder, *The CORDIC Trigonometric Computing Technique*, IRE Trans. On Electronic Computers, Vol. EC-8, 1959, pp. 330-334.
- 2) J. S. Walther, *A Unified Algorithm for Elementary Functions*, Spring Joint Computer Conference (1971) pp. 379-385.
- 3) Yu Hen Hu, *CORDIC-Based VLSI Architectures for Digital Signal Processing*, IEEE Signal Processing Magazine, pp. 17-34, July 1992.

## CORDIC DIVIDER

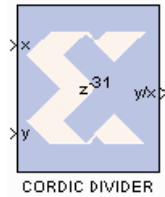

The Xilinx CORDIC DIVIDER reference block implements a divider circuit using a fully parallel CORDIC (COordinate Rotation DIgital Computer) algorithm in Linear Vectoring mode.

That is, given an input  $\langle x, y \rangle$ , it computes the output  $y/x$ . The CORDIC processor is implemented using building blocks from the Xilinx blockset.

The CORDIC divider algorithm is implemented in the following 4 steps:

1. **Co-ordinate Rotation.** The CORDIC algorithm converges only for positive values of  $x$ . The input vector is always mapped to the 1st quadrant by making the  $x$  and  $y$  coordinate non-negative. The divider circuit has been designed to converge for all values of  $X$  and  $Y$ , except for the most negative value.
2. **Normalization.** The CORDIC algorithm converges only for  $y$  less than or equal to  $2x$ . The inputs  $x$  and  $y$  are shifted to the left until they have a 1 in the most significant bit (MSB). The relative shift of  $y$  over  $x$  is recorded and passed on to the co-ordinate correction stage.
3. **Linear Rotations.** For ratio calculation, the resulting vector is rotated through progressively smaller angles, such that  $y$  goes to zero. In the final stage, the rotation yields  $y/x$ .
4. **Co-ordinate Correction.** Based on the co-ordinate axis and a relative shift applied to  $y$  over  $x$ , this step assigns the appropriate sign to the resulting ratio and multiplies it with  $2^{\text{(relative shift of } y \text{ over } x)}}$ .

### Block Parameters

The block parameters dialog box can be invoked by double-clicking the icon in your Simulink model.

Parameters specific to this reference block are as follows:

- **Number of Processing Elements** specifies the number of iterative stages used for linear rotation.
- **X,Y Data Width:** specifies the width of the inputs  $x$  and  $y$ . The inputs  $x$  and  $y$  should be signed data type with the same data width.
- **X,Y Binary Point Position:** specifies the binary point position for inputs  $x$  and  $y$ . The inputs  $x$  and  $y$  should be signed data type with the same binary point position.
- **Latency for each Processing element:** This parameter sets the pipeline latency after each iterative linear rotation stage.

The latency of the CORDIC divider block is calculated based on the formula specified as follows:  
 Latency = 4 + data width + sum (latency of Processing Elements)

### Reference

1. J. E. Volder, *The CORDIC Trigonometric Computing Technique*, IRE Trans. On Electronic Computers, Vol. EC-8, 1959, pp. 330-334.
2. J. S. Walther, *A Unified Algorithm for Elementary Functions*, Spring Joint Computer Conference (1971) pp. 379-385.
3. Yu Hen Hu, *CORDIC-Based VLSI Architectures for Digital Signal Processing*, IEEE Signal Processing Magazine, pp. 17-34, July 1992.

## CORDIC LOG

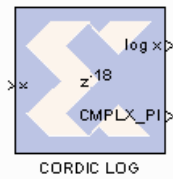

The Xilinx CORDIC LOG reference block implements a natural logarithm circuit using a fully parallel CORDIC (COordinate Rotation DIgital Computer) algorithm in Hyperbolic Vectoring mode.

That is, given an input  $x$ , it computes the output  $\log(x)$  and also provides a flag for adding complex pi value to the output if a complex output is desired. The CORDIC processor is implemented using building blocks from the Xilinx blockset.

The natural logarithm is calculated indirectly by the CORDIC algorithm by applying the identities listed below.

$$\log(w) = 2 \times \tanh^{-1}[(w-1)/(w+1)]$$

$$\log(w \times 2^E) = \log(w) + E \times \log(2)$$

The CORDIC LOG algorithm is implemented in the following 4 steps:

1. **Co-ordinate Rotation:** The CORDIC algorithm converges only for positive values of  $x$ . If  $x < 0$ , the input data is converted to a non-negative number. If  $x = 0$ , a zero detect flag is passed along to the last stage which can be exposed at the output stage. The log circuit has been designed to converge for all values of  $x$ , except for the most negative value.
2. **Normalization:** The CORDIC algorithm converges only for  $x$ , between the values 0.5 (inclusive) and 1. During normalization, the input  $X$  is shifted to the left till it has a 1 in the most significant bit. The log output is derived using the identity  $\log(w) = 2 \times \tanh^{-1}\{(w-1)/(w+1)\}$ . Based on this identity, the input  $w$  gets mapped to,  $x = w + 1$  and  $y = w - 1$ .
3. **Linear Rotations:** For  $\tanh^{-1}\{(w-1)/(w+1)\}$  calculation, the resulting vector is rotated through progressively smaller angles, such that  $y$  goes to zero.
4. **Co-ordinate Correction:** If the input was negative a CMPLX\_PI flag is provided at the output for adding PI if a complex output is desired. If a left shift was applied to  $X$ , this step adjusts the output by using the equation  $\log(w \times 2^E) = \log(w) + E \times \log(2)$ .

### Block Parameters

The block parameters dialog box can be invoked by double-clicking the icon in your Simulink model.

Parameters specific to this reference block are as follows:

- **Number of Processing Elements (integer value starting from 1):** specifies the number of iterative stages used for hyperbolic rotation.
- **Input Data Width:** specifies the width of input  $x$ . The inputs  $x$  should be signed data type having the same data width.
- **Input Binary Point Position:** specifies the binary point position for input  $x$ . The input  $x$  should be signed data type with the same binary point position.
- **Latency for each Processing Element [1001]:** This parameter sets the pipeline latency after each circular rotation stage.

The latency of the CORDIC LOG block is calculated based on the formula specified as follows:  
 Latency = 2 + Data Width + sum (latency of Processing Elements).

## Reference

1. J. E. Volder, *The CORDIC Trigonometric Computing Technique*, IRE Trans. On Electronic Computers, Vol. EC-8, 1959, pp. 330-334.
2. J. S. Walther, *A Unified Algorithm for Elementary Functions*, Spring Joint Computer Conference (1971) pp. 379-385.
3. Yu Hen Hu, *CORDIC-Based VLSI Architectures for Digital Signal Processing*, IEEE Signal Processing Magazine, pp. 17-34, July 1992.

## CORDIC SINCOS

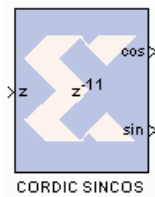

The Xilinx CORDIC SINCOS reference block implements Sine and Cosine generator circuit using a fully parallel CORDIC (COordinate Rotation DIgital Computer) algorithm in Circular Rotation mode.

That is, given input angle  $z$ , it computes the output cosine ( $z$ ) and sine ( $z$ ). The CORDIC processor is implemented using building blocks from the Xilinx blockset. The CORDIC sine cosine algorithm is implemented in the following 3 steps:

1. **Coarse Angle Rotation.** The algorithm converges only for angles between  $-\pi/2$  and  $\pi/2$ . If  $z > \pi/2$ , the input angle is reflected to the 1st quadrant by subtracting  $\pi/2$  from the input angle. When  $z < -\pi/2$ , the input angle is reflected back to the 3rd quadrant by adding  $\pi/2$  to the input angle. The sine cosine circuit has been designed to converge for all values of  $z$ , except for the most negative value.
2. **Fine Angle Rotation.** By setting  $x$  equal to  $1/1.646760$  and  $y$  equal to  $0$ , the rotational mode CORDIC processor yields cosine and sine of the input angle  $z$ .
3. **Co-ordinate Correction.** If there was a reflection applied in Step 1, this step applies the appropriate correction.

For  $z > \pi/2$ : using  $z = t + \pi/2$ , then

$$\sin(z) = \sin(t)\cos(\pi/2) + \cos(t)\sin(\pi/2) = \cos(t)$$

$$\cos(z) = \cos(t)\cos(\pi/2) - \sin(t)\sin(\pi/2) = -\sin(t)$$

For  $z < -\pi/2$ : using  $z = t - \pi/2$ , then

$$\sin(z) = \sin(t)\cos(-\pi/2) + \cos(t)\sin(-\pi/2) = -\cos(t)$$

$$\cos(z) = \cos(t)\cos(-\pi/2) - \sin(t)\sin(-\pi/2) = \sin(t)$$

### Block Parameters

The block parameters dialog box can be invoked by double-clicking the icon in your Simulink model.

Parameters specific to this reference block are as follows:

- **Number of Processing Elements:** specifies the number of iterative stages used for linear rotation.
- **Input Data Width:** specifies the width of the input  $z$ . The input  $z$  should be signed data type with the same data width as specified.
- **Input Binary Point Position:** specifies the binary point position for input  $z$ . The input  $z$  should be signed data type with the same binary point position. The binary point should be chosen to provide enough bits for representing  $\pi/2$ .
- **Latency for each Processing element:** This parameter sets the pipeline latency after each iterative circular rotation stage. The latency of the CORDIC SINCOS block is calculated based on the formula specified as follows: Latency =  $3 + \text{sum}(\text{latency of Processing Elements})$

### Reference

- 1) J. E. Volder, *The CORDIC Trigonometric Computing Technique*, IRE Trans. On Electronic Computers, Vol. EC-8, 1959, pp. 330-334.
- 2) J. S. Walther, *A Unified Algorithm for Elementary Functions*, Spring Joint Computer Conference (1971) pp. 379-385.
- 3) Yu Hen Hu, *CORDIC-Based VLSI Architectures for Digital Signal Processing*, IEEE Signal Processing Magazine, pp. 17-34, July 1992.



## CORDIC SQRT

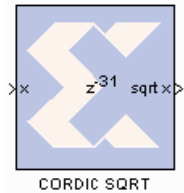

The Xilinx CORDIC SQRT reference block implements a square root circuit using a fully parallel CORDIC (COordinate Rotation DIgital Computer) algorithm in Hyperbolic Vectoring mode.

That is, given input  $x$ , it computes the output  $\text{sqrt}(x)$ . The CORDIC processor is implemented using building blocks from the Xilinx blockset.

The square root is calculated indirectly by the CORDIC algorithm by applying the identity listed as follows.  $\text{sqrt}(w) = \text{sqrt} \{ (w + 0.25)^2 - (w - 0.25)^2 \}$

The CORDIC square root algorithm is implemented in the following 4 steps:

1. **Co-ordinate Rotation:** The CORDIC algorithm converges only for positive values of  $x$ . If  $x < 0$ , the input data is converted to a non-negative number. If  $x = 0$ , a zero detect flag is passed to the co-ordinate correction stage. The square root circuit has been designed to converge for all values of  $x$ , except for the most negative value.
2. **Normalization:** The CORDIC algorithm converges only for  $x$  between 0.25 (inclusive) and 1. During normalization, the input  $x$  is shifted to the left till it has a 1 in the most significant non-signed bit. If the left shift results in an odd number of shift values, a right shift is performed resulting in an even number of left shifts. The shift value is divided by 2 and passed on to the co-ordinate correction stage. The square root is derived using the identity  $\text{sqrt}(w) = \text{sqrt} \{ (w + 0.25)^2 - (w - 0.25)^2 \}$ . Based on this identity the input  $x$  gets mapped to,  $X = x + 0.25$  and  $Y = x - 0.25$ .
3. **Hyperbolic Rotations:** For  $\text{sqrt}(X^2 - Y^2)$  calculation, the resulting vector is rotated through progressively smaller angles, such that  $Y$  goes to zero.
4. **Co-ordinate Correction:** If the input was negative and a left shift was applied to  $x$ , this step assigns the appropriate sign to the output and multiplies it with  $2^{-\text{shift}}$ . If the input was zero, the zero detect flag is used to set the output to 0.

### Block Parameters

The block parameters dialog box can be invoked by double-clicking the icon in your Simulink model.

Parameters specific to this reference block are as follows:

- **Number of Processing Elements (integer value starting from 1):** specifies the number of iterative stages used for linear rotation.
- **Input Data Width:** specifies the width of the inputs  $x$ . The input  $x$  should be signed data type with the same data width as specified.
- **Input Binary Point Position:** specifies the binary point position for input  $x$ . The input  $x$  should be signed data type with the specified binary point position.
- **Latency for each Processing Element [1001]:** This parameter sets the pipeline latency after each iterative hyperbolic rotation stage.

The latency of the CORDIC square root block is calculated based on the formula specified below:

$$\begin{aligned} \text{Latency} &= 7 + (\text{data width} - \text{binary point}) \\ &+ \text{mod} \{ (\text{data width} - \text{binary point}), 2 \} \\ &+ \text{sum} (\text{latency of Processing Elements}) \end{aligned}$$

## Reference

- 1) J. E. Volder, *The CORDIC Trigonometric Computing Technique*, IRE Trans. On Electronic Computers, Vol. EC-8, 1959, pp. 330-334.
- 2) J. S. Walther, *A Unified Algorithm for Elementary Functions*, Spring Joint Computer Conference (1971) pp. 379-385.
- 3) Yu Hen Hu, *CORDIC-Based VLSI Architectures for Digital Signal Processing*, IEEE Signal Processing Magazine, pp. 17-34, July 1992.

## Dual Port Memory Interpolation MAC FIR Filter

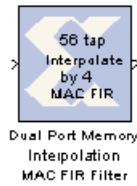

The Xilinx Dual Port Memory Interpolation MAC FIR filter reference block implements a multiply-accumulate-based FIR filter to perform a user-selectable interpolation. One dedicated multiplier and one Dual Port Block RAM are used in the n-tap filter. The filter configuration helps illustrate a cyclic RAM buffer technique for storing coefficients and data samples in a single block ram. The filter allows users to select the interpolation factor they require. The Virtex FPGA family (and Virtex family derivatives) provide dedicated circuitry for building fast, compact adders, multipliers, and flexible memory architectures. The filter design takes advantage of these silicon features by implementing a design that is compact and resource-efficient.

Implementation details are provided in the filter design subsystems. To read the annotations, place the block in a model, then right-click on the block and select **Explore** from the popup menu. Double click on one of the sub-blocks to open the sub-block model and read the annotations.

### Block Parameters

The block parameters dialog box can be invoked by double-clicking the icon in your Simulink model.

Parameters specific to this reference block are as follows:

- **Data Input Bit Width:** Width of input sample.
- **Data Input Binary Point:** Binary point location of input.
- **Coefficients:** Specify coefficients for the filter. Number of taps is inferred from size of coefficient vector.
- **Number of Bits per Coefficient:** Bit width of each coefficient.
- **Binary Point Per Coefficient:** Binary point location for each coefficient.
- **Interpolation Ratio:** Select the Interpolation Ratio of the filter (2 to 10, inclusive).
- **Sample Period:** Sample period of input.

### Reference

J. Hwang and J. Ballagh. *Building Custom FIR Filters Using System Generator*. 12th International Field-Programmable Logic and Applications Conference (FPL). Montpellier, France, September 2002. Lecture Notes in Computer Science 2438.

## Interpolation Filter

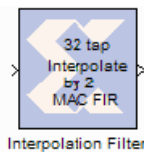

The Xilinx n-tap Interpolation Filter reference block implements a multiply-accumulate-based FIR filter to perform a user selected interpolation. One dedicated multiplier and one Dual Port Block RAM are used in the n-tap filter. The filter configuration helps illustrate a cyclic RAM buffer technique for storing coefficients and data samples in a single block ram. The filter allows users to select the interpolation factor they require. The Virtex FPGA family (and Virtex family derivatives) provide dedicated circuitry for building fast, compact adders, multipliers, and flexible memory architectures. The filter design takes advantage of these silicon features by implementing a design that is compact and resource efficient.

Implementation details are provided in the filter design subsystems. To read the annotations, place the block in a model, then right-click on the block and select **Explore** from the popup menu. Double click on one of the sub-blocks to open the sub-block model and read the annotations.

### Block Parameters

The block parameters dialog box can be invoked by double-clicking the icon in your Simulink model.

Parameters specific to this reference block are as follows:

- **Input Data Bit Width:** Width of input sample.
- **Input Data Binary Point:** Binary point location of input.
- **Coefficients:** Specify coefficients for the filter. Number of taps is inferred from size of coefficient vector.
- **Number of Bits per Coefficient:** Bit width of each coefficient.
- **Binary Point per Coefficient:** Binary point location for each coefficient.
- **Interpolation Factor:** Select the Interpolation Ratio of the filter. Range from 2 to 10.
- **Sample Period:** Sample period of input.

### Reference

J. Hwang and J. Ballagh. *Building Custom FIR Filters Using System Generator*. 12th International Field-Programmable Logic and Applications Conference (FPL). Montpellier, France, September 2002. Lecture Notes in Computer Science 2438

## m-channel n-tap Transpose FIR Filter

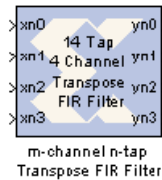

The Xilinx m-channel n-tap Transpose FIR Filter uses a fully parallel architecture with Time Division Multiplexing. The Virtex FPGA family (and Virtex family derivatives) provide dedicated shift register circuitry called the SRL16E, which are exploited in the architecture to achieve optimal implementation of the multichannel architecture. The Time Division Multiplexer and Time Division Demux can be selected to be implemented or not. Embedded Multipliers are used for the multipliers.

As the number of coefficients changes so to does the structure underneath as it is a dynamically built model.

Implementation details are provided in the filter design subsystems. To read the annotations, place the block in a model, then right-click on the block and select **Explore** from the popup menu. Double click on one of the sub-blocks to open the sub-block model and read the annotations.

### Block Parameters

The block parameters dialog box can be invoked by double-clicking the icon in your Simulink model.

Parameters specific to this reference block are as follows:

- **Input Bit Width:** Width of input sample.
- **Input Binary Point:** Binary point location of input.
- **Coefficients:** Specify coefficients for the filter. Number of taps is inferred from size of coefficient vector.
- **Coefficients Bit Width:** Bit width of each coefficient.
- **Coefficients Binary Point:** Binary point location for each coefficient.
- **Number of Channels:** Specify the number of channels desired. There is no limit to the number of channels supported.
- **Time Division Multiplexer Front End:** The TDM front-end circuit can be implemented or not (if the incoming data is already TDM)
- **Time Division DeMultiplexer Back End:** The TDD back-end circuit can be implemented or not (if you desire a TDM output). This is useful if the filter feeds another multichannel structure.
- **Input Sample Period:** Sample period of input.

## Mealy State Machine

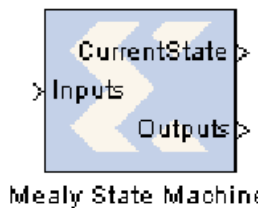

A “Mealy machine” is a finite state machine whose output is a function of state transition, for example, a function of the machine’s current state and current input. A Mealy machine can be described with the following block diagram:

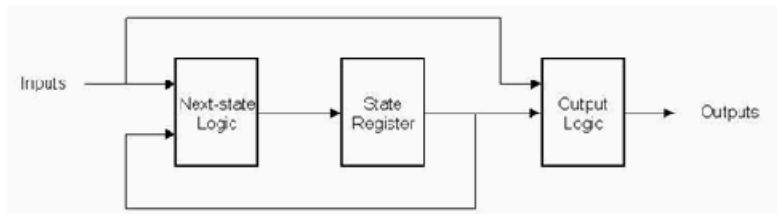

There are many ways to implement such state machines in System Generator (e.g., using the MCode block to implement the transition function, and registers to implement state variables). This reference block provides a method for implementing a Mealy machine using block and distributed memory. The implementation is very fast and efficient. For example, a state machine with 8 states, 1 input, and 2 outputs that are registered can be realized with a single block RAM that runs at more than 150 MHz in a Xilinx Virtex device.

The transition function and output mapping are each represented as an  $N \times M$  matrix, where  $N$  is the number of states, and  $M$  is the size of the input alphabet (e.g.,  $M = 2$  for a binary input). It is convenient to number rows and columns from  $0$  to  $N - 1$  and  $0$  to  $M - 1$  respectively. Each state is represented as an unsigned integer from  $0$  to  $N - 1$ , and each alphabet character is represented as an unsigned integer from  $0$  to  $M - 1$ . The row index of each matrix represents the current state, and the column index represents the input character

For the purpose of discussion, let  $F$  be the  $N \times M$  transition function matrix, and  $O$  be the  $N \times M$  output function matrix. Then  $F(i,j)$  is the next state when the current state is  $i$  and the current input character is  $j$ , and  $O(i,j)$  is the corresponding output of the Mealy machine.

### Example

Consider the problem of designing a Mealy machine to recognize the pattern '1011' in a serial stream of bits. The state transition diagram and equivalent transition table are shown below.

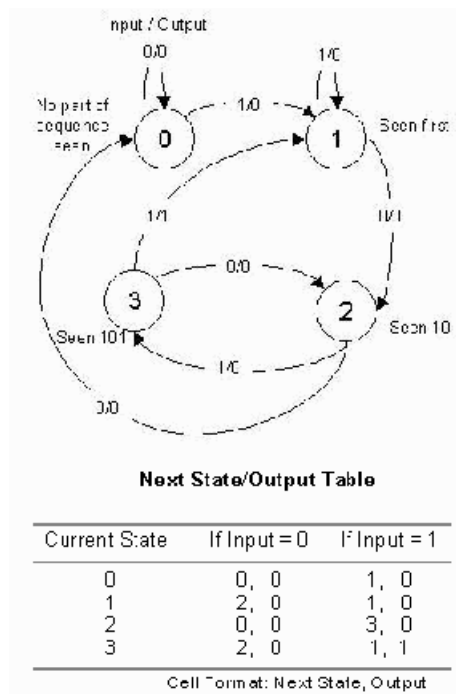

The table lists the next state and output that result from the current state and input. For example, if the current state is 3 and the input is 1, the next state is 1 and the output is 1, indicating the detection of the desired sequence.

The Mealy State Machine block is configured with next state and output matrices obtained from the next state/output table discussed above. These matrices are constructed as shown below:

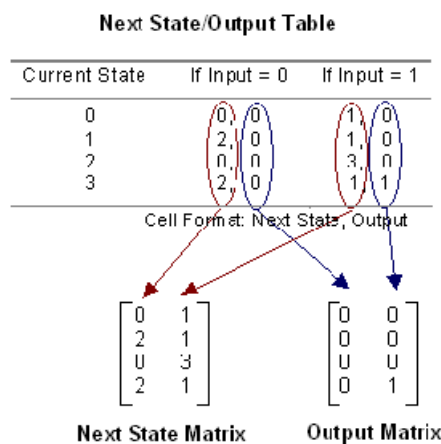

### Block Parameters

The block parameters dialog box can be invoked by double-clicking the icon in your Simulink model.

The next state logic, state register, and output logic are implemented using high speed dedicated block RAM. The output logic is implemented using a distributed RAM configured as a lookup table, and therefore has zero latency.

The number of bits used to implement a Mealy state machine is given by the equations:

$$depth = (2^k)(2^i) = 2^{k+i}$$

$$width = k+o$$

$$N = depth * width = (k+o)(2^{k+i})$$

where

N = total number of block RAM bits

s = number of states

k =  $\text{ceil}(\log_2(s))$

i = number of input bits

o = number of output bits



The following table gives examples of block RAM sizes necessary for various state machines:

Number of States	Number of Input Bits	Number of Output Bits	Block RAM Bits Needed
2	5	10	704
4	1	2	32
8	6	7	5120
16	5	4	4096
32	4	3	4096
52	1	11	2176
100	4	5	24576

The block RAM width and depth limitations are described in the online help for the Single Port RAM block.

## Moore State Machine

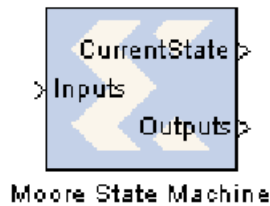

A "Moore machine" is a finite state machine whose output is only a function of the machine's current state. A Moore state machine can be described with the following block diagram:

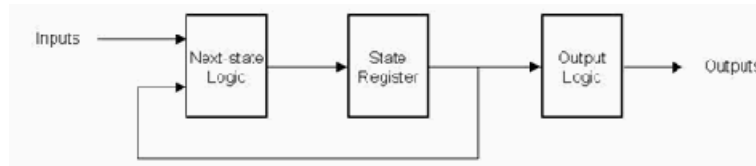

There are many ways to implement such state machines in System Generator (e.g., using the MCode block to implement the transition function, and registers to implement state variables). This reference block provides a method for implementing a Moore machine using block and distributed memory. The implementation is very fast and efficient. For example, a state machine with 8 states, 1 input, and 2 outputs that are registered can be realized with a single block RAM that runs at more than 150 MHz in a Xilinx Virtex device.

The transition function and output mapping are each represented as an  $N \times M$  matrix, where  $N$  is the number of states, and  $M$  represents the number of possible input values (e.g.,  $M = 2$  for a one bit input). It is convenient to number rows and columns from 0 to  $N - 1$  and 0 to  $M - 1$  respectively. Each state is represented as an unsigned integer from 0 to  $N - 1$ , and each alphabet character is represented as an unsigned integer from 0 to  $M - 1$ . The row index of each matrix represents the current state, and the column index represents the input character.

For the purpose of discussion, let  $F$  be the  $N \times M$  transition function matrix, and  $O$  be the  $N \times M$  output function matrix. Then  $F(i, j)$  is the next state when the current state is  $i$  and the current input character is  $j$ , and  $O(i, j)$  is the corresponding output of the Moore machine.

### Example

Consider the problem of designing a Moore machine to recognize the pattern '1011' in a serial stream of bits. The state transition diagram and equivalent transition table are shown below:

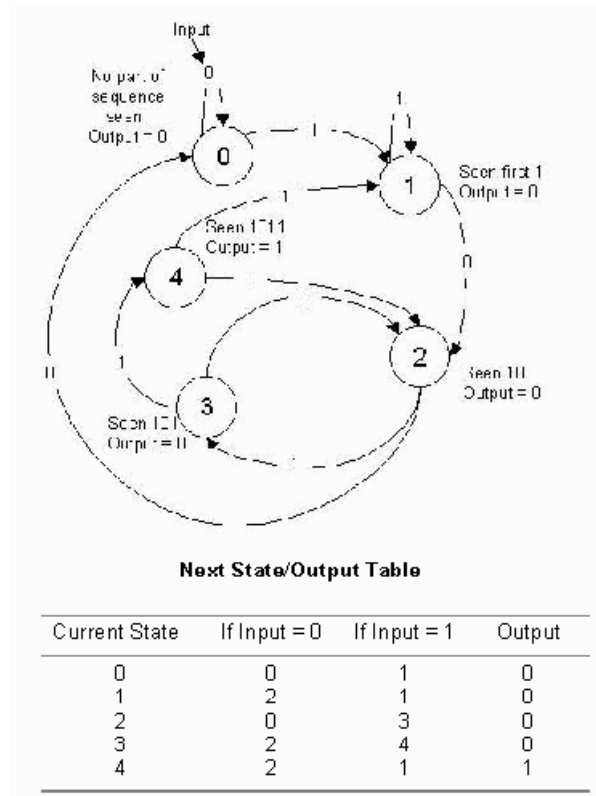

The table lists the next state and output that result from the current state and input. For example, if the current state is 4, the output is 1 indicating the detection of the desired sequence, and if the input is 1 the next state is state 1.

The Registered Moore State Machine block is configured with next state matrix and output array obtained from the next state/output table discussed above. They are constructed as follows:

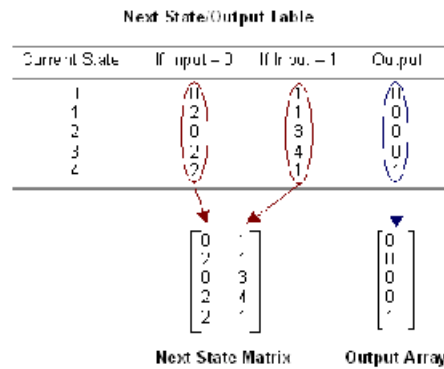

The rows of the matrices correspond to the current state. The next state matrix has one column for each input value. The output array has only one column since the input value does not affect the output of the state machine.

## Block Parameters

The block parameters dialog box can be invoked by double-clicking the icon in your Simulink model.

The next state logic and state register in this block are implemented with high speed dedicated block RAM. The output logic is implemented using a distributed RAM configured as a lookup table, and therefore has zero latency.

The number of bits used to implement a Moore state machine is given by the equations:

$$d_s = (2^k)(2^i) = 2^{k+i}$$

$$w_s = k$$

$$N_s = d_s * w_s = (k)(2^{k+i})$$

where

$N_s$  = total number of next state logic block RAM bits

$s$  = number of states

$k$  =  $\text{ceil}(\log_2(s))$

$i$  = number of input bits

$d_s$  = depth of state logic block RAM

$w_s$  = width of state logic block RAM

The following table gives examples of block RAM sizes necessary for various state machines:

Number of States	Number of Input Bits	Block RAM Bits Needed
2	5	64
4	1	8
8	6	1536
16	5	2048
32	4	2560
52	1	768
100	4	14336

The block RAM width and depth limitations are described in the core datasheet for the Single Port Block Memory.

## Multipath Fading Channel Model

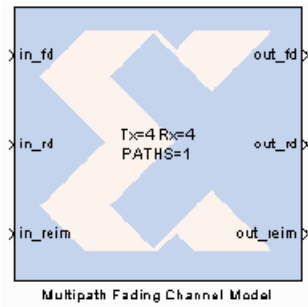

The Multipath Fading Channel Model block implements a model of a fading communication channel. The model supports both Single Input/Single Output (SISO) and Multiple Input/Multiple Output (MIMO) channels. The model provides functionality similar to the Simulink 'Multipath Rayleigh Fading Channel' block in a hardware realizable form. This enables high speed hardware co-simulation of entire communication links.

### Theory

The block implements the *Kronecker model*. This model is suitable for systems with antenna arrays not exceeding four elements. The primary model parameters are:

- MT: The number of antennas in the transmit array. For SISO systems this is 1.
- MR: The number of antennas in the receive array. For SISO systems this is 1.
- N; The number of discrete paths between the arrays. For frequency flat channels this is 1.

The model can be represented by the discrete time equation:

$$y(nT) = \sum_{k=1}^N g_k H_k(nT) x(nT - d_k)$$

Where:

- $x(\cdot)$ : Transmit symbol column vector (MT complex elements, time varying).
- T: Sample interval.
- n: Sample index.
- $d_k$ : Delay for path k.
- $H_k(\cdot)$ : Channel coefficient matrix (MR×MT complex elements, time varying).
- $g_k$ : Gain for path k.
- $y(\cdot)$ : Receive symbol column vector (MR complex elements, time varying).

The channel coefficient matrix can be further defined in terms of the spatial covariance matrices of the antenna arrays:

$$H_k(nT) = R_{T,k}^{1/2} H_{U,k}(nT) R_{R,k}^{1/2}$$

Where:

- $R_{T,k}$ : Transmit array spatial covariance matrix for path k.
- $H_{U,k}(\cdot)$ : Uncorrelated channel coefficient matrix for path k ( $M_R \times M_T$  elements, time varying).
- $R_{R,k}$ : Receive array spatial covariance matrix for path k.

## Implementation

The above equations can be rephrased as sparse matrix operations. This allows the elimination of the path summation. The model can then be implemented as follows:

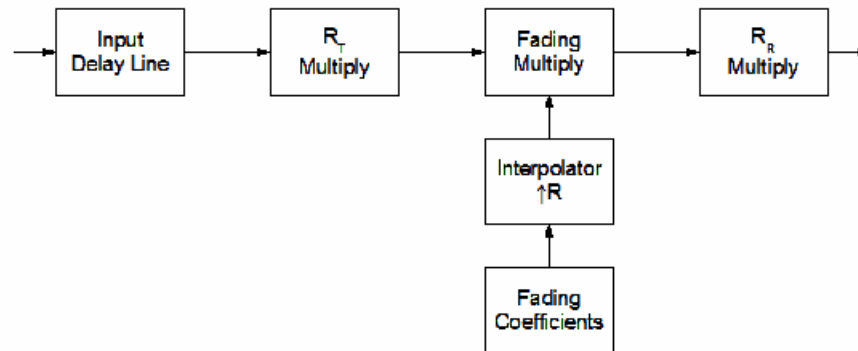

## Block Parameters

The block parameters dialog box can be invoked by double-clicking the icon in your Simulink model.

### Paths tab

Parameters specific to the Paths tab are as follows:

- **Path Delay Vector:** Specify the delay spread for each path in the model. Each element represents the number of samples to delay the path by. The value must be an N element vector.
- **Path Gain Vector:** Specify the gain for each path in the model. Each element represents the linear gain of the path. The value must be an N element vector

### Covariance tab

To support frequency selective channels ( $N > 1$ ), these parameters can be specified as three dimensional arrays. The first two dimensions specify the square covariance matrix, the third specifies the path. If a two dimensional array is specified for a frequency selective channel, it is automatically replicated to produce a three dimensional array. The third dimension is optional for frequency flat ( $N = 1$ ) channels.

- **Transmit Array Spatial Covariance Matrices:** Specify the transmit antenna array covariance matrix for each path. The value can be a  $M_T \times M_T$  matrix, or a  $M_T \times M_T \times N$  array.
- **Receive Array Spatial Covariance Matrices:** Specify the receive antenna array covariance matrix for each path. The value can be a  $M_R \times M_R$  matrix, or a  $M_R \times M_R \times N$  array.

### Fading tab

- **Spectrum Data:** Specify the fading phase and frequency response of each physical path. The number of physical paths is the product of the number of discrete paths (N), and the number of paths between each element of the transmit and receive antenna arrays ( $M_T \times M_R$ ). Spectrum data must be a multidimensional structure with dimensions  $M_R \times M_T \times N$ .

- **Rate:** Specify the interpolation rate from maximum Doppler frequency ( $F_{DMAX}$ ) to channel sample frequency ( $FS$ ). It can be determined as follows:

$$R = \left\lfloor \frac{FS}{(256 \cdot F_{DMAX})} \right\rfloor$$

### Internal tab

- **Datapath Width in Bits:** Specify the width in bits of all internal datapaths.
- **Transmit Multiply Binary Point:** Specify the binary point position at the output of the RT multiply block.
- **Fading Multiply Binary Point:** Specify the binary point position at the output of the fading multiply block.
- **Receive Multiply Binary Point:** Specify the binary point position at the output of the RR multiply block.
- **Covariance Matrix Binary Point:** Specify the binary point position of the covariance matrix coefficients.
- **Random Seed:** Specify the 61-bit (16 hexadecimal digits) seed of the phase noise random number generator.

## Functions

The model includes two MATLAB functions to simplify parameter generation.

### create\_r\_la

The 'create\_r\_la(M,P,phi0,d,lambda,AS)' function generates a covariance matrix from steering vectors as described in [Reference \[1\]](#) at the end of this block description.

- **M:** Specify the number of antennas in the array (transmit or receive).
- **P:** Specify the number of random paths to integrate over to generate the matrix (a value of 50000 gives good results).
- **phi0:** Specify the mean angle of departure (for transmit arrays) or arrival (for receive arrays). Value is in radians.
- **d:** Specify antenna spacing as a vector of antenna positions along a baseline. If this value is specified as a scalar value, the function assumes a uniform linear array (ULA) with the elements evenly distributed about the baseline origin.
- **lambda:** Specify the wavelength, in meters.
- **AS:** Specify the angular spread around the mean angle in radians.

For example, to create a matrix for a 3 element ULA with element spacing of  $\lambda/2$  at 2GHz with an angular spread of 15°:

```
lambda=2.0e9/2.99e8;
create_r_la(3,50000,0,lambda/2,lambda,15*(2*pi/360))
```

### calc\_path\_data

The 'calc\_path\_data(spec\_type,spec\_fd)' function generates spectrum data for a model.

- **spec\_type:** Specify the spectrum type for each physical path in the model. This value must be a multidimensional array with dimensions MR×MT×N. Each element specifies the spectrum type for the physical path.
- **spec\_fd:** Specify the spectrum Doppler frequency for each physical path, normalized to the maximum Doppler frequency (FDMAX). This value can be a multidimensional array with dimensions MR×MT×N or scalar, in which case the value is applied to all physical paths. If omitted a value of unity is assumed.

The value of each spectrum type element specifies the spectrum shape to use for that physical path. Four spectrum types are supported.

- **Type 0:** Specify a null physical path. The path coefficients are zero, and the path exhibits no transmission.
- **Type 1:** Specify an impulse physical path. An impulse path has a single impulse in its spectrum. They can be used to represent the line-of-sight (LOS) paths in a channel model (such as required by Rician channels).
- **Type 2:** Specify a classic spectrum physical path. The classic spectrum is also known as the Jakes or Clarke spectrum. It is used to model wireless links with mobile stations [2] [3] [4] and is defined as:

$$S(f) \propto \frac{1}{\sqrt{1 - \left(\frac{f}{f_d}\right)^2}} \quad |f| \leq f_d$$

$$S(f) = 0 \quad \text{elsewhere}$$

- **Type 3:** Specify a rounded spectrum physical path. The rounded spectrum is used to model wireless links with fixed stations [5] and is defined as:

$$S(f) \propto 1 - 1.72 \left(\frac{f}{f_d}\right)^2 + 0.785 \left(\frac{f}{f_d}\right)^4 \quad |f| \leq f_d$$

$$S(f) = 0 \quad \text{elsewhere}$$

Once generated, each spectrum is normalized to unity power.

For example, to create and plot spectrum data for a  $M_T=4$ ,  $M_R=3$  and  $N=2$  channel, where the two paths combine to give Rician fading (for example, impulse and classic). We assume that the mobile station (MS) is receding from the base station (BS) at  $0.707 \times v_{MS}$  (giving  $f_d=0.707$  for the LOS physical paths):

```
Mt=4; Mr=3; N=2;
spec_type=cat(3, ones(Mr, Mt)*1, ones(Mr, Mt)*2);
spec_fd =cat(3, ones(Mr, Mt)*0.707, ones(Mr, Mt)*1);
spec_data=calc_path_data(spec_type, spec_fd);
plot([spec_data.spectrum]);
```

## Data Format

Internally the model uses a three signal interface for transferring complex vector quantities between blocks. This interface allows matrix/vector operations to be chained together. Vectors are transferred as streams of interleaved real and imaginary samples tagged with frame and repetition handshaking signals. This interface allows vectors to be repeated multiple times per frame. This feature can be used to simplify matrix-vector multiplies, where the vector values are required repeatedly, once per matrix row.

The three signal interface is as follows:



- **reim**: Stream of interleaved real and imaginary (I and Q) samples for each vector. Potentially each vector is transferred multiple times, as indicated by the rd signal.
- **fd**: Indicates the start of each vector frame.
- **rd**: Indicates the start of each vector repetition.

The diagram below shows how a 3-element vector would be represented before multiplication by a 3x3 matrix. The vector is repeated 3 times (once for each matrix row) greatly simplifying the multiplication logic.

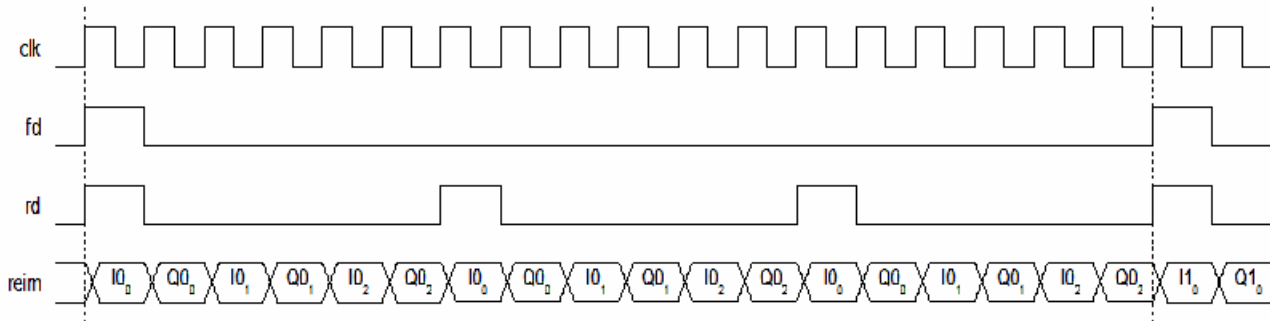

### Input

Input data is presented on the in\_fd, in\_rd, and in\_reim ports. Vector repetition is not required at the input, hence the in\_rd signal is ignored, and only the first  $2 \times MT$  samples are used. For example, for a  $MT=2$  channel:

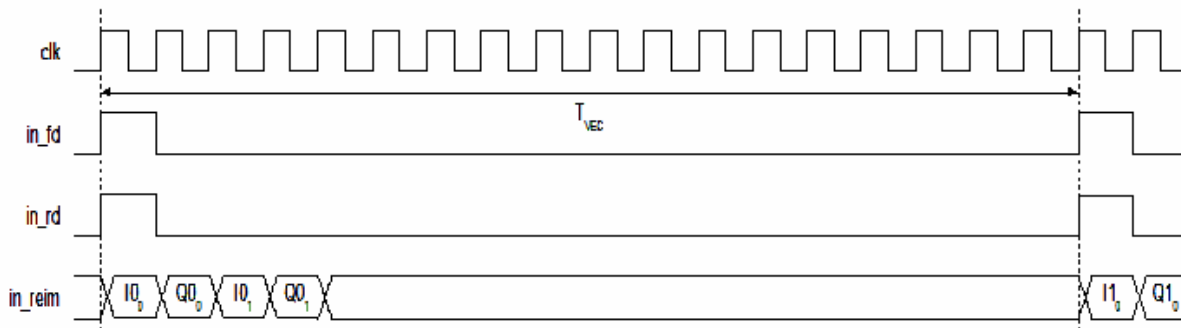

## Output

Output data is presented on the out\_fd, out\_rd, and out\_reim ports. The data is repeated throughout the frame. For example, for a MR=3 channel.:

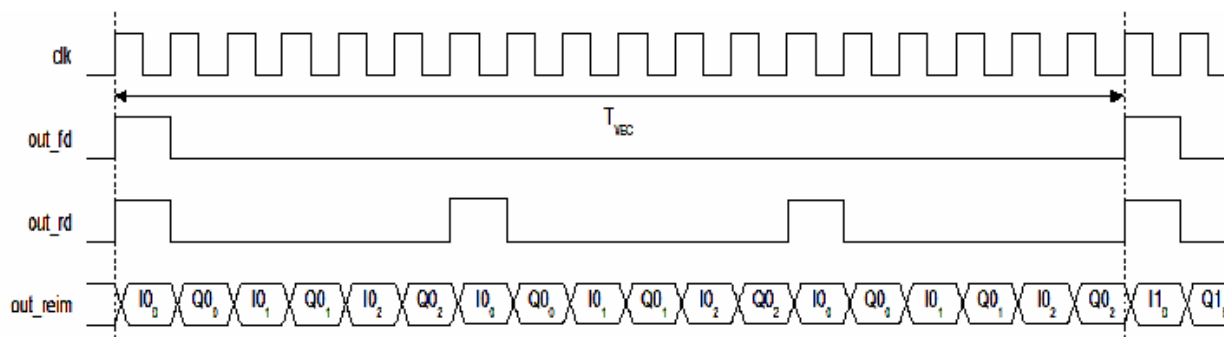

## Timing

The number of samples between successive fd pulses (T<sub>VEC</sub>), must be sufficient for the internal blocks to process the data. The number of cycles required by each block is a function of the MT, MR, N, and RATE parameters as follows:

RT Multiply: Requires  $2 \times MT \times MT \times N$  cycles

Fading Multiply: Requires  $2 \times MT \times MR \times N \times \text{ceil}(64/\text{RATE})$  cycles

RR Multiply: Requires  $2 \times MR \times MR \times N$  cycles

Hence, the minimum value of T<sub>VEC</sub> is:

$$T_{VEC} = 2N \max(\max(M_T, M_R)^2, M_T M_R \lceil 64 / (\text{RATE}) \rceil)$$

The model will produce an error during simulation if this constraint is not met.

## Initialization

The model requires approximate  $3 \times R$  input frames for the fading coefficient generator to initialize. During this period the channel coefficients, and consequentially the output data, is zero.

## Demonstrations

Two demonstrations are included that show how the model can be used. Each includes notes on how parameters can be calculated.

- SISO Channel Model : A demo showing a SISO channel based on 3GPP TS 25.104, Annex B.2, Case 4.
- MIMO Channel Model : A demo showing a frequency flat MIMO channel.

## Hardware Co-Simulation Example

An example of how to use the model for hardware co-simulation is included in the `<ISE_Design_Suite_tree>/sysgen/examples/mfcm_hwcosim` directory. The directory contains three files:

- mfc\_m\_hw.mdl : Model specifying the hardware component of the co-simulation design. Design consists of a shared memory for data input, a channel model, and a shared memory for data output.
- mfc\_m\_hw\_cw.bit: The 'mfc\_m\_hw.mdl' design compiled for the XtremeDSP kit.
- mfc\_m\_cosim.mdl : Model specifying the software component of the co-simulation. The shared memory blocks are used to pass packets of data to the hardware for processing, and to receive packets of processed data. By default this design will use the pre-generated 'mfc\_m\_hw\_cw.bit' – this will have to be regenerated for different hardware targets.

## Reference

1. A. Forenza and R.W. Heath Jr. *Impact of Antenna Geometry on MIMO Communication in Indoor Clustered Channels*, Wireless Networking and Communications Group, ECE Department, The University of Texas at Austin.
2. 3GPP TS 25.101 V6.7.0 (2005-03) *Annex B, User Equipment (UE) radio transmission and reception (FDD)*, Technical Specification Group Radio Access Network, 3rd Generation Partnership Project.
3. 3GPP TS 25.104 V6.8.0 (2004-12) *Annex B, Base Station (BS) radio transmission and reception (FDD)*, Technical Specification Group Radio Access Network, 3rd Generation Partnership Project.
4. 3GPP TR 25.943 V6.0.0 (2004-12), *Deployment aspects*, Technical Specification Group Radio Access Network, 3rd Generation Partnership Project.
5. IEEE 802.16.3c-01/29r4 (2001-07-16) *Channel Models for Fixed Wireless Applications*, IEEE 802.16 Broadband Wireless Access Working Group.

## n-tap Dual Port Memory MAC FIR Filter

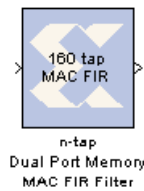

The Xilinx n-tap Dual Port Block RAM MAC FIR Filter reference block implements a multiply-accumulate-based FIR filter. One dedicated multiplier and one dual port block RAM are used in the filter. The filter configuration illustrates a technique for storing coefficients and data samples in filter design. The Virtex FPGA family (and Virtex family derivatives) provide dedicated circuitry for building fast, compact adders, multipliers, and flexible memory architectures. The filter design takes advantage of these silicon features by implementing a design that is compact and resource efficient.

Implementation details are provided in the filter design subsystems. To read the annotations, place the block in a model, then right-click on the block and select **Explore** from the popup menu. Double click on one of the sub-blocks to open the sub-block model and read the annotations.

### Block Parameters

The block parameters dialog box can be invoked by double-clicking the icon in your Simulink model.

Parameters specific to this reference block are as follows:

- **Data Input Bit Width:** Width of input sample.
- **Data Input Binary Point:** Binary point location of input.
- **Coefficients:** Specify coefficients for the filter. Number of taps is inferred from size of coefficient vector.
- **Number of Bits per Coefficient:** Bit width of each coefficient.
- **Binary Point per Coefficient:** Binary point location for each coefficient.
- **Sample Period:** Sample period of input.

### Reference

- J. Hwang and J. Ballagh. *Building Custom FIR Filters Using System Generator*. 12th International Field-Programmable Logic and Applications Conference (FPL). Montpellier, France, September 2002. Lecture Notes in Computer Science 2438

## n-tap MAC FIR Filter

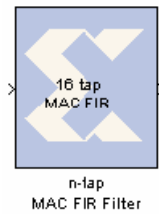

The Xilinx n-tap MAC FIR Filter reference block implements a multiply-accumulate-based FIR filter. The three filter configurations help illustrate the trade-offs between filter throughput and device resource consumption. The Virtex FPGA family (and Virtex family derivatives) provide dedicated circuitry for building fast, compact adders, multipliers, and flexible memory architectures. Each filter design takes advantage of these silicon features by implementing a design that is compact and resource efficient.

Implementation details are provided in the filter design subsystems. To read the annotations, place the block in a model, then right-click on the block and select **Explore** from the popup menu. Double click on one of the sub-blocks to open the sub-block model and read the annotations.

### Block Parameters

The block parameters dialog box can be invoked by double-clicking the icon in your Simulink model.

Parameters specific to this reference block are as follows:

- **Coefficients:** Specify coefficients for the filter. Number of taps is inferred from size of coefficient vector.
- **Number of Bits per Coefficient:** Bit width of each coefficient.
- **Binary Point for Coefficient:** Binary point location for each coefficient.
- **Number of Bits per Input Sample:** Width of input sample.
- **Binary Point for Input Samples:** Binary point location of input.
- **Input Sample Period:** Sample period of input.

### Reference

[1] J. Hwang and J. Ballagh. *Building Custom FIR Filters Using System Generator*. 12th International Field-Programmable Logic and Applications Conference (FPL). Montpellier, France, September 2002. Lecture Notes in Computer Science 2438

## Registered Mealy State Machine

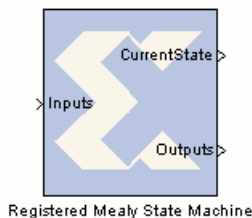

A "Mealy machine" is a finite state machine whose output is a function of state transition, for example, a function of the machine's current state and current input. A "registered Mealy machine" is one having registered output, and can be described with the following block diagram:

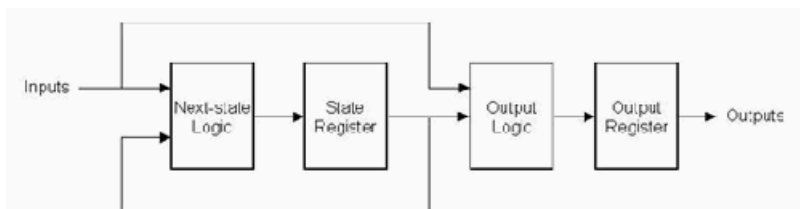

There are many ways to implement such state machines in System Generator (e.g., using the MCode block to implement the transition function, and registers to implement state variables). This reference block provides a method for implementing a Mealy machine using block and distributed memory. The implementation is very fast and efficient. For example, a state machine with 8 states, 1 input, and 2 outputs that are registered can be realized with a single block RAM that runs at more than 150 MHz in a Xilinx Virtex device.

The transition function and output mapping are each represented as an  $N \times M$  matrix, where  $N$  is the number of states, and  $M$  is the size of the input alphabet (e.g.,  $M = 2$  for a binary input). It is convenient to number rows and columns from 0 to  $N - 1$  and 0 to  $M - 1$  respectively. Each state is represented as an unsigned integer from 0 to  $N - 1$ , and each alphabet character is represented as an unsigned integer from 0 to  $M - 1$ . The row index of each matrix represents the current state, and the column index represents the input character

For the purpose of discussion, let  $F$  be the  $N \times M$  transition function matrix, and  $O$  be the  $N \times M$  output function matrix. Then  $F(i,j)$  is the next state when the current state is  $i$  and the current input character is  $j$ , and  $O(i,j)$  is the corresponding output of the Mealy machine.

### Example

Consider the problem of designing a Mealy machine to recognize the pattern '1011' in a serial stream of bits. The state transition diagram and equivalent transition table are shown below.

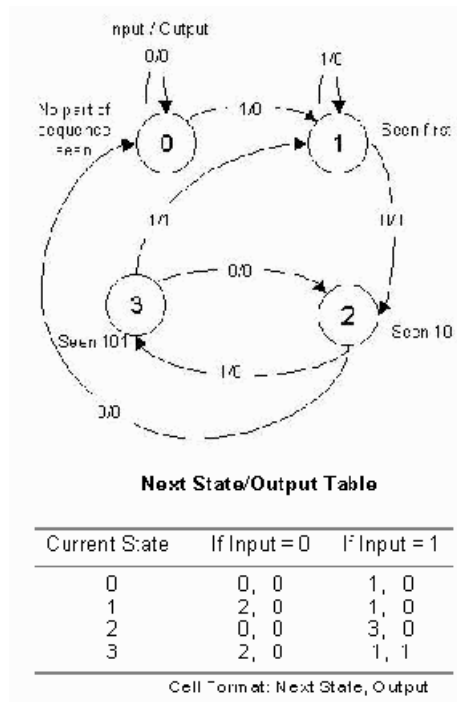

The table lists the next state and output that result from the current state and input. For instance, if the current state is 3 and the input is 1, the next state is 1 and the output is 1, indicating the detection of the desired sequence.

The Registered Mealy State Machine block is configured with next state and output matrices obtained from the next state/output table discussed above. These matrices are constructed as shown below:

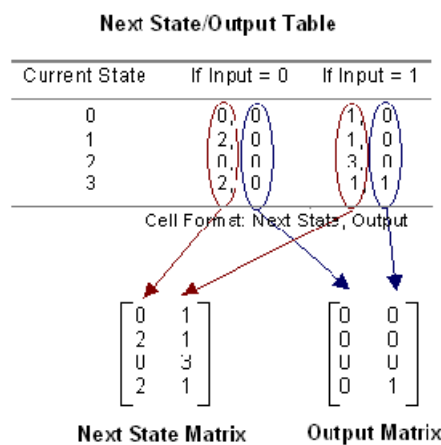

Rows of the matrices correspond to states, and columns correspond to input values.

## Block Parameters

The block parameters dialog box can be invoked by double-clicking the icon in your Simulink model.

The next state logic, state register, output logic, and output register are implemented using high speed dedicated block RAM. Of the four blocks in the state machine library, this is the fastest and most area efficient. However, the output is registered and thus the input does not affect the output instantaneously.

The number of bits used to implement a Mealy state machine is given by the equations:

$$depth = (2^k)(2^i) = 2^{k+i}$$

$$width = k+o$$

$$N = depth * width = (k+o)(2^{k+i})$$

where

N = total number of block RAM bits

s = number of states

k = ceil(log2(s))

i = number of input bits

o = number of output bits

The following table gives examples of block RAM sizes necessary for various state machines:

Number of States	Number of Input Bits	Number of Output Bits	Block RAM Bits Needed
2	5	10	704
4	1	2	32
8	6	7	5120
16	5	4	4096
32	4	3	4096
52	1	11	2176
100	4	5	24576



# Registered Moore State Machine

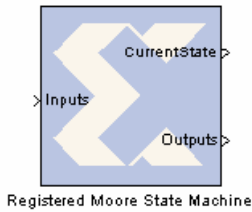

A "Moore machine" is a finite state machine whose output is only a function of the machine's current state. A "registered Moore machine" is one having registered output, and can be described with the following block diagram:

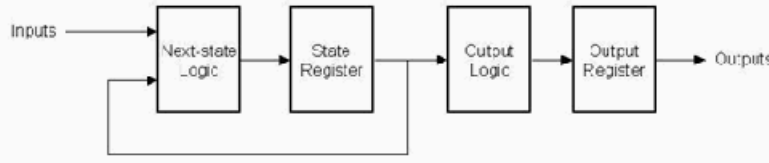

There are many ways to implement such state machines in System Generator, e.g., using the Mcode block. This reference block provides a method for implementing a Moore machine using block and distributed memory. The implementation is very fast and efficient. For example, a state machine with 8 states, 1 input, and 2 outputs that are registered can be realized with a single block RAM that runs at more than 150 MHz in a Xilinx Virtex device.

The transition function and output mapping are each represented as an  $N \times M$  matrix, where  $N$  is the number of states, and  $M$  is the size of the input alphabet (e.g.,  $M = 2$  for a binary input). It is convenient to number rows and columns from 0 to  $N - 1$  and 0 to  $M - 1$  respectively. Each state is represented as an unsigned integer from 0 to  $N - 1$ , and each alphabet character is represented as an unsigned integer from 0 to  $M - 1$ . The row index of each matrix represents the current state, and the column index represents the input character.

For the purpose of discussion, let  $F$  be the  $N \times M$  transition function matrix, and  $O$  be the  $N \times M$  output function matrix. Then  $F(i,j)$  is the next state when the current state is  $i$  and the current input character is  $j$ , and  $O(i,j)$  is the corresponding output of the Mealy machine.

## Example

Consider the problem of designing a Moore machine to recognize the pattern '1011' in a serial stream of bits. The state transition diagram and equivalent transition table are shown below.

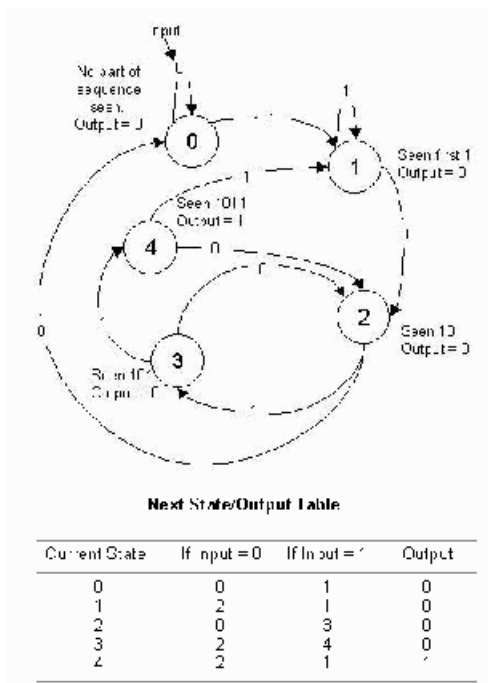

The table lists the next state and output that result from the current state and input. For example, if the current state is 4, the output is 1 indicating the detection of the desired sequence, and if the input is 1 the next state is state 1.

The Registered Moore State Machine block is configured with next state matrix and output array obtained from the next state/output table discussed above. They are constructed as shown below:

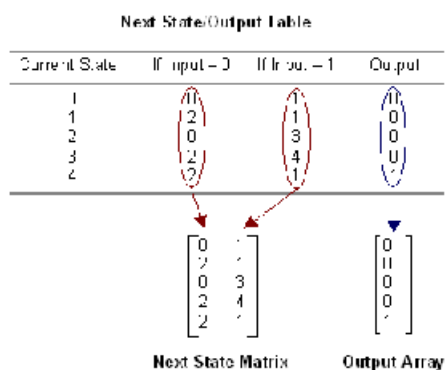

The rows of the matrices correspond to the current state. The next state matrix has one column for each input value. The output array has only one column since the input value does not affect the output of the state machine.

## Block Parameters

The block parameters dialog box can be invoked by double-clicking the icon in your Simulink model.

The next state logic and state register in this block are implemented with high speed dedicated block RAM.

The number of bits used to implement a Moore state machine is given by the equations:

$$d_s = (2^k)(2^i) = 2^{k+i}$$

$$w_s = k$$

$$N_s = d_s * w_s = (k)(2^{k+i})$$

where

$N_s$  = total number of next state logic block RAM bits

$s$  = number of states

$k$  =  $\text{ceil}(\log_2(s))$

$i$  = number of input bits

$d_s$  = depth of state logic block RAM

$w_s$  = width of state logic block RAM

The following table gives examples of block RAM sizes necessary for various state machines:

Number of States	Number of Input Bits	Block RAM Bits Needed
2	5	64
4	1	8
8	6	1536
16	5	2048
32	4	2560
52	1	768
100	4	14336

The block RAM width and depth limitations are described in the core datasheet for the Single Port Block Memory.

## Virtex Line Buffer

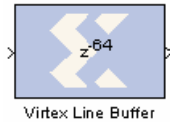

The Xilinx Virtex Line Buffer reference block delays a sequential stream of pixels by the specified buffer depth.

### Block Parameters

The block parameters dialog box can be invoked by double-clicking the icon in your Simulink model.

Parameters specific to this reference block are as follows:

- **Buffer Depth:** Number of samples the stream of pixels is delayed.
- **Sample Period:** Sample rate at which the block will run

## Virtex2 Line Buffer

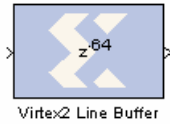

The Xilinx Virtex2 Line Buffer reference block delays a sequential stream of pixels by the specified buffer depth. It is optimized for the Virtex2 family since it uses the Read Before Write option on the underlying Single Port RAM block

### Block Parameters

The block parameters dialog box can be invoked by double-clicking the icon in your Simulink model.

Parameters specific to this reference block are as follows:

- **Buffer Depth:** Number of samples the stream of pixels is delayed.
- **Sample Period:** Sample rate at which the block will run.

## Virtex2 5 Line Buffer

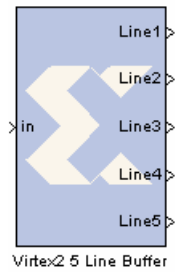

The Xilinx Virtex2 5 Line Buffer reference block buffers a sequential stream of pixels to construct 5 lines of output. Each line is delayed by  $N$  samples, where  $N$  is the length of the line. Line 1 is delayed  $4*N$  samples, each of the following lines are delay by  $N$  fewer samples, and line 5 is a copy of the input.

This block uses Virtex2 Line Buffer block which is located in the Imaging library of the Xilinx Reference Blockset.

### Block Parameters

The block parameters dialog box can be invoked by double-clicking the icon in your Simulink model.

Parameters specific to this reference block are as follows:

- **Line Size:** Number of samples each line is delayed.
- **Sample Period:** Sample rate at which the block will run.

# White Gaussian Noise Generator



The Xilinx White Gaussian Noise Generator (WGNG) generates white Gaussian noise using a combination of the Box-Muller algorithm and the Central Limit Theorem following the general approach described in [1] (reference listed below).

The Box-Muller algorithm generates a unit normal random variable using a transformation of two independent random variables that are uniformly distributed over [0,1]. This is accomplished by storing Box-Muller function values in ROMs and addressing them with uniform random variables.

The uniform random variables are produced by multiple-bit leap-forward LFSRs. A standard LFSR generates one output per clock cycle. K-bit leap-forward LFSRs are able to generate k outputs in a single cycle. For example, a 4-bit leap-forward LFSR outputs a discrete uniform random variable between 0 and 15. A portion of the 48-bit block parameter seed initializes each LFSR allowing customization. The outputs of four parallel Box-Muller subsystems are averaged to obtain a probability density function (PDF) that is Gaussian to within 0.2% out to 4.8sigma. The overall latency of the WGNG is 10 clock cycles. The output port noise is a 12 bit signed number with 7 bits after the binary point.

## 4-bit Leap-Forward LFSR

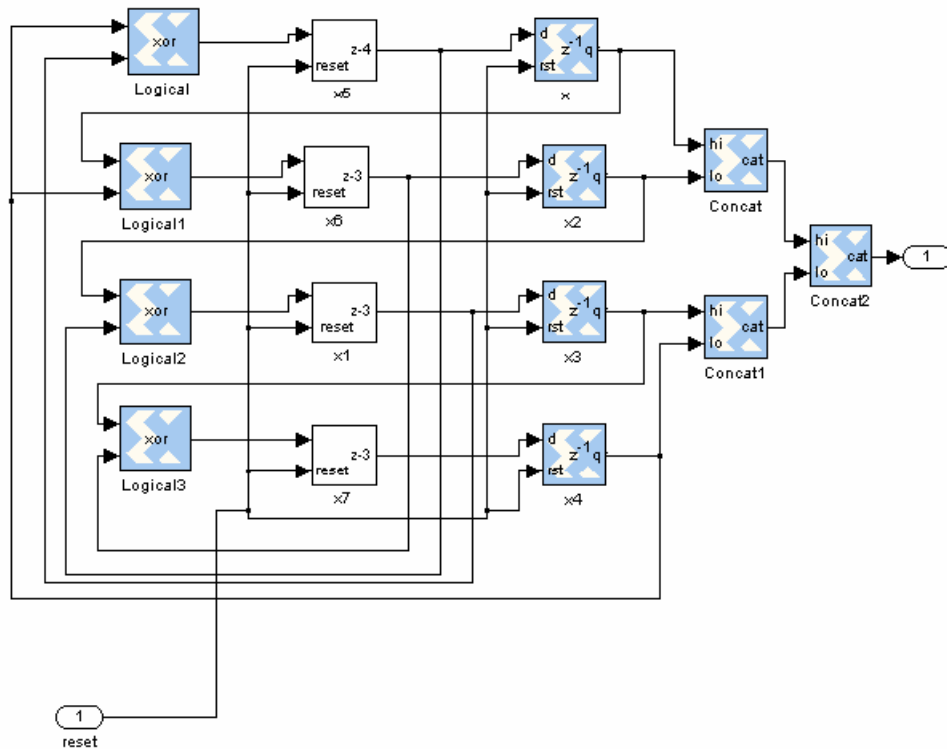

## Box-Muller Method

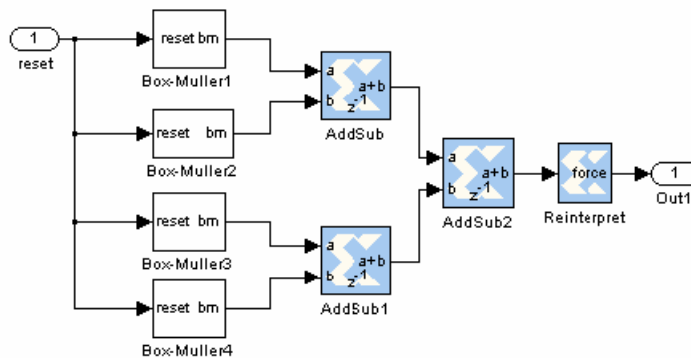

## Block Parameters

The block parameters dialog box can be invoked by double-clicking the icon in your Simulink model.

The block parameter is a decimal starting seed value.

## Reference

A. Ghazel, E. Boutillon, J. L. Danger, G. Gulak and H. Laamari, *Design and Performance Analysis of a High Speed AWGN Communication Channel Emulator*, IEEE PACRIM Conference, Victoria, B. C., Aug. 2001.



## *Xilinx XtremeDSP Kit Blockset*

---

Blocks related to the XtremeDSP Kit include the following:

Library	Description
<a href="#">XtremeDSP Analog to Digital Converter</a>	Allows System Generator components to connect to the two analog input channels on the Nallatech BenAdda board when a model is prepared for hardware co-simulation
<a href="#">XtremeDSP Co-Simulation</a>	Can be used in place of a Simulink subsystem that was compiled for XtremeDSP co-simulation.
<a href="#">XtremeDSP Digital to Analog Converter</a>	Allows System Generator components to connect to the two analog output channels on the Nallatech BenAdda board when a model is prepared for hardware co-simulation.
<a href="#">XtremeDSP External RAM</a>	Allows System Generator components to connect to the external 256K x 16 ZBT SRAM on the Nallatech BenAdda board when a model is prepared for hardware co-simulation.
<a href="#">XtremeDSP LED Flasher</a>	Allows System Generator models to use the tri-color LEDs on the BenADDA board when a model is prepared for co-simulation.

## XtremeDSP Analog to Digital Converter



The Xilinx XtremeDSP ADC block allows System Generator components to connect to the two analog input channels on the Nallatech BenAdda board when a model is prepared for hardware co-simulation. Separate ADC blocks, ADC1 and ADC2 are provided for analog input channels one and two, respectively.

In Simulink, the ADC block is modeled using an input gateway that drives a register. The ADC block accepts a double signal as input and produces a signed 14-bit Xilinx fixed-point signal as output. The output signal uses 13 fractional bits.

In hardware, a component that is driven by the ADC block output is driven by one of the two 14-bit AD6644 analog to digital converter devices on the BenAdda board. When a System Generator model that uses an ADC block is translated into hardware, the ADC block is translated into a top-level input port on the model HDL. The appropriate pin location constraints are added in the BenAdda constraints file, thereby ensuring the port is driven appropriately by the ADC component.

A free running clock should be used when a hardware co-simulation model contains an ADC block. In addition, the programmable clock speed should not be set higher than 64 MHz.

### Block Parameters

The block parameters dialog box can be invoked by double-clicking the icon in your Simulink model.

Parameters specific to the ADC block are:

- **Sample Period:** specifies the sample period for the block.

### Data Sheet

A data sheet for the AD6644 device is provided in the XtremeDSP development kit install directory. If FUSE denotes the directory containing the Nallatech FUSE software, the data sheet can be found in the following location:

FUSE\XtremeDSP Development Kit\Docs\Datasheets\ADC ad6644.pdf

## XtremeDSP Co-Simulation



The Xilinx XtremeDSP Co-simulation block can be used in place of a Simulink subsystem that was compiled for XtremeDSP co-simulation. During simulation, the block behaves exactly as the subsystem from which it originated, except that the simulation data is processed in hardware instead of software.

The port interface of the co-simulation block will vary. When a model is compiled for co-simulation, a new library is created that contains a custom XtremeDSP hardware co-simulation block. This block has input and output ports that match the gateway names (or port names if the subsystem is not the top level) from the original model.

The hardware co-simulation block interacts with the XtremeDSP development kit board during a Simulink simulation. Simulation data that is written to the input ports of the block are passed to the hardware by the block. Conversely, when data is read from the co-simulation block's output ports, the block reads the appropriate values from the hardware and drives them on the output ports so they can be interpreted in Simulink. In addition, the block automatically opens, configures, steps, and closes the development kit board.

### Block Parameters

The block parameters dialog box can be invoked by double-clicking the icon in your Simulink model.

#### Basic tab

Parameters specific to the Basic tab are as follows:

- **Clock source:** You can select between Single stepped and Free running clock sources. Selecting a Single Stepped clock allows the block to step the board one clock cycle at a time. Each clock cycle step corresponds to some duration of time in Simulink. Using this clock source ensures the behavior of the co-simulation hardware during simulation is bit and cycle accurate when compared to the simulation behavior of the subsystem from which it originated. Sometimes single stepping is not necessary and the board can be run with a Free Running clock. In this case, the board will operate asynchronously to the Simulink simulation.
- **Frequency (MHz):** When Free Running clock mode is selected, you can specify the operating frequency that the free running clock should be programmed to run at during simulation. The selected clock frequency is rounded to the nearest valid frequency available from the programmable oscillator. Note: You must take care to specify a frequency that does not exceed the maximum operating frequency of the model's FPGA implementation. The valid operating frequencies of the programmable oscillator are listed below:  
20 MHz; 25 MHz; 30 MHz; 33.33 MHz; 40 MHz; 45 MHz; 50 MHz; 60 MHz; 66.66 MHz; 70 MHz; 75 MHz; 80 MHz; 90 MHz; 100 MHz; 120 MHz.
- **Card number:** Specifies the index of the XtremeDSP development kit card to use for hardware co-simulation. A default value of 1 should be used unless you have multiple XtremeDSP kit boards installed.
- **Bus:** Allows you to choose the interface in which the co-simulation block communicates with the XtremeDSP development kit board during a Simulink simulation. You can select between PCI and USB interfaces.
- **Has combinational path:** Sometimes it is necessary to have a direct combinational feedback path from an output port on a hardware co-simulation block to an input port on the same block (e.g., a wire connecting an output port to an input port on a given block). If you require a direct feedback path from an output to input port, and your design does not include a combinational

path from any input port to any output port, un-checking this box allows the feedback path in the design.

- **Bitstream name:** Specifies the co-simulation FPGA configuration file for the XtremeDSP development kit board. When a new co-simulation block is instantiated during compilation, this parameter is automatically set so that it points to the appropriate configuration file. You need only adjust this parameter if the location of the configuration file changes.

## XtremeDSP Digital to Analog Converter



The Xilinx XtremeDSP DAC block allows System Generator components to connect to the two analog output channels on the Nallatech BenAdda board when a model is prepared for hardware co-simulation. Separate DAC blocks DAC1 and DAC2 are provided for analog output channels one and two respectively.

In Simulink, the DAC block is modeled by a register block that drives an output gateway. All DAC control signals are appropriately wired to constants. The DAC block must be driven by a 14-bit Xilinx fixed-point signal, with the binary point at position 13. The output port of the DAC block produces a signal of type double.

In hardware, a component that drives a DAC block input will drive one of the two 14-bit AD9772A digital to analog converter devices on the BenAdda board. When a System Generator model that uses DAC block is translated into hardware, the DAC block is translated into a top-level output port on the model HDL. The appropriate pin location constraints are added in the BenAdda constraints file, thereby ensuring the output port drives the appropriate DAC pins.

A free running clock should be used when a hardware co-simulation model contains a DAC block. In addition, the programmable clock speed should not be set higher than 64 MHz.

### Block Parameters

The block parameters dialog box can be invoked by double-clicking the icon in your Simulink model.

Parameters specific to the DAC block are:

- **Sample Period:** specifies the sample period for the block.

### Data Sheet

A data sheet for the AD9772A device is provided in the directory to which the XtremeDSP development kit has been installed. If FUSE denotes the directory containing the FUSE software, the data sheet can be found in the following location:

FUSE\XtremeDSP Development Kit\Docs\Datasheets\DAC AD9772A.pdf

## XtremeDSP External RAM



The Xilinx XtremeDSP External RAM block allows System Generator components to connect to the external 256K x 16 ZBT SRAM on the Nallatech BenAdda board when a model is prepared for hardware co-simulation.

The block provides a Simulink simulation model for the memory device. The ports on the block look and behave like ports on a traditional synchronous RAM device. The address port should be driven by an unsigned 18-bit Xilinx fixed-point signal having binary point at position 0. The we port should be driven by a Xilinx Boolean signal. The data port should be driven by a 16-bit Xilinx fixed-point signal. The block drives 16-bit Xilinx fixed-point data values on its output port.

In hardware, components that read from and write to the block in Simulink read from and write to the Micron ZBT SRAM device on the BenAdda board. When a System Generator model that uses an external RAM block is translated into hardware, the ports on the RAM block are translated into top-level input and output ports on the model HDL. The appropriate pin location constraints for these ports are included in the BenAdda constraints file. The ZBT SRAM device uses the same clock as the System Generator portion of the hardware co-simulation implementation.

### Block Parameters

The block parameters dialog box can be invoked by double-clicking the icon in your Simulink model.

Parameters specific to the block are as follows:

- **Output Data Type:** selects the output data type of the RAM. You can choose between unsigned and signed (two's complement) data types.
- **Data Width:** specifies the width of the input data.
- **Data Binary Point:** selects the binary point position of the data values stored as the memory contents. The binary point position must be between 0 and 16 (the data width)

## XtremeDSP LED Flasher



The Xilinx XtremeDSP LED Flasher block allows System Generator models to use the tri-color LEDs on the BenADDA board when a model is prepared for co-simulation. When the model is co-simulated, the LEDs will cycle through red, green and yellow colors. The LEDs are driven by the two most significant bits of a 27-bit free running counter. To see the LEDs cycle through the three colors, you should select a free running clock during model simulation.

### Block Parameters

The block parameters dialog box can be invoked by double-clicking the icon in your Simulink model.





## System Generator Utilities

---

<a href="#">xlAddTerms</a>	Automatically adds sinks and sources to System Generator models.
<a href="#">xlCache</a>	Used to manage the System Generator caches.
<a href="#">xlConfigureSolver</a>	Configures the Simulink solver settings of a model to provide optimal performance during System Generator simulation.
<a href="#">xlfa_denominator</a>	Returns the denominator of the filter object in an FDATool block.
<a href="#">xlfa_numerator</a>	Returns the numerator of the filter object in an FDATool block.
<a href="#">xlGenerateButton</a>	Provides a programmatic way to invoke the System Generator code generator.
<a href="#">xlgetparam and xlsetparam</a>	Used to get and set parameter values in a System Generator block.
<a href="#">xlgetparams</a>	Used to get all parameter values in a System Generator block.
<a href="#">xlGetReloadOrder</a>	The xlGetReloadOrder function obtains the reload order of the FIR Compiler block (versions 5.0 and greater).
<a href="#">xlInstallPlugin</a>	Used to install a System Generator hardware co-simulation plugin.
<a href="#">xlLoadChipScopeData</a>	Loads a chipscope™ data .prn file to the workspace.
<a href="#">xlSBDBuilder</a>	Launches the System Generator Board support Description builder tool.
<a href="#">xlSetNonMemMap</a>	Marks a gateway block as non-memory mapped.
<a href="#">xlSetUseHDL</a>	Sets the 'Use behavioral HDL' option of blocks in a model of a subsystem.
<a href="#">xlSwitchLibrary</a>	Replaces the HDL library references in the target directory with the specified library name.
<a href="#">xlTBUtills</a>	Provides access to several useful procedures available to the Xilinx Toolbar block, such as layout, redrawlines and getselected.

<a href="#">xlAddTerms</a>	Automatically adds sinks and sources to System Generator models.
<a href="#">xlCache</a>	Used to manage the System Generator caches.
<a href="#">xlConfigureSolver</a>	Configures the Simulink solver settings of a model to provide optimal performance during System Generator simulation.
<a href="#">xlfd_denominator</a>	Returns the denominator of the filter object in an FDATool block.
<a href="#">xlfd_numerator</a>	Returns the numerator of the filter object in an FDATool block.
<a href="#">xlGenerateButton</a>	Provides a programmatic way to invoke the System Generator code generator.
<a href="#">xlgetparam and xlsetparam</a>	Used to get and set parameter values in a System Generator block.
<a href="#">xlgetparams</a>	Used to get all parameter values in a System Generator block.
<a href="#">xlGetReloadOrder</a>	The xlGetReloadOrder function obtains the reload order of the FIR Compiler block (versions 5.0 and greater).
<a href="#">xlTimingAnalysis</a>	Launches the System Generator Timing Analyzer with the specified timing data.
<a href="#">xlUpdateModel</a>	Manages System Generator versions.
<a href="#">xlVDMACreateProject</a>	Takes a System Generator design with a VDMA Interface block, and creates an ISE project with a top-level module that stitches the System Generator design with an XPS sub-module that instantiates the actual VDMA, AXI interconnect, and MIG IP.
<a href="#">xlVersion</a>	Displays which versions of System Generator are installed on your computer.

## xlAddTerms

xlAddTerms is similar to the addterms command in Simulink, in that it adds blocks to terminate or drive unconnected ports in a model. With xlAddTerms, output ports are terminated with a Simulink terminator block, and input ports are correctly driven with either a Simulink or System Generator constant block. Additionally System Generator gateway blocks can also be conditionally added.

The optionStruct argument can be configured to instruct xlAddTerms to set a block's property (e.g. set a constant block's value to 5) or to use different source or terminator blocks.

### Syntax

```
xlAddTerms (arg1, optionStruct)
```

### Description

In the following description, 'source block' refers to the block that is used to drive an unconnected port. And 'term block' refers to the block that is used to terminate an unconnected port.

```
xlAddTerms (arg1, optionStruct)
```

xlAddTerms takes either 1 or 2 arguments. The second argument, optionStruct argument is optional. The first argument can be the name of a system, or a block list.

arg1	Description
gcs	A string-handle of the current system
'top/test1'	A string-handle of a system called test1. In this case, xlAddTerms is passed a handle to a system. This will run xlAddTerms on all the blocks under test1, including all children blocks of subsystems.
{ 'top/test1' }	A block list of string handles. In this case, xlAddTerms is passed a handle to a block. This will run xlAddTerms only on the block called test1, and will not process child blocks.
{ 't/b1'; 't/b2'; 't/b3' }	A block list of string handles.
[1;2;3]	A block list of numeric handles.

The optionStruct argument is optional, but when included, should be a MATLAB structure. The following table describes the possible values in the structure. The structure field names (as is true with all MATLAB structure field names) are case sensitive.

optionStruct	Description
Source	<p>xlAddTerms can terminate in-ports using any source block (refer to SourceWith field). The parameters of the source block can be specified using the Source field of the optionStruct by passing the parameters as sub-fields of the Source field. The Source field prompts xlAddTerms to do a series of set_params on the source block. Since it is possible to change the type of the source block, it is left to the user to ensure that the parameters here are relevant to the source block in use.</p> <p>E.g. when a Simulink constant block is used as a Source Block, setting the block's value to 10 can be done with:</p> <pre>Source.value = '10'</pre> <p>And when a System Generator Constant block is used as a Source Block, setting the constant block to have a value of 10 and of type UFIX_32_0 can be done with:</p> <pre>Source.const = '10'; Source.arith_type='Unsigned'; Source.bin_pt=0; Source.n_bits=32;</pre>
SourceWith	<p>The SourceWith field allows the source block to be specified. Default is to use a constant block. SourceWith has two sub-fields which must be specified.</p> <p><b>SourceWithBlock:</b> A string specifying the full path and name of the block to be used. e.g. 'built-in/Constant' or 'xbsIndex_r3/AddSub'.</p> <p><b>SourceWithPort:</b> A string specifying the port number used to connect. E.g. '1' or '3' Specifying '1' instructs xlAddTerms to connect using port 1, etc.</p>
TermWith	<p>The TermWith Field allows the term block to be specified. Default is to use a Simulink terminator block. TermWith has two sub-fields which must be specified.</p> <p><b>TermWithBlock:</b> A string specifying the full path and name of the block to be used. e.g. 'built-in/Terminator' or 'xbsIndex_r3/AddSub'.</p> <p><b>TermWithPort:</b></p> <p>A string specifying the port number used to connect. E.g. '1' or '3'</p> <p>Specifying '1' instructs xlAddTerms to connect using port 1, etc.</p>
UseGatewayIns	<p>Instructs xlAddTerms to insert System Generator gateway ins when required. The existence of the field is used to denote insertion of gateway ins. This field must not be present if gateway ins are not to be used.</p>

optionStruct	Description
GatewayIn	If gateway ins are inserted, their parameters can be set using this field, in a similar way as for Source and Term. For example, <pre>GatewayIn.arith_type='Unsigned'; GatewayIn.n_bits='32' GatewayIn.bin_pt='0'</pre> will set the gateway in to output a ufix_32_0.
UseGatewayOuts	Instructs xlAddTerms to insert System Generator gateway outs when required. The existence of the field is used to denote insertion of gateway outs. This field must not be present if gateway outs are not to be used.
GatewayOut	If gateway outs are inserted, their parameters can be set using this field, in a similar way as for Source and Term. For example, <pre>GatewayOut.arith_type='Unsigned'; GatewayOut.n_bits='32' Gatewayout.bin_pt='0'</pre> will set the gateway out to take an input of ufix_32_0.
RecurseSubSystems	Instructs xlAddTerm to recursively run xlAddTerm under all child subsystems. Expects a scalar number, 1 or 0.

## Examples

**Example 1:** Runs xlAddTerms on the current system, with the default parameters: constant source blocks are used, and gateways are not added. Subsystems are recursively terminated.

```
xlAddTerms(gcs);
```

**Example 2:** runs xlAddTerms on all the blocks in the subsystem tt./mySubsystem.

```
xlAddTerms(find_system('tt./mySubsystem','SearchDepth',1));
```

**Example 3:** runs xlAddTerms on the current system, setting the source block's constant value to 1, using gateway outs and changing the term block to use a Simulink display block.

```
s.Source.const = '10';
s.UseGatewayOuts = 1;
s.TermWith.Block = 'built-in/Display';
s.TermWith.Port = '1';
s.RecurseSubSystem = 1;
xlAddTerms(gcs,s);
```

## Remarks

Note that field names are case sensitive. When using the fields 'Source', 'GatewayIn' and 'GatewayOut', users have to ensure that the parameter names to be set are valid.

## See Also

[Toolbar](#), [xlTBUtils](#)

## xlCache

Used to manage the System Generator caches.

### Syntax

```
[core, sg, usertemp] = xlCache ('getpath')
xlCache ('clearall')
xlCache ('clearcorecache')
xlCache ('cleardiskcache')
xlCache ('cleartargetcache')
xlCache ('clearusertemp')
[maxsize] = xlCache ('getdiskcachesize')
[maxentries] = xlCache ('getdiskcacheentries')
```

### Description

This function is used to manage the System Generator caches. The different forms of the function are described as follows:

```
[core, sg, usertemp] = xlCache ('getpath')
```

Returns the location for the System Generator core cache, disk cache and usertemp directory.

```
xlCache ('clearall')
```

Clears the System Generator core cache, disk cache, the usertemp location, then reloads the compilation target plugin cache from disk.

```
xlCache ('clearcorecache')
```

Clears the core cache. The core cache speeds up execution by storing cores generated from Xilinx Core Generator, then recalls those files when reuse is possible.

```
xlCache ('cleardiskcache')
```

Clears the disk cache. The disk cache speeds up execution by tagging and storing files related to simulation and generation, then recalls those files during subsequent simulation and generation rather than rerunning the time consuming tools used to create those files.

```
xlCache ('cleartargetcache')
```

Rehashes the compilation target plugin cache. The compilation target plugin cache needs to be rehashed when a new compilation target plugin is added, or an existing target is changed.

```
xlCache ('clearusertemp')
```

Clears the contents in the usertemp directory. The usertemp directory is used by System Generator to store temporary files used during simulation or netlisting. They are kept on disk for debugging purposes and can be safely deleted without any impact on performance.

```
[maxsize] = xlCache ('getdiskcachesize')
```

Returns the maximum amount of disk space used by the disk cache. By default, the disk cache uses 500MB of disk space to store files. You should set the `SYSGEN_CACHE_SIZE` environment variable to the size of the cache in megabytes. You should set this number to a higher value when working on several large designs.

[maxentries] = xlCache ('getdiskcacheentries')

Returns the maximum number of entries in the cache. The default is 20,000 entries. To set the size of the cache entry database, you should set the `SYSGEN_CACHE_ENTRIES` environment variable to the desired number of entries. Setting this number too small will adversely affect cache performance. You should set this number to a higher value when working on several large designs.

## See Also

[Configuring the System Generator Cache](#),

## xlConfigureSolver

The xlConfigureSolver function configures the Simulink solver settings of a model to provide optimal performance during System Generator simulation.

### Syntax

```
xlConfigureSolver(<model_handle>);
```

### Description

The xlConfigureSolver function configures the model referred to by <model\_handle>. <model\_handle> can be a string or numeric handle to a Simulink model. Library models are not supported by this function since they have no simulation solver parameters to configure.

For optimal performance during System Generator simulation, the following Simulink simulation configuration parameters are set:

```
'SolverType' = 'Variable-step'  
'Solver' = 'VariableStepDiscrete'  
'SolverMode' = 'SingleTasking'
```

### Examples

To illustrate how the xlConfigureSolver function works, do the following:

1. Open the following MDL file: sysgen/examples/chipscope/chip.mdl
2. Enter the following at the MATLAB command line: gcs  
ans = chip  
this is the Model “string” handle
3. Now enter the following from the MATLAB command line:

```
>> xlConfigureSolver(gcs)  
Set 'SolverType' to 'Variable-step'  
Set 'Solver' to 'VariableStepDiscrete'  
Set 'SolverMode' to 'SingleTasking'  
Set 'SingleTaskRateTransMsg' to 'None'  
Set 'InlineParams' to 'on'
```



## xlfda\_denominator

The xlfda\_denominator function returns the denominator of the filter object stored in the Xilinx FDATool block.

### Syntax

```
[den] = xlfda_denominator(FDATool_name);
```

### Description

Returns the denominator of the filter object stored in the Xilinx FDATool block named FDATool\_name, or throws an error if the named block does not exist. The block name can be local (e.g. 'FDATool'), relative (e.g. '../FDATool'), or absolute (e.g. 'untitled/foo/bar/FDATool').

### See Also

[xlfda\\_numerator](#), [FDATool](#)

## xlfa\_numerator

The `xlfa_numerator` function returns the numerator of the filter object stored in the Xilinx FDATool block.

### Syntax

```
[num] = xlfda_numerator(FDATool_name);
```

### Description

Returns the numerator of the filter object stored in the Xilinx FDATool block named `FDATool_name`, or throws an error if the named block does not exist. The block name can be local (e.g. 'FDATool'), relative (e.g. '../FDATool'), or absolute (e.g. 'untitled/foo/bar/FDATool').

### See Also

[xlfa\\_denominator](#), [FDATool](#)

## xlGenerateButton

The xlGenerateButton function provides a programmatic way to invoke the System Generator code generator.

### Syntax

```
status = xlGenerateButton(sysgenblock)
```

### Description

xlGenerateButton invokes the System Generator code generator and returns a status code. Invoking xlGenerateButton with a System Generator block as an argument is functionally equivalent to opening the System Generator GUI for that token, and clicking on the **Generate** button. The following is list of possible status codes returned by xlGenerateButton.

Status	Description
1	Canceled
2	Simulation running
3	Check param error
4	Compile/generate netlist error
5	Netlister error
6	Post netlister script error
7	Post netlist error
8	Post generation error
9	External view mismatch when importing as a configurable subsystem

### See Also

[xlgetparam](#) and [xlsetparam](#), [xlgetparams](#), [System Generator](#) block

## xlgetparam and xlsetparam

Used to get and set parameter values in the [System Generator](#) token. Both functions are similar to the Simulink `get_param` and `set_param` commands and should be used for the System Generator token instead of the Simulink functions.

### Syntax

```
[value1, value2, ...] = xlgetparam(sysgenblock, param1, param2, ...)  
  
xlsetparam(sysgenblock, param1, value1, param2, value2, ...)
```

### Description

The [System Generator](#) token differs from other blocks in one significant manner; multiple sets of parameters are stored for an instance of a System Generator token. The different sets of parameters stored correspond to different compilation targets available to the System Generator token. The 'compilation' parameter is the switch used to toggle between different compilation targets stored in the System Generator token. In order to get or set parameters associated with a particular compilation type, it is necessary to first use `xlsetparam` to change the 'compilation' parameter to the correct compilation target, before getting or setting further values.

```
[value1, value2, ...] = xlgetparam(sysgenblock, param1, param2, ...)
```

The first input argument of `xlgetparam` should be a handle to the [System Generator](#) block. Subsequent arguments are taken as names of parameters. The output returned is an array that matched the number of input parameters. If a requested parameter does not exist, the returned value of `xlgetparam` is empty. The `xlgetparams` function can be used to get all the parameters for the current compilation target.

```
xlsetparam(sysgenblock, param1, value1, param2, value2, ...)
```

The `xlsetparam` function also takes a handle to a System Generator token as the first argument. Subsequent arguments must be provided in pairs, the first should be the parameter name and the second the parameter value.

### Specifying the Compilation Parameter

The 'compilation' parameter on the System Generator token captures the compilation type chosen; for example 'HDL Netlist' or 'NGC Netlist'. As previously stated, when a compilation type is changed, the System Generator token will remember all the options chosen for that particular compilation type. For example, when 'HDL Netlist' is chosen, the corresponding target directory could be set to 'hdl\_dir', but when 'NGC Netlist' is chosen, the target directory could point to a different location, for example 'ngc\_dir'. Changing the compilation type causes the System Generator token to recall previous options made for that compilation type. If the compilation type is selected for the first time, default values are used to populate the rest of the options on the System Generator Token.

When using `xlsetparam` to set the compilation type of a System Generator token, be aware of the above behaviour, since the order in which parameters are set is important; be careful to first set a block's 'compilation' type before setting any other parameters.

When `xlsetparam` is used to set the 'compilation' parameter, it must be the only parameter that is being set on that command. For example, the form below is not permitted:

```
xlsetparam(sysgenblock, 'compilation', 'HDL Netlist', 'synthesis_tool', 'XST')
```

## Examples

**Example 1:** Changing the synthesis tool used for HDL netlist.

```
xlsetparam(sysgenblock, 'compilation', 'HDL Netlist');  
xlsetparam(sysgenblock, 'synthesis_tool', 'XST')
```

The first `xlsetparam` is used to set the compilation target to 'HDL Netlist'. The second `xlsetparam` is used to change the synthesis tool used to 'XST'.

**Example 2:** Getting family and part information.

```
[fam,part]=xlgetparam(sysgenblock, 'xilinxfamily', 'part')  
fam =  
Virtex2  
part =  
xc2v1000
```

## See Also

[xlGenerateButton](#), [xlgetparams](#)

## xlgetparams

The `xlgetparams` command is used to get all parameter values in a [System Generator](#) token associated with the current compilation type. The `xlgetparams` command can be used in conjunction with the `xlgetparam` and `xlsetparam` commands to change or retrieve a System Generator token's parameters.

### Syntax

```
paramstruct = xlgetparams(sysgenblock_handle);
```

To get the `sysgenblock_handle`, enter `gbc` or `gcbh` at the MATLAB command line.

```
paramstruct = xlgetparams('chip/ System Generator');
paramstruct = xlgetparams(gcb);
paramstruct = xlgetparams(gcbh);
```

### Description

All the parameters available to a [System Generator](#) block can be retrieved using the `xlgetparams` command. For more information regarding the parameters, please refer to the System Generator token documentation.

```
paramstruct = xlgetparams(sysgenblock);
```

The first input argument of `xlgetparams` should be a handle to the System Generator token. The function returns a MATLAB structure that lists the parameter value pairs.

### Examples

To illustrate how the `xlparams` function works, do the following:

1. Open the following MDL file: `sysgen/examples/chipscope/chip.mdl`
2. Select the System Generator token
3. Enter the following at the MATLAB command line: `gcb`  
`ans = chip/ System Generator`  
 this is the System Generator token "string" handle
4. Now enter the following from the MATLAB command line: `gcbh`  
`ans = 4.3431`  
 this is the System Generator token "numeric" handle
5. Now enter the following from the MATLAB command line:  
`xlgetparams(gcb)`  
 the function returns all the parameters associated with the Bitstream compilation type:

```
compilation: 'Bitstream'
compilation_lut: [1x1 struct]
simulink_period: '1'
incr_netlist: 'off'
trim_vbits: 'Everywhere in SubSystem'
dbl_ovrd: 'According to Block Masks'
deprecated_control: 'off'
block_icon_display: 'Default'
xilinxfamily: 'virtex5'
part: 'xc5vsx50t'
speed: '-1'
package: 'ff1136'
synthesis_tool: 'XST'
```

```
directory: './bitstream'  
testbench: 'off'  
sysclk_period: '10'  
core_generation: 'According to Block Masks'  
run_coregen: 'off'  
eval_field: '0'  
clock_loc: 'AH15'  
clock_wrapper: 'Clock Enables'  
dcm_input_clock_period: '100'  
synthesis_language: 'VHDL'  
ce_clr: 0  
preserve_hierarchy: 0  
postgeneration_fcn: 'xlBitstreamPostGeneration'  
settings_fcn: 'xlTopLevelNetlistGUI'
```

The `compilation_lut` parameter is another structure that lists the other compilation types that are stored in this System Generator token. Using `xlsetparam` to set the compilation type allows the parameters associated with that compilation type to be visible to either `xlgetparams` or `xlgetparam`.

## See Also

[xlGenerateButton](#), [xlgetparam](#) and [xlsetparam](#)

## xlGetReloadOrder

The xlGetReloadOrder function obtains the reload order of the FIR Compiler block (versions 5.0 and greater).

### Syntax

```
A = xlGetReloadOrder(block_handle, paramStruct, returnType)
```

### Description

#### block\_handle

FIR Compiler block handle in the design. If a FIR Compiler block is selected, then this function can be invoked as follows:

```
xlGetReloadOrder(gcbh)
```

This is the only mandatory parameter for this function

#### paramStruct

Name value pairs of abstracted parameters. For example, if "Hardware Oversampling Specification" format is set to "Maximum\_Possible" then the reload order returned could be incorrect unless the "hardwareoversamplingrate" is explicitly specified as say 4. e.g >>options = ...

```
struct('ratespecification','Hardware_Oversampling_Rate','hardwareoversamplingrate',4)
```

```
>> xlGetReloadOrder(gcbh, options)
```

This parameter is an optional parameter and the default value is struct()

#### returnType

This specifies the reload order information format. This can either be an 'address\_vector' or 'transform\_matrix'. For example if A is a row vector of coefficients, then coefficients sorted in reload order can be obtained as :

```
reload_order_coefficients = ...
```

```
A(xlGetReloadOrder(gcbh, struct(), 'address_vector'))
```

Here reload\_order\_coefficients specifies the order in which coefficients contained in A should be passed to the FIR Compiler through the reload channel.

Alternatively transform matrix can also be used :

```
reload_order_coefficients = xlGetReloadOrder(gcbh,...  
struct(),'transform_matrix')*A'
```

This is an optional parameter and the default value is 'transform\_matrix'



## Example

To illustrate how the `xlGetReloadOrder` can be used, do the following:

1. Open the model located at the following pathname:  
`<sysgen_path>/examples/demos/sysgenReloadable.mdl`
2. Select the FIR Compiler block.
3. From the MATLAB command line, type `xlGetReloadOrder(gcbh)`,  
The following reload order of coefficients should appear:

```
0 0 1
0 1 0
1 0 0
```

**Note:** Note: the Return type was not specified and it defaulted to `'transform_matrix'`. The specified coefficients are "1 2 3 2 1". Since the filter is inferred as a symmetric filter, only 3 out of 5 coefficients need to be loaded. Then the order should be the 3rd element first, followed by the 2nd, then the 1st, for example, 3 2 1.

4. With the same FIR Compiler settings, change the Return type from `'transform_matrix'` to `'address_vector'` as follows:  
`xlGetReloadOrder(gcbh, struct(), 'address_vector')`,  
The same reload order of coefficients should appear but with a different format:
5. Now, try to change the filter's coefficient structure. Double click on the FIR Compiler block, click on the Implementation tab, select "Non\_Symmetric" for the Coefficient Structure, then Click OK.
6. Verify that the FIR Compiler b is selected and enter the same command from the previous step. Observe the different loading order and numbers of coefficient being loaded:

```
ans =
     3
     2
     1
```

```
ans =
     5
     4
     3
     2
     1
```

**Note:** The specified coefficients are "1 2 3 2 1". Since the filter is now explicitly set to non\_symmetric filter, all 5 coefficients are loaded with the reload order as shown above (5th(1), 4th(2), 3rd(3), 2nd(2), 1st(1))

## See Also

[FIR Compiler 5.0 block](#)

## xlInstallPlugin

This function installs the specified System Generator hardware co-simulation plugin. Once the installer has completed, the new compilation target can be selected from the System Generator token dialog box.

### Syntax

```
xlInstallPlugin('<plugin_name>')
```

### Description

This function accepts one parameter, `plugin`, which contains the name of the plugin file to install. The `plugin` parameter can include path information if desired, and the `.zip` extension is optional.

### Examples

**Example 1:**

```
xlInstallPlugin('plugin.zip')
```

**Example 2:**

```
xlInstallPlugin('plugin')
```

### See Also

[Supporting New Platforms](#), [xlSBDBuilder](#)

## xlLoadChipScopeData

The xlLoadChipScopeData function loads a ChipScope Pro™ .prn file, creates workspace variables and conditionally plots the results.

### Syntax

```
status = xlLoadChipScopeData(filename);  
status = xlLoadChipScopeData(filename, plotResults);  
status = xlLoadChipScopeData(filename, plotResults, captureIndex);
```

### Description

Load the .prn file specified in filename, and plot the results if plotResults is specified and set to true. Returns a status of 0 on success. Only ASCII .prn files are supported.

The captureIndex is an optional parameter that is used in conjunction with the ChipScope repetitive trigger feature. If captureIndex is specified, this function waits until the .prn file with the specified capture index is generated by ChipScope before reading the file content.

**Note:** Only signed and unsigned decimal numbers are supported. Make sure to set the data format to signed or unsigned decimal in ChipScope Analyzer.

### Examples

#### Example 1:

```
xlLoadChipScopeData('SineWave.prn',0);
```

### See Also

[ChipScope](#) block

## xlSBDBuilder

The System Generator Board Description (SBD) Builder application aids the designing of new JTAG hardware co-simulation plugins by providing a graphical user interface that prompts for relevant information about the co-simulation platform.

### Syntax

```
xlSBDBuilder;
```

### Description

After invoking SBDBuilder, the main dialog box will appear as shown below:

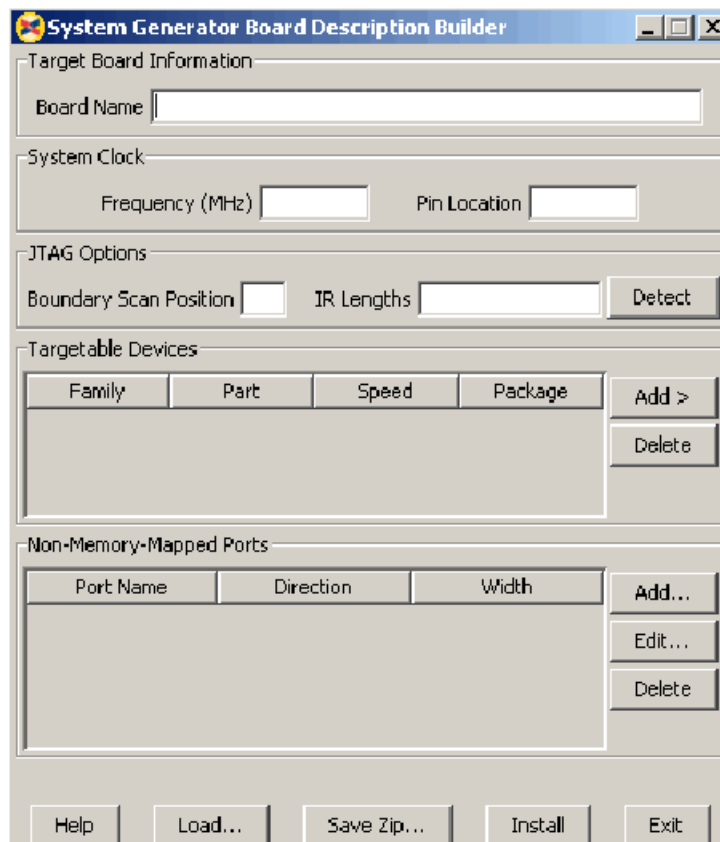

Once the main dialog box is open, you can create a board support package by filling in the required fields described below:

**Board Name:** Tells a descriptive name of the board. This is the name that is listed in System Generator when selecting your JTAG hardware co-simulation platform for compilation.

**System Clock:** JTAG hardware co-simulation requires an on-board clock to drive the System Generator design. The fields described below specify information about the board's system clock:

- **Frequency (MHz):** Specifies the frequency of the on-board system clock in MHz.
- **Pin Location:** Specifies the FPGA input pin to which the system clock is connected.

**JTAG Options:** System Generator needs to know several things about the FPGA board's JTAG chain to be able to program the FPGA for hardware co-simulation. The topic [Obtaining Platform Information](#) describes how and where to find the information required for these fields. If you are unsure of the specifications of your board, please refer to the manufacturer's documentation. The fields specific to JTAG Options are described below:

- **Boundary Scan Position:** Specifies the position of the target FPGA on the JTAG chain. This value should be indexed from 1. (e.g. the first device in the chain has an index of 1, the second device has an index of 2, etc.)
- **IR Lengths:** Specifies the lengths of the instruction registers for all of the devices on the JTAG chain. This list can be delimited by spaces, commas, or semicolons.
- **Detect:** This action attempts to identify the IR Lengths automatically by querying the FPGA board. The board must be powered and connected to a Parallel Cable IV for this to function properly. Any unknown devices on the JTAG chain are represented with a "?" in the list, and must be specified manually.

**Targetable Devices:** This table displays a list of available FPGAs on the board for programming. This is not a description of all of the devices on the JTAG chain, but rather a description of the possible devices that can exist at the aforementioned boundary scan position. For most boards, only one device needs to be specified, but some boards can have alternate, e.g., a choice between an xc1000 or an xc2000 in the same socket. Use the **Add** and **Delete** buttons described below to build the device list:

- **Add:** Brings up a menu to select a new device for the board. As shown in the figure below, devices are organized by family, then part name, then speed, and finally the package type.
- **Delete:** Remove the selected device from the list.

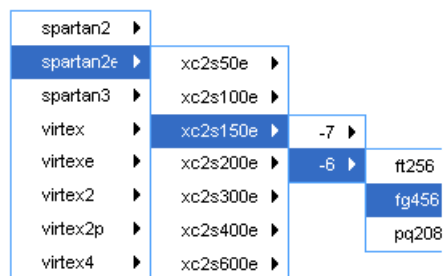

**Non-Memory-Mapped Ports:** You can add support for your own board-specific ports when creating a board support package. Board-specific ports are useful when you have on-board components (e.g., external memories, DACs, or ADCs) that you would like the FPGA to interface to during hardware co-simulation. Board specific ports are also referred to as non-memory-mapped because when the design is compiled for hardware co-simulation, these ports are mapped to their physical locations, rather than creating Simulink ports. See [Specifying Non-Memory Mapped Ports](#) for more information. The **Add**, **Edit**, and **Delete** buttons provide the controls needed for configuring non-memory mapped ports.

- **Add:** Brings up the dialog to enter information about the new port.
- **Edit:** Make changes to the selected port.
- **Delete:** Remove the selected port from the list.

**Help:** Displays this documentation.

**Load:** Fill in the form with values stored in an SBDBuilder Saved Description XML file. This file is automatically saved with every plugin that you create, so it is useful for reloading old plugin files for easy modification.

**Save Zip:** Prompts you for a filename and a target pathname. This will create a zip file with all of the plugin files for System Generator. The zip is in a suitable format for passing to the System Generator [xlInstallPlugin](#) function.

**Exit:** Quit the application.

## See Also

[Supporting New Platforms](#), [xlInstallPlugin](#)

## xlSetNonMemMap

Sets a Gateway In or Gateway Out block to be used as a non memory mapped port when doing hardware co-simulation. This option is often used when a Gateway is intended to be routed to hardware external to the FPGA, instead of being routed to the hardware co-simulation memory map.

### Syntax

```
xlSetNonMemMap(block, company, project)
```

### Description

A call to xlSetNonMemMap must be made with at least three parameters. The first is the name or handle of the gateway that is to be marked as non memory mapped. The marking of a gateway as non memory mapped is predicated upon a company and project name. The second and third parameters are strings that identify the company and project names.

### Examples

#### Example 1:

```
xlSetNonMemMap(gcbh, 'Xilinx', 'jtaghwcosim');
```

The first parameter in the example returns the handle of the block that is currently selected. That gateway is marked as non memory mapped when generating for Xilinx JTAG hardware co-simulation.

#### Example 2:

```
xlSetNonMemMap(gcbh, 'Nallatech', 'xdspkit');
```

The first parameter in the example returns the handle of the block that is currently selected. That gateway is marked as non memory mapped when generating for Nallatech's xTreme DSP kit.

### See Also

[Using Hardware Co-Simulation](#), [Supporting New Platforms](#)

## xlSetUseHDL

This function sets the 'Use behavioral HDL' option of blocks in a model or subsystem.

### Syntax

```
xlSetUseHDL(system, mode)
```

### Description

The model or system specified in the parameter system is set to either use cores or behavioral HDL, depending on the mode. Mode is a number, where 0 refers to using cores, and 1 refers to using behavioral HDL.

### Examples

Example 1:

```
xlSetUseHDL(gcs, 0)
```

This call sets the currently selected system to use cores.

### See Also

[xlSetNonMemMap](#), [xlSBDBuilder](#)



## xlSwitchLibrary

Replaces the HDL library references in the target directory with the specified library name.

### Syntax

```
xlSwitchLibrary(<target_directory>, <from_library_name>,  
<to_library_name>)
```

### Description

Replaces all HDL library references to <from\_library\_name>, with <to\_library\_name> in a System Generator design located in directory <target\_directory>.

### Examples

Example 1:

The following command runs `xlSwitchLibrary` on a target directory created by System Generator named `.\netlist` and switches the default library from `'work'` to `'design1'`:

```
>> xlSwitchLibrary('.\netlist_w_dcm', 'work', 'design1')  
INFO: Switching HDL library references in design 'basicmult_dcm_mcw'  
...  
INFO: A backup of the original files can be found at  
'D:\Matlab\work\Basic\netlist_w_dcm\switch_lib_backup.TlOy'.  
INFO: Processing file 'basicmult.vhd' ...  
INFO: Processing file 'basicmult_mcw.vhd' ...  
INFO: Processing file 'basicmult_dcm_mcw.vhd' ...  
INFO: Processing file 'xst_basicmult.prj' ...  
INFO: Processing file 'vcom.do' ...  
INFO: Processing file 'vsim.do' ...  
INFO: Processing file 'pn_behavioral.do' ...  
INFO: Processing file 'pn_posttranslate.do' ...  
INFO: Processing file 'pn_postmap.do' ...  
INFO: Processing file 'pn_postpar.do' ...  
INFO: Processing file 'basicmult_dcm_mcw.ise' ...
```

## xlTBUtils

The xlTBUtils command provides access to several features of the Xilinx block. This includes access to the layout, rerouting functions and to functions that return selected blocks and lines.

### Syntax

```
xlTBUtils(function, args)
e.g.
xlTBUtils('ToolBar')
xlTBUtils('Layout',struct('verbose',1,'autoroute',0))
xlTBUtils('Layout',optionStruct)
xlTBUtils('Redrawlines',struct('autoroute',0))
xlTBUtils('RedrawLines',optionStruct)
[lines,blks]=xlTBUtils('GetSelected','All')
```

### Description

#### xlTBUtils(function [,args])

xlTBUtils is a collection of functions that are used by the Xilinx Toolbar block. The function argument specifies the name of the function to execute. Further arguments (if required) can be tagged on as supplementary arguments to the function call. Note that the function argument string is not case sensitive. Possible values are enumerated below and explained further in the relevant subtopics.

Function	Description
'ToolBar'	Launches the Xilinx Toolbar GUI. If the GUI is already open, it is brought to the front.
'Layout'	Runs the layout algorithm on a model to place and reroute lines on the model. Layout can be customized using the option structure that is detailed below.
'RedrawLines'	Runs the routing algorithm on a model to reroute lines on the model. RedrawLines can be customized using the option structure detailed below.
'GetSelected'	Returns MATLAB Simulink handles to blocks and lines that are selected on the system in focus

#### 'xlTBUtils('Layout',optionStruct)

Automatically places and routes a Simulink model. optionStruct is a MATLAB struct data-type, that contains the parameters for Layout. The optionStruct argument is optional.

Layout expects circuits to be placed left to right. After placement, Layout uses Simulink to autoroute the wire connections. Simulink will route avoiding anything visible on screen, including block labels. Setting "ignore\_labels" will 'allow' Simulink to route over labels – after which it is possible to manually move the labels to a more reasonable location. Note that field names are case sensitive.

Field Names	Description [Default values]
x_pitch, y_pitch	The gaps (pitch) between block (pixels). x_pitch specifies the amount of spacing to leave between blocks horizontally, and y_pitch specifies vertical spacing. [30].
x_start, y_start	Left (x_start) and top(y_start) margin spacing (pixels). The amount of spacing to leave on the left and top of a model. [10].

Field Names	Description [Default values]
autoroute	Turns on Simulink auto-routing of lines. (1   0) [1]
ignore_labels	When auto-routing lines, Simulink will attempt to auto-route around text labels. Setting ignore_labels to 1 will minimize text label size during the routing process.
sys	Name of the system to layout. [gcs]
verbose	When set to 1, a wait bar is shown during the layout process.

### xITBUtils('RedrawLines',optionStruct)

The RedrawLines command will redraw all lines in a Simulink model. If there are lines selected, only selected lines are redrawn otherwise all lines are redrawn. If a branch is selected, the entire line is redrawn; main trunk and all other sub-branches.

Field Names	Description [Default values]
autoroute	Turns on Simulink auto-routing of lines. (1   0) [1]
sys	Name of the system to layout. [gcs]

### [lines,blks]=xITBUtils('GetSelected',arg)

The GetSelected command returns handles to selected blocks and lines of the system in focus. The argument arg is optional. It should be a one of the string values described in the table below.

Field Names	Description [Default values]
'all'	Gets both selected lines and blocks (default).
'lines'	Gets only selected lines.
'blocks'	Gets only selected blocks.

The GetSelected command will return an array with two items, an array of a structure containing line information (lines) and an array of block handles (blks). If the 'lines' argument is used, blks is an empty array; similarly when the 'blocks' argument is used, lines is an empty array.

## Examples

### Example 1a: Performing Layouts

```
a.verbose = 1;
a.autoroute= 0;
xlTBUtills('Layout',a);
```

This will invoke the layout tool with verbose on and autoroute off.

### Example 1b: Performing Layouts

```
xlTBUtills('Layout',struct('verbose',1,'autoroute',0));
```

This will also invoke the layout tool with verbose on and autoroute off.

### Example 2: Redrawing lines

```
xlTBUtills('Redrawlines',struct('autoroute',0));
```

This will redraw the lines of the current system, with auto-routing off.

### Example 3: Getting selected lines and blocks

```
[lines,blks]=xlTBUtills('GetSelected')
lines =
```

1x3 struct array with fields:

```
Handle
Name
Parent
SrcBlock
SrcPort
DstBlock
DstPort
Points
Branch
```

```
blks =
```

```
1.0e+003 *
```

```
3.0320
```

```
3.0480
```

This will return all selected lines and blocks in the current system. In this case, 3 lines and 2 blocks were selected. The first line handle can be accessed using the command

```
lines(1).Handle
```

```
ans =
```

```
3.0740e+003
```

The handle to the first block can be accessed using the command

```
blks(1)
```

```
ans =
```

```
3.0320e+003
```

## Remarks

The actions performed by Layout and RedrawLines will not be in the undo stack. Save a copy of the model before performing the actions, in order to revert to the original model.

This product contains certain software code or other information ("AT&T Software") proprietary to AT&T Corp. ("AT&T"). The AT&T Software is provided to you "AS IS". YOU ASSUME TOTAL RESPONSIBILITY AND RISK FOR USE OF THE AT&T SOFTWARE. AT&T DOES NOT MAKE, AND EXPRESSLY DISCLAIMS, ANY EXPRESS OR IMPLIED WARRANTIES OF ANY KIND WHATSOEVER, INCLUDING, WITHOUT LIMITATION, THE IMPLIED WARRANTIES OF MERCHANTABILITY OR FITNESS FOR A PARTICULAR PURPOSE, WARRANTIES OF TITLE OR NON-INFRINGEMENT OF ANY INTELLECTUAL PROPERTY RIGHTS, ANY WARRANTIES ARISING BY USAGE OF TRADE, COURSE OF DEALING OR COURSE OF PERFORMANCE, OR ANY WARRANTY THAT THE AT&T SOFTWARE IS "ERROR FREE" OR WILL MEET YOUR REQUIREMENTS.

Unless you accept a license to use the AT&T Software, you shall not reverse compile, disassemble or otherwise reverse engineer this product to ascertain the source code for any AT&T Software.

© AT&T Corp. All rights reserved. AT&T is a registered trademark of AT&T Corp.

## See Also

[Toolbar](#), [xlAddTerms](#)

## xlTimingAnalysis

The System Generator timing analyzer GUI is typically launched by using the Timing and Power Analysis compilation target from the System Generator GUI in MATLAB. The xlTimingAnalysis MATLAB command is another way of launching the timing analyzer GUI. The Timing and Power Analysis compilation target causes the tool to compile the design, run place and route, and perform other operations prior to displaying the timing analyzer GUI. By using the xlTimingAnalysis command, it is possible to launch the GUI on previously generated timing data without performing the additional operations of the compilation target.

### Syntax

```
xlTimingAnalysis(target_directory);
```

### Description

Calling xlTimingAnalysis with the name of a directory that contains timing data will launch the System Generate Timing Analyzer GUI.

The timing analyzer GUI will display the data that is contained in the timing.twx and name\_translations data files in the specified target directory.

The target directory name can be either a relative or an absolute path name.

### Example

```
>> xlTimingAnalysis('timing')
```

Where 'timing' is the name of the target directory in which a prior timing analysis was carried out.

## xlUpdateModel

If you have a model that was created in System Generator v7.1 or earlier, you must update the model to be compatible with v9.1.01 and beyond. To update a model, you run the MATLAB command `xlUpdateModel` that invokes a conversion script.

*Please be advised that the conversion script does not automatically save an old version of your model as it updates the design nor save a new version of your model after conversion. You can either make a back up copy of your model before running the conversion script, or you can save the updated model with a new name.*

Some models can require some manual modification after running `xlUpdateModel`. The function will point out any necessary changes that must be made manually.

### Syntax

```
xlUpdateModel('my_model_name');  
xlUpdateModel('my_model_name', 'lib');  
xlUpdateModel('my_model_name', 'assert');
```

### Description

#### Updating v2.x and Prior Models

If you are upgrading from versions of System Generator earlier than **v3.1**, you must obtain System Generator v7.x and update your models to v7.x before you can update them to v9.1.01.

#### Updating v3.x, v6.x and v7.x Models

This section describes the process of upgrading a Xilinx System Generator v3.x, v6.x or v7.x model to work with v9.1.01.

**Note:** Any reference to v3.x or v6.x in this section can be used interchangeably with v7.x.

The basic steps for upgrading a v7.x model to v9.1.01 is as follows: 1) Save a backup copy of your v7.1 model and user-defined libraries that your model uses 2) Run `xlUpdateModel` on any libraries first and then on your model 3) Read the report produced by `xlUpdateModel` and follow the instructions 4) Check that your model runs under v9.1.01.

These steps are described in greater detail below.

1. Save a backup copy of your v7.1 model and user-defined libraries that your model uses.
2. Run the `xlUpdateModel` Function

From the MATLAB console, `cd` into the directory containing your model. If the name of your model is `designName.mdl`, type `xlUpdateModel('designName')`.

The `xlUpdateModel` function performs the following tasks:

- ◆ Updates each block in your v7.x design to a corresponding v9.1.01 block with equivalent settings.
- ◆ Writes a report explaining all of the changes that were made. This report enumerates changes you might need to make by hand to complete the update.

In most cases, `xlUpdateModel` produces an equivalent v9.1.01 model. However, there are a few constructs that might require you to edit your model. It is important that you read the report and follow the remaining steps in this section.

3. Read the `xlUpdateModel` report and Follow the Instructions

If the report contains the issues listed below, manual intervention is required to complete the conversion.

- a. Xilinx System Generator v7.x models containing removed blocks  
The following blocks have been removed from System Generator: CIC, Clear Quantization Error, Digital Up Converter, J.83 Modulator, Quantization Error, Sync.
- b. Xilinx System Generator v7.x Models that Contain Deprecated Blocks  
The DDSv4.0 block still exist in System Generator, but has been deprecated:
- c. Xilinx System Generator v7.x Models Utilizing Explicit Sample Periods  
The explicit sample period fields have been removed from most non-source blocks in System Generator v9.1.01. Source blocks (e.g., Counter block) continue to allow the specification of explicit sample periods. When upgrading models containing feedback loops, Assert blocks must typically be added by hand after xlUpdateModel has been run. This is necessary in order to help System Generator determine appropriate rates and types for the path. The following error message is an indication that an Assert block is required:

**“The data rates could not be established for the feedback paths through this block. You might need to add Assert blocks to instruct the system”**

In such a case, you should augment each feedback loop with an Assert block, and specify rates and types explicitly on this block.

The update script will annotate the converted model wherever the v7.1 model asserted an explicit period. In the converted model, you will most often not need to insert Assert blocks. To find out where you need them, try to update the diagram (the Update Diagram control is under the Edit menu). If rates do not resolve, you will need to insert one or more Assert blocks.

The update script can be configured to automatically insert Assert blocks immediately following blocks configured with an explicit sample period setting. To use this option, run the following command:

```
xlUpdateModel (designName, 'assert')
```

4. Save and Close the updated model.  
If you did not previously make a backup copy of the old model, you can save the updated model under a new name to preserve the old model.
5. Verify that Your model Runs Under System Generator v9.1.01.  
If you have followed the instructions in the previous steps, your model should run with System Generator v9.1.01. Open the model with System Generator v9.1.01 and run it.



## Examples

**Example 1:**

```
>> xlUpdateModel('my_model_name');
```

Update the file `my_model_name.mdl` that is located in the current working directory.

**Example 2:**

```
>> xlUpdateModel('my_model_name', 'lib');
```

Update the file `my_model_name.mdl` that is located in the current working directory, along with the libraries that are associated with the model.

**Example 3:**

```
>> xlUpdateModel('my_model_name', 'assert');
```

Update the file `my_model_name.mdl` that is located in the current working directory. Add **Assert** blocks where necessary.

## xlVDMACreateProject

The xlVDMACreateProject utility takes a System Generator design with a VDMA Interface block, and creates an ISE project with a top-level module that stitches the System Generator design with an XPS sub-module that instantiates the actual VDMA, AXI interconnect, and MIG IP.

### VDMA

The created ISE and XPS projects are initially set up for one of the following boards, based on the FPGA device chosen for the System Generator design:

- Xilinx ML605 for all Virtex-6 devices
- Xilinx SP601 for all Spartan-6 LX devices
- Xilinx SP605 for all Spartan-6 LXT devices

Other device families are currently not supported.

To customize the ISE and XPS projects for a different board, do the following:

1. Open the generated ISE project in Project Navigator.
2. Double click the XPS sub-module to open the XPS GUI.
3. From the XPS GUI, customize the MIG and clock generator based on the DDR settings for the target board.
4. Close the XPS GUI and go back to Project Navigator.
5. Edit the generated top-level HDL if the DCM/MMCM settings do not match the target board.
6. Edit the generated top-level UCF if the constraints for the system clock do not match the target board.

### Usage:

```
xlVDMACreateProject (NetlistDirectory, TopLevelName, Options)
```

You should create the ISE and XPS projects for the System Generator design in the `NetlistDirectory` directory. If a `TopLevelName` is specified, the top-level module uses the given `TopLevelName` as entity name. Otherwise, the default entity name 'vdma\_top' is used.

Optional options can be specified through the `OPTIONS` argument, which is a MATLAB struct. The following options are supported:

**Debug:** If this value is true, ChipScope AXI monitors are inserted to various AXI interfaces in the design: `M_AXI_MM2S` and `M_AXI_S2MM` interfaces between the VDMA and AXI interconnect IP, and the `S_AXI` interface between the AXI interconnect and MIG IP.

## xlVersion

It is possible to have multiple versions of System Generator installed. The MATLAB command `xlVersion` displays which versions are installed, and makes it possible to switch from one to another. Occasionally, it is necessary to restart MATLAB to make it possible to switch versions; the `xlVersion` command will instruct you to do so in these cases.

If you install System Generator 8.1 after you install 8.2, you need to install 8.2 again in order to make `xlVersion` work.

### Syntax

```
xlVersion;  
xlVersion ver;  
xlVersion -add directory;
```

### Description

A call to `xlVersion` with no parameters will display the current version of System Generator installed, and also all available versions.

The `ver` option specifies the version of System Generator to switch to.

The `-add` option allows a directory to be specified. The directory is expected to hold a System Generator installation. The specified instance of System Generator is loaded as the current working System Generator installation.

### See Also

[Real-Time Signal Processing using Hardware Co-Simulation](#)



# *System Generator GUI Utilities*

---

Xilinx BlockAdd	Facilitates the rapid addition of Xilinx blocks (and a limited set of Simulink blocks) to a Simulink model.
Xilinx Tools > Save as blockAdd default	Facilitates the rapid addition of pre-configured Xilinx blocks to a Simulink model. This feature allows you to pre-configure a block, then add multiple copies of the pre-configured block using the BlockAdd feature.
Xilinx BlockConnect	Facilitates the rapid connection of blocks in a Simulink model.
Xilinx Tools > Terminate	Facilitates the rapid addition of Simulink terminator blocks on open output ports and/or Xilinx Constant Blocks on open input ports.

## Xilinx BlockAdd

Facilitates the rapid addition of Xilinx blocks (and a limited set of Simulink blocks) to a Simulink model.

### How to Invoke

#### Method 1

Right-click on the Simulink canvas and select **Xilinx BlockAdd**.

#### Method 2

Execute the short cut **Ctrl 1 (one)**.

#### Method 3

From the Simulink model pull down menu, select the following item:

**Tools > Xilinx > BlockAdd Ctrl 1**

### How to Use

Right-click on the Simulink canvas and select **Xilinx BlockAdd**.

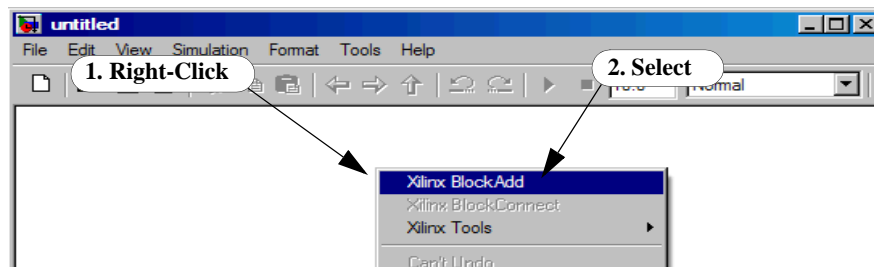

Right-click on the Simulink canvas and select **Xilinx BlockAdd**.

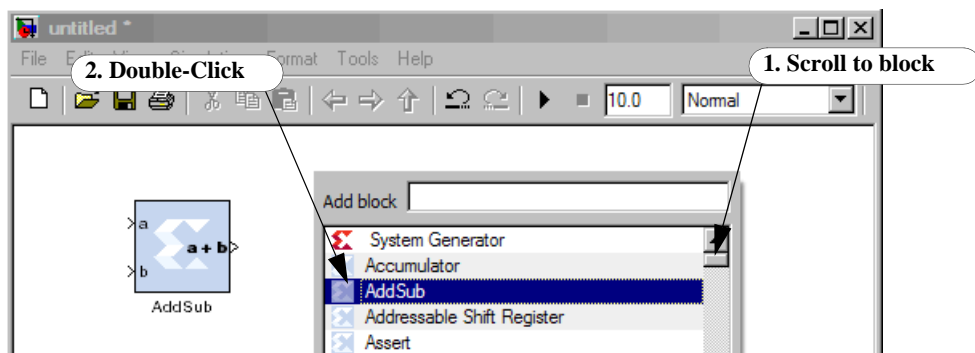

As shown below, to rapidly scroll to a block, enter the first few letters of the block name in the top entry box. To add multiple blocks, select each block using **Shift-Click**, then press **Enter**.

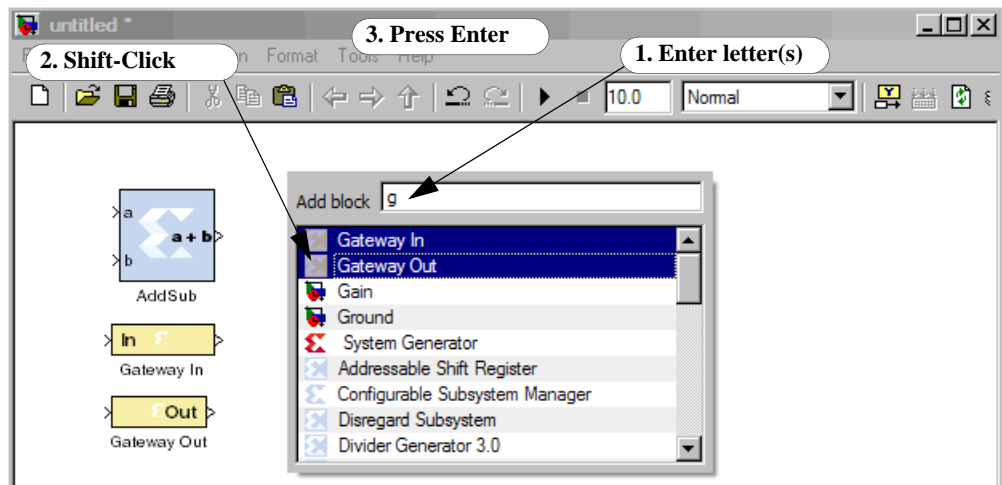

To add multiple copies of the same block, add a block, select the block, press **Ctrl-C**, then **Ctrl-V**, **Ctrl-V**, etc.

To dismiss the Add block window, press **Esc**.

## Xilinx Tools > Save as blockAdd default

Facilitates the rapid addition of pre-configured Xilinx blocks to a Simulink model. This feature allows you to pre-configure a block, then add multiple copies of the pre-configured block using the BlockAdd feature.

### How to Use

Assume you need to add multiple Gateway In blocks of type **Boolean** to a model.

1. Add one Gateway In block to the model.
2. Double click on the Gateway In block, change the Output type to **Boolean** and click OK.
3. Select the modified Gateway In block, right-click and select **Xilinx Tools > Save as blockAdd default**.
4. Now, every time you add addition Gateway In blocks to the model using the BlockAdd feature, the block is of Output type Boolean.

### How to Restore the Block Default

1. Select a block with pre-configured (changed) defaults.
2. Right-click and select **Xilinx Tools > Clear blockAdd defaults**.



# Xilinx BlockConnect

Facilitates the rapid connection of blocks in a Simulink model.

## Simple Connections

- As shown below, select an open port of a block, right click, and select **Xilinx BlockConnect**.

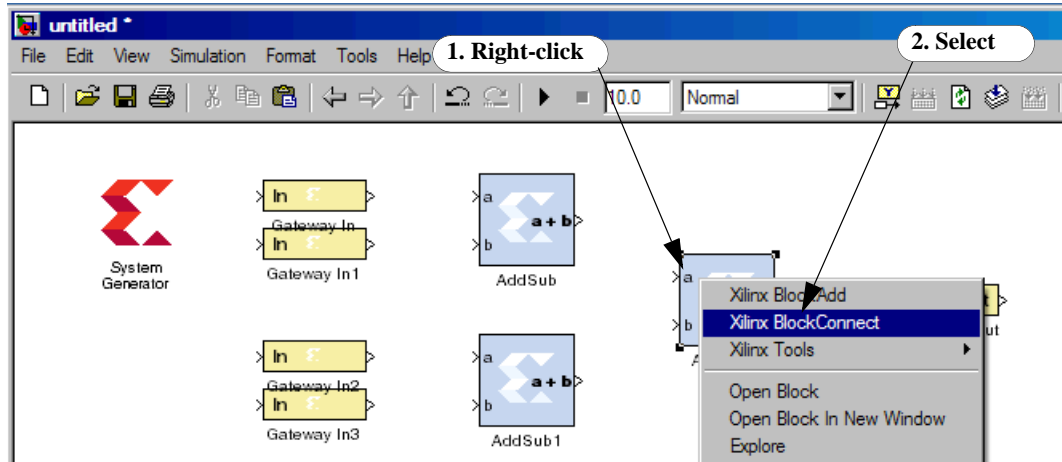

- BlockConnect proposes the nearest connection with a green line. To confirm, you can double click the selected connection in the table. The connection then turns black. Otherwise, select another connection in the table to see if the new green line connection is correct.

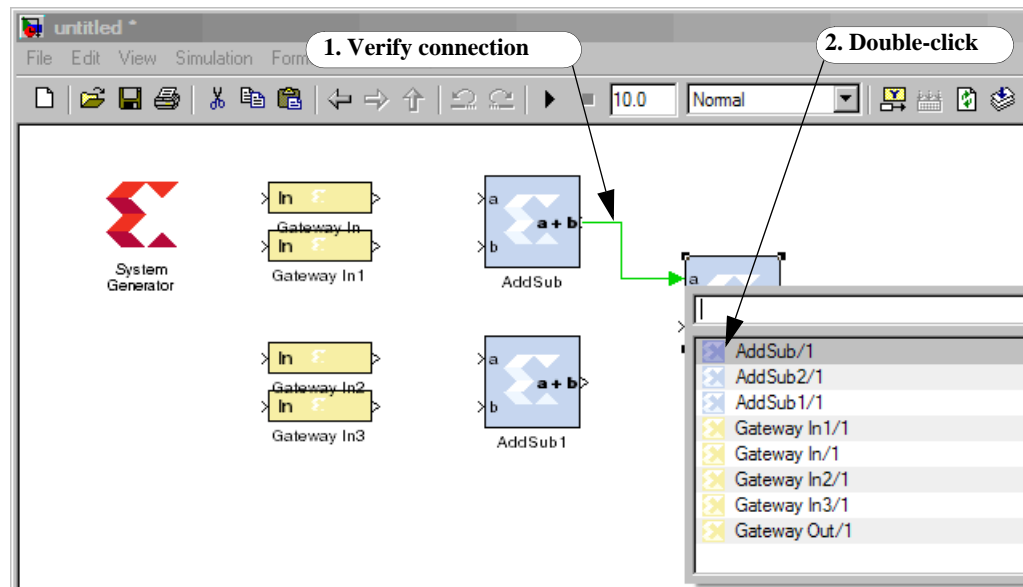

## Smart Connections

As shown below, a “lightning bolt” icon indicates a “smart” connection. Smart connections have intelligence built in to help you manage the connection. For example, right-clicking on a block with an AXI interface allows you to (1) group/separate the AXI signals to/from a bus. Or (2) connect to other ports with the same number of AXI connections.

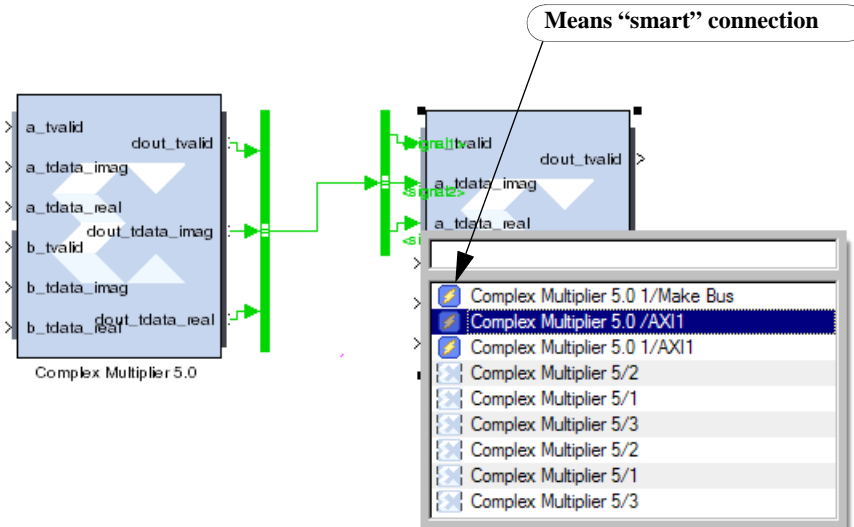

No port data type checking is performed and any AXI ports with the same number of ports are allowed to connect.

In another smart connection example below, right clicking on the **Accumulator** block output, selecting **BlockConnect**, and double clicking on **Scope** creates a smart connection to the Scope block. The Gateway Out block is added automatically. .

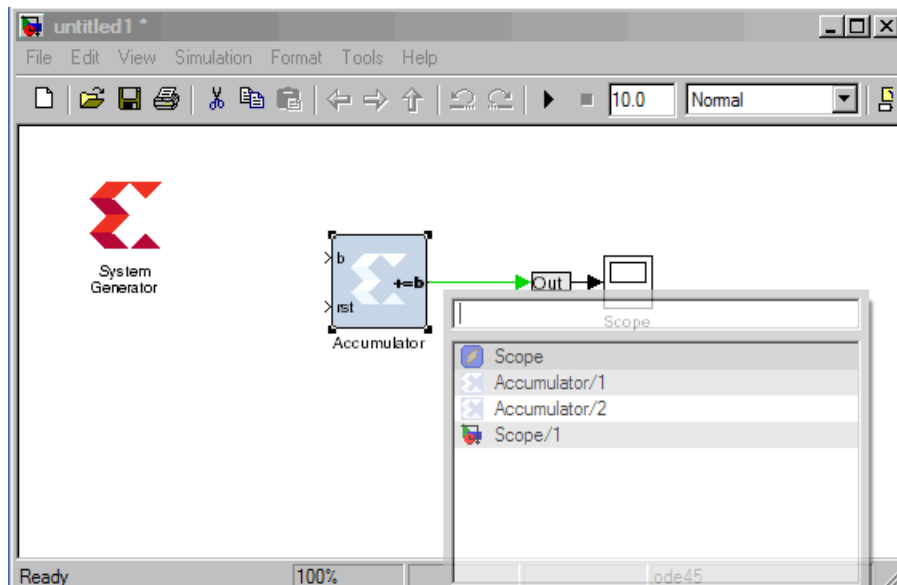

If a second connection is made to this Scope block, a second port is automatically added to the Scope. The driving signal name is also used to name the signal driving the scope.

# Xilinx Tools > Terminate

Facilitates the rapid addition of Simulink terminator blocks on open output ports and/or Xilinx Constant Blocks on open input ports.

## How to Use

### Terminating Open Outputs

Consider the following model with open input and output ports:

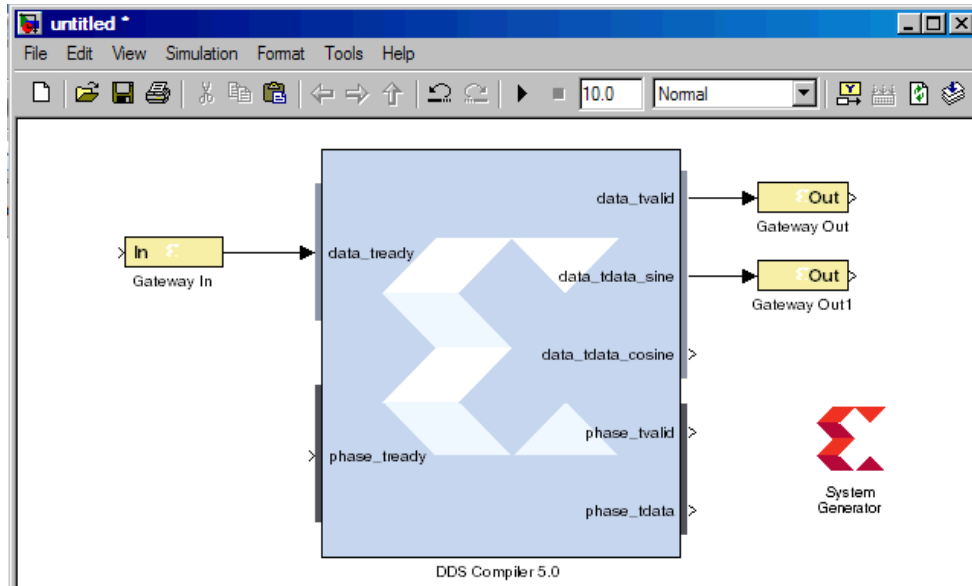

Right-click on the DDS Compiler 5.0 block in this case and select:

**Xilinx Tools > Terminate > Outputs**

The following graphic illustrates the resulting terminated outputs.

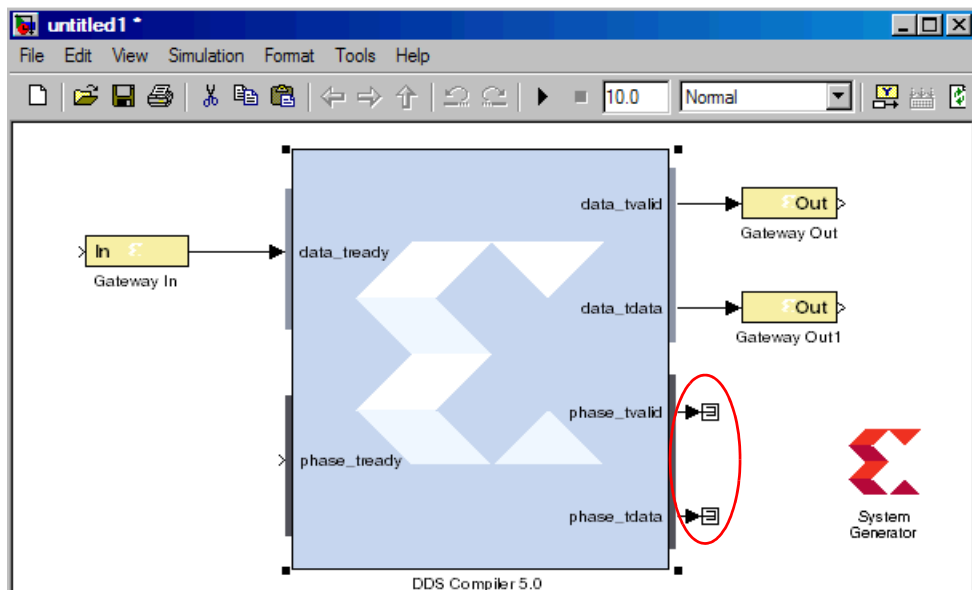

## Terminating Open Inputs

Consider the following model with an open input port:

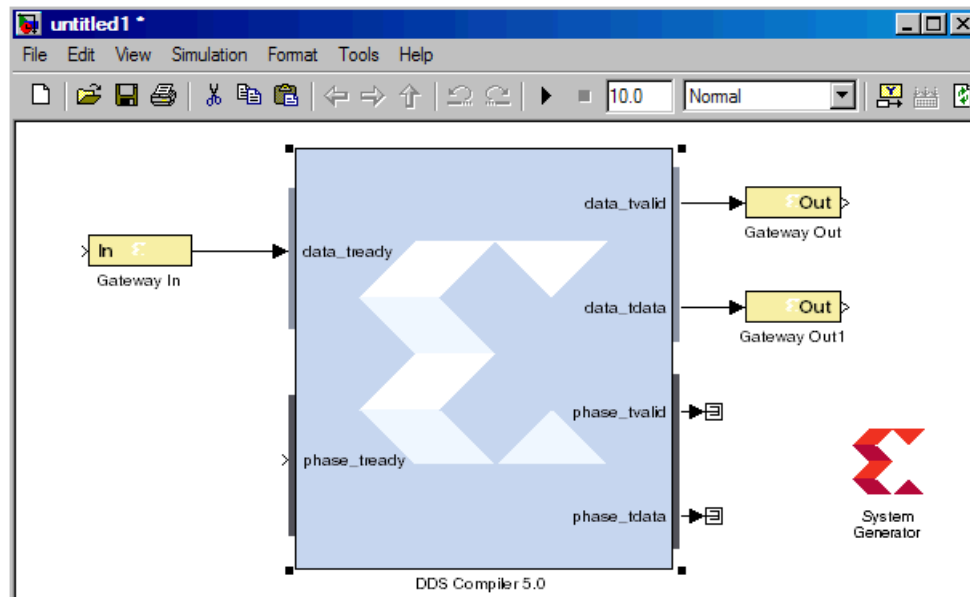

Right-click on the DDS Compiler 5.0 block and select:

**Xilinx Tools > Terminate > Inputs**

The following graphic illustrates the resulting terminated input.

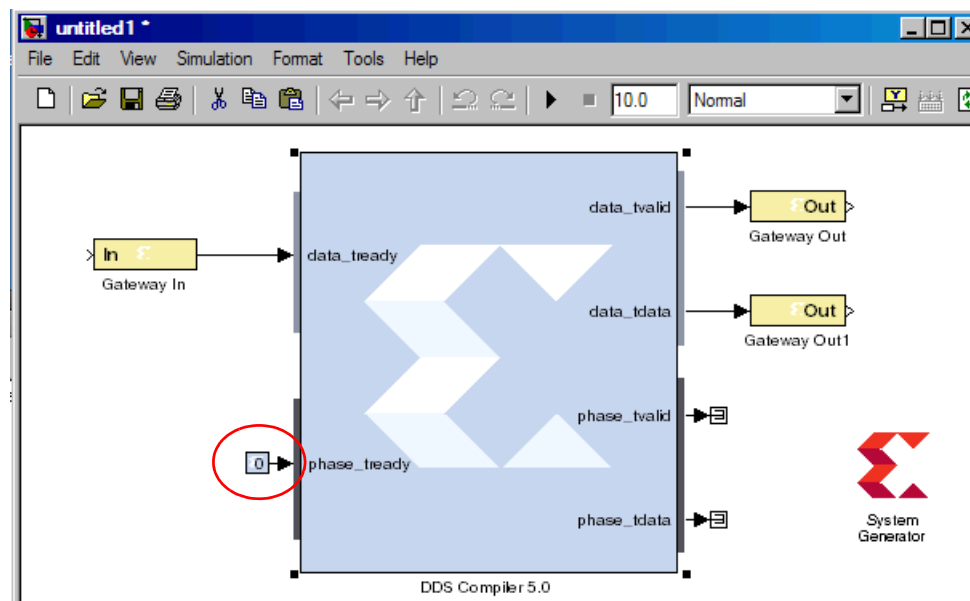

### Verifying Input Port Data Type Requirements

System Generator connects each open input port to a Xilinx Constant Block. The new Constant blocks are set to the following default values:

**Type:** Signed (2's comp)

**Constant value:** 0

**Number of bits:** 16

**Binary point:** 14

This terminate tool does not do data type checking on the input ports. If an open port requires a different data type, for example a Boolean data type, you'll need to double-click on the Constant block and change the Output Type to **Boolean**.

To check for data type mismatches, click on the Simulink model canvas and enter **Ctrl-D**. System Generator will report on all the data type mismatches, if there are any.



# Programmatic Access

---

## System Generator API for Programmatic Generation

### Introduction

A script of System Generator for programmatic generation (PG API script) is a MATLAB M-function file that builds a System Generator subsystem by instantiating and interconnecting **xBlock**, **xSignal**, **xInport**, and **xOutport** objects. It is a programmatic way of constructing System Generator diagrams (for example, subsystems). As is demonstrated below with examples, the top-level function of a System Generator programmatic script is its entry point and must be invoked through an **xBlock** constructor. Upon constructor exit, MATLAB adds the corresponding System Generator subsystem to the corresponding model. If no model is opened, a new “untitled” model is created and the System Generator subsystem is inserted into it.

The **xBlock** constructor creates an **xBlock** object. The object can be created from a library block or it can be a subsystem. An **xSignal** object corresponds to a wire that connects a source block to a target. An **xInport** object instantiates a Simulink Inport and an **xOutport** object instantiates a Simulink Outport

The API also has one helper function, **xsub2script** which converts a Simulink diagram to a programmatic generation script.

The API works in three modes: *learning mode*, *production mode*, and *debugging mode*. The learning mode allows you to type in the commands without having a physical script file. It is very useful when you learn the API. In this mode, all blocks, ports and subsystems are added into a Simulink model named “untitled”. Please remember to run **xBlock** without any argument or to close the untitled model before starting a new learning session. The production mode has an M-function file and is invoked through the **xBlock** constructor. You will have a subsystem generated. The subsystem can be either in the existing model or can be inserted in a new model. The debugging mode works the same as the production mode except that every time a new object is created or a new connection is established, the Simulink diagram is rerouted. It is very useful when you debug the script that you set some break points in the script or single step the script.

## xBlock

The `xBlock` constructor creates an `xBlock` object. The object can be created from a library block or it can be a subsystem. The `xBlock` constructor can be used in three ways:

- to add a leaf block to the current subsystem,
- to add a subsystem to the current subsystem,
- to attach a top-level subsystem to a model.

The `xBlock` takes four arguments and is invoked as follows.

```
block = xBlock(source, params, inports, outports);
```

If the source argument is a string, it is expected to be a library block name. If the source block is in the `xbsIndex_r4` library or in the Simulink built-in library, you can use the block name without the library name. For example, calling `xBlock('AddSub', ...)` is equivalent to `xBlock('xbsIndex_r4/AddSub', ...)`. For a source block that is not in the `xbsIndex_r4` library or built-in library, you need to use the full path, for example, `xBlock('xbsTest_r4/Assert Relation', ...)`. If the source argument is a function handle, it is interpreted as a PG API function. If it is a MATLAB struct, it is treated as a configuration struct to specify how to attach the top-level to a model.

The `params` argument sets up the parameters. It can be a cell array for position-based binding or a MATLAB struct for name-based binding. If the source parameter is a block in a library, this argument must be a cell array. If the source parameter is a function pointer, this argument must be a cell array.

The `inports` and `outports` arguments specify how subsystem input and output ports are bound. The binding can be a cell array for position-based binding or a MATLAB struct for name-based binding. When specifying an inport/outport binding, an element of a cell array can be an `xSignal`, an `xInport`, or an `xOutport` object. If the port binding argument is a MATLAB struct, a field of the struct is a port name of the block, a value of the struct is the object that the port is bound to.

The two port binding arguments are optional. If the arguments are missing when constructing the `xBlock` object, the port binding can be specified through the `bindParam` method of an `xBlock` object. The `bindParam` method is invoked as follows:

```
blockbindParam(inports, outports)
```

where `inports` and `outports` arguments specify the input and output port binding. In this case, the object `block` is create by `xBlock` with only two arguments, the source and the parameter binding.

Other `xBlock` methods include the following.

- `names = block.getOutletNames` returns a cell array of outlet names,
- `names = block.getInletNames` returns a cell array of inlet names,
- `nin = block.getNumInports` returns the number of inports,
- `nout = block.getNumoutports` returns the number of outports.
- `insigs = block.getInSignals` returns a cell array of in coming signals
- `outsigs = block.getOutSignals` returns a cell array of out going signals



## xInport

An xInport object represents a subsystem input port.

The constructor

```
port = xInport(port_name)
```

creates an xInport object with name port\_name,

```
[port1, port2, port3, ...] = xInport(name1, name2, name2, ...)
```

creates a list of input port with names, and

```
port = xInport
```

creates an input port with an automatically generated name.

An xInport object can be passed for port binding.

### METHODS

```
outsigs = port.getOutSignals
```

returns a cell array of out going signals.

## xOutput

An xOutput object represents a subsystem output port.

The constructor

```
port = xOutput(port_name)
```

creates an xOutput object with name port\_name,

```
[port1, port2, port3, ...] = xOutput(name1, name2, name2, ...)
```

creates a list of output port with names, and

```
port = xOutput
```

creates an output port with an automatically generated name.

An xOutput object can be passed for port binding.

### METHODS

```
port.bind(obj)
```

connects the object to port, where port is an xOutput object and obj is an xSignal or xInport object.

```
insigs = port.getInSignals
```

returns a cell array of incoming signals.

## xSignal

An `xSignal` represents a signal object that connects a source to targets.

The constructor

```
sig = xSignal(sig_name)
```

creates an `xSignal` object with name `sig_name`,

```
[sig1, sig2, sig3, ...] = xSignal(name1, name2, name2, ...)
```

creates a list of signals with names, and

```
sig = xSignal
```

creates an `xSignal` for which a name is automatically generated.

An `xSignal` object can be passed for port binding.

### METHODS

```
sig.bind(obj)
```

connects the `obj` to `sig`, where `sig` is an `xSignal` object and `obj` is an `xSignal` or an `xInport` object.

```
src = sig.getSrc
```

returns a cell array of the source objects that are driving the `xSignal` object. The cell array can have at most one element. If the source is an input port, the source object is an `xInport` object. If the source is an output port of a block, the source object is a struct, having two fields `block` and `port`. The `block` field is an `xBlock` object and the `port` field is the port index.

```
dst = sig.getDst
```

returns a cell array of the destination objects that the `xSignal` object is driving. Each element can be either a struct or an `xOutport` object. It is defined same as the return value of the `getSrc` method.

## xsub2script

`xsub2script` is a helper function that converts a subsystem into the top level of a Sysgen script.

`xsub2script(subsystem)` converts the subsystem into the top-level script. The argument can also be a model.

By default, the generated M-function file is named after the name of the subsystem with white spaces replaced with underscores. Once the `xsub2script` finishes, a help message will guide you how to use the generated script. The main purpose of this `xsub2script` function is to make learning Sysgen Script easier. This is also a nice utility that allows you to construct a subsystem using graphic means and then convert the subsystem to a PG API M-function.

`xsub2script(block)`, where `block` is a leaf block, prints out the `xBlock` call that creates the block.

The following are the limitations of `xlsub2script`.

- If the subsystem has mask initialization code that contains function calls such as `gcb`, `set_param`, `get_param`, `add_block`, and so on, the function will error out and you must modify the mask initialization code to remove those Simulink calls.
- If there is an access to global variables inside the subsystem, you need add corresponding mask parameters to the top subsystem that you run the `xlsub2script`.
- If a block's link is broken, that block is skipped.

`xlsub2script` can also be invoked as the following:

```
xlsub2script(subsystem, options)
```

where `options` is a MATLAB struct. The `options` struct can have two fields: `forcewrite`, and `basevars`.

If `xlsub2script` is invoked for the same subsystem the second time, `xlsub2script` will try to overwrite the existing M-function file. By default, `xlsub2script` will pop up a question dialog asking whether to overwrite the file or not. If the `forcewrite` field of the `options` argument is set to be true or 1, `xlsub2script` will overwrite the M-function file without asking.

Sometimes a subsystem is depended on some variables in the MATLAB base workspace. In that case, when you run `xlsub2script`, you want `xlsub2script` to pick these base workspace variables and generate the proper code to handle base workspace variables. The `basevars` field of the `options` argument is for that purpose. If you want `xlsub2script` to pick up every variable in the base workspace, you need to set the `basevars` field to be `'all'`. If you want `xlsub2script` to selectively pick up some variables, you can set the `basevars` field to be a cell array of strings, where each string is a variable name.

The following are examples of calling `xlsub2script` with the `options` argument:

```
xlsub2script(subsystem, struct('forcewrite', true));
xlsub2script(subsystem, struct('forcewrite', true, 'basevars',
                               'all'));
options.basevars = {'var1', 'var2', 'var3'};
xlsub2script(subsystem, options);
xlsub2script(subsystem, struct('basevars', {'var1', 'var2',
                                           'var3'}));
```

**Note:** In MATLAB, if the field of a struct is a cell array, when you call the `struct()` function call, you need the extra `{}`.

## xBlockHelp

`xBlockHelp (<block_name>)` prints out the parameter names and the acceptable values for the corresponding parameters. When you execute `xBlockHelp` without a parameter, the available blocks in the `xbsIndex_r4` library are listed..

For example, when you execute the following in the MATLAB command line:

```
xBlockHelp('AddSub')
```

You'll get the following table in the transcript:

```
'xbsIndex_r4/AddSub' Parameter Table
```

Parameter	Acceptable value	Type
mode	'Addition' 'Subtraction' 'Addition or Subtraction'	String
use_carryin	'off' 'on'	String
use_carryout	'off' 'on'	String
en	'off' 'on'	String
latency	An Int value	Int
precision	'Full' 'User Defined'	String
arith_type	'Signed (2's comp)' 'Unsigned'	String
n_bits	An Int value	Int
bin_pt	An Int value	Int
quantization	'Truncate' 'Round (unbiased: +/- Inf)'	String
overflow	'Wrap' 'Saturate' 'Flag as error'	String
use_behavioral_HDL	'off' 'on'	String
pipelined	'off' 'on'	String
use_rpm	'off' 'on'	String

## PG API Examples

### Hello World

In this example, you will run the PG API in the *learning* mode where you can type the commands in the MATLAB command shell.

1. To start a new learning session, in MATLAB command console, run: `xBlock`.
2. Type the following three commands in MATLAB command console to create a new subsystem named 'Subsystem' inside a new model named 'untitled'.

```
[a, b] = xImport('a', 'b');  
s = xOutput('s');  
adder = xBlock('AddSub', struct('latency', 1), {a, b}, {s});
```

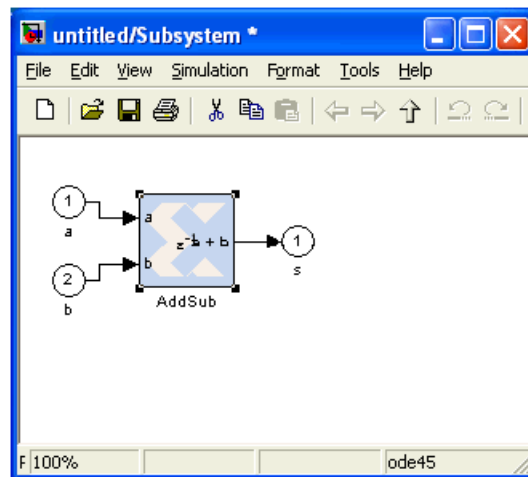

The above commands create the subsystem with two Simulink Inports `a` and `b`, an adder block having a latency of one, and a Simulink Output `s`. The two Inports source the adder which in turn sources the subsystem output. The `AddSub` parameter refers to the `AddSub` block inside the `xbsIndex_r4` library. By default, if the full block path is not specified, `xBlock` will search `xbsIndex_r4` and built-in libraries in turn. The library must be loaded before using `xBlock`. So please use `load_system` to load the library before invoking `xBlock`.

**Debugging tip:** If you type `adder` in the MATLAB console, System Generator will print a brief description of the adder block to the MATLAB console and the block is highlighted in the Simulink diagram. Similarly, you can type `a`, `b`, and `s` to highlight subsystem Inports and Outports.

## MACC

1. Run this example in the learning mode. To start a new learning session, run: `xBlock`.
2. Type the following commands in the MATLAB console window to create a multiply-accumulate function in a new subsystem.

```
[a, b] = xInport('a', 'b');
mac = xOutport('mac');
m = xSignal;
mult = xBlock('Mult', struct('latency', 0, 'use_behavioral_HDL', 'on'),
{a, b}, {m});
acc = xBlock('Accumulator', struct('rst', 'off', 'use_behavioral_HDL',
'on'), {m}, {mac});
```

By directing System Generator to generate behavioral HDL, the two blocks should be packed into a single DSP48 block. As of this writing, XST will do so only if you force the multiplier block to be combinational.

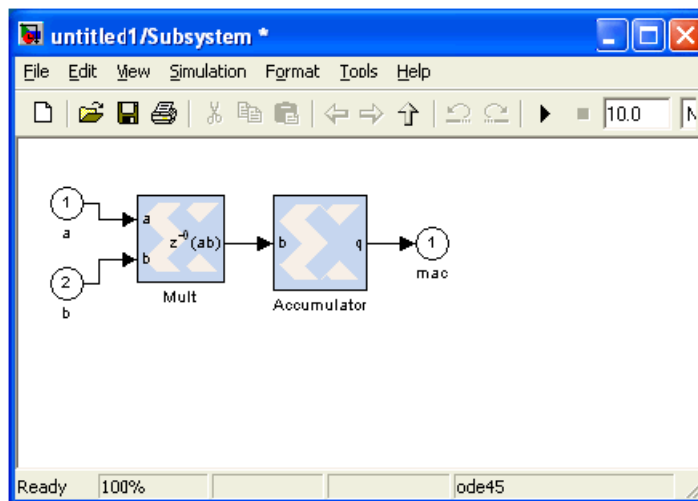

**Note:** If you don't close the model that is created in example 1, example 2 is created in a model named *untitled1*. Otherwise, a new model *untitled* is created for this example.

**Debugging tip:** The PG API provides functions to get information about blocks and signals in the generated subsystem. After each of the following commands, observe the output in the MATLAB console and the effect on the Simulink diagram.

```
mult_ins = mult.getInSignals
mult_ins{1}
mult_ins{2}
src_a = mult_ins{1}.getSrc
src_a{1}
m_dst = m.getDst
m_dst{1}
m_dst{1}.block
```

## MACC in a Masked Subsystem

If you want a particular subsystem to be generated by the PG API and pass parameters from the mask parameters of that subsystem to PG API, you need to run the PG API in *production* mode, where you need to have a physical M-function file and pass that function to the `xBlock` constructor.

1. First create the top-level PG API M-function file `MACC_sub.m` with the following lines.

```
function MACC_sub(latency, nbits)
[a, b] = xInport('a', 'b');
mac = xOutport('mac');
if latency <= 0
    error('latency must be positive');
elseif latency == 1
    a_in = a; b_in = b;
else
    [a_in, b_in] = xSignal;
    dblock1 = xBlock('Delay', struct('latency', latency - 1,
    'reg_retiming', 'on'), {a}, {a_in});
    block2 = xBlock('Delay', struct('latency', latency - 1,
    'reg_retiming', 'on'), {b}, {b_in});
end
m = xSignal;
mult = xBlock('Mult', struct('latency', 0, 'use_behavioral_HDL', 'on'),
{a_in, b_in}, {m});
acc = xBlock('Accumulator', struct('rst', 'off', 'n_bits', nbits,
'use_behavioral_HDL', 'on'), {m}, {mac});
```

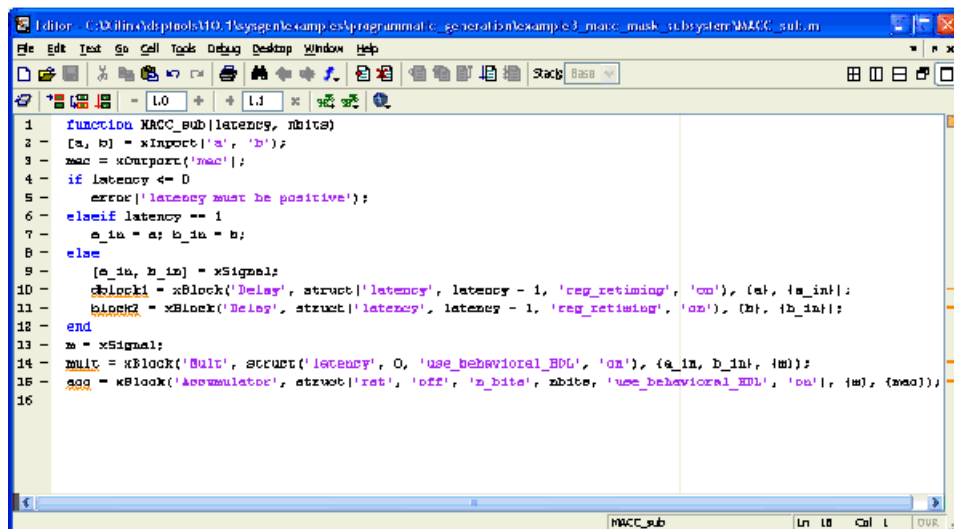

```
1 function MACC_sub(latency, nbits)
2 [a, b] = xInport('a', 'b');
3 mac = xOutport('mac');
4 if latency <= 0
5     error('latency must be positive');
6 elseif latency == 1
7     a_in = a; b_in = b;
8 else
9     [a_in, b_in] = xSignal;
10    dblock1 = xBlock('Delay', struct('latency', latency - 1, 'reg_retiming', 'on'), {a}, {a_in});
11    block2 = xBlock('Delay', struct('latency', latency - 1, 'reg_retiming', 'on'), {b}, {b_in});
12 end
13 m = xSignal;
14 mult = xBlock('Mult', struct('latency', 0, 'use_behavioral_HDL', 'on'), {a_in, b_in}, {m});
15 acc = xBlock('Accumulator', struct('rst', 'off', 'n_bits', nbits, 'use_behavioral_HDL', 'on'), {m}, {mac});
16
```

- To mask the subsystem defined by the script, add two mask parameters latency and nbits.

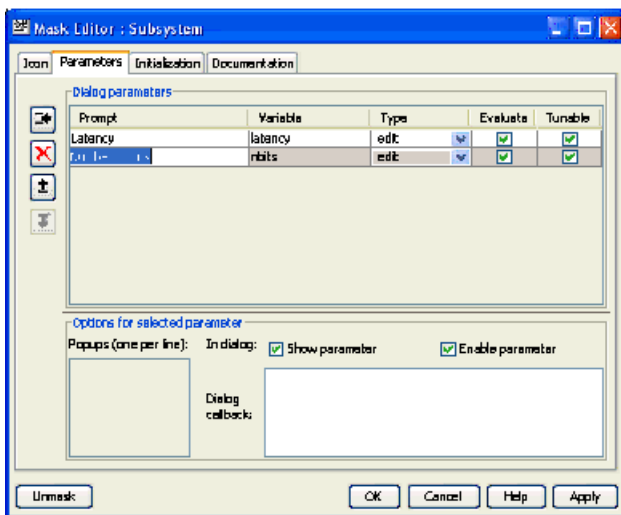

- Then put the following lines to the mask initialization of the subsystem.

```
config.source = str2func('MACC_sub');
config.toplevel = gcb;
xBlock(config, {latency, nbits});
```

In the *production* mode, the first argument of the `xBlock` constructor is a MATLAB struct for configuration, which must have a `source` field and a `toplevel` field. The `source` field is a function pointer points to the M-function and the `toplevel` is string specifying the Simulink subsystem. If the top-level field is 1, an untitled model is created and a subsystem inside that model is created.

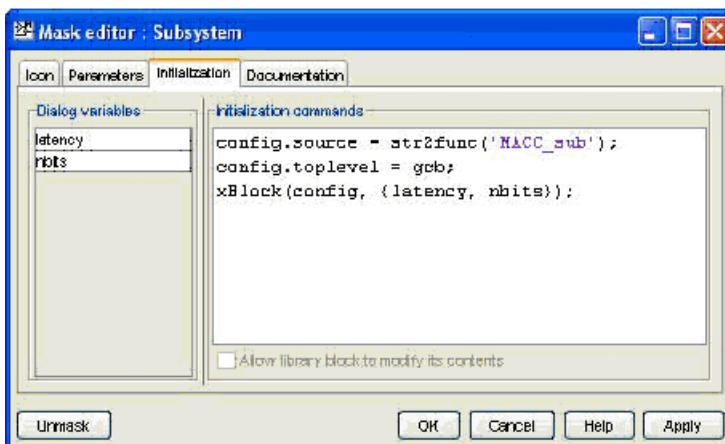

Alternatively you can use the MATLAB struct call to create the toplevel configuration:

```
xBlock(struct('source', str2func(MACC_sub), 'toplevel', gcb), {latency,
nbits});
```

Then click **OK**.



You'll get the following subsystem.

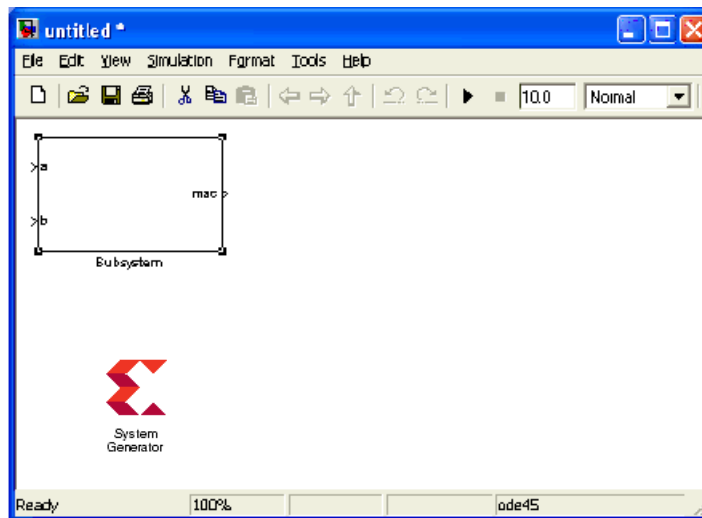

4. Set the mask parameters as shown in the following figure, then click **OK**:

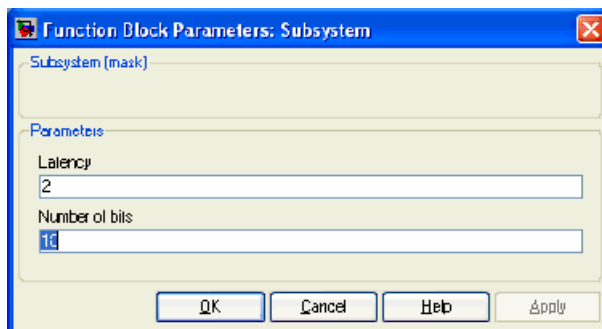

The following diagram is generated:

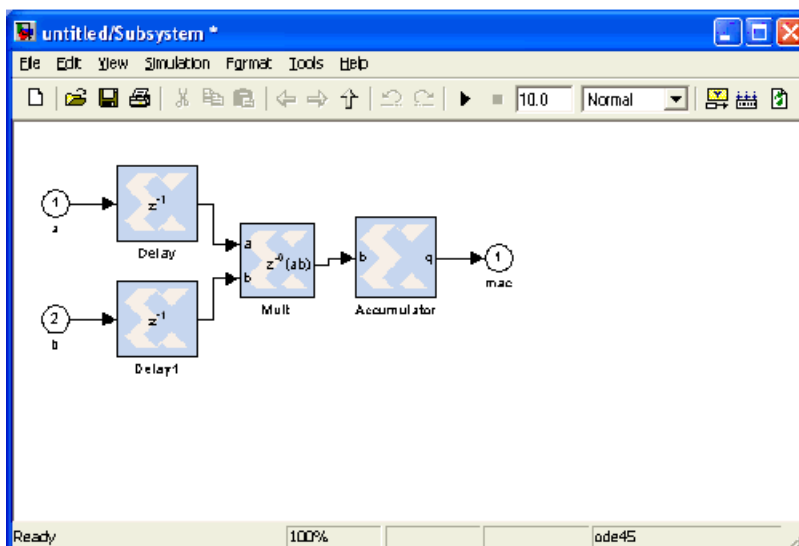

**Debugging Tip:** Open `MACC_sub.m` in the MATLAB editor to debug the function. By default the `xBlock` constructor will do an auto layout in the end. If you want to see the auto layout every time a block is added, invoke the toplevel `xBlock` as the following:

```
config.source = str2func('MACC_sub');  
config.toplevel = gcb;  
config.debug = 1;  
xBlock(config, {latency, nbits});
```

By setting the `debug` field of the configuration struct to be 1, you're running the PG API in debug mode where every action will trigger an auto layout.

**Caching Tip:** Most often you only want to re-generate the subsystem if needed. The `xBlock` constructor has a caching mechanism. You can specify the list of dependent files in a cell array, and set the `'depend'` field of the toplevel configuration with this list. If any file in the `'depend'` list is changed, or the argument list that passed to the toplevel function is changed, the subsystem is re-generated. If you want to have the caching capability for the `MACC_sub`, invoke the toplevel `xBlock` as the following:

```
config.source = str2func('MACC_sub');  
config.toplevel = gcb;  
config.depend = {'MACC_sub.m'};  
xBlock(config, {latency, nbits});
```

The `depend` field of the configuration struct is a cell array. Each element of the array is a file name. You can put a p-file name or an M-file name. You can also put a name without a suffix. The `xBlock` will use the first in the path.

## PG API Error/Warning Handling & Messages

### xBlock Error Messages

Condition	Error Message(s)
When calling <code>xBlock(NoSubSourceBlock, ...)</code> and the source block does not exist	Source block NoSubSourceBlock cannot be found.
When calling <code>xBlock(sourceblock, parameterBinding)</code> , and the parameters are illegal, <code>xBlock</code> will report the Illegal parameterization error. For example, <code>xBlock('AddSub', struct('latency', -1));</code>	Illegal parameterization: Latency Latency is set to a value of -1, but the value must be greater than or equal to 0
When the input port binding list contains objects other than <code>xSignal</code> or <code>xInport</code> :	Only objects of <code>xInport</code> or <code>xSignal</code> can appear in input binding list.
When the output port binding list contains objects other than <code>xSignal</code> or <code>xOutport</code> :	Only objects of <code>xOutport</code> or <code>xSignal</code> can appear in output binding list.
If the first argument of <code>xBlock</code> is a function pointer, the 2nd argument of <code>xBlock</code> is expected to be a cell array, otherwise, an error is thrown:	Cell array is expected for the second argument of the <code>xBlock</code> call
If the source configuration struct has <code>toplevel</code> defined, it must point to a Simulink subsystem and it must be a char array, otherwise, an error is thrown:	Top level must be a char array
If an object in the output binding list has already been driven by something, for example, if you try to have two driving sources, an error is thrown. (Note: the error message is not intuitive, we will fix it later.)	Source of <code>xSignal</code> object already exists

### xInport Error Messages

Condition	Error Message(s)
If you try to create an <code>xInport</code> object with the same name the second time, an error is thrown. For example, if you call <code>p = xInport('a', 'a')</code> .	A new block named 'untitled/Subsystem/a' cannot be added.

## xOutput Error Messages

Condition	Error Message(s)
If you try to create an xOutput object with the same name the second time, an error is thrown. For example, if you call <code>p = xOutput('a', 'a')</code> .	A new block named 'untitled/Subsystem/a' cannot be added.
If you try to bind an xOutput object twice, an error is thrown. For example, the following sequence of calls will cause an error: <code>[a, b] = xInport('a', 'b');</code> <code>c = xOutput('c');</code> <code>c.bind(a);</code> <code>c.bind(b);</code>	The destination port already has a line connection.

## xSignal Error Messages

Condition	Error Message(s)
If you try to bind an xSignal object with two sources, an error is thrown. For example, the following sequence of calls will cause an error: <code>[a, b] = xInport('a', 'b');</code> <code>sig = xSignal;</code> <code>sig.bind(a);</code> <code>sig.bind(b);</code>	Source of xSignal object already exists.

## xsub2script Error Messages

Condition	Error Message(s)
xsub2script is invoked without any argument.	An argument is expected for xsub2script
The first argument is not a subsystem or the model is not opened.	The first argument must be a model, subsystem, or a block. Please make sure the model is opened or the argument is a valid string for a model or a block.
A subsystem has simulink function calls in its mask initialization code.	Subsystem has Simulink function calls, such as <code>gcb</code> , <code>get_param</code> , <code>set_param</code> , <code>add_block</code> . Please remove these calls and run xsub2script again or you can pick a different subsystem to run xsub2script.
The subsystem has Goto blocks.	You have the following Goto blocks, please modify the model to remove them and run xsub2script again.

## M-Code Access to Hardware Co-Simulation

Hardware co-simulation in System Generator brings on-chip acceleration and verification capabilities into the Simulink simulation environment. In the typical System Generator flow, a System Generator model is first compiled for a hardware co-simulation platform, during which a

hardware implementation (bitstream) of the design is generated and associated to a hardware co-simulation block. The block is inserted into a Simulink model and its ports are connected with appropriate source and sink blocks. The whole model is simulated while the compiled System Generator design is executed on an FPGA device.

Alternatively, it is possible to programmatically control the hardware created through the System Generator hardware co-simulation flow using MATLAB M-code (M-Hwcosim). The M-Hwcosim interfaces allow for MATLAB objects that correspond to the hardware to be created in pure M-code, independent of the Simulink framework. These objects can then be used to read and write data into hardware.

This capability is useful for providing a scripting interface to hardware co-simulation, allowing for the hardware to be used in a scripted test-bench or deployed as hardware acceleration in M-code. Apart from supporting the scheduling semantics of a System Generator simulation, M-Hwcosim also gives the flexibility for any arbitrary schedule to be used. This flexibility can be exploited to improve the performance of a simulation, if the user has apriori knowledge of how the design works. Additionally, the M-Hwcosim objects provide accessibility to the hardware from the MATLAB console, allowing for the hardware internal state to be introspected interactively.

## Compiling Hardware for Use with M-Hwcosim

Compiling hardware for use in M-Hwcosim follows the same flow as the typical System Generator hardware co-simulation flow. You start off with a System Generator model in Simulink, select a hardware co-simulation target in the System Generator token and click "Generate". At the end of the generation, a hardware co-simulation library is created.

Among other files in the netlist directory, a bit file and an hwc file can be found. The bit file corresponds to the FPGA implementation, and the hwc file contains information required for M-Hwcosim. Both bit file and hwc file are paired by name, e.g. mydesign\_cw.bit and mydesign\_cw.hwc.

The hwc file specifies additional meta information for describing the design and the chosen hardware co-simulation interface. With the meta information, a hardware co-simulation instance can be instantiated using M-Hwcosim, through which a user can interact with the co-simulation engine.

M-Hwcosim inherits the same concepts of ports, shared memories, and fixed point notations as found in the existing co-simulation block. Every design exposes its top-level ports and embedded shared memories for external access.

## M-Hwcosim Simulation Semantics

The simulation semantics for M-Hwcosim differs from that used during hardware co-simulation in a System Generator block diagram; the M-Hwcosim simulation semantics is more flexible and is capable of emulating the simulation semantics used in the block-based hardware co-simulation.

In the block-based hardware co-simulation, a rigid simulation semantic is imposed; before advancing a clock cycle, all the input ports of the hardware co-simulation are written to. Next all the output ports are read and the clock is advanced. In M-Hwcosim the scheduling of when ports are read or written to, is left to the user. For instance it would be possible to create a program that would only write data to certain ports on every other cycle, or to only read the outputs after a certain number of clock cycles. This flexibility allows users to optimize the transfer of data for better performance.

## Data Representation

M-Hwcosim uses fixed point data types internally, while it consumes and produces double precision floating point values to external entities. All data samples passing through a port or a memory location in a shared memory are fixed point numbers. Each sample has a preset data width and an implicit binary point position that are fixed at the compilation time. Data conversions (from double precision to fixed point) happen on the boundary of M-Hwcosim. In the current implementation, quantization of the input data is handled by rounding, and overflow is handled by saturation.

## Interfacing to Hardware from M-Code

When a model has been compiled for hardware co-simulation, the generated bitstream can be used in both a model-based Simulink flow, or in M-code executed in MATLAB. The general sequence of operations to access a bitstream in hardware typically follows the sequence described below.

1. Configure the hardware co-simulation interface. Note that the hardware co-simulation configuration is persistent and is saved in the hwc file. If the co-simulation interface is not changed, there is no need to re-run this step.
2. Create a M-Hwcosim instance for a particular design
3. Open the M-Hwcosim interface
4. Repeatedly run the following sub-steps until the simulation ends
  - a. Write simulation data to input ports
  - b. Read simulation data from output ports
  - c. Advance the design clock by one cycle
5. Close the M-Hwcosim interface
6. Release the M-Hwcosim instance

## M-Hwcosim Examples

### Tutorial Example: Using MATLAB Hardware Co-Simulation (M-Hwcosim)

The following step-by-step tutorial will show you how to perform MATLAB hardware co-simulation using a simple AddSub model that is comprised of two inputs and one output -- two operands (x1, x2) and one summation output (y).

**Note:** This step-by-step tutorial assumes that you have already installed and configured both the hardware and software required to run on an ML506 platform for Ethernet Hardware Co-Simulation. Refer to the topic **Installing an ML506 Platform for Ethernet Hardware Co-Simulation** for more information of how to install and configure this platform.

The AddSubExample design is located at the following pathname:

```
<ISE_Design_Suite_tree>/sysgen/examples/mhwcosim/AddSubExample.mdl
```

1. Open the model in MATLAB and observe the following blocks:

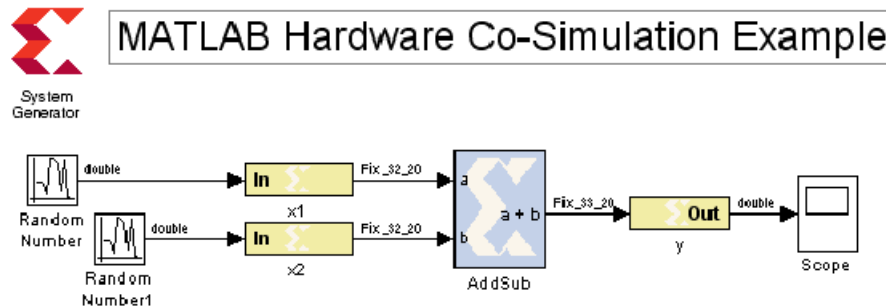

2. Double-click on the System Generator token to bring up the following dialog box.

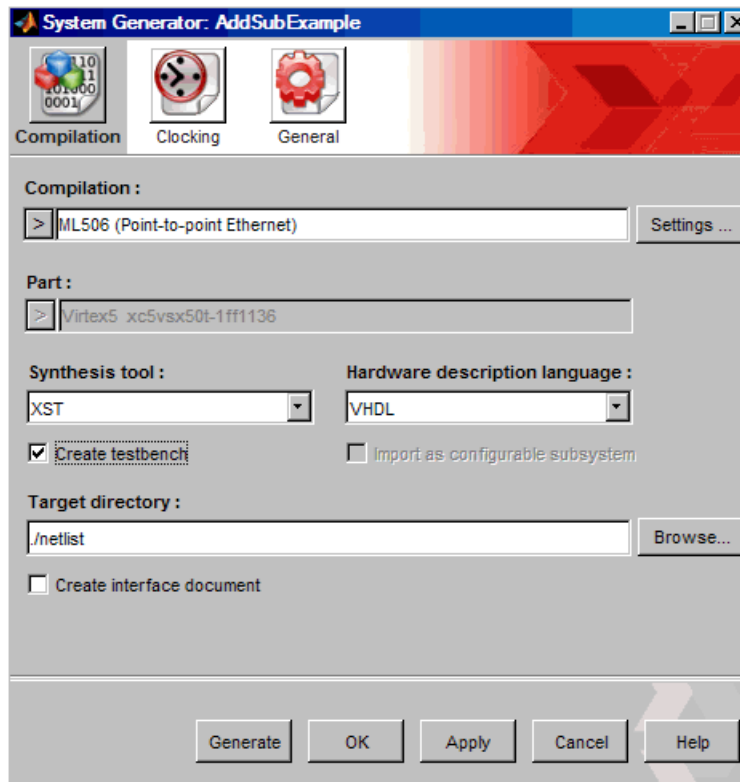

As shown above, the **Create testbench** checkbox is checked to tell the hardware co-simulation compilation flow to auto generate an M-code script `<design>_hwcosim_test.m` and golden test data files `<design>_<port>_hwcosim_test.dat` for each gateway based on the Simulink simulation. After a few moments, a sub-directory named `netlist` is created in the current working directory containing the generated files. For more information about the auto testbench generation, refer to the topic [Automatic Generation of M-Hwcosim Testbench](#).

3. Click **Generate** to begin generating the hardware co-simulation netlist. So far, the design flows are exactly the same as those for the Simulink hardware co-simulation.
4. Once netlist generation is complete, you are now ready to perform MATLAB Hardware Co-simulation. Run the provided M-code script at pathname `./examples/mhwcosim/AddSubExample/AddSubExample.mdl/mhwcosim.m` by either typing **mhwcosim** in the MATLAB console or right-clicking on the file and selecting the **Run** as shown below:

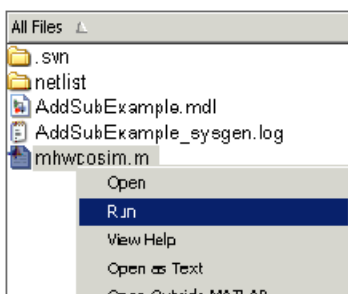

**Note:** This M-code script is created by slightly modifying the auto-generated M-code script to print out some simulation results.

5. The first time the model is simulated, you should see the following configuration dialog box pop up. Set parameters according to your computer and cable type as shown below and click OK.

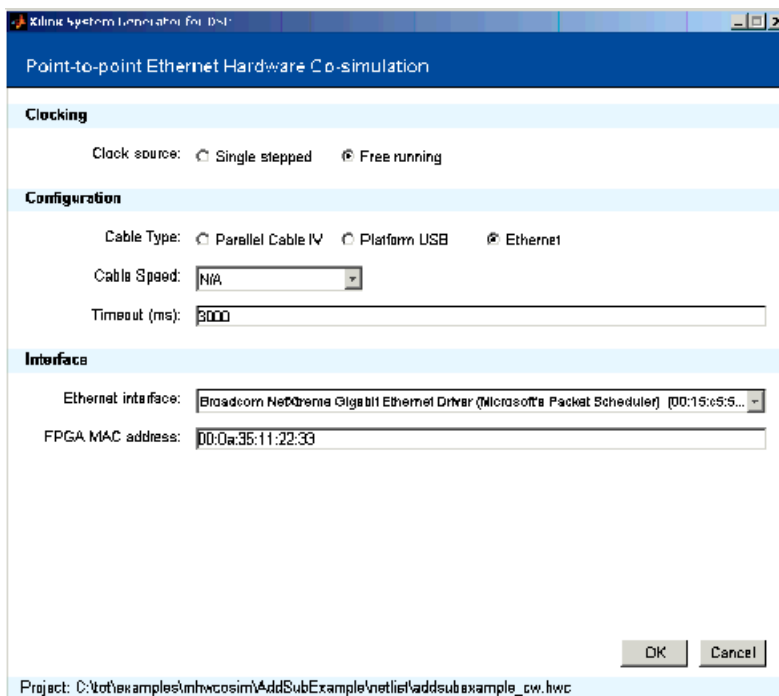



- After about 30 seconds, you should observe the simulation results in the MATLAB console as shown below:

Simulation OK

Cycle	Expected values	Actual values
0	2.3299064636230469	2.3299064636230469
1	3.3922843933105469	3.3922843933105469
2	-2.8923435211181641	-2.8923435211181641
3	-0.7200584411621094	-0.7200584411621094
4	-0.0897617340087891	-0.0897617340087891
5	1.0269565582275391	1.0269565582275391
6	0.7500820159912109	0.7500820159912109
7	-0.6458797454833984	-0.6458797454833984
8	1.6952972412109375	1.6952972412109375
9	-1.1141872406005859	-1.1141872406005859

### Summary

In addition to the Simulink hardware co-simulation, System Generator provides another methodology to perform hardware co-simulation by offering MATLAB hardware co-simulation. This feature enables you to programmatically control the hardware, created through the System Generator hardware co-simulation flow, using MATLAB M-code (M-Hwcosim). The M-Hwcosim interfaces allow for MATLAB objects that correspond to the hardware to be created in pure M-code, independent of the Simulink framework. These objects can then be used to read and write data into hardware. For more details on how to use Read and Write and other supported functions, refer to the topic [M-Hwcosim MATLAB Class](#).

This capability is also useful for providing a scripting interface to hardware co-simulation that allows the hardware to be used in a scripted test-bench or deployed as hardware acceleration in M-code. In certain design applications, you might find some improvement in performance using this method of hardware co-simulation.

## Example 2

This M-code uses an alternative form of syntax to perform the simulation described in the previous example. This form uses the `exec` instruction and provides better simulation performance by reducing the number of name-based lookups required to identify ports on a block, and also by folding the execution of code in an M-code for-loop into a single instruction, which reduces the over-head associated with interpreting the M-code.

```
% Configure the co-simulation interface. Note: This needs only to be
% done once, since the configuration is stored back into the hwc file
% This will launch a configuration GUI.
xlHwcosimConfig('mydesign.hwc');

% Define the number of simulation cycles.
nCycles = 1000;

% Creates a hardware co-simulation instance from the project
% 'mydesign.hwc'.
h = Hwcosim('mydesign.hwc');

% Opens and configures the hardware co-simulation interface.
open(h);

% Initializes the 'op' input port with a constant value zero.
write(h, 'op', 0);

% Initializes an execution definition that covers the input ports,
% x1 and x2, and the output ports y. It returns an execution
% identifier for use in subsequent exec instructions.
execId = initExec(h, {'x1', 'x2'}, {'y'});

% Simulate the design using the exec instruction.
% The input data are given as a 2-D matrix. Each row of the matrix
% gives the simulation data of an input port for all the cycles.
% For example, row i column j stores the data for the i-th port at
% (j-1)th cycle.
result = exec(h, execId, nCycles, rand(2, nCycles));

% Releases the hardware co-simulation instance.
% The hardware co-simulation interface is closed implicitly.
release(h);
```

### Example 3

This example shows how M-code is used to access Shared Memories in an M-Hwcosim flow. The example assumes that a System Generator model, with a Shared Memory called 'MyMem', and two SharedFifos called 'WriteFifo' and 'ReadFifo', has been compiled into a hardware co-simulation block.

**Note:** The model and source code for this example can be found at pathname  
<ISE\_Design\_Suite\_tree>/sysgen/examples/mhwcosim/ShMemExample

```
% Creates a hardware co-simulation instance from the project
'shmem.hwc'.
h = Hwcosim('shmem.hwc');

% Opens and configures the hardware co-simulation interface.
open(h);

% Creates a shared memory instance 'MyMem'. It connects the
corresponding
% shared memory running in hardware.
m = Shmem('MyMem');

% Creates a shared FIFO instance 'WriteFifo' for writing data to the
% hardware. Similarly, creates another shared FIFO instance 'ReadFifo'
for
% reading data from the hardware.
wf = Shfifo('WriteFifo');
rf = Shfifo('ReadFifo');

% Writes random numbers to memory address 0 to 49 of MyMem.
m(0:49) = rand(1, 50);

% Read the value at memory address 100 of MyMem.
y = m(100);

% Writes 10 random numbers to WriteFifo if it has 10 or more empty
space.
if wf.Available >= 10
    write(wf, 10, rand(1, 10));
end

% Reads 5 values from ReadFifo if it has 5 or more data.
if rf.Available >= 5
    d = read(rf, 5);
end

% Releases the shared memory instances.
release(m);
release(wf);
release(rf);

% Releases the hardware co-simulation instance.
release(h);
```

## Automatic Generation of M-Hwcosim Testbench

M-Hwcosim enables the testbench generation for hardware co-simulation. When the **Create testbench** option is checked in the System Generator GUI, the hardware co-simulation compilation flow generates an M-code script (<design>\_hwcosim\_test.m) and golden test data files (<design>\_<port>\_hwcosim\_test.dat) for each gateway based on the Simulink simulation. The M-code script uses the M-Hwcosim API to implement a testbench that simulates the design in hardware and verifies the results against the golden test data. Any simulation mismatch is reported in a result file (<design>\_hwcosim\_test.results).

As shown below in Example 4, the testbench code generated is easily readable and can be used as a basis for your own simulation code.

**Note:** The model for this example can be found at pathname <ISE\_Design\_Suite\_tree>/sysgen/examples/mhwcosim/MultiRatesExample

### Example 4

```
function multi_rates_cw_hwcosim_test
try
    % Define the number of hardware cycles for the simulation.
    ncycles = 10;

    % Load input and output test reference data.
    testdata_in2 = load('multi_rates_cw_in2_hwcosim_test.dat');
    testdata_in3 = load('multi_rates_cw_in3_hwcosim_test.dat');
    testdata_in7 = load('multi_rates_cw_in7_hwcosim_test.dat');
    testdata_pb00 = load('multi_rates_cw_pb00_hwcosim_test.dat');
    testdata_pb01 = load('multi_rates_cw_pb01_hwcosim_test.dat');
    testdata_pb02 = load('multi_rates_cw_pb02_hwcosim_test.dat');
    testdata_pb03 = load('multi_rates_cw_pb03_hwcosim_test.dat');
    testdata_pb04 = load('multi_rates_cw_pb04_hwcosim_test.dat');

    % Pre-allocate memory for test results.
    result_pb00 = zeros(size(testdata_pb00));
    result_pb01 = zeros(size(testdata_pb01));
    result_pb02 = zeros(size(testdata_pb02));
    result_pb03 = zeros(size(testdata_pb03));
    result_pb04 = zeros(size(testdata_pb04));

    % Initialize sample index counter for each sample period to be
    % scheduled.
    insp_2 = 1;
    insp_3 = 1;
    insp_7 = 1;
    outsp_1 = 1;
    outsp_2 = 1;
    outsp_3 = 1;
    outsp_7 = 1;

    % Define hardware co-simulation project file.
    project = 'multi_rates_cw.hwc';

    % Create a hardware co-simulation instance.
    h = Hwcosim(project);

    % Open the co-simulation interface and configure the hardware.
    try
        open(h);
```

```

catch
    % If an error occurs, launch the configuration GUI for the user
    % to change interface settings, and then retry the process again.
    release(h);
    xlHwcosimConfig(project, true);
    drawnow;
    h = Hwcosim(project);
    open(h);
end

% Simulate for the specified number of cycles.
for i = 0:(ncycles-1)

    % Write data to input ports based their sample period.
    if mod(i, 2) == 0
        h('in2') = testdata_in2(insp_2);
        insp_2 = insp_2 + 1;
    end
    if mod(i, 3) == 0
        h('in3') = testdata_in3(insp_3);
        insp_3 = insp_3 + 1;
    end
    if mod(i, 7) == 0
        h('in7') = testdata_in7(insp_7);
        insp_7 = insp_7 + 1;
    end

    % Read data from output ports based their sample period.
    result_pb00(outsp_1) = h('pb00');
    result_pb04(outsp_1) = h('pb04');
    outsp_1 = outsp_1 + 1;
    if mod(i, 2) == 0
        result_pb01(outsp_2) = h('pb01');
        outsp_2 = outsp_2 + 1;
    end
    if mod(i, 3) == 0
        result_pb02(outsp_3) = h('pb02');
        outsp_3 = outsp_3 + 1;
    end
    if mod(i, 7) == 0
        result_pb03(outsp_7) = h('pb03');
        outsp_7 = outsp_7 + 1;
    end

    % Advance the hardware clock for one cycle.
    run(h);

end

% Release the hardware co-simulation instance.
release(h);

% Check simulation result for each output port.
logfile = 'multi_rates_cw_hwcosim_test.results';
logfd = fopen(logfile, 'w');
sim_ok = true;
sim_ok = sim_ok & check_result(logfd, 'pb00', testdata_pb00,
result_pb00);

```

```

        sim_ok = sim_ok & check_result(logfd, 'pb01', testdata_pb01,
result_pb01);
        sim_ok = sim_ok & check_result(logfd, 'pb02', testdata_pb02,
result_pb02);
        sim_ok = sim_ok & check_result(logfd, 'pb03', testdata_pb03,
result_pb03);
        sim_ok = sim_ok & check_result(logfd, 'pb04', testdata_pb04,
result_pb04);
        fclose(logfd);
        if ~sim_ok
            error('Found errors in simulation results. Please refer to ''%s''
for details.', logfile);
        end

    catch
        err = lasterr;
        try release(h); end
        error('Error running hardware co-simulation testbench. %s', err);
    end

%-----

function ok = check_result(fd, portname, expected, actual)
    ok = false;

    fprintf(fd, ['\n' repmat('=', 1, 95), '\n']);
    fprintf(fd, 'Output: %s\n\n', portname);

    % Check the number of data values.
    nvals_expected = numel(expected);
    nvals_actual = numel(actual);
    if nvals_expected ~= nvals_actual
        fprintf(fd, ['The number of simulation output values (%d) differs '
...
                    'from the number of reference values (%d).\n'], ...
                    nvals_actual, nvals_expected);
    return;
end

% Check for simulation mismatches.
mismatches = find(expected ~= actual);
num_mismatches = numel(mismatches);
if num_mismatches > 0
    fprintf(fd, 'Number of simulation mismatches = %d\n',
num_mismatches);
    fprintf(fd, '\n');
    fprintf(fd, 'Simulation mismatches:\n');
    fprintf(fd, '-----\n');
    fprintf(fd, '%10s %40s %40s\n', 'Cycle', 'Expected values', 'Actual
values');
    fprintf(fd, '%10d %40.16f %40.16f\n', ...
[mismatches-1; expected(mismatches); actual(mismatches)]);
    return;
end

    ok = true;
    fprintf(fd, 'Simulation OK\n');

```

## Resource Management

M-Hwcosim manages resources that it holds for an hardware co-simulation instance. It releases the held resources upon the invocation of the release instruction or when MATLAB exits. However, it is recommended to perform an explicit cleanup of resources when the simulation finishes or throws an error. To allow proper cleanup in case of errors, it is suggested to enclose M-Hwcosim instructions in a MATLAB try-catch block as illustrated below.

```
try
    % M-Hwcosim instructions here
catch
    err = lasterror;
    % Release any Hwcosim, Shmem, or Shfifo instances
    try release(hwcosim_instance); end
    try release(shmem_instance); end
    try release(shfifo_instance); end
    rethrow(err);
end
```

The following commands can be used to release all hardware co-simulation or shared memory instances.

```
xlHwcosim('release');           % Release all Hwcosim instances
xlHwcosim('releaseMem');       % Release all Shmem instances
xlHwcosim('releaseFifo');     % Release all Shfifo instances
```

## M-Hwcosim MATLAB Class

### Hwcosim

The Hwcosim MATLAB class provides a higher level abstraction of the hardware co-simulation engine. Each instantiated Hwcosim object represents a hardware co-simulation instance. It encapsulates the properties, such as the unique identifier, associated with the instance. Most of the instruction invocations take the Hwcosim object as an input argument. For further convenience, alternative shorthand is provided for certain operations. Similarly, the Shmem and Shfifo class are provided for accessing shared memory and shared FIFO related operations, respectively.

Actions	Syntax
Constructor	<code>h = Hwcosim(project)</code>
Destructor	<code>release(h)</code>
Open hardware	<code>open(h)</code>
Close hardware	<code>close(h)</code>
Write data	<code>write(h, inPorts, inData)</code> <code>h(inPorts) = inData</code>
Read data	<code>outData = read(h, outPorts)</code> <code>outData = h(outPorts)</code>
Run	<code>run(h)</code> <code>run(h, n)</code>

Actions	Syntax
Vectorized Execution	<code>outData = exec(h, execId, nCycles, inData)</code>
Get properties	<code>data = get(h, prop)</code>

### Constructor

#### Syntax

```
h = Hwcosim(project);
```

#### Description

Creates an Hwcosim instance. Note that an instance is a reference to the hardware co-simulation project and does not signify an explicit link to hardware; creating a Hwcosim object informs the Hwcosim engine where to locate the FPGA bitstream, it does not download the bitstream into the FPGA. The bitstream is only downloaded to the hardware after an open command is issued.

The project argument should point to the hwc file that describes the hardware co-simulation.

### Destructor

#### Syntax

```
release(h);
```

#### Description

Releases the resources used by the Hwcosim object h. If a link to hardware is still open, release will first close the hardware.

### Open hardware

#### Syntax

```
open(h);
```

#### Description

Opens the connection between the host PC and the FPGA. Before this function can be called, the hardware co-simulation interface must be configured. Use the xIHwcosimConfig utility to configure the hardware co-simulation interface. The argument, h, is an Hwcosim object.

### Close hardware

#### Syntax

```
close(h);
```

#### Description

Closes the connection between the host PC and the FPGA. The argument, h, is an Hwcosim object.



## Write data

### Syntax

```
h('portName') = inData;  
h({inPortNames}) = [inData];  
h([inPortIndices]) = [inData];  
write(h, 'portName', inData);  
write(h, {inPortNames}, [inData]);  
write(h, [inPortIndices], [inData]);
```

### Description

Access to ports can be done by name or by index. Port names and indices can be extracted from an Hwcosim instance by getting the Inport property of the Hwcosim object. When ports are referred by name, a cell-array of port names is expected to be followed by an array of data that correspond to the ports. Similarly when ports are referred by index, an array of port indices is expected to be followed by an array of data.

**Note:** For a large number of read and write operations, specifying multiple ports by names is not encouraged for the sake of performance. It is recommended to resolve a sequence of port names into an equivalent index sequence using the get instruction, and then use the index sequence for subsequent read and write operations.

## Read data

### Syntax

```
outData = h('portName');  
[outData] = h({outPortNames});  
[outData] = h([outPortIndices]);  
outData = read(h, 'portName');  
[outData] = read(h, {outPortNames});  
[outData] = read(h, [outPortIndices]);
```

### Description

Access to ports can be done by name or by index. Port names and indices can be extracted from an Hwcosim instance by getting the Outport property of the Hwcosim object. When ports are referred by name, a cell-array of port names is expected to be followed by an array of data that correspond to the ports. Similarly when ports are referred by index, an array of port indices is expected to be followed by an array of data.

**Note:** For a large number of read and write operations, specifying multiple ports by names is not encouraged for the sake of performance. It is recommended to resolve a sequence of port names into an equivalent index sequence using the get instruction, and then use the index sequence for subsequent read and write operations.

## Run

### Syntax

```
run (h) ;
run (h, n) ;
```

### Description

When the hardware co-simulation object is configured to run in single-step mode, the run command is used to advance the clock. run(h) will advance the clock by one cycle. run(h,n) will advance the clock by n cycles.

When the hardware co-simulation object is configured to run in free-running mode, the run command has no effect on the clock of the hardware co-simulation. However in JTAG hardware co-simulation, write commands are buffered for efficiency reasons, and the run command can be used to flush the write buffer

**Note:** Currently the run command has no effect on Ethernet hardware co-simulation in free-running mode; but this behaviour might change in the future.

## Get properties

### Syntax

```
get (h) ;
getrun (h, prop) ;
```

### Description

Get returns the properties associated with the Hwcosim object h. The properties are returned as a MATLAB struct with the following fields.

prop	Description
Id	Internal use
Inport	A struct describing all the input ports
Output	A struct describing all the output ports
Execution	A struct describing the execution schedule
SharedMemory	A struct describing the available shared memories in the object

## Create Exec Id

### Syntax

```
execId = initExec (h, inPorts, outPorts) ;
getrun (h, prop) ;
```

### Description

The **exec** instruction is designed to minimize the overheads inherited in the MATLAB environment. It condenses a sequence of operations into a single invocation of the underlying hardware co-simulation engine, and thus reduces the overheads on interpreting M-codes, and switching between M-codes and the engine. It can provide a significant performance improvement on simulation, compared to using a repetitive sequence of individual **write**, **read**, and **run** instructions.

An execution definition is initialized using the **initExec** instruction, before subsequent executions of that definition can be invoked. Defining an execution is to specify which input and output ports involve in the execution. An execution can be defined on a subset of input and output ports. Only involved ports are read or written during the execution, while other input ports are expected to be driven by the same values, and other output ports are simply ignored.

The `inPorts` and `outPorts` argument in `initExec` can either be cell-arrays of portnames or arrays or port indexes.

**Note:** Having `initExec` and `exec` instructions separated is solely for performance concerns. The initialization phase is performed before subsequent executions so that it is only a one-time overhead. It is particularly important when we need to break down a simulation into multiple executions under certain circumstances, for example, when the memory cannot hold the input data for all simulation cycles.

An execution operates on a cycle basis, where input and output data are given on every cycle. In multi-rate designs, the internal operations are scheduled on a period of the GCD rate (the common sample period) of involved ports. The number of cycles is required to be a multiple of the LCM rate (the minimum execution length) of involved ports.

Special care is required when mixing the **exec** with individual **read**, **write**, and **run** instructions. Before an execution, the samplings of all involved input and output ports should be aligned on their common sample period boundary. In other words, it is expected to sample the involved ports at the first cycle of the execution. Provided this condition holds, the alignment of sampling is guaranteed for the involved ports when the execution completes, because the execution length is a multiple of the LCM rate.

The figure below illustrates an execution which involves two input ports operating at a sample period of 2 and 4 cycles respectively, and one output port with a sample period of 8 cycles. The common sample period is set to  $\text{GCD}(2,4,8) = 2$  cycles, which implies a sequence of write, read, and run operations is invoked on every 2 cycles starting from the first cycle of the execution. The minimum execution length is  $\text{LCM}(2,4,8) = 8$  cycles, and thus the execution must be run for a multiple of 8 cycles.

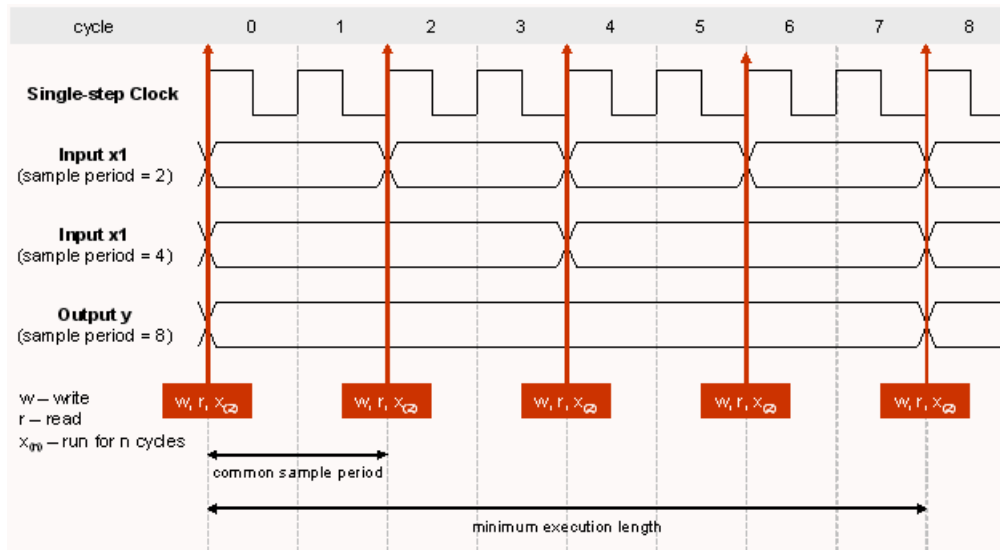

Vectorized execution

### Syntax

```
outData = exec(h, execId, nCycles, inData);
```

Description

The **exec** instruction is designed to minimize the overheads inherited in the MATLAB environment. It condenses a sequence of operations into a single invocation of the underlying engine, and thus reduces the overheads on interpreting M-codes, and switching between M-codes and the engine. It can provide a significant performance improvement on simulation, compared to using a repetitive sequence of individual **write**, **read**, and **run** instructions.

The `execId` argument is constructed through a call to `initExec`. `nCycles` specifies the number of simulation cycles to be run and `inData` contains the data used to drive the ports at each cycle. `inData` is a 2D matrix [M,N] where `length(M)` corresponds to the number of `inPorts` specified in `initExec`, and `length(n)` corresponds to the `nCycles`. All port data for the same execution cycle is stored in the same column. For example, the `[m,n]` element of the `inData` matrix corresponds to the (n-1)-th cycle data sample for the m-th input ports specified in the execution.

## M-Hwcosim Shared Memory MATLAB Class

### Shmem

The `Shmem` MATLAB class provides an interface into shared memories embedded in hardware co-simulation objects.

Actions	Syntax
Constructor	<code>m = Shmem(memName)</code>
Destructor	<code>release(m)</code>
Write data	<code>write(m, addresses, inData)</code> <code>m(addresses) = inData</code>
Read data	<code>outData = read(m, addresses)</code> <code>outData = m(addresses)</code>
Set properties	<code>set(m, prop, data)</code>
Get properties	<code>data = get(m, prop)</code>

### Constructor

#### Syntax

```
m = Shmem(memName);
```

Description

Creates an object handle to a Shared Memory or Shared Register object. The argument is the name of the shared memory as defined in the System Generator model. This is a global object and only one shared memory of a particular name can exist at a time.

### Destructor

#### Syntax

```
release(m);
```

Description

Releases the resources used by the Shmem object.

Write data

**Syntax**

```
write(m, addresses, inData);
```

```
m(addresses) = inData;
```

Description

When writing to a shared memory, addresses can be an integer or an array of integers specifying the address to write to.

When writing to a shared register, addresses should be set to 0.

Read data

**Syntax**

```
outData = read(m, addresses);
```

```
outData = m(addresses);
```

Description

When reading from a shared memory, addresses can be an integer or an array of integers specifying the address to read from.

When reading from a shared register, addresses should be set to 0.

Set properties

**Syntax**

```
set(m, prop, data);
```

Description

Used to set the properties of the Shmem object.

Get properties

**Syntax**

```
data=get(m);
```

```
data=get(m, prop);
```

Description

Used to get the properties of the Shmem object

## M-Hwcosim Shared FIFO MATLAB Class

### Shfifo

The Shfifo MATLAB class provides an interface into shared FIFOs embedded in hardware co-simulation objects.

Actions	Syntax
Constructor	<code>m = Shfifo(memName)</code>
Destructor	<code>release(m)</code>
Write data	<code>write(m, numValues, inData)</code>
Read data	<code>outData = read(m, numValues)</code>
Set properties	<code>set(m, prop, data)</code>
Get properties	<code>data = get(m, prop)</code>

#### Constructor

##### Syntax

```
m = Shfifo(fifoName);
```

##### Description

Creates an object handle to a Shared FIFO object. The argument is the name of the shared FIFO as defined in the System Generator model. This is a global object and only one shared memory of a particular name can exist at a time.

#### Destructor

##### Syntax

```
release(m);
```

##### Description

Releases the resources used by the Shfifo object.

#### Write data

##### Syntax

```
write(m, numValues, inData);
```

##### Description

When writing to a Shared FIFO, numValues is an integer that specifies the number of data to write into the FIFO. inData is an array where that data to be written is stored.

#### Read data

##### Syntax

```
outData = read(m, numValues);
```

##### Description

When reading to a Shared FIFO, numValues is an integer that specifies the number of data to read from the FIFO. outData is an array where that data read is stored.

Set properties

**Syntax**

```
set(m, prop, data);
```

Description

Used to set the properties of the Shfifo object.

Get properties

**Syntax**

```
data=get(m);
```

```
data=get(m, prop);
```

Description

Used to get the properties of the shfifo object, such as the full flag of the FIFO.

## M-Hwcosim Utility Functions

### xlHwcosim

Syntax

```
xlHwcosim('release');
```

```
xlHwcosim('releaseMem');
```

```
xlHwcosim('releaseFifo');
```

Description

When a M-Hwcosim, Shared Memory or Shared FIFO objects are created global system resources are used to register each of these objects. These objects are typically freed when a release command is called on the object. xlHwcosim provides an easy way to release all resources used by M-Hwcosim in the event of an unexpected error. The release functions for each of the objects should be used if possible since the xlHwcosim call release the resources for all instances of a particular type of object.

```
xlHwcosim('release') release all instances of Hwcosim objects.
```

```
xlHwcosim('releaseMem') release all instances of Shmem objects
```

```
xlHwcosim('releaseFifo'); release all instances of Shfifo objects
```

### xlHwcosimConfig

Syntax

```
xlHwcosimGetDesignInfo;
```

```
xlHwcosimGetDesignInfo('netlist')
```

```
xlHwcosimGetDesignInfo('c:/design/macfir_cw.hwc')
```

Description

xlHwcosimConfig launches a graphical front-end (shown below) to configure the settings of the Hardware Co-simulation interface. It is equivalent to the block GUI launched by double clicking a

Hardware Co-simulation block in Simulink. Its invocation is similar to `xlHwcosimGetDesignInfo`.

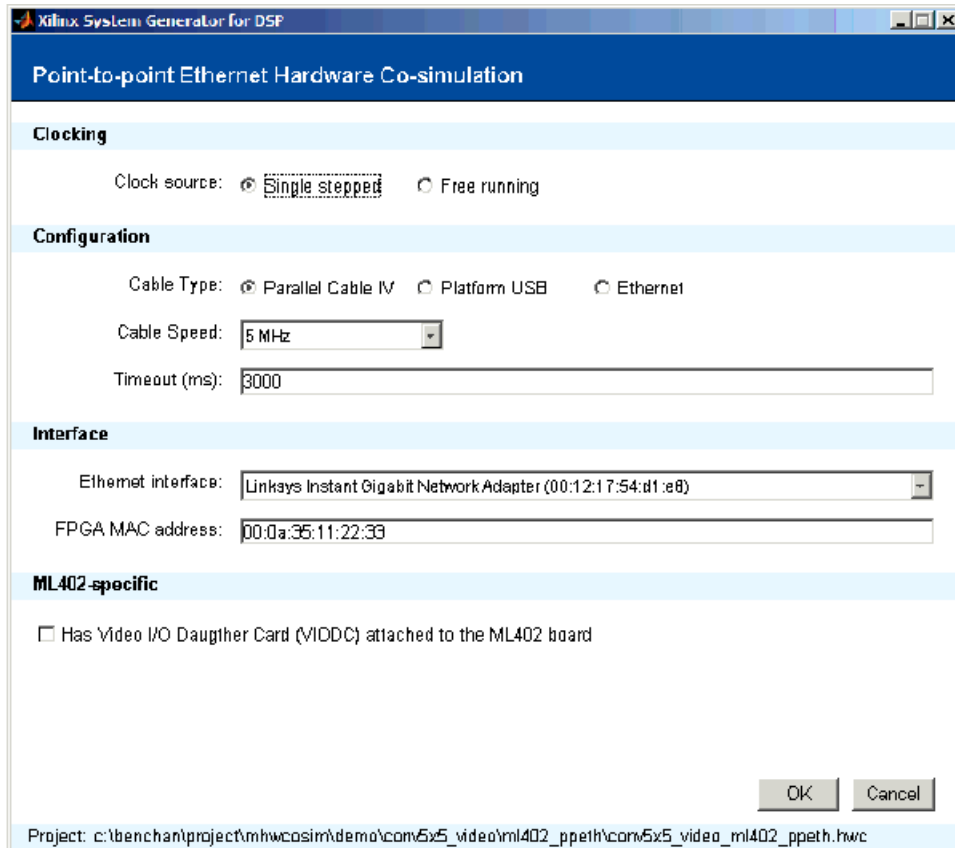

## `xlHwcosimGetDesignInfo`

### Syntax

```
xlHwcosimGetDesignInfo;
xlHwcosimGetDesignInfo('netlist')
xlHwcosimGetDesignInfo('c:/design/macfir_cw.hwc')
```

### Description

`xlHwcosimGetDesignInfo` is used to retrieve the information of a design in a hwc file. By default, it takes a hwc file as input, and returns the design information in a MATLAB struct array. If no hwc file is specified, it searches for the project file in the current directory. If a directory is provided it searches for a hwc file in the given directory.



## xlHwcosimSimulate

### Syntax

```
outData = xlHwcosimSimulate(project, nCycles, inData)
[o1, o2, ...] = xlHwcosimSimulate(project, nCycles, i1, i2, ...)
outData = xlHwcosimSimulate(project, nCycles, struct('Inport',
inPorts, 'Outport', outPorts, inData)
```

### Description

xlHwcosimSimulate provides a one-liner function call to simulate a design with predefined input values. The simulation is done on a cycle basis. The function takes a sequence of data values, one for each input port on each cycle, and returns a sequence of results, one for each output port on each cycle. By default, all input and output ports are involved, and data values are mapped to ports in the ascending order of port indices.

xlHwcosimSimulate is good for simplicity and fits for common simulation purposes, but is limited in several aspects:

- No user-defined simulation semantics
- All simulation cycles are executed as a whole, for example, cannot set a breakpoint in a simulation cycle
- No shared memory access



# Index

## Numerics

- 2 Channel Decimate by 2 MAC FIR Filter Reference Design 463
- 2n+1-tap Linear Phase MAC FIR Filter Reference Design 464
- 2n-tap Linear Phase MAC FIR Filter Reference Design 465
- 2n-tap MAC FIR Filter Reference Design 466
- 2Registered Mealy State Machine Reference Design 502
- 4-channel 8-tap Transpose FIR Filter Reference Design 467
- 4n-tap MAC FIR Filter Reference Design 468
- 5x5Filter Reference Design 469

## A

- Absolute block 52
- Accumulator block 54
- Addressable Shift Register block 56
- AddSub block 58
- Assert block 60
- AXI FIFO block 63

## B

- Basic Element Blocks 21, 22
- BitBasher block 66
- Black Box block 69
- Block Color
  - meaning of block background color 20
- Block Parameters
  - common options 47
- Block Upgrading
  - upgrading to the latest revision 406
- Blockset Libraries
  - organization of 20
- BPSK AWGN Channel Reference Design 471

## C

- ChipScope block 77
- ChipScope Pro Analyzer
  - hardware and software requirements 77
  - importing data into MATLAB Workspace 78
  - known issues 79
  - project file 78

- CIC Compiler 2.0 block 80
- CIC Compiler 3.0 block 82
- CIC Filter Reference Design 472
- Clock Enable Probe block 85
- Clock Probe block 87
- Clocking Options
  - Expose Clock Ports 408
  - Hybrid DCM-CE 408
- CMult block 88
- Color
  - meaning of block background color 20
- Common Options
  - block parameters 47
- Communication Blocks 24
- Compiling for
  - M-Hwcosim 581
- Complex Multiplier 3.1 block 90
- Complex Multiplier 5.0 block 92
- Concat block 97
- Configurable Subsystem Manager block 98
- Constant block 100
- Control Logic blocks 25
- Convert block 103
- Convolution Encoder 7.0 block 105
- Convolution Encoder 8.0 block 107
- Convoluntional Encoder Reference Design 474
- CORDIC 4.0 block 109
- CORDIC 5.0 block 112
- CORDIC ATAN Reference Design 476
- CORDIC DIVIDER Reference Design 477
- CORDIC LOG Reference Design 478
- CORDIC SINCOS Reference Design 480
- CORDIC SQRT Reference Design 481
- Counter block 117

## D

- Data Type blocks 27
- DCM locked pin 408
- DCM reset pin 408
- DDS Compiler 4.0 block 119
- DDS Compiler 5.0 block 124
- Delay block 131
- Depuncture block 137
- Disregard Subsystem block 139
- Divide block 140
- Divider Generator 3.0 block 142

- Divider Generator 4.0 block 144
- Down Sample block 147
- DSP Blocks 28
- DSP48 block 150
- DSP48 macro 2.0 block 162
- DSP48 Macro 2.1 block 167
- DSP48 Macro block 153
- DSP48A block 172
- DSP48E block 175
- DSP48E1 block 180
- Dual Port Memory Interpolation MAC FIR Filter Reference Design 483
- Dual Port RAM block 185

## E

- EDK Processor block 191
- Examples
  - M-Hwcosim 583
- Expression block 195

## F

- Fast Fourier Transform 7.1 block 196
- Fast Fourier Transform 8.0 block 202
- FDATool block 209
- FIFO block 210
- FIR Compiler 5.0 block 212
- FIR Compiler 6.2 block 219
- FIR Compiler 6.3 block 228
- Floating-Point Blocks 30
  - for 581
- From FIFO block 237
- From Register block 240

## G

- Gateway In block 242
- Gateway Out block 244

## H

- Hardware Co-Sim
  - M-code access to 580
- Hardware Co-Simulation
  - M-code access to 580

## I

Indeterminate Probe block 246  
 Index Blocks 32  
 Interleaver Deinterleaver 6.0 block 247  
 Interleaver Deinterleaver 7.0 block 258  
 Interleaver Deinterleaver 7.1 block 267  
 Interpolation Filter Reference Design 484  
 Inverter block 276

## J

JTAG Co-Simulation block 277

## L

LFSR block 280  
 Logical block 282

## M

Math blocks 41  
 MATLAB Class  
     Hwcosim 591  
     Shfifo 598  
     Shmem 596  
 m-channel n-tap Transpose FIR Filter Reference Design 485  
 M-Code  
     access to Hardware Co-Sim 580  
     interfacing to hardware 582  
 MCode block 283  
 Mealy State Machine Reference Design 486  
 Memory blocks 43  
 Memory Map View  
     EDK Processor Block 192  
 Memory Stitching  
     From Register block 240  
     Shared Memory block 385  
     To Register block 418  
 M-Hwcosim  
     automatic generation of testbench 588  
     compiling hardware for 581  
     data representation 582  
     examples 583  
     MATLAB class 591  
     shared FIFO MATLAB class 598  
     shared memory MATLAB Class 596  
     simulation semantics 581  
     utility functions 599  
 Model Upgrade

upgrading blocks to the latest revision 406

ModelSim block 305  
 Moore State Machine Reference Design 490  
 Mult block 310  
 Multipath Fading Channel Model Reference Design 493  
 Multiple Subsystem Generator block 312  
 Mux block 317

## N

Natural Logarithm block 319  
 Negate block 320  
 Network Ethernet Co-simulation block 321  
 n-tap Dual Port Memory MAC FIR Filter Reference Design 500  
 n-tap MAC FIR Filter Reference Design 501

## O

Opmode block 323

## P

Parallel to Serial block 332  
 Parameters  
     common options 47  
 Pause Simulation block 333  
 PG API 567  
     Error/Warning Messages 579  
     Introduction 567  
     xBlock 568  
     xBlockHelp 572  
     xInput 569  
     xsub2script 570  
     xOutput 569  
     xSignal 570  
 PG API Examples  
     Hello World 573  
     MACC 574  
     MACC in a Masked Sybssystem 575  
 PicoBlaze Instruction Display block 334  
 PicoBlaze Microcontroller block 335  
 PicoBlaze6 Instruction Display block 337  
 PicoBlaze6 Microcontroller block 338  
 Pipelining  
     saturation and rounding logic multipliers 310  
 PLB v4.6 Support  
     EDK Processor Block 193

Setting the Base Memory Space Address 193

Point-to-Point Ethernet Co-Simulation block 342  
 Programmatic Generation  
     of System Generator block diagrams 567  
 Puncture block 345

## R

Reciprocal block 346  
 Reciprocal SquareRoot block 347  
 Reed-Solomon Decoder 7.1 block 348  
 Reed-Solomon Decoder 8.0 block 353  
 Reed-Solomon Encoder 7.1 block 359  
 Reed-Solomon Encoder 8.0 block 364  
 Register block 369, 381  
 Registered Moore State Machine Reference Design 505  
 Reinterpret block 370  
 Relational block 372  
 Reset Generator block 373  
 Resource Estimator block 374  
 ROM block 378  
 Rounding logic  
     pipelining 310

## S

Sample Time block 382  
 Saturation Logic  
     pipelining 310  
 Scale block 383  
 Serial to Parallel block 384  
 Shared Memory block 385  
 Shared Memory blocks 44  
 Shared Memory Read block 389  
 Shared Memory Stitching  
     From Register block 240  
     Shared Memory block 385  
     To Register block 418  
 Shared Memory Write block 391  
 Shift block 393  
 Simulation Multiplexer block 394  
 Simulink Blocks  
     supported by System Generator 46  
 Single Port RAM block 396  
 Single-Step Simulation block 401  
 Slice block 402  
 SquareRoot block 403  
 Synchronous Clocking

- Expose Clock Ports option 408
- Hybrid DCM-CE option 408
- System Generator GUI Utilities
  - Xilinx BlockAdd 558, 561
  - Xilinx Tools > Save as blockAdd default 560
- System Generator token 404
- System Generator Utilities
  - xlAddTerms 523
  - xlCache 526
  - xlconfiguresolver 528
  - xlfd denominator 529
  - xlfd numerator 530
  - xlGenerateButton 531
  - xlgetParam 532, 534
  - xlGetReloadOrder 536
  - xlInstallPlugin 538
  - xlLoadChipScopeData 539
  - xlSBDBuilder 540
  - xlSetNonMemMap 543
  - xlsetparam 532
  - xlSetUseHDL 544
  - xlSwitchLibrary 545
  - xlTBUtills 546
  - xlTimingAnalysis 550
  - xlUpdateModel 551
  - xlVDMACreateProject 554
  - xlVersion 555

## T

- Threshold block 411
- Time Division Demultiplexer block 412
- Time Division Multiplexer block 414
- To FIFO block 415
- To Register block 418
- Tool Blocks 44
- Toolbar block 421
- Tutorials
  - M-Hwcosim
    - Using MATLAB Hardware Co-Simulation 583

## U

- UG638 (v 14.1) April 24, 2012 1
- Up Sample block 423
- Utility Functions
  - for M-Hwcosim 599

## V

- VDMA Interface 4.0 block 425
- VDMA Interface 5.4 block 433
- Virtex Line Buffer (Imaging) Reference Design 508
- Virtex2 5 Line Buffer (Imaging) Reference Design 510
- Virtex2 Line Buffer (Imaging) Reference Design 509
- Viterbi Decoder 7.0 block 437
- Viterbi Decoder 8.0 block 443

## W

- WaveScope block 450
- White Gaussian Noise Generator (Communication) Reference Design 511

## X

- xBlock 568
- Xilinx Block Libraries
  - Basic Element blocks 21, 22
  - Communication blocks 24
  - Control Logic blocks 25
  - Data Type blocks 27
  - DSP blocks 28
  - Floating-Point blocks 30
  - Index blocks 32
  - Math blocks 41
  - Memory blocks 43
  - Shared Memory blocks 44
  - Tool blocks 44
- Xilinx BlockAdd 558, 561
- Xilinx Blockset
  - Absolute 52
  - Accumulator 54
  - Addressable Shift Register 56
  - AddSub 58
  - Assert 60
  - AXI FIFO 63
  - BitBasher 66
  - Black Box 69
  - ChipScope 77
  - CIC Compiler 2.0 80
  - CIC Compiler 3.0 82
  - Clock Enable Probe 85
  - Clock Probe 87
  - CMult 88
  - Complex Multiplier 3.1 90
  - Complex Multiplier 5.0 92
  - Concat 97

- Configurable Subsystem Manager 98
- Constant 100
- Convert 103
- Convolution Encoder 7.0 105
- Convolution Encoder 8.0 107
- CORDIC 4.0 109
- CORDIC 5.0 112
- Counter 117
- DDS Compiler 4.0 119
- DDS Compiler 5.0 124
- Delay 131
- Depuncture 137
- Disregard Subsystem 139
- Divide 140
- Divider Generator 3.0 142
- Divider Generator 4.0 144
- Down Sample 147
- DSP48 150
- DSP48 Macro 153
- DSP48 macro 2.0 162
- DSP48 Macro 2.1 167
- DSP48A 172
- DSP48E 175
- DSP48E1 180
- Dual Port RAM 185
- EDK Processor 191
- Expression 195
- Fast Fourier Transform 7.1 196
- Fast Fourier Transform 8.0 202
- FDATool 209
- FIFO 210
- FIR Compiler 5.0 212
- FIR Compiler 6.2 219
- FIR Compiler 6.3 228
- From FIFO 237
- From Register 240
- Gateway In 242
- Gateway Out 244
- Indeterminate Probe 246
- Interleaver Deinterleaver 6.0 247
- Interleaver Deinterleaver 7.0 258
- Interleaver Deinterleaver 7.1 267
- Inverter 276
- JTAG Co-Simulation 277
- LFSR 280
- Logical 282
- MCode 283
- ModelSim 305
- Mult 310
- Multiple Subsystem Generator 312
- Mux 317
- Negate 320

- Network Ethernet Co-simulation 321
- Opmode 323
- Parallel to Serial 332
- Pause Simulation 333
- PicoBlaze Instruction Display 334
- PicoBlaze Microcontroller 335
- PicoBlaze6 Instruction Display 337
- PicoBlaze6 Microcontroller 338
- Point-to-Point Ethernet Co-Simulation 342
- Puncture 345
- Reciprocal 346
- Reciprocal SquareRoot 347
- Reed-Solomon Decoder 7.1 348
- Reed-Solomon Decoder 8.0 353
- Reed-Solomon Encoder 7.1 359
- Reed-Solomon Encoder 8.0 364
- Register 369, 381
- Reinterpret 370
- Relational 372
- Reset Generator 373
- Resource Estimator 374
- ROM 378
- Sample Time 382
- Scale 383
- Serial to Parallel 384
- Shared Memory 385
- Shared Memory Read 389
- Shared Memory Write 391
- Shift 393
- Simulation Multiplexer 394
- Single Port RAM 396
- Single-Step Simulation 401
- Slice 402
- SquareRoot 403
- System Generator 404
- Threshold 411
- Time Division Demultiplexer 412
- Time Division Multiplexer 414
- To FIFO 415
- To Register 418
- Toolbar 421
- Up Sample 423
- VDMA Interface 4.0 425
- VDMA Interface 5.4 433
- Viterbi Decoder 7.0 437
- Viterbi Decoder 8.0 443
- WaveScope 450
- XtremeDSP Analog to Digital Converter 514
- XtremeDSP Co-Simulation 515
- XtremeDSP Digital to Analog Converter 517
- XtremeDSP External RAM 518
- XtremeDSP LED Flasher 519
- Xilinx Blockset Libraries
  - organization of blocks 20
- Xilinx Blockset Natural Logarithm 319
- Xilinx Reference Design Library
  - 2 Channel Decimate by 2 MAC FIR Filter 463
  - 2n+1-tap Linear Phase MAC FIR Filter 464
  - 2n-tap Linear Phase MAC FIR Filter 465
  - 2n-tap MAC FIR Filter 466
  - 4-channel 8-tap Transpose FIR Filter 467
  - 4n-tap MAC FIR Filter 468
  - 5x5Filter 469
  - BPSK AWGN Channel 471
  - CIC Filter 472
  - Communication Designs 461
  - Control Logic Designs 461
  - Convolutional Encoder 474
  - CORDIC ATAN 476
  - CORDIC DIVIDER 477
  - CORDIC LOG 478
  - CORDIC SINCOS 480
  - CORDIC SQRT 481
  - DSP Designs 461
  - Dual Port Memory Interpolation MAC FIR Filter 483
  - Imaging Designs 462
  - Interpolation Filter 484
  - Math Designs 462
  - m-channel n-tap Transpose FIR Filter 485
  - Mealy State Machine 486
  - Moore State Machine 490
  - Multipath Fading Channel Model 493
  - n-tap Dual Port Memory MAC FIR Filter 500
  - n-tap MAC FIR Filter 501
  - Registered Mealy State Machine 502
  - Registered Moore State Machine 505
  - Virtex Line Buffer (Imaging) 508
  - Virtex2 5 Line Buffer (Imaging) 510
  - Virtex2 Line Buffer (Imaging) 509
  - White Gaussian Noise Generator (Communication) 511
- Xilinx Tools > Save as blockAdd default 560
- xInput 569
- xlAddTerms 523
- xlBlockHelp 572
- xlCache 526
- xlconfiguresolver 528
- xlfd\_a\_denominator 529
- xlfd\_a\_numerator 530
- xlGenerateButton 531
- xlgetParam 532, 534
- xlGetReloadOrder 536
- xlInstallPlugin 538
- xlLoadChipScopeData 539
- xlSBDBuilder 540
- xlSetNonMemMap 543
- xlsetparam 532
- xlSetUseHDL 544
- xlsub2script 570
- xlSwitchLibrary 545
- xlTBUtils 546
- xlTimingAnalysis 550
- xlUpdateModel 551
- xlVDMACreateProject 554
- xlVersion 555
- xOutput 569
- xSignal 570
- XtremeDSP Analog to Digital Converter block 514
- XtremeDSP Co-Simulation block 515
- XtremeDSP Digital to Analog Converter block 517
- XtremeDSP External RAM block 518
- XtremeDSP LED Flasher block 519