

Vivado Design Suite Tutorial

Implementation

UG986 (v2019.1) June 24, 2019



Revision History

The following table shows the revision history for this document.

Section	Revision Summary
06/24/2019 Version 2019.1	
<ul style="list-style-type: none">• <i>Figure 35: Design Runs Window after Completion</i>• <i>Figure 37: Incremental Reuse Report</i>• <i>Figure 45: Vivado IDE Showing project_bft_core Project Details</i>	Figure updates.

Table of Contents

Revision History	2
Implementation Tutorial	5
Overview	5
Tutorial Design Description.....	6
Hardware and Software Requirements.....	6
Preparing the Tutorial Design Files	6
Locating Design Files for Labs 1-3.....	6
Locating Design Files for Lab 4	7
Lab 1: Using Implementation Strategies.....	8
Introduction	8
Step 1: Opening the Example Project.....	8
Step 2: Creating Additional Implementation Runs.....	14
Step 3: Analyzing Implementation Results.....	15
Step 4: Tightening Timing Requirements	18
Conclusion	20
Lab 2: Using Incremental Implementation.....	21
Introduction	21
Step 1: Opening the Example Project.....	21
Step 2: Viewing the Incremental Heading in the Design Runs Window	27
Step 3: Turning on Incremental Implementation.....	28
Step 4: Compiling the Reference Design	30
Step 5: Making Incremental Changes	31
Step 6: Rerunning the Synthesis and Implementation	33
Conclusion	36
Lab 3: Manual and Directed Routing	37
Introduction	37
Step 1: Opening the Example Project.....	37
Step 2: Performing Place and Route on the Design	44
Step 3: Analyzing Output Bus Timing	46

Step 4: Improving Bus Timing through Placement	53
Step 5: Using Manual Routing to Reduce Clock Skew.....	59
Step 6: Copying Routing to Other Nets	70
Conclusion	74
Lab 4: Vivado ECO Flow.....	75
Introduction	75
Step 1: Creating a Project Using the Vivado New Project Wizard.....	77
Step 2: Synthesizing, Implementing, and Generating the Bitstream.....	79
Step 3: Validating the Design on the Board	80
Step 4: Making the ECO Modifications.....	88
Step 5: Implementing the ECO Changes.....	104
Step 6: Replacing Debug Probes.....	109
Conclusion	113
Legal Notices.....	114
Please Read: Important Legal Notices	114



IMPORTANT: This tutorial requires the use of the Kintex[®]-7 and Kintex UltraScale[™] family of devices. You will need to update your Vivado[®] Design Suite tools installation if you do not have this device family installed. Refer to the Vivado Design Suite User Guide: Release Notes, Installation, and Licensing (UG973) for more information on Adding Design Tools or Devices.

Overview

This tutorial includes four labs that demonstrate different features of the Xilinx[®] Vivado[®] Design Suite implementation tool:

- [Lab 1](#) demonstrates using implementation strategies to meet different design objectives.
- [Lab 2](#) demonstrates the use of the incremental compile feature after making a small design change.
- [Lab 3](#) demonstrates the use of manual placement and routing, and duplicated routing, to fine-tune the timing on the design.
- [Lab 4](#) demonstrates the use of the Vivado ECO to make quick changes to your design post implementation.

Vivado implementation includes all steps necessary to place and route the netlist onto the FPGA device resources, while meeting the logical, physical, and timing constraints of a design.



VIDEO: You can also learn more about implementing the design by viewing the following Quick Take videos:

- [Vivado Quick Take Video: Implementing the Design](#)
- [Vivado Quick Take Video: Using Incremental Implementation in Vivado](#)

TRAINING: Xilinx provides training courses that can help you learn more about the concepts presented in this document. Use these links to explore related courses:



- [Designing FPGAs Using the Vivado Design Suite 1](#)
 - [Designing FPGAs Using the Vivado Design Suite 2](#)
 - [Designing FPGAs Using the Vivado Design Suite 3](#)
 - [Designing FPGAs Using the Vivado Design Suite 4](#)
-

Tutorial Design Description

The design used for Lab #1 is the CPU Netlist example design, `project_cpu_netlist_kintex7`, provided with the Vivado Design Suite installation. This design uses a top-level EDIF netlist source file, and an XDC constraints file.

The design used for Lab #2 and Lab #3 is the BFT Core example design, `project_bft_kintex7`. This design includes both Verilog and VHDL RTL files, as well as an XDC constraints file.

The design used for Lab #4 is available as a Reference Design from the Xilinx website. See information in [Locating Design Files for Lab 4](#).

The CPU Netlist and BFT Core designs target an XC7K70T device, and the design for Lab #4 targets an XCKU040 device. Running the tutorial with small designs allows for minimal hardware requirements and enables timely completion of the tutorial, as well as minimizing data size.

Hardware and Software Requirements

This tutorial requires that the 2019.1 Vivado Design Suite software release or later is installed.

Refer to the *Vivado Design Suite User Guide: Release Notes, Installation, and Licensing* ([UG973](#)) for a complete list and description of the system and software requirements.

Preparing the Tutorial Design Files

Locating Design Files for Labs 1-3

You can find the files for Labs 1-3 in this tutorial in the Vivado Design Suite examples directory at the following location:

```
<Vivado_install_area>/Vivado/<version>/examples/Vivado_Tutorial
```

You can also extract the provided zip file, at any time, to write the tutorial files to your local directory, or to restore the files to their starting condition.

Extract the zip file contents from the software installation into any write-accessible location.

```
<Vivado_install_area>/Vivado/<version>/examples/Vivado_Tutorial.zip
```

The extracted `Vivado_Tutorial` directory is referred to as `<Extract_Dir>` in this tutorial.

Note: *You will modify the tutorial design data while working through this tutorial. You should use a new copy of the original `Vivado_Tutorial` directory each time you start this tutorial.*

Locating Design Files for Lab 4

To access the reference design for Lab #4, do the following:

1. In your C: drive, create a folder called /Vivado_Tutorial.
2. Download the [reference design files](#) from the Xilinx website.
3. Unzip the tutorial source file to the /Vivado_Tutorial folder.

Introduction

In this lab, you will learn how to use implementation strategies with design runs by creating multiple implementation runs employing different strategies, and comparing the results. You will use the CPU Netlist example design that is included in the Vivado® IDE.

Step 1: Opening the Example Project

1. Open the Xilinx® Vivado IDE.

On Linux:

- a. Change to the directory where the lab materials are stored:

```
cd <Extract_Dir>/Vivado_Tutorial
```

- b. Launch the Vivado IDE: `vivado`

On Windows:

- a. To launch the Vivado IDE, select:

Start > All Programs > Xilinx Design Tools > Vivado 2019.x > Vivado 2019.x

Note: Your Vivado Design Suite installation might be called something other than **Xilinx Design Tools** on the **Start** menu.

Note: As an alternative, click the **Vivado 2019.x** Desktop icon to start the Vivado IDE.

The Vivado IDE Getting Started page contains links to open or create projects and to view documentation.

2. From the Getting Started page, click **Open Example Project**.

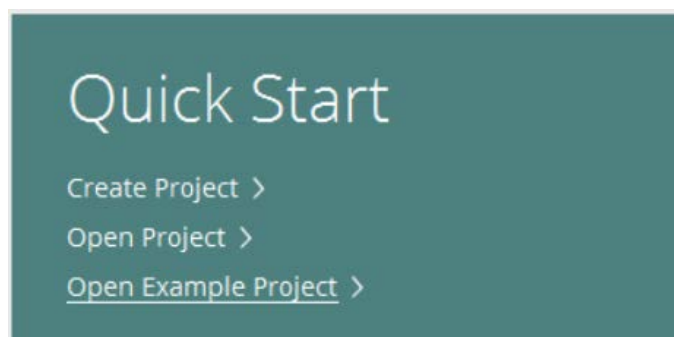

Figure 1: Open Example Project

4. In the Create an Example Project screen, click **Next**.

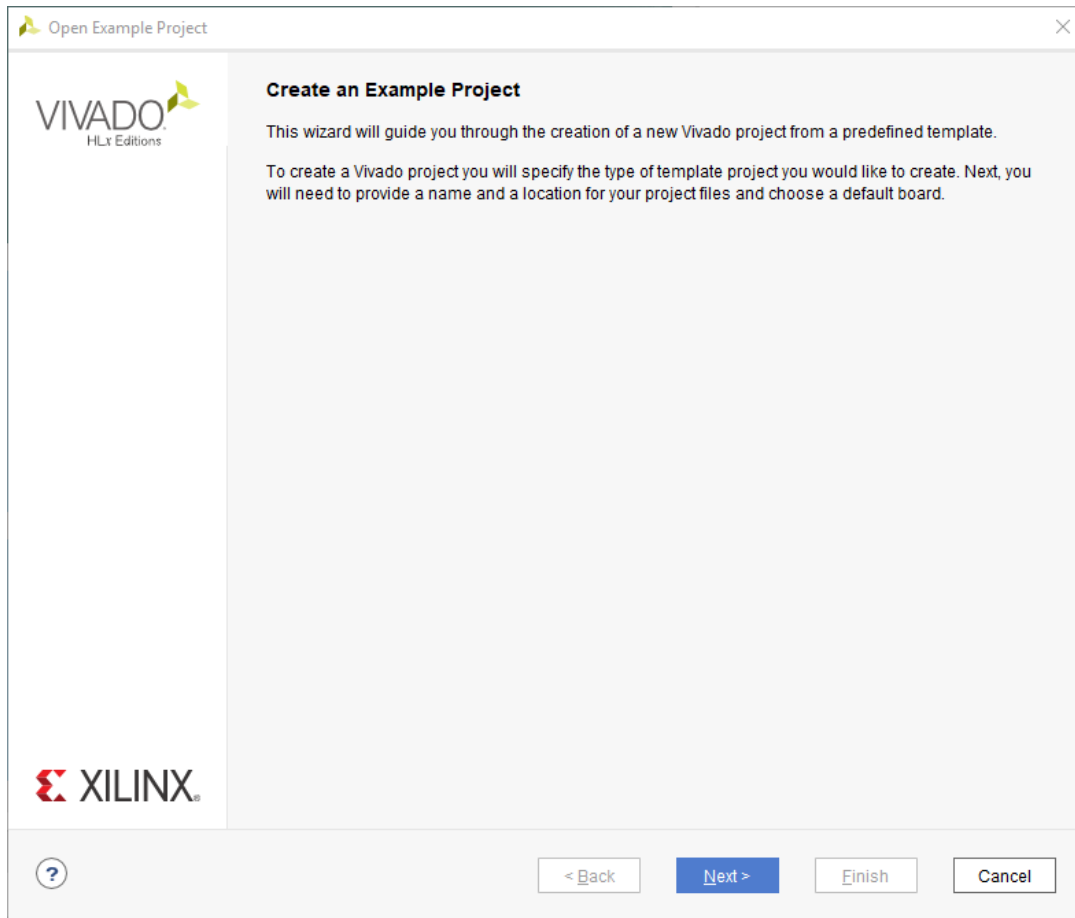

Figure 2: Open Example Project Wizard—Create an Example Project Screen

5. In the Select Project Template screen, choose the **CPU (Synthesized)** project and click **Next**.

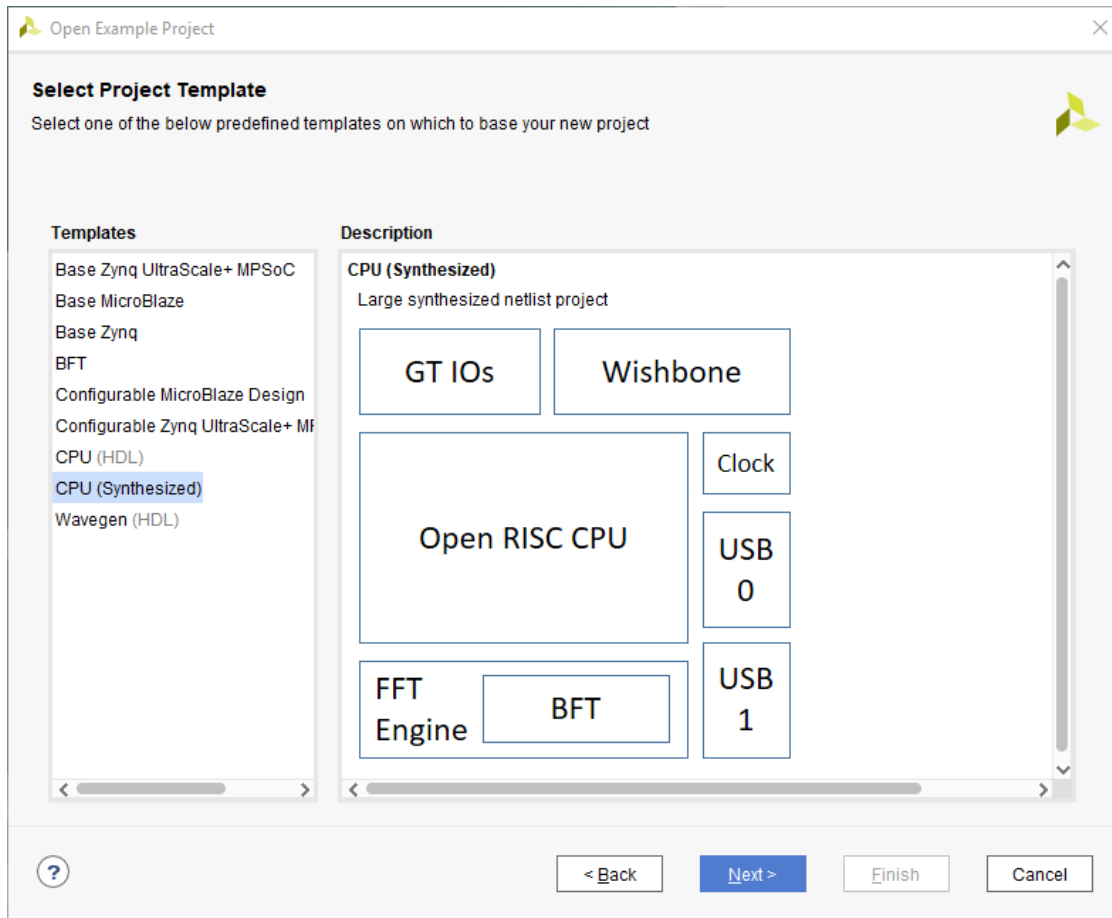

Figure 3: Open Example Project Wizard—Select Project Template Screen

6. In the Project Name screen, specify the following, and click **Next**:
- o Project name: **project_cpu_netlist**
 - o Project location: <Project_Dir>

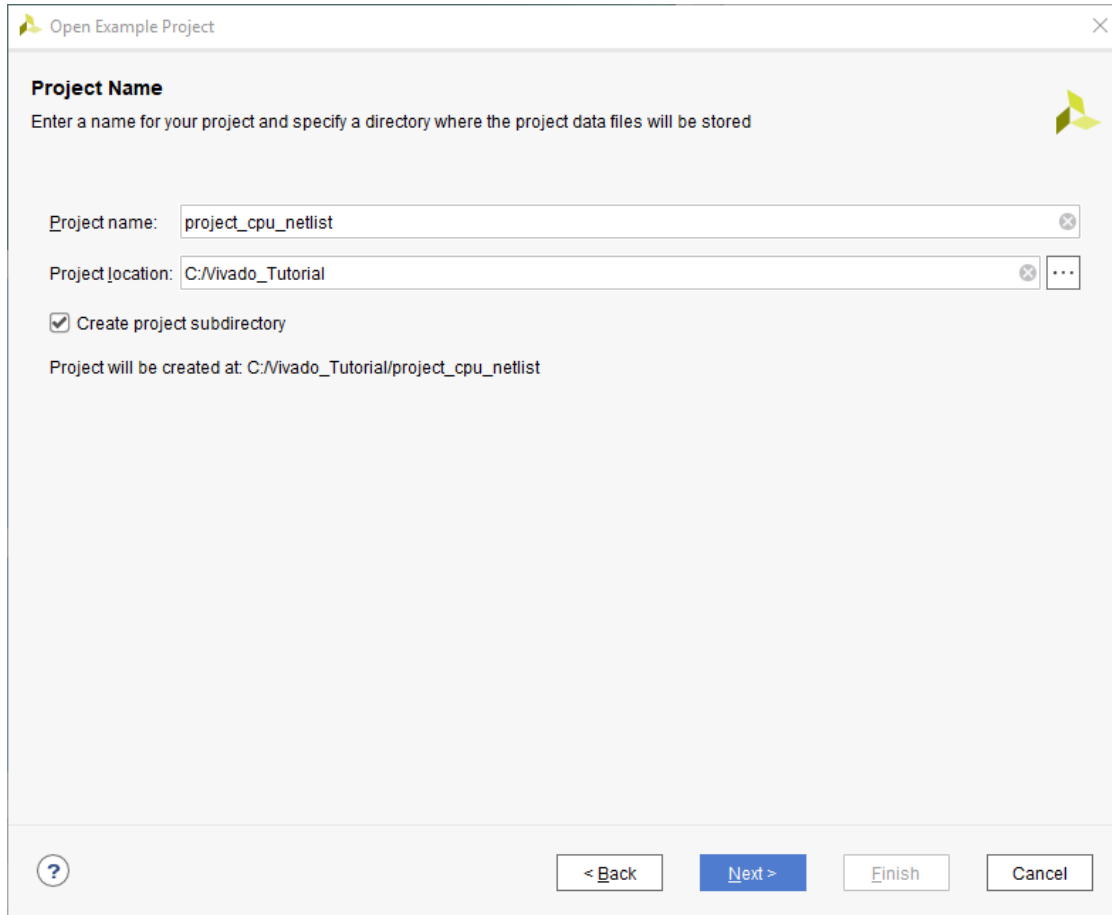

Figure 4: Open Example Project Wizard—Project Name Screen

7. In the Default Part screen, select the **xc7k70tfbg676-2** part and click **Next**.

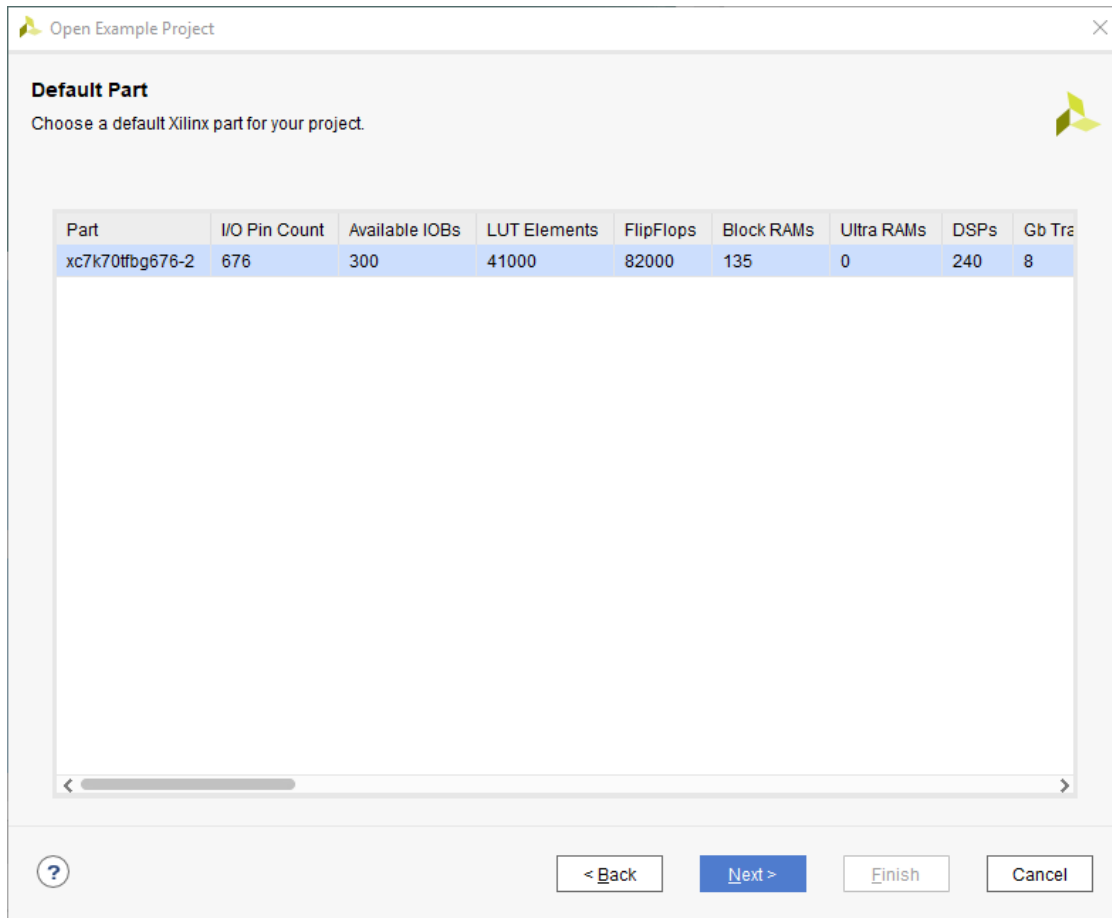

Figure 5: Open Example Project Wizard—Default Part Screen

8. In the New Project Summary screen, review the project details, and click **Finish**.

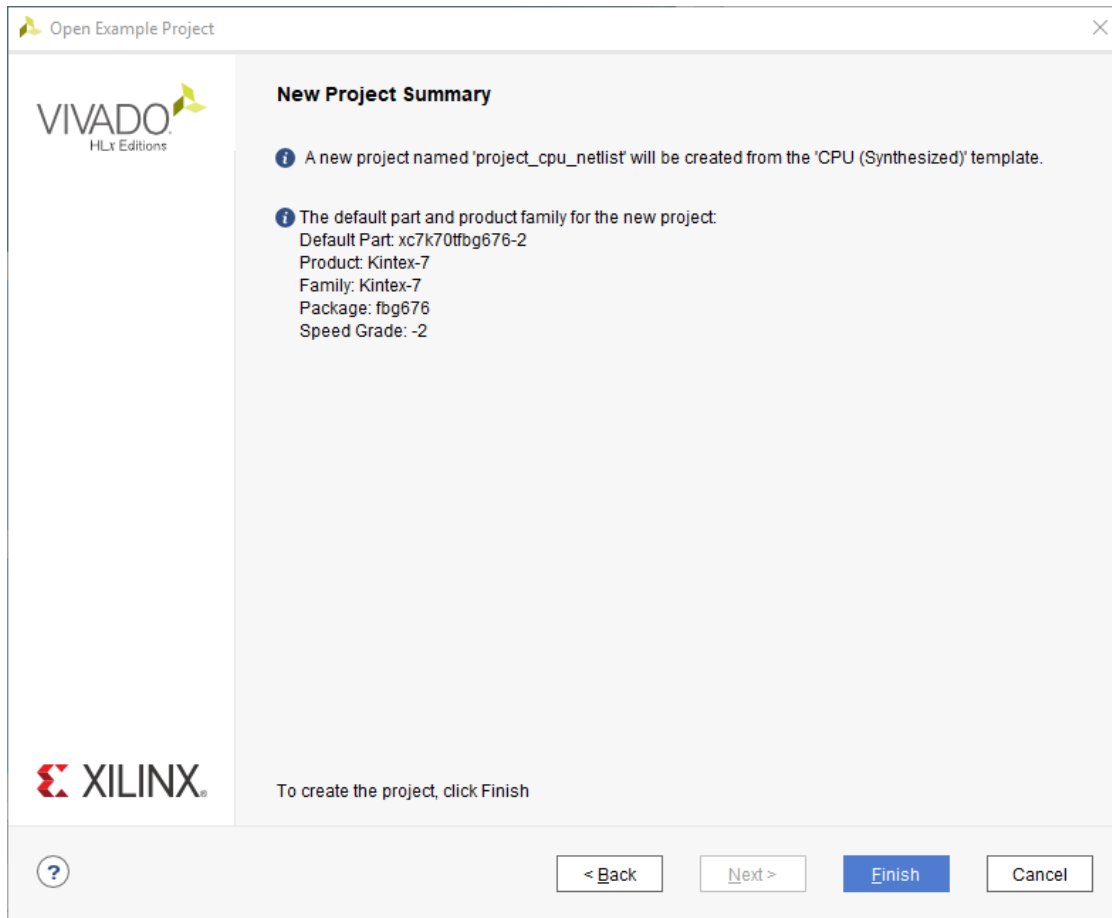

Figure 6: Open Example Project Wizard—New Project Summary Screen

The Vivado IDE opens with the default view.

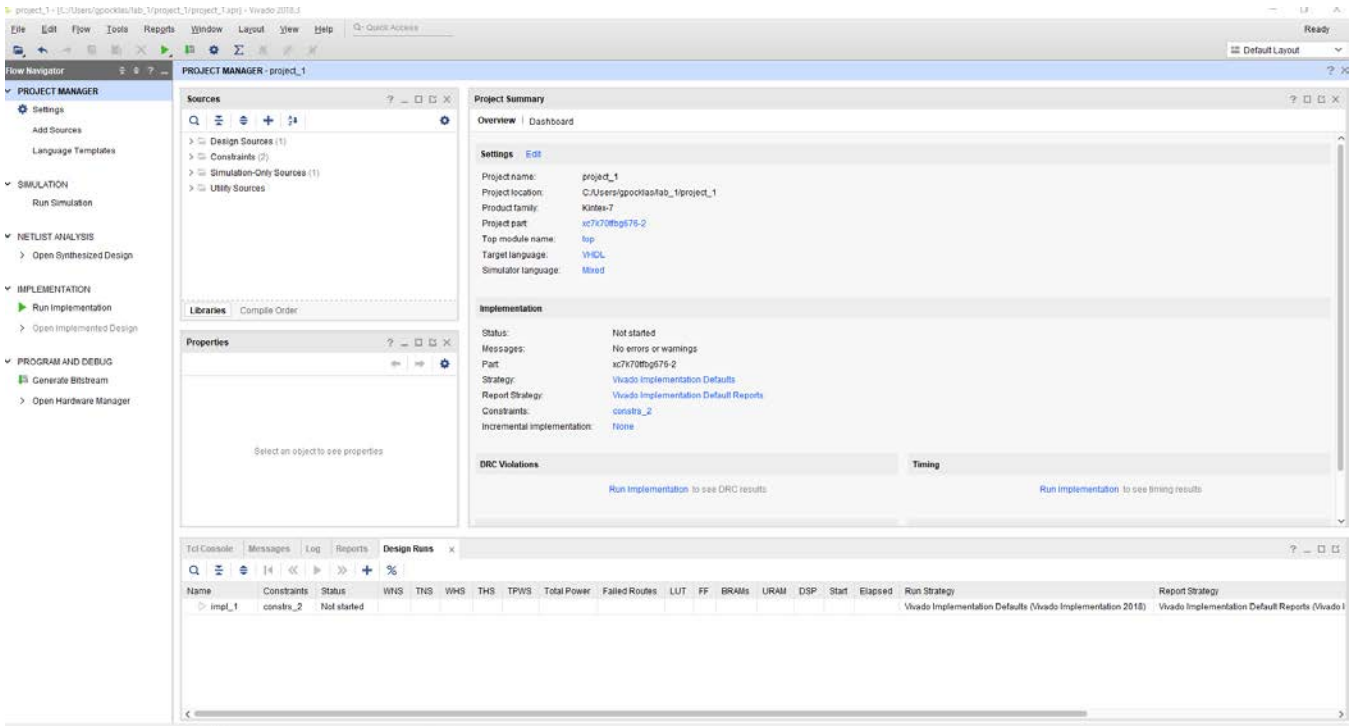

Figure 7: Vivado IDE Showing project_cpu_netlist Project Details

Step 2: Creating Additional Implementation Runs

The project contains previously defined implementation runs as seen in the Design Runs window of the Vivado IDE. You will create new implementation runs and change the implementation strategies used by these new runs.

1. From the main menu, select **Flow > Create Runs**.
2. The Create New Runs wizard opens.
3. Click **Next** to open the Configure Implementation Runs screen.
The screen appears with a new implementation run defined. You can configure this run and add other runs as well.
4. In the **Strategy** drop-down menu, select **Performance_Explore** as the strategy for the run.
5. Click the **Add** button twice to create two additional runs. **+**
6. Select **Flow_RunPhysOpt** as the Strategy for the **impl_3** run.
7. Select **Flow_RuntimeOptimized** as the Strategy for the **impl_4** run.

The Configure Implementation Runs screen now displays three new implementations along with the strategy you selected for each, as shown in the below figure.

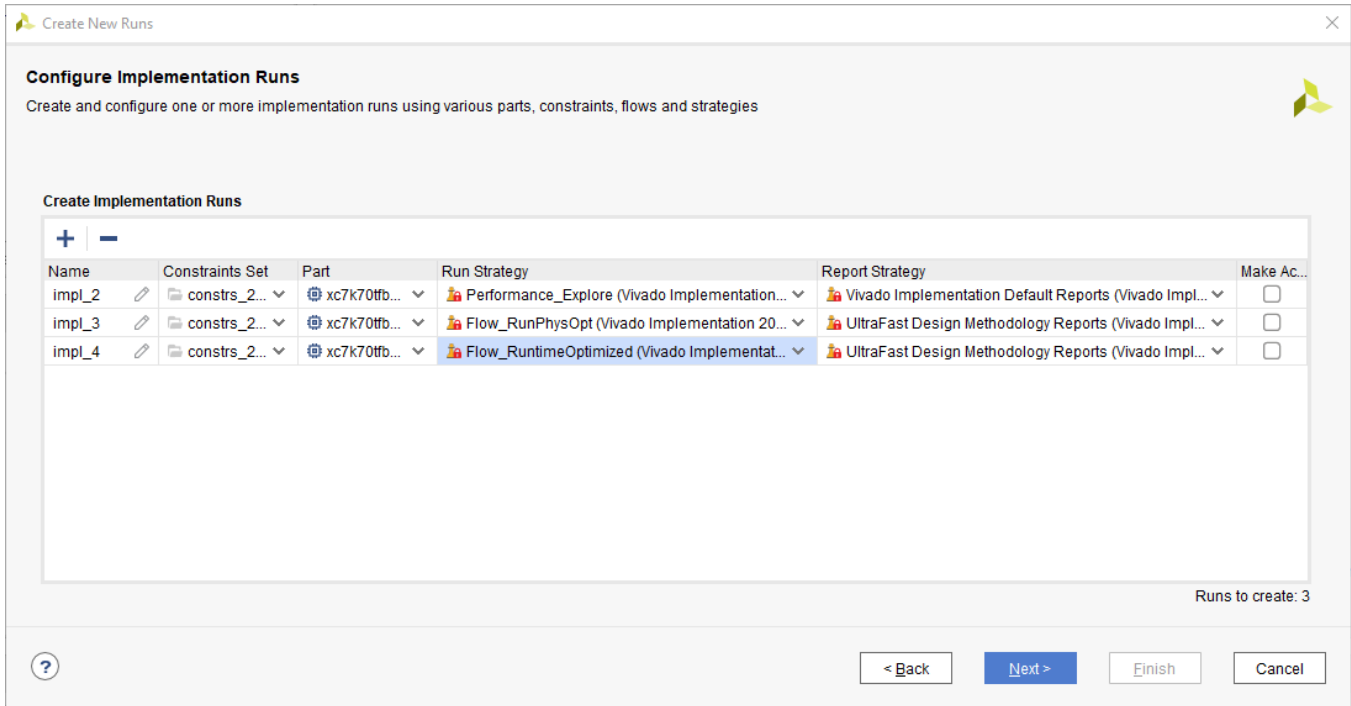

Figure 8: Configure Implementation Runs

- Click **Next** to open the Launch Options screen.
- Select **Do not launch now**, and click **Next** to view the Create New Runs Summary.
- In the Create New Runs Summary page, click **Finish**.

Step 3: Analyzing Implementation Results

- In the Design Runs window, select all the implementation runs.

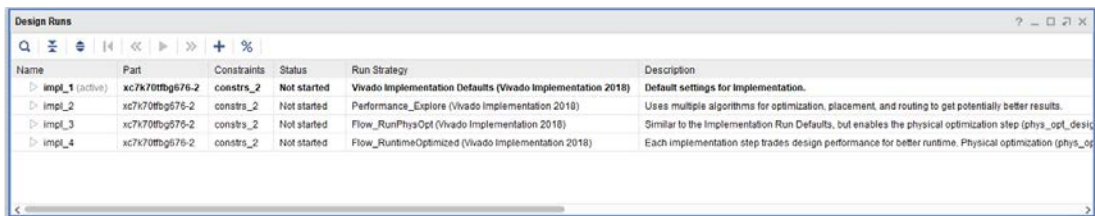

Figure 9: Design Runs Window

- On the sidebar menu, click the **Launch Runs** button
- In the Launch Runs dialog box, select **Launch runs on local host** and **Number of jobs: 4**, as shown below.

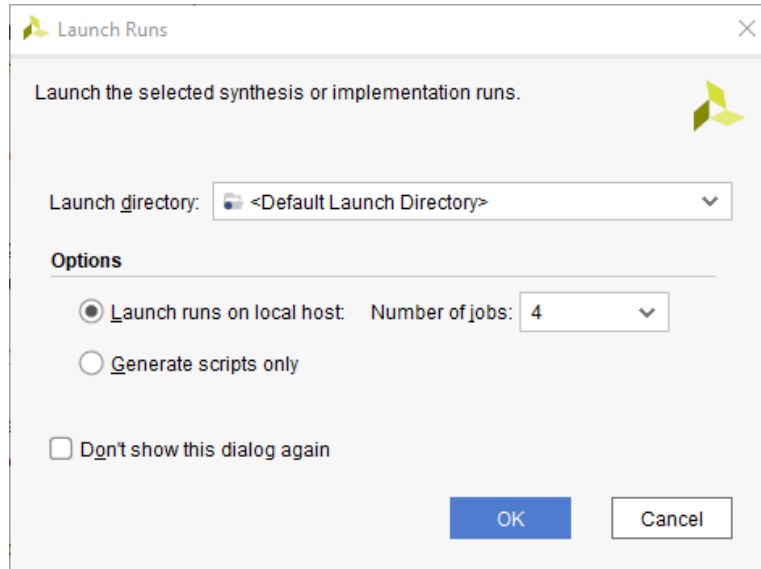

Figure 10: Launch Runs

- Click **OK**.

Two runs launch simultaneously, with the remaining runs going into a queue.

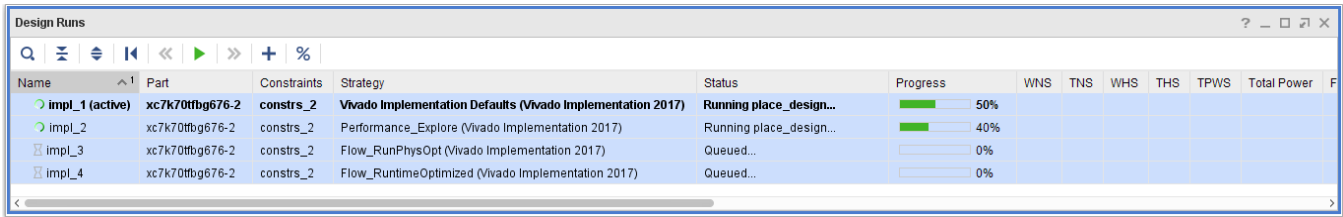

Figure 11: Two Implementation Runs in Progress

When the active run, `impl_1`, completes, examine the Project Summary. The Project Summary reflects the status and the results of the active run. When the active run (`impl_1`) is complete, the Implementation Completed dialog box opens.

- Click **Cancel** to close the dialog box.

Note: The implementation utilization results display as a bar graph at the bottom of the summary page (you might need to scroll down), as shown in the following figure.

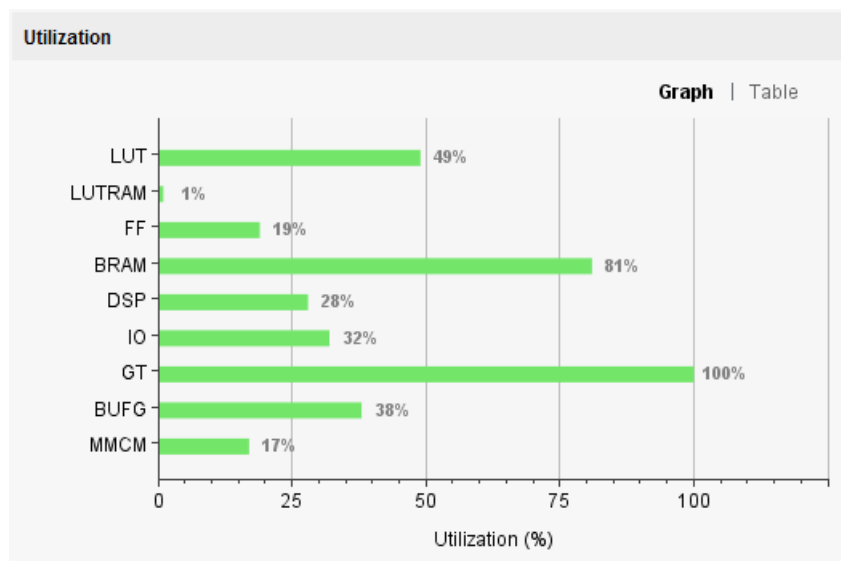

Figure 12: Post-Implementation Utilization

When you open an implementation run, the `report_power` and the `report_timing_summary` results are automatically opened for the run in a new tab in the Results Window.

6. When all the implementation runs are complete, select the **Design Runs** tab.
7. Right-click the **impl_3** run in the Design Runs window, and select **Make Active** from the popup menu.

The Project Summary now displays the status and results of the new active run, **impl_3**.

Name	Part	Constraints	Status	Run Strategy	Elapsed	WNS	Description
impl_1	xc7k70tbg676-2	constrs_2	route_design Complete!	Vivado Implementation Defaults (Vivado Implementation 2018)	00:07:01	0.105	Default settings for Implementation.
impl_2	xc7k70tbg676-2	constrs_2	route_design Complete!	Performance_Explore (Vivado Implementation 2018)	00:07:10	0.105	Uses multiple algorithms for optimization, placement, and routing.
impl_3 (active)	xc7k70tbg676-2	constrs_2	route_design Complete!	Flow_RunPhysOpt (Vivado Implementation 2018)	00:07:36	0.105	Similar to the Implementation Run Defaults, but enables the performance_Explore strategy.
impl_4	xc7k70tbg676-2	constrs_2	route_design Complete!	Flow_RuntimeOptimized (Vivado Implementation 2018)	00:06:54	0.799	Each implementation step trades design performance for better timing closure.

Figure 13: Compare Implementation Results

8. Compare the results for the completed runs in the Design Runs window, as shown in [Figure 13](#).
 - The **Flow_RuntimeOptimized** strategy in **impl_4** completed in the least amount of time, as you can see in the **Elapsed** time column.
 - The WNS column shows that all runs met the timing requirements.

Step 4: Tightening Timing Requirements

To examine the impact of the Performance_Explore strategy on meeting timing, you will change the timing constraints to make timing closure more challenging.

1. In the Sources window, double-click the `top_full.xdc` file in the `constrs_2` constraint set.

The constraints file opens in the Vivado IDE text editor.

```

1  # Define the top level system clock of the design
2  create_clock -period 10 -name sysClk [get_ports sysClk]
3
4  # Define the clocks for the GTX blocks
5  create_clock -name gt0_txusrclk_i -period 12.8 [get_pins mgtEngine/ROCKETIO_WRAPPER_T:
6  create_clock -name gt2_txusrclk_i -period 12.8 [get_pins mgtEngine/ROCKETIO_WRAPPER_T:
7  create_clock -name gt4_txusrclk_i -period 12.8 [get_pins mgtEngine/ROCKETIO_WRAPPER_T:
8  create_clock -name gt6_txusrclk_i -period 12.8 [get_pins mgtEngine/ROCKETIO_WRAPPER_T:
9
10

```

Figure 14: top_full.xdc File

- On line 2, change the period of the `create_clock` constraint from 10 ns to 7.35 ns.

The new constraint should read as follows:

```
create_clock -period 7.35 -name sysClk [get_ports sysClk]
```

- Save the changes by clicking the **Save File** button in the sidebar menu of the text editor.

Note: Saving the constraints file changes the status of all runs using that constraints file from "Complete" to "Out-of-date," as seen in the Design Runs window.

Name	Part	Constraints	Status	Run Strategy	Elapsed	WNS	Description
impl_1	xc7k70fbg676-2	constrs_2	Implementation Out-of-date	Vivado Implementation Defaults (Vivado Implementation 2018)	00:07:01	0.105	Default settings for implementation.
impl_2	xc7k70fbg676-2	constrs_2	Implementation Out-of-date	Performance_Explore (Vivado Implementation 2018)	00:07:10	0.105	Uses multiple algorithms for optimization, placement, and routing.
impl_3 (active)	xc7k70fbg676-2	constrs_2	Implementation Out-of-date	Flow_RunPhysOpt (Vivado Implementation 2018)	00:07:36	0.105	Similar to the Implementation Run Defaults, but enables the physical optimization.
impl_4	xc7k70fbg676-2	constrs_2	Implementation Out-of-date	Flow_RuntimeOptimized (Vivado Implementation 2018)	00:06:54	0.799	Each implementation step trades design performance for better timing.

Figure 15: Implementation Runs Out-of-Date

- In the Design Runs window, select all runs and click the **Reset Runs** button.

- In the Reset Runs dialog box, click **Reset**.

This directs the Vivado Design Suite to remove all files associated with the selected runs from the project directory. The status of all runs changes from "Out-of-date" to "Not started."

- With all runs selected in the Design Runs window, click the **Launch Runs** button.

The Launch Selected Runs window opens.

TIP: You can also launch runs without resetting them first. If the runs are out of date, the Reset Runs dialog box displays. In this dialog box, you can reset the runs before they are launched.

- Select Launch runs on local host and Number of jobs: 2 and click **OK**.

When the active run (`impl_3`) completes, the Implementation Completed dialog box opens.

- Click **Cancel** to close the dialog box.

9. Compare the **Elapsed** time for each run in the Design Runs window, as seen in the following figure.

Name	Part	Constraints	Status	Run Strategy	Elapsed	WNS	TNS	WHS	THS
✓ impl_1	xc7k70tfg676-2	constrs_2	route_design Complete, Failed Timing!	Vivado Implementation Defaults (Vivado Implementation 2018)	00:10:47	-0.400	-3.509	0.046	0.000
✓ impl_2 (active)	xc7k70tfg676-2	constrs_2	route_design Complete, Failed Timing!	Performance_Explore (Vivado Implementation 2018)	00:15:26	-0.079	-0.084	0.046	0.000
✓ impl_3	xc7k70tfg676-2	constrs_2	route_design Complete, Failed Timing!	Flow_RunPhysOpt (Vivado Implementation 2018)	00:13:22	-0.462	-5.340	0.046	0.000
✓ impl_4	xc7k70tfg676-2	constrs_2	route_design Complete, Failed Timing!	Flow_RuntimeOptimized (Vivado Implementation 2018)	00:07:32	-0.526	-5.860	0.055	0.000

Figure 16: Implementation Results After Constraint Change

- Notice that the impl_2 run, using the Performance_Explore strategy is closest to meet timing, but also took the most time to complete.



RECOMMENDED: Reserve the Performance_Explore strategy for designs that have challenging timing constraints. When timing is easily met, the Performance_Explore strategy increases implementation times while providing no timing benefit.

Conclusion

In this lab, you learned how to define multiple implementation runs to employ different strategies to resolve timing. You have seen how some strategies trade performance for results, and learned how to use those strategies in a more challenging design.

This concludes Lab #1. If you plan to continue directly to Lab #2, keep the Vivado IDE open and close the current project. If you do not plan to continue, you can exit the Vivado Design Suite.

Introduction

Incremental Implementation is a flow that should be used when a user wants to get greater consistency of results and/or faster runtimes from Vivado. It should be used when a design is relatively stable and only small changes are required.

After resynthesizing a design with minor changes, the incremental compile flow can speed up placement and routing by reusing results from a prior design iteration. This can help you preserve timing closure while allowing you to quickly implement incremental changes to the design.

In this lab, you use the BFT example design that is included in the Vivado® Design Suite, to learn how to use the incremental compile flow. Refer to the *Vivado Design Suite User Guide: Implementation* ([UG904](#)) to learn more about Incremental Compile.

Step 1: Opening the Example Project

1. Start by loading Vivado IDE by doing one of the following:
 - Launch the Vivado IDE from the icon on the Windows desktop.
 - Type `vivado` from a command terminal.
2. From the Getting Started page, click **Open Example Project**.

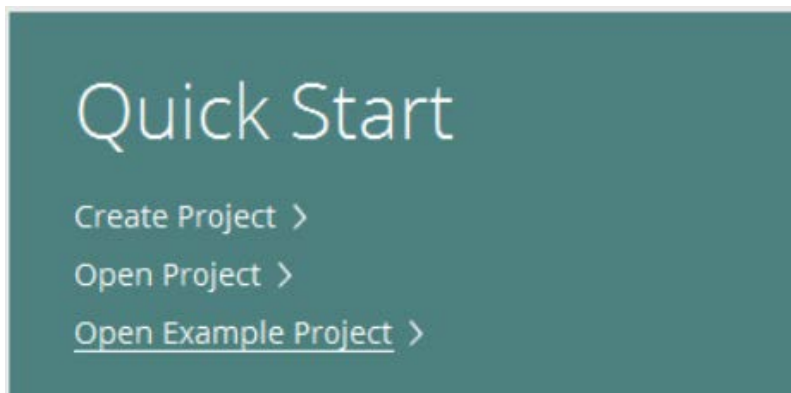

Figure 17: Open Example Project

3. In the Create an Example Project screen, click **Next**.

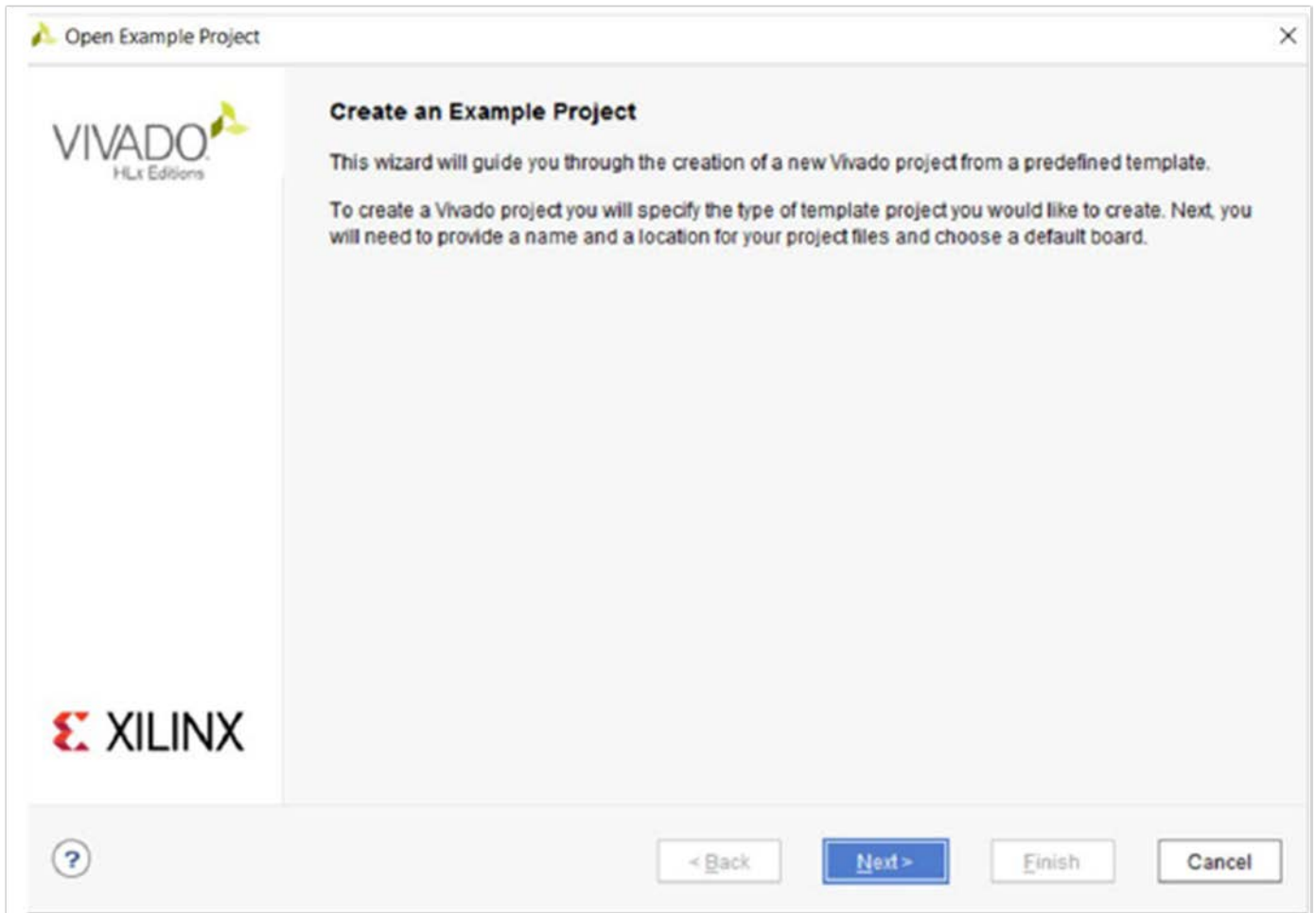

Figure 18: Open Example Project Wizard—Create an Example Project Screen

- In the Select Project Template screen, select the **BFT** (Small RTL project) design, and click **Next**.

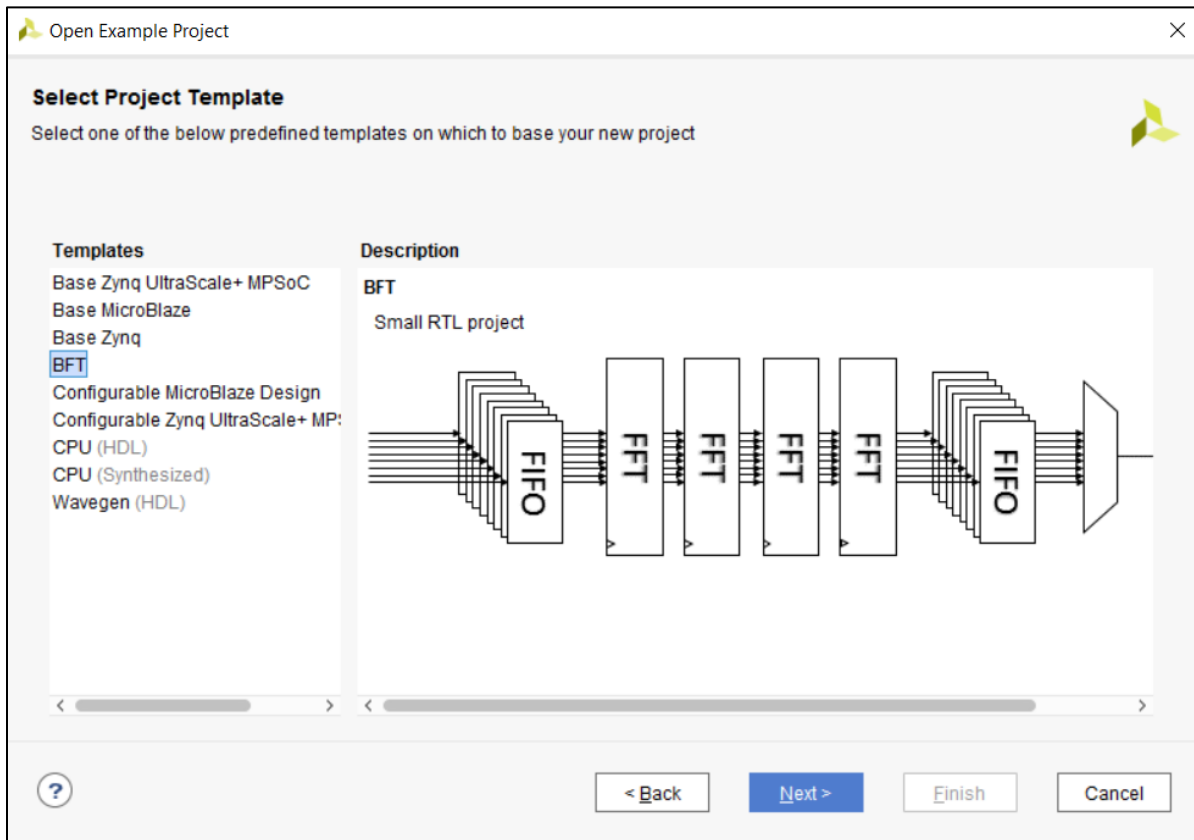

Figure 19: Open Example Project Wizard—Select Project Template Screen

5. In the Project Name screen, specify the following, and click **Next**:

- Project name: **project_bft_core_hdl**
- Project location: <Project_Dir>

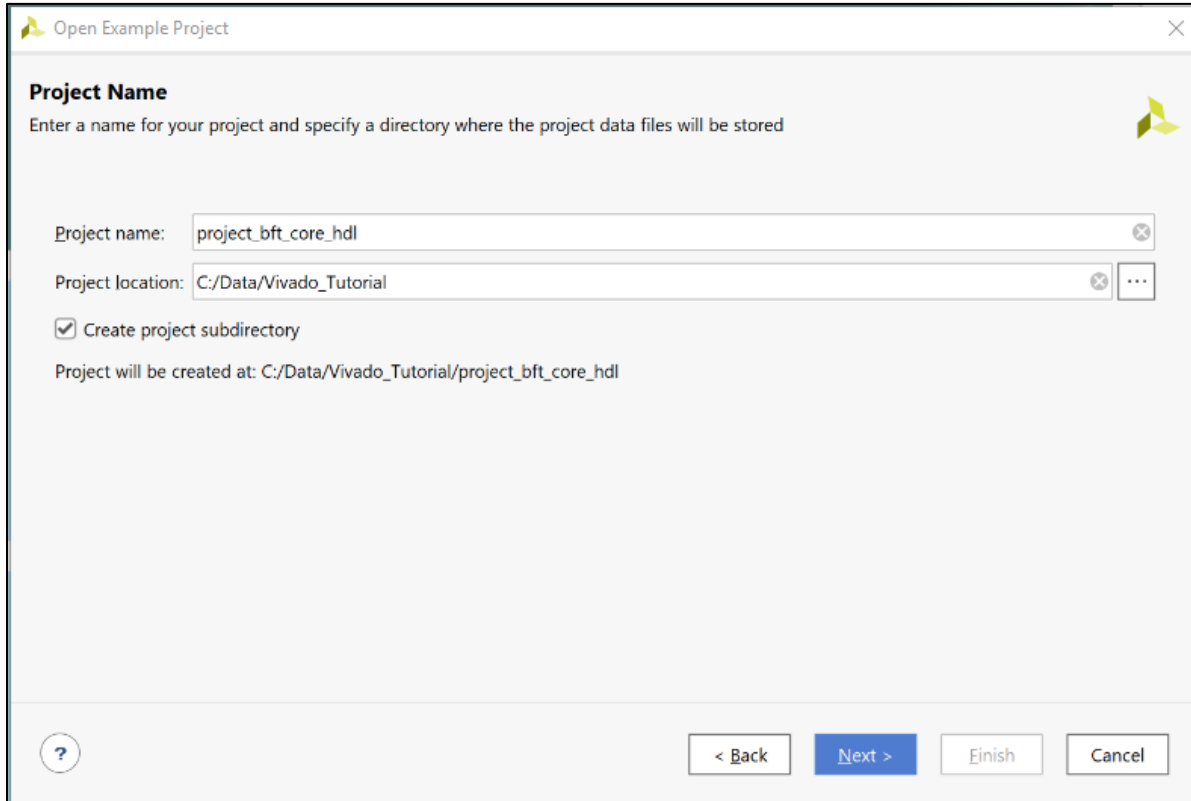

Figure 20: Open Example Project Wizard—Project Name Screen

6. In the Default Part screen, select the **xc7k70tfbg484-2** part, and click **Next**.

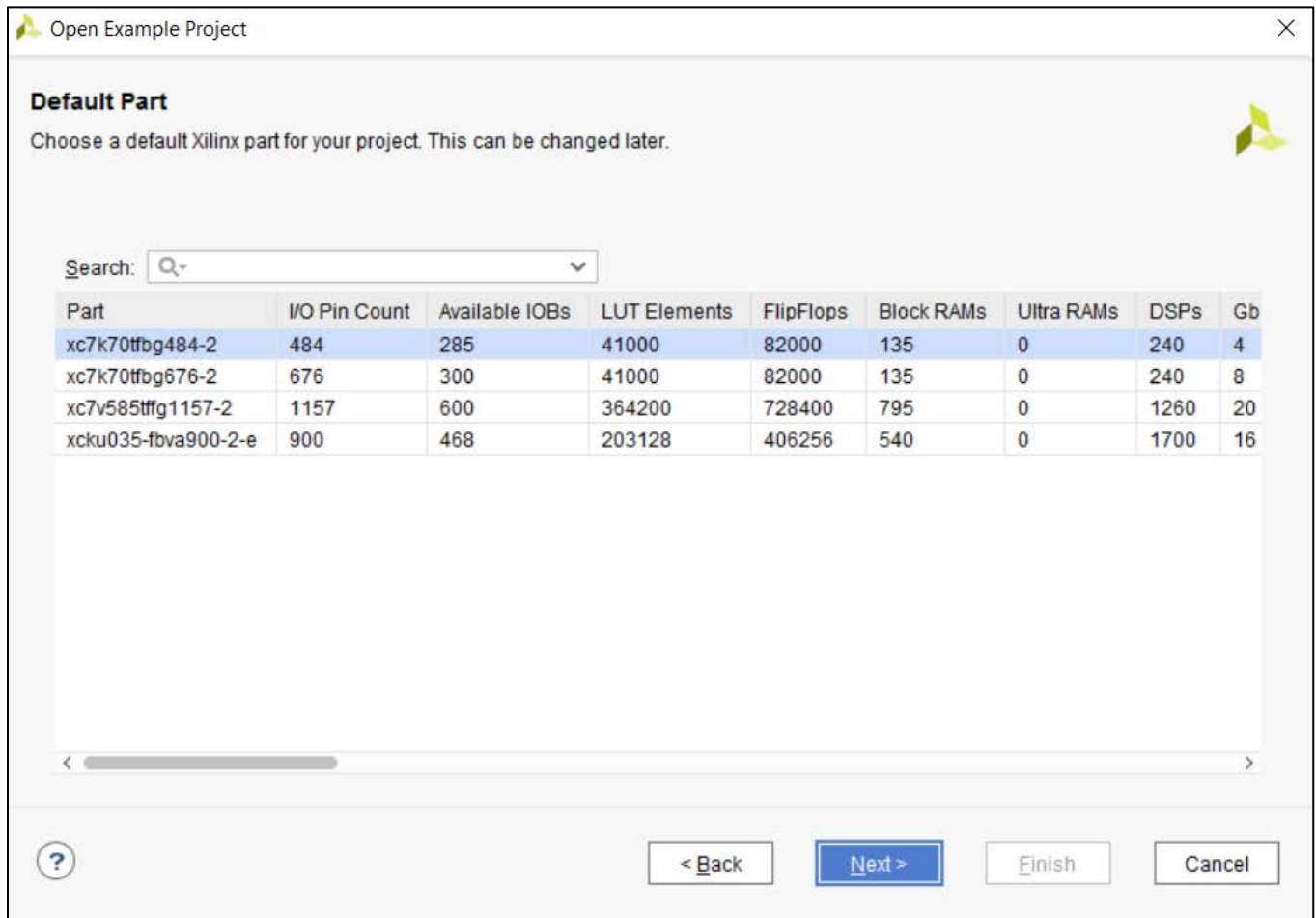

Figure 21: Open Example Project Wizard—Default Part Screen

7. In the New Project Summary screen, review the project details, and click **Finish**.

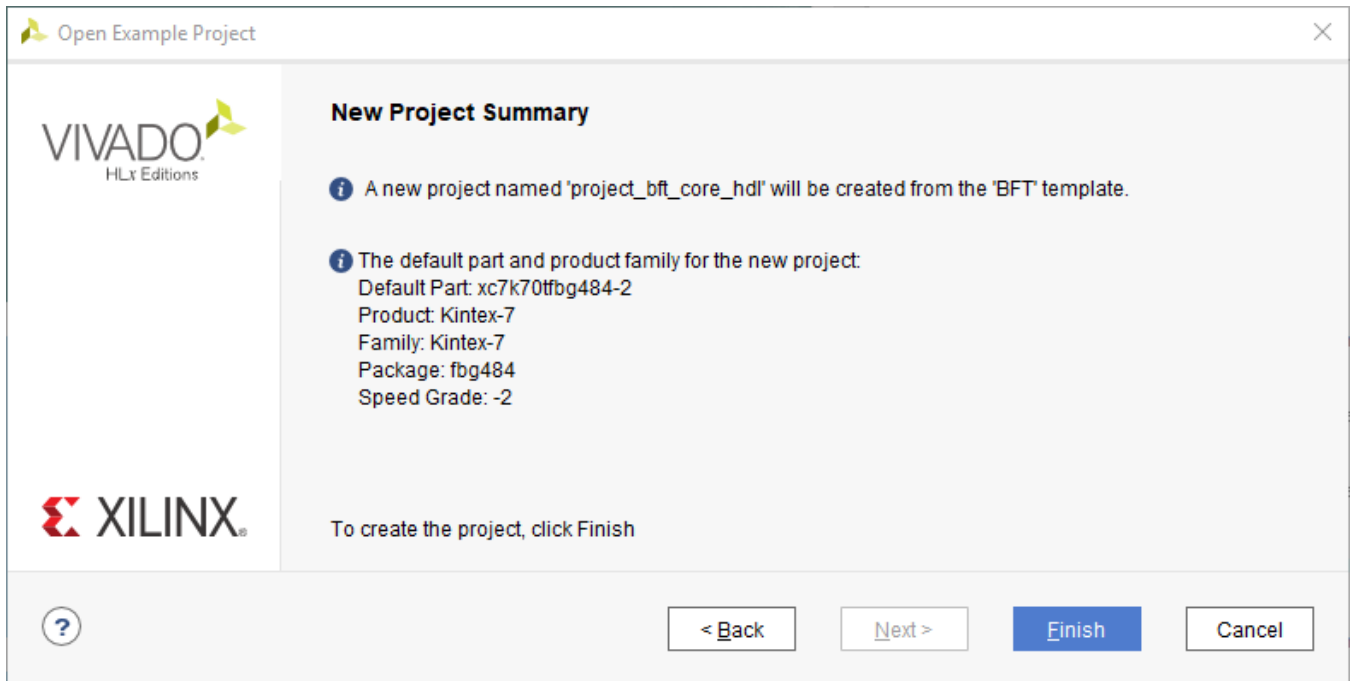

Figure 22: Open Example Project Wizard—New Project Summary Screen

The Vivado IDE opens with the default view.

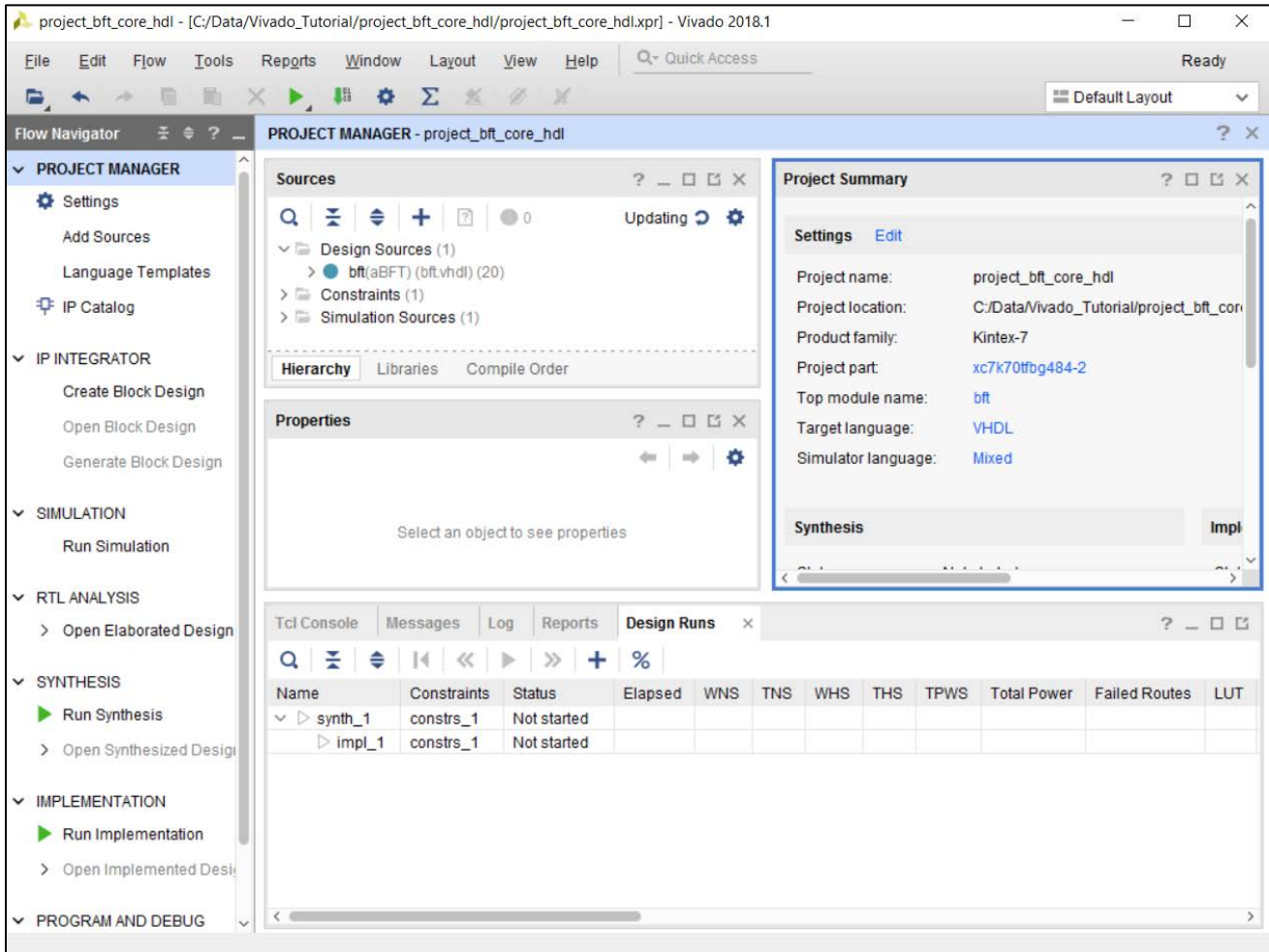

Figure 23: Vivado IDE Showing project_bft_core_hdl Project Details

Step 2: Viewing the Incremental Heading in the Design Runs Window

In the design runs window, right-click on any of the column headings and enable the Incremental column if it is not already enabled, as shown in the following figures:

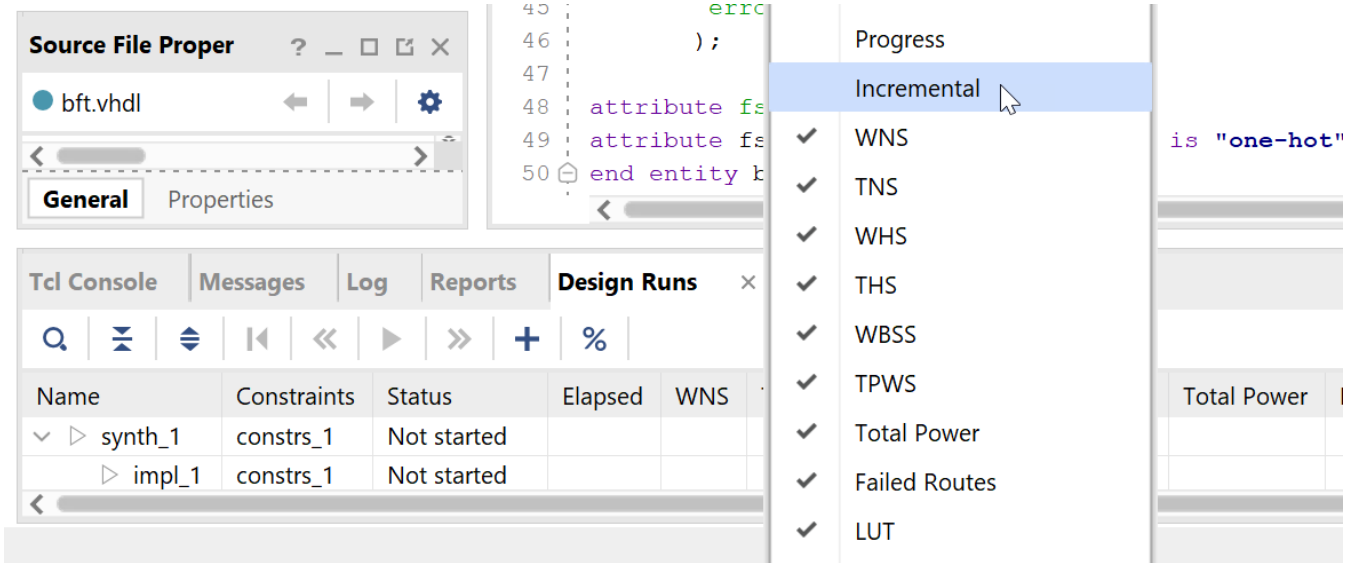

Figure 24 : Enabling Incremental Heading

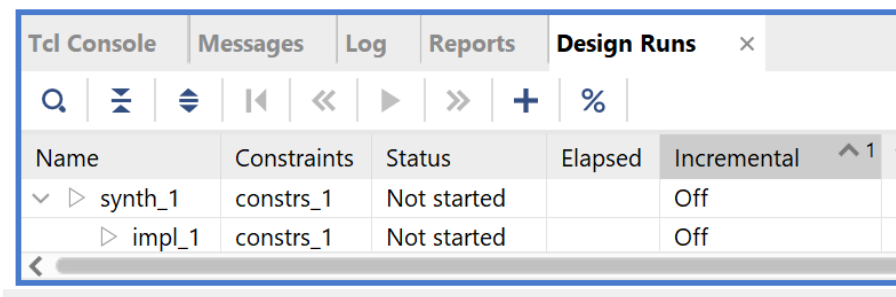

Figure 25: Design Runs Window

This column shows how the incremental flow was used. The information is also be available in the messages that are output in the Vivado log file.

Step 3: Turning on Incremental Implementation

1. Right-click on the **impl_1** run and select **Set Incremental Implementation**.

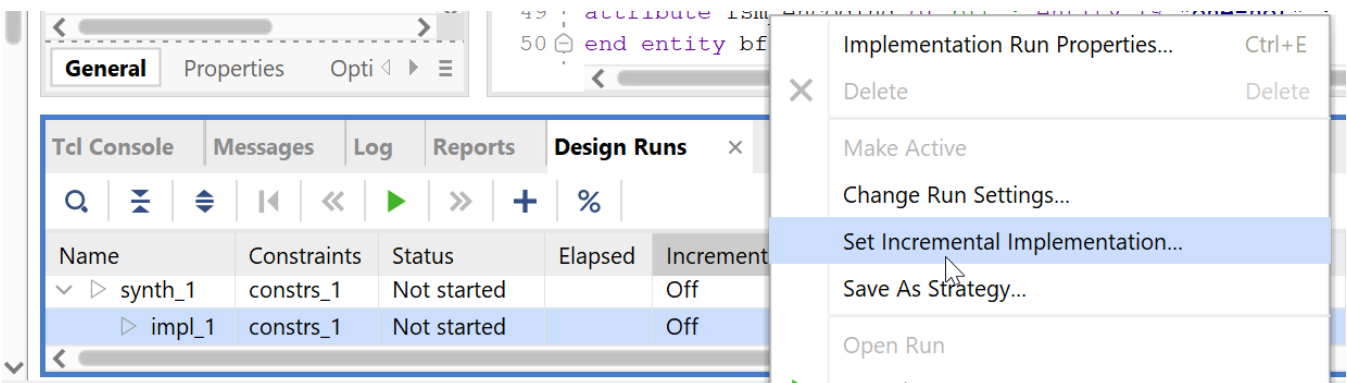

Figure 26: Enabling Incremental Implementation in the Design Runs Window

2. In the dialog box, select **Automatically use the checkpoint from the previous run.**

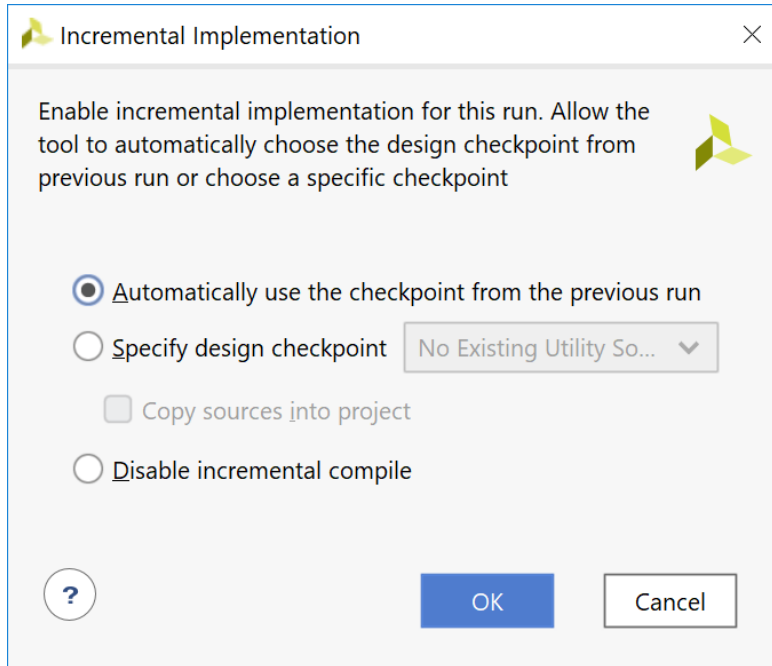

Figure 27: Selecting the Incremental Mode, Automatic or User Selected Checkpoint

This dialog box can be opened from many places inside the Vivado IDE. These include the Implementation Run Options window and the Project Summary. The same functionality can also be built into scripts via TCL commands.

3. To enable automatic checkpoint selection via TCL, use the following command:

```
set_property AUTO_INCREMENTAL_CHECKPOINT 1 [get_runs impl_1]
```

After this is done, you should see the Incremental Column in the design runs window update to Auto(skipped). This setting indicates that Auto mode is enabled but that Incremental Implementation has not been run.

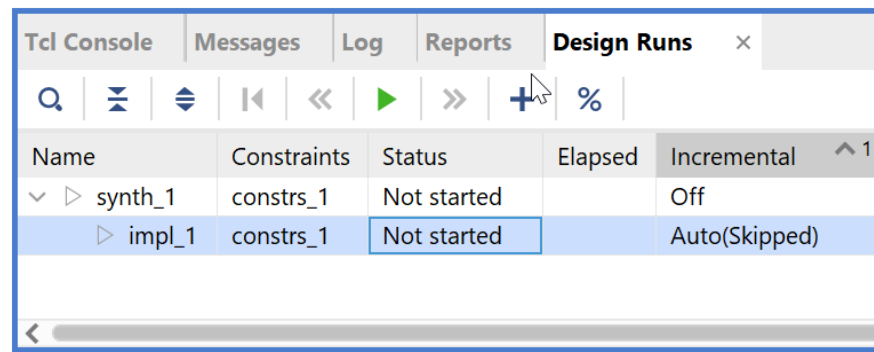

Figure 28: Design Runs Window (Auto Incremental Implementation Enabled)

It is possible to select your own checkpoint, which is desirable when the checkpoint must not be updated or lower thresholds for reuse are OK to use. It is your responsibility to manage the suitability of the checkpoint in this case.

Step 4: Compiling the Reference Design

1. From the Flow Navigator, select **Run Implementation**.
2. In the Missing Synthesis Results dialog box that appears, click **OK** to launch synthesis first. Synthesis runs, and implementation starts automatically when synthesis completes.

Note: The dialog box appears because you are running implementation without first running synthesis.

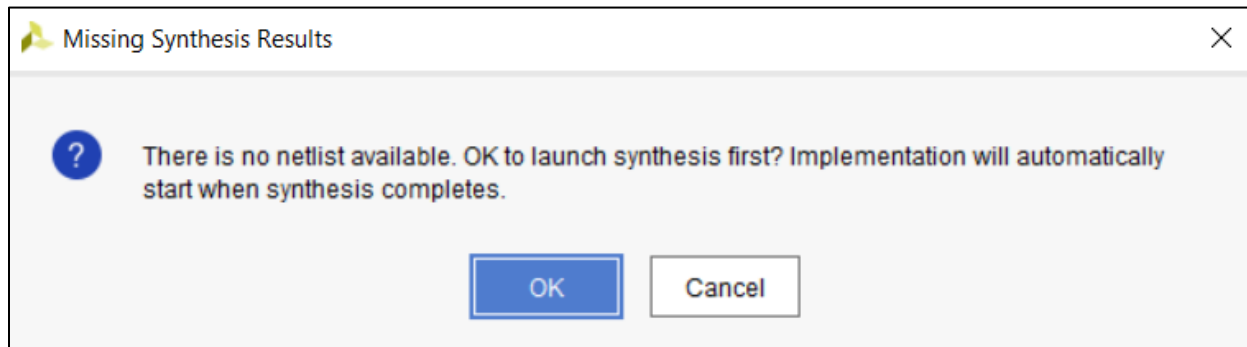

Figure 29: Missing Synthesis Results

3. After implementation finishes, the Implementation Complete dialog box opens. Click **Cancel** to dismiss the dialog box.

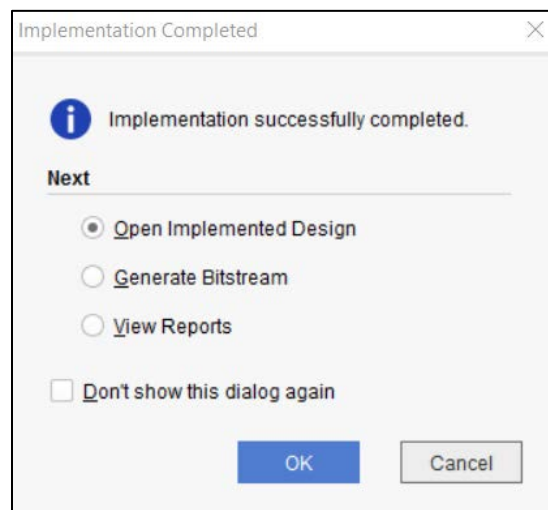

Figure 30: Implementation Completed

In a project-based design, the Vivado Design Suite saves intermediate implementation results as design checkpoints in the implementation runs directory. You will use the final checkpoint as the reference to the incremental compile flow.

Step 5: Making Incremental Changes

In this step, you make minor changes to the RTL design sources. These changes necessitate resynthesizing the netlist and re-implementing the design.

1. In the Hierarchy tab of the Sources window, double-click the top-level VHDL file, `bft.vhdl`, to open the file in the Vivado IDE text editor, as shown in the following figure.

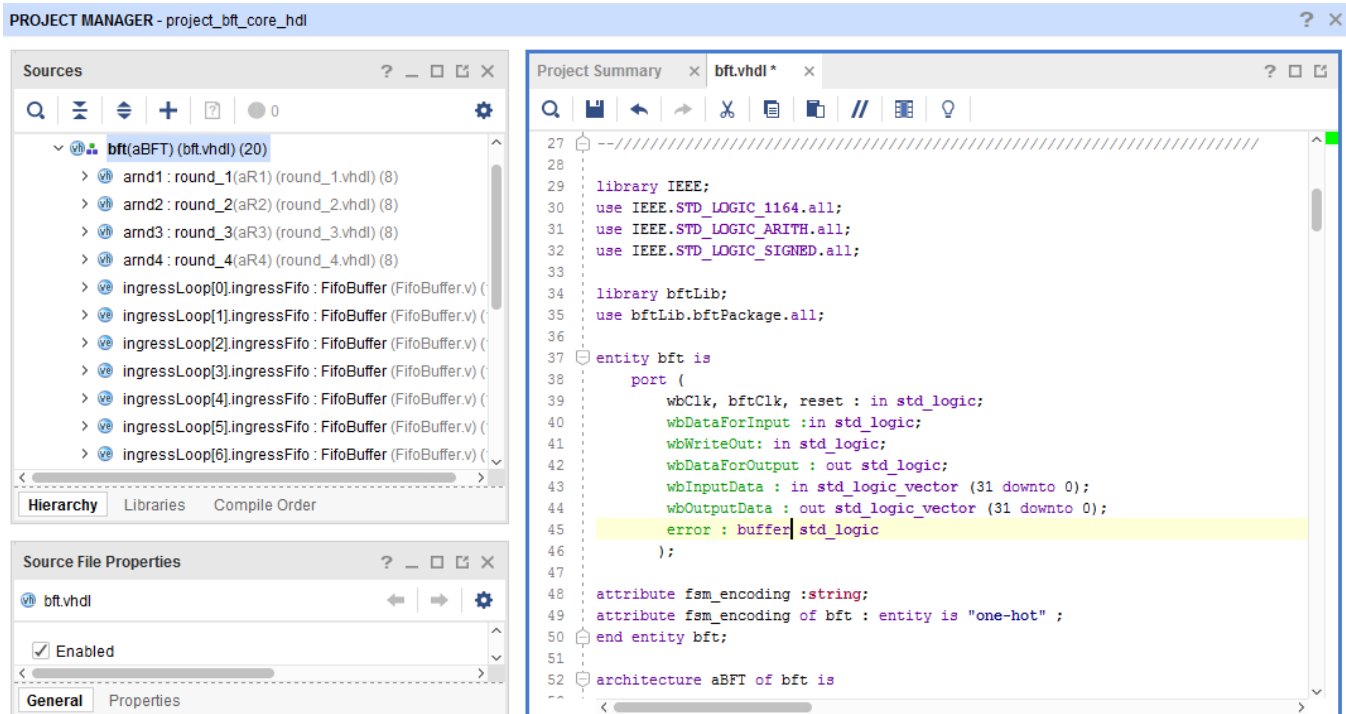

Figure 31: BFT VHDL File

2. Go to **line 45** of the `bft.vhdl` file and change the error port from an output to a buffer, as follows:
`error : buffer std_logic`

3. Go to **line 331** of the `bft.vhdl` file and modify the VHDL code, as follows:

From	To
<pre>-- enable the read fifo process (fifoSelect) begin readEgressFifo <= fifoSelect; end process;</pre>	<pre>-- enable the read fifo process (fifoSelect, error) begin if (error = '0') then readEgressFifo <= fifoSelect; else readEgressFifo <= (others => '0'); end if; end process;</pre>

The results should look like the following figure.

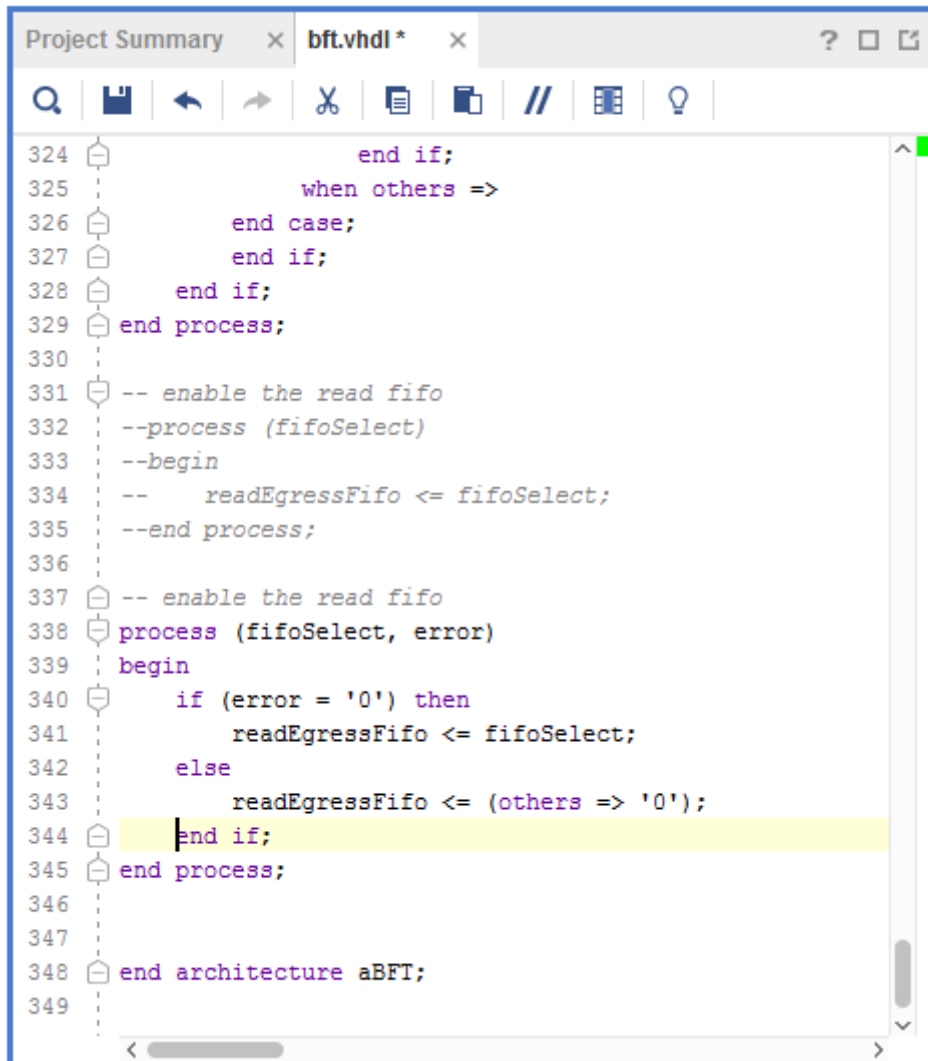

```

324     end if;
325     when others =>
326     end case;
327     end if;
328     end if;
329 end process;
330
331 -- enable the read fifo
332 --process (fifoSelect)
333 --begin
334 --    readEgressFifo <= fifoSelect;
335 --end process;
336
337 -- enable the read fifo
338 process (fifoSelect, error)
339 begin
340     if (error = '0') then
341         readEgressFifo <= fifoSelect;
342     else
343         readEgressFifo <= (others => '0');
344     end if;
345 end process;
346
347
348 end architecture aBFT;
349
    
```

Figure 32: Modified VHDL Code

4. Save the changes by clicking the **Save File** button in the sidebar menu of the text editor.

As you can see in the following figure, changing the design source files also changes the run status for finished runs from **Complete** to **Out-of-date**.

Name	Constraints	Status	Elapsed	Incremental	WNS	TNS	WHS	THS
synth_1	constrs_1	Synthesis Out-of-date	00:01:23	Off				
impl_1	constrs_1	Implementation Out-of-date	00:02:41	Auto(Skipped)	1.452	0...	0.062	0...

Figure 33: Design Runs Out-of-Date

Step 6: Rerunning the Synthesis and Implementation

With changes to the RTL source now made, synthesis and implementation must be rerun. As Incremental Implementation has already been configured, all that must be done is to relaunch the tool flow as would be done in the default flow.

1. In the flow navigator, click on **Run Implementation**. At this point, all the runs are reset and relaunched.

In the design sources window, the Utility Source is updated with the checkpoint from the previously routed impl_1 if the checkpoint has met certain criteria to ensure it is a good quality reference checkpoint for future runs.

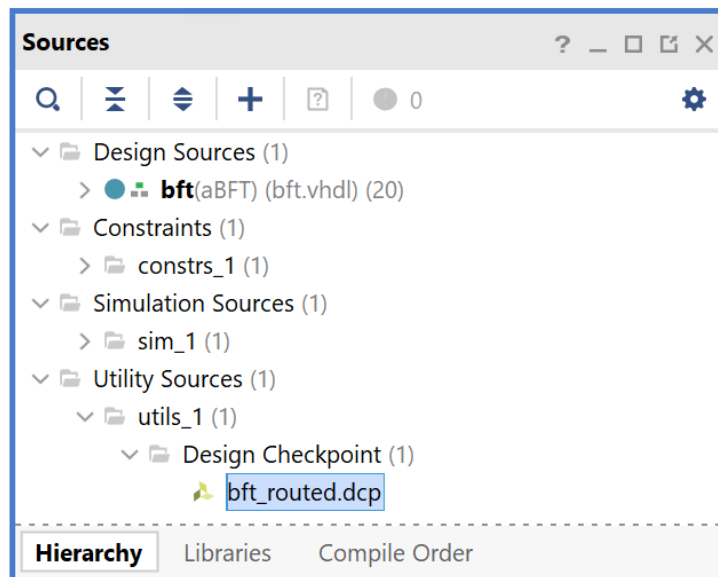

Figure 34: Reference Checkpoint in Utility Sources

Also updated is the **Incremental** column in the **Design Runs** window. This should now say **Auto**. If the checkpoint did not meet the criteria to be used as a suitable reference, it shows **Auto(Skipped)** as before.

After implementation is complete, the design runs window shows the completed run.

Name	Constraints	Status	Elapsed	Incremental	WNS	TNS	WHS	THS	WBSS	TPWS	Total Power
synth_1	constrs_1	synth_design Complete!	00:01:02	Off							
impl_1	constrs_1	route_design Complete!	00:01:31	Auto	1.452	0.000	0.062	0.000		0.000	0.41

Figure 35: Design Runs Window after Completion

In the **Design Runs** window, it is possible to examine runtime and timing criteria. In this case:

- Runtime has improved from 2:13 to 1:31 for implementation as seen in the **Elapsed** column.
- WNS has been maintained at 1.452

Note: *Synthesis has not been run in a different mode than before so should be similar to before.*

The “Elapsed” column measurement includes improvements to the place_design (phys_opt_design is not run here) and route_design and also the extra commands that are required in the incremental flow such as read_checkpoint -incremental and the extra reporting. To see more significant runtime improvements, the flow should be used on larger designs with a good reference checkpoint.

Note: *opt_design is not incremental and runtime for opt_design is unimpacted.*

Designs that have a complex flow, requiring most effort in the reference run see the highest benefit. Ideally, reference checkpoints are timing-closed, with fewer than 5% of the leaf cells different than the updated design.

2. Select the **Reports** tab in the Results Window area and double-click the **Incremental Reuse Report** in the Route Design section, as shown in the following figure.

Report	Report Type
Route Design (route_design)	
impl_1_route_report_drc_0	Report on error or violations against a set of design rule checks (report_drc)
impl_1_route_report_methodology_0	Report on error or violations against a set of methodology checks (report_methodology)
impl_1_route_report_power_0	Report power analysis details (report_power)
impl_1_route_report_route_status_0	Report on status of the routing. (report_route_status)
impl_1_route_report_timing_summary_0	Report timing summary (report_timing_summary)
impl_1_route_report_incremental_reuse_0	Report on achievable incremental reuse for the given design-checkpoint (report_incremental_reuse)
impl_1_route_report_clock_utilization_0	Report information about clock nets in design (report_clock_utilization)
impl_1_route_report_bus_skew_0	Report on calculated bus skew among the signals constrained by set_bus_skew (report_bus_skew)

Figure 36: Reports Window

So far, you have modified the generation of the readEgressFifo so that the signal is zero when the error signal is non-zero. This is a small change to the design so you would expect the reuse to be high. Now examine the Incremental Reuse Report to confirm this is the case.

Incremental Implementation Information

Table of Contents

- 1. Reuse Summary
- 2. Reference Checkpoint Information
- 3. Comparison with Reference Run
- 4. Non Reuse Information

1. Reuse Summary

Type	Matched % (of Total)	Reuse % (of Total)	Fixed % (of Total)	Total
Cells	99.07	99.52	1.98	3578
Nets	99.71	98.97	0.00	5189
Pins	-	89.30	-	19495
Ports	100.00	100.00	100.00	71

* Reused % can exceed matched % when unmatched cells take their placement directly from other cells that have been matched

2. Reference Checkpoint Information

DCP Location: C:/Vivado_Tutorial/project_bft_core/project_bft_core.sracs/utills_1/imports/impl_1/bft_routed.dcp

DCP Information	Value
Vivado Version	2019.1
DCP State	POST_ROUTE
Recorded WNS	1.450
Recorded WHS	0.059
Reference Speed File Version	PRODUCTION 1.12 2017-02-17
Incremental Speed File Version	PRODUCTION 1.12 2017-02-17

* Recorded WNS/WHS timing numbers are estimated timing numbers. They may vary slightly from sign-off timing numbers.

Figure 37: Incremental Reuse Report

In the report you can confirm that a high percentage of cells, nets and ports are fully reused.

In the Reference Checkpoint Information section you can see information reported on the reference checkpoint. This is useful when the source of the checkpoint is unknown.

3. Comparison with Reference Run

Stage	WNS (ns)		Runtime (elapsed) (hh:mm)		Runtime (cpu) (hh:mm)	
	Reference	Incremental	Reference	Incremental	Reference	Incremental
synth_design			< 1 min	00:01	< 1 min	00:01
opt_design			00:01	00:01	00:01	00:01
read_checkpoint				< 1 min		< 1 min
place_design	2.209	1.795	< 1 min	< 1 min	00:01	< 1 min
route_design	1.794	1.793	00:01	00:01	00:01	00:01

4. Non Reuse Information

Type	%
Non-Reused Cells	0.62
New	0.62
Partially reused nets	0.00
Non-Reused nets	0.54
Non-Reused Ports	0.00

Figure 38: Incremental Reuse Report

In the Comparison with Reference Run section, you can see how the runtime and WNS at each stage of the flow compares. This is good for debugging purposes to understand where WNS and runtime diverge when there are issues. Note that these designs are not 100% the same so this information is a only guide.

The WNS in the reference checkpoint section is the target WNS of the incremental run as this is run with the Default directive at place_design and route_design. If you target the Explore directive, the target WNS will be 0.00 ns. You can confirm this by searching the log file for place_design. Directly after place_design, the following is reported.

Conclusion

This concludes Lab #2. You can close the current project and exit the Vivado IDE.

In this lab, you learned how to run the Incremental Implementation portion of the Incremental Compile flow, using a checkpoint from a previously implemented design. You also examined the similarity between a reference design checkpoint and the current design by examining the Incremental Reuse Report.

Introduction

In this lab, you learn how to use the Vivado[®] IDE to assign routing to nets for precisely controlling the timing of a critical portion of the design.

- You will use the BFT HDL example design that is included in the Vivado Design Suite.
- To illustrate the manual routing feature, you will precisely control the skew within the output bus of the design, `wbOutputData`.

Step 1: Opening the Example Project

1. Start by loading Vivado IDE by doing one of the following:
 - Launch the Vivado IDE from the icon on the Windows desktop.
 - Type `vivado` from a command terminal.
2. From the Getting Started page, click **Open Example Project**.

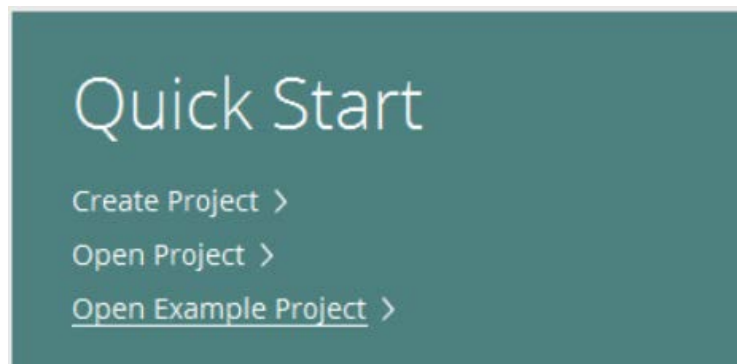

Figure 39: Open Example Project

3. In the Create an Example Project screen, click **Next**.

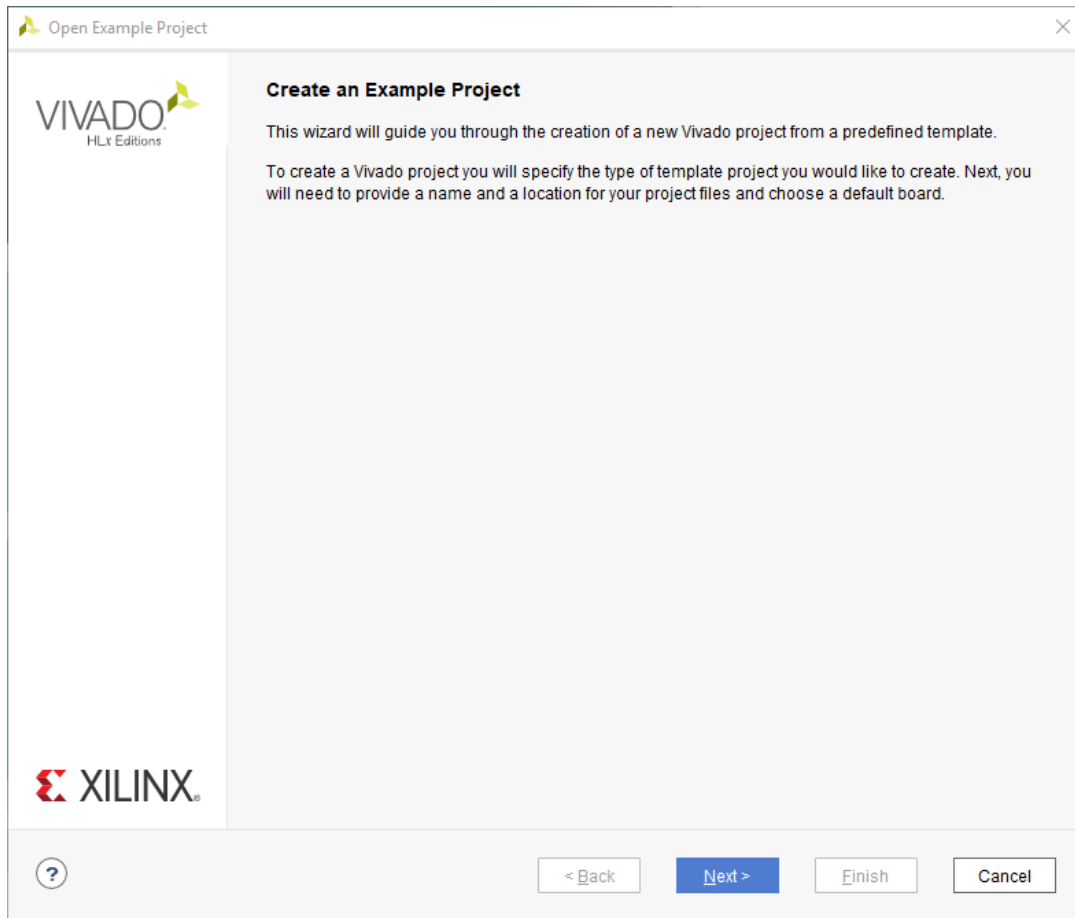

Figure 40: Open Example Project Wizard—Create an Example Project Screen

- In the Select Project Template screen, select the **BFT** (Small RTL project) design, and click **Next**.

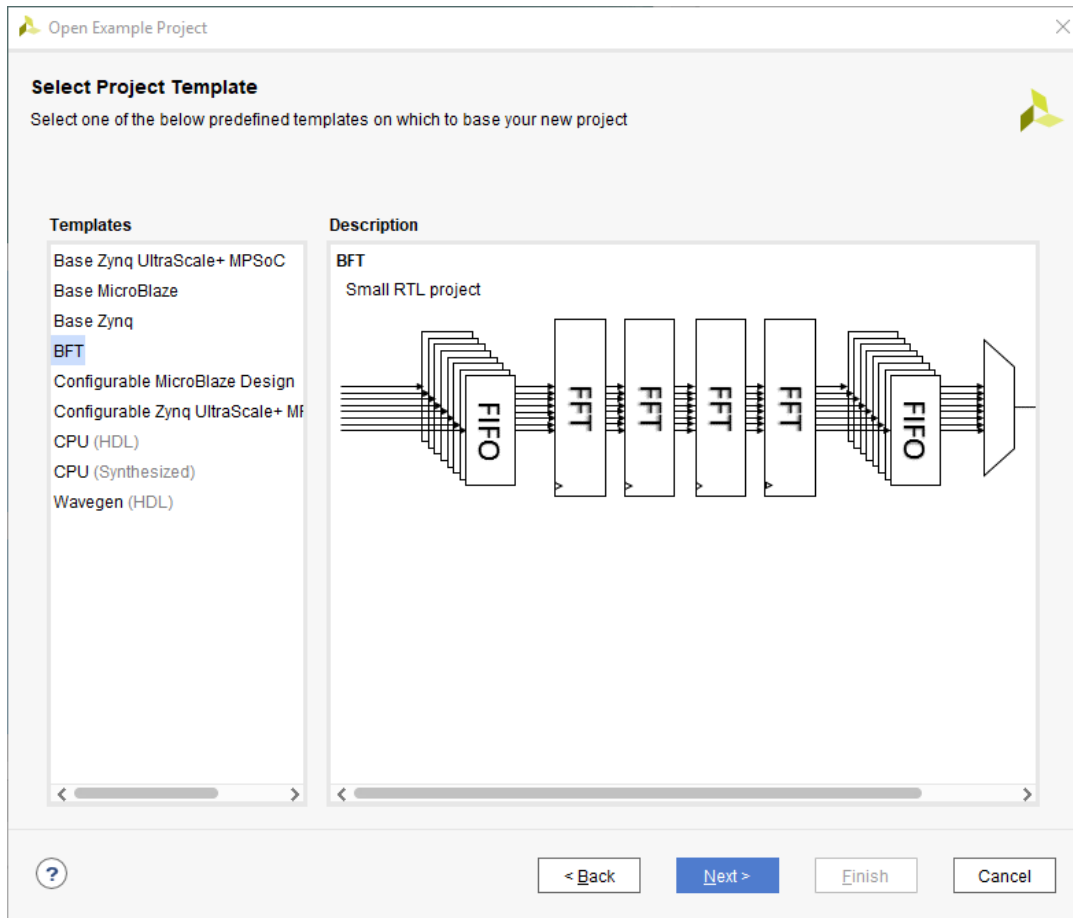

Figure 41: Open Example Project Wizard—Select Project Template Screen

5. In the Project Name screen, specify the following, and click **Next**:

- o Project name: **project_bft_core**
- o Project location: <Project_Dir>

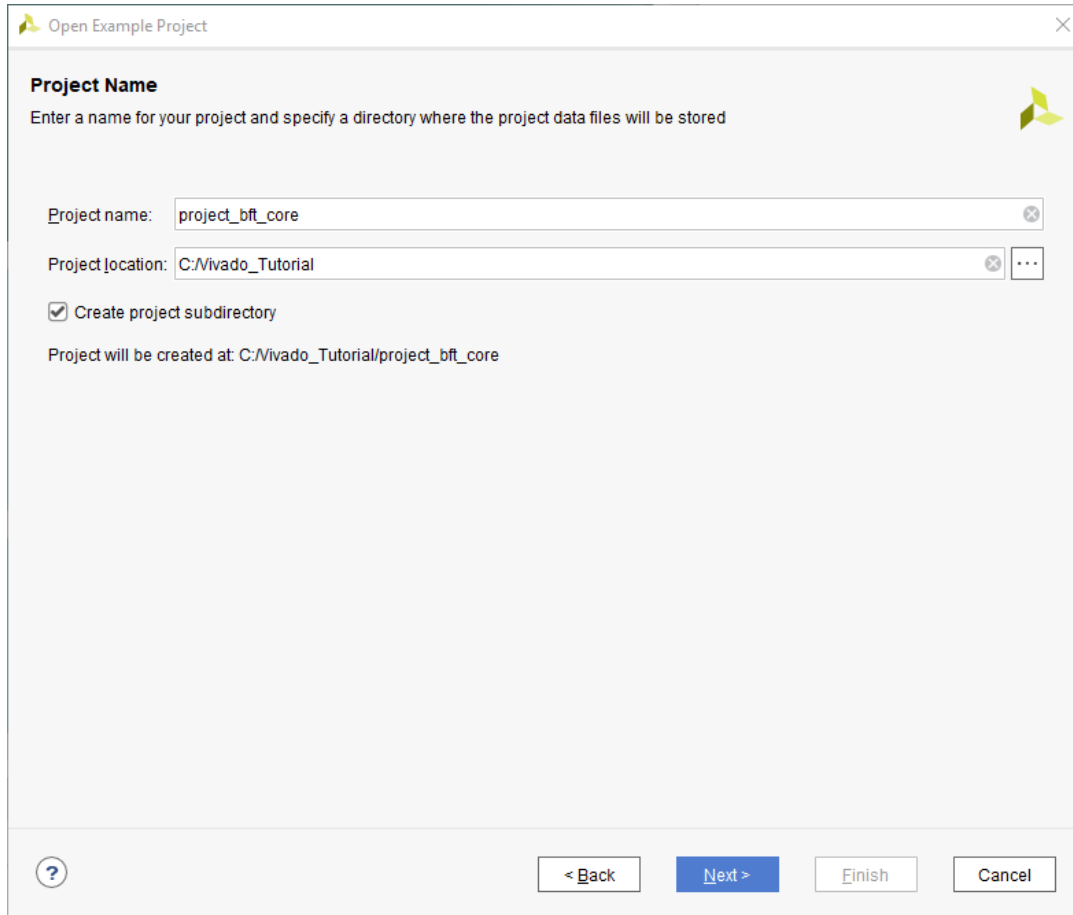

Figure 42: Open Example Project Wizard— Project Name Screen

6. In the Default Part screen, select the **xc7k70tfbg484-2** as your Default Part, and click **Next**.

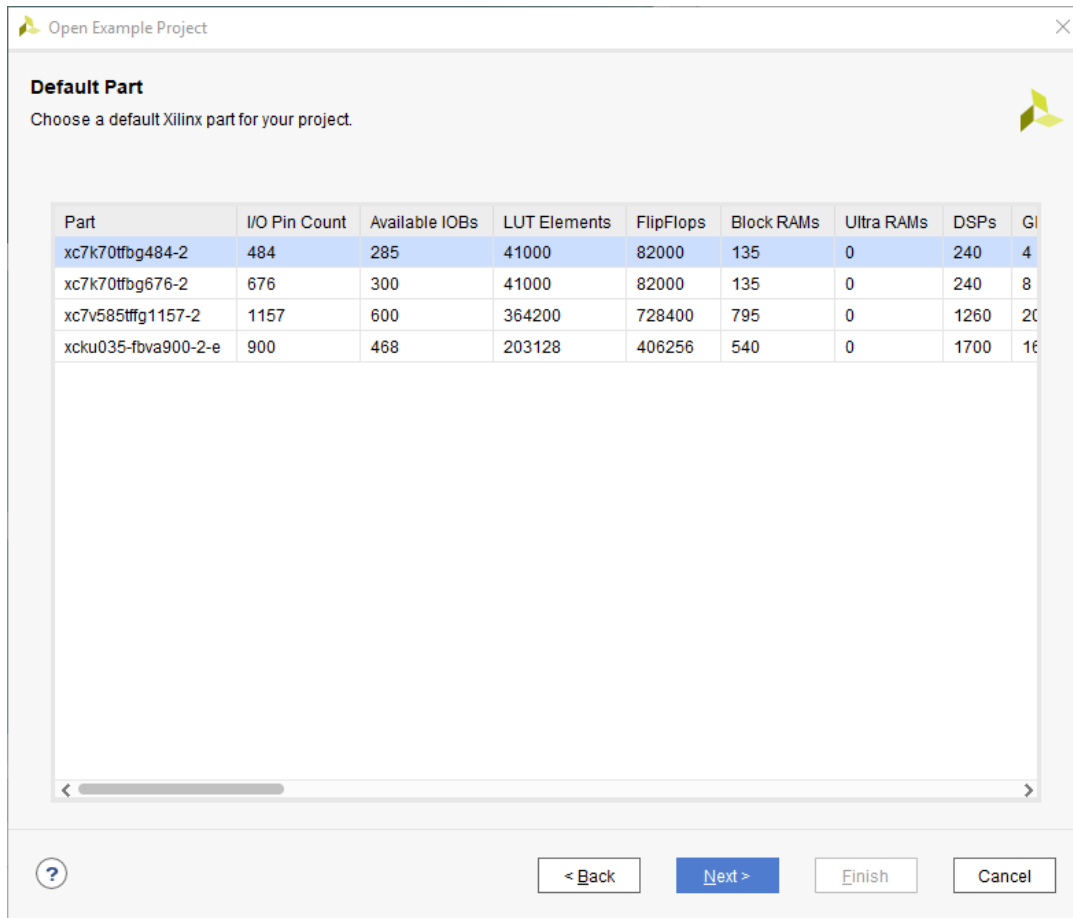

Figure 43: Open Example Project Wizard—Default Part Screen

7. In the New Project Summary screen, review the project details, and click **Finish**.

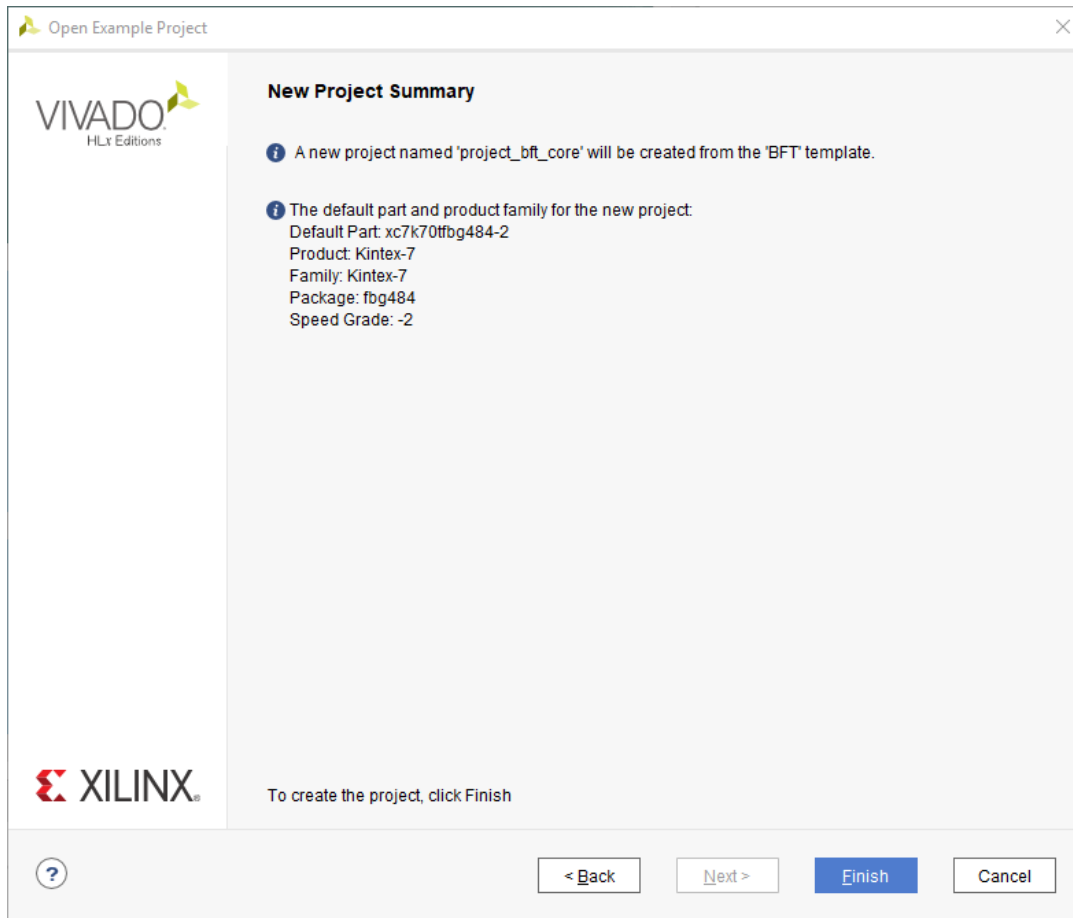

Figure 44: Open Example Project Wizard—New Project Summary Screen

The Vivado IDE opens with the default view.

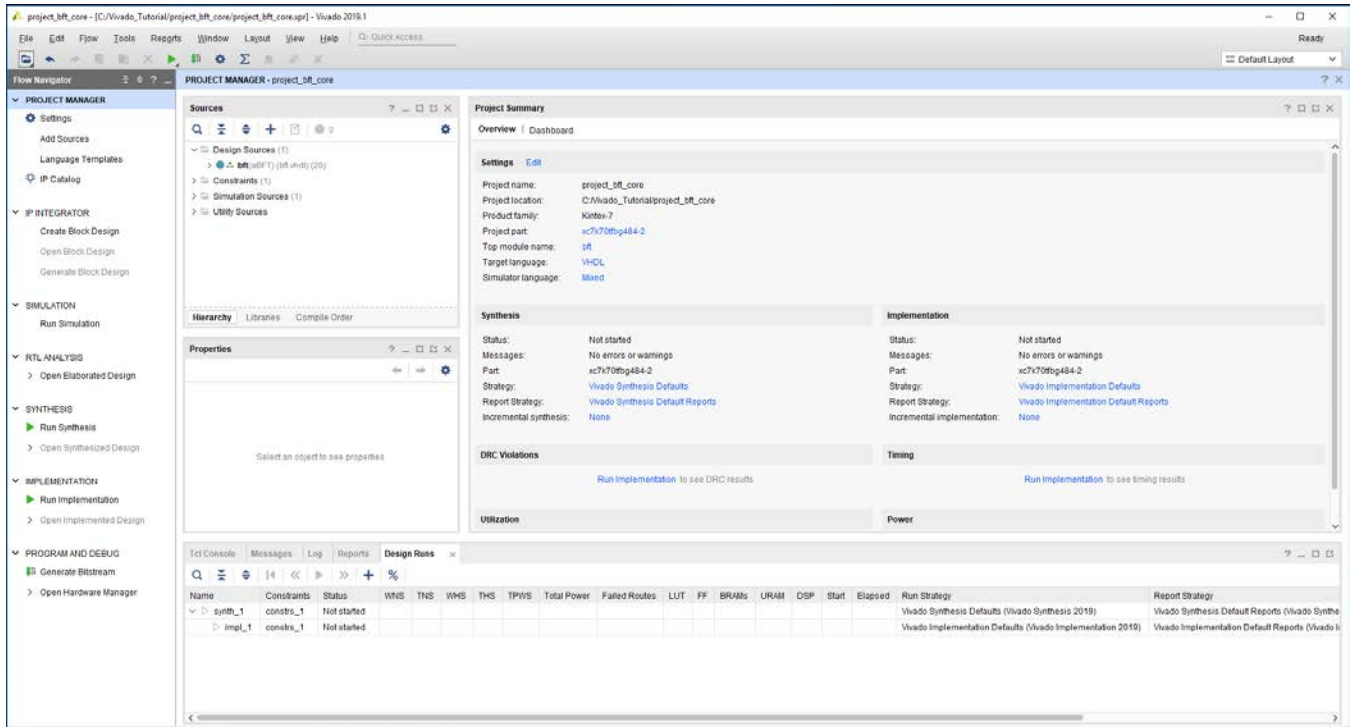

Figure 45: Vivado IDE Showing project_bft_core Project Details

Step 2: Performing Place and Route on the Design

1. In the Flow Navigator, click **Run Implementation**.

The Missing Synthesis Results dialog box opens to inform you that there is no synthesized netlist to implement, and prompts you to start synthesis first.

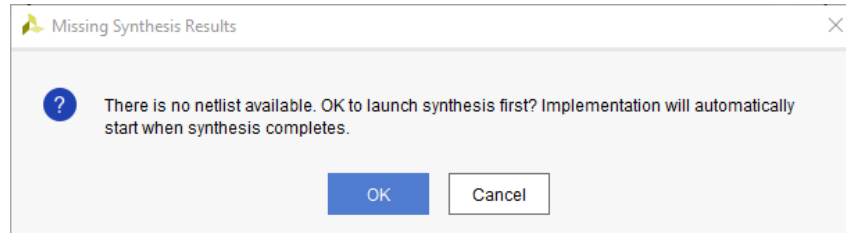

Figure 46: Missing Synthesis Results

2. Click **OK** to launch synthesis first.

Implementation automatically starts after synthesis completes, and the Implementation Completed dialog box opens when complete, as shown in the following figure.

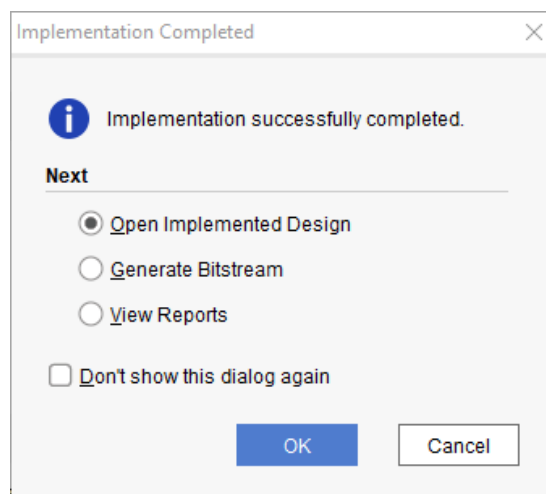



Figure 47: Implementation Completed

3. In the Implementation Completed dialog box, select **Open Implemented Design** and click **OK**. The Device window opens, displaying the placement results.
4. Click the **Routing Resources** button  to view the detailed routing resources in the Device window.

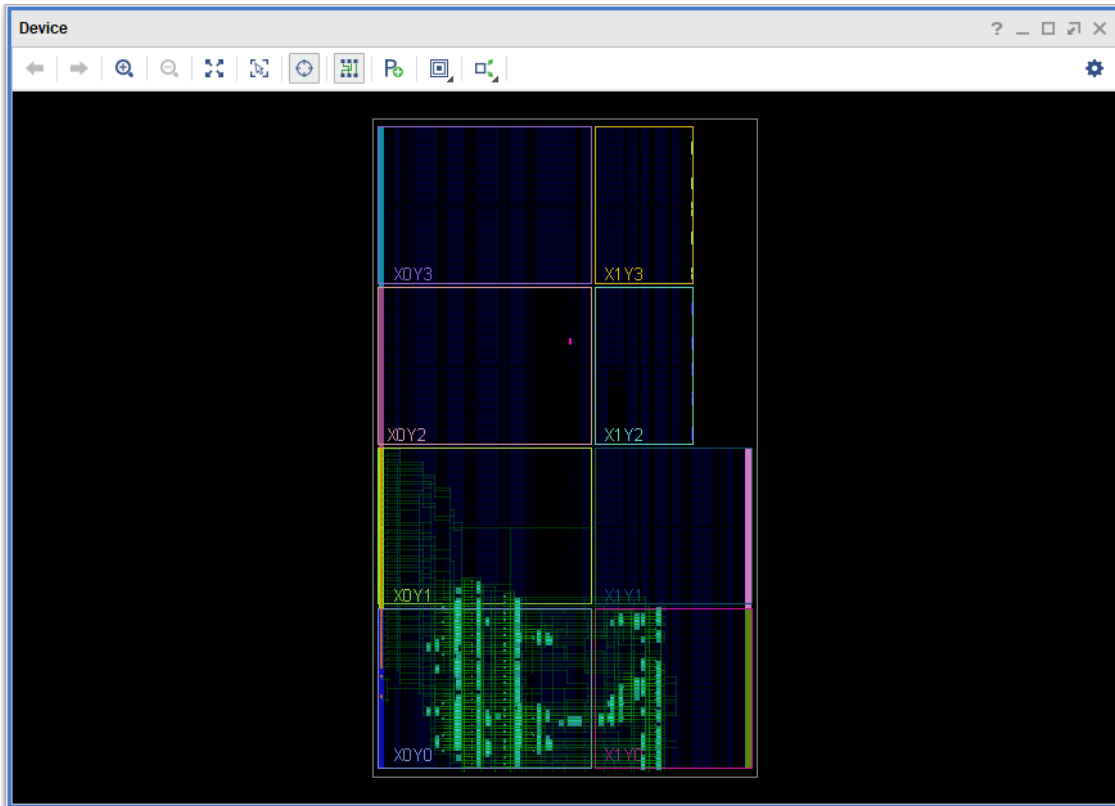

Figure 48: Device Window

Step 3: Analyzing Output Bus Timing



IMPORTANT: *The tutorial design has an output data bus, `wbOutputData`, which feeds external logic. Your objective is to precisely control timing skew by manually routing the nets of this bus.*

You can use the Report Datasheet command to analyze the current timing of members of the output bus, `wbOutputData`. The Report Datasheet command lets you analyze the timing of a group of ports with respect to a specific reference port.

1. From the main menu, select **Reports > Timing > Report Datasheet**.
2. Select the **Groups** tab in the Report Datasheet dialog box, as seen in the following figure, and enter the following:
 - o Reference: `[get_ports {wbOutputData[0]}]`
 - o Ports: `[get_ports {wbOutputData[*]}]`

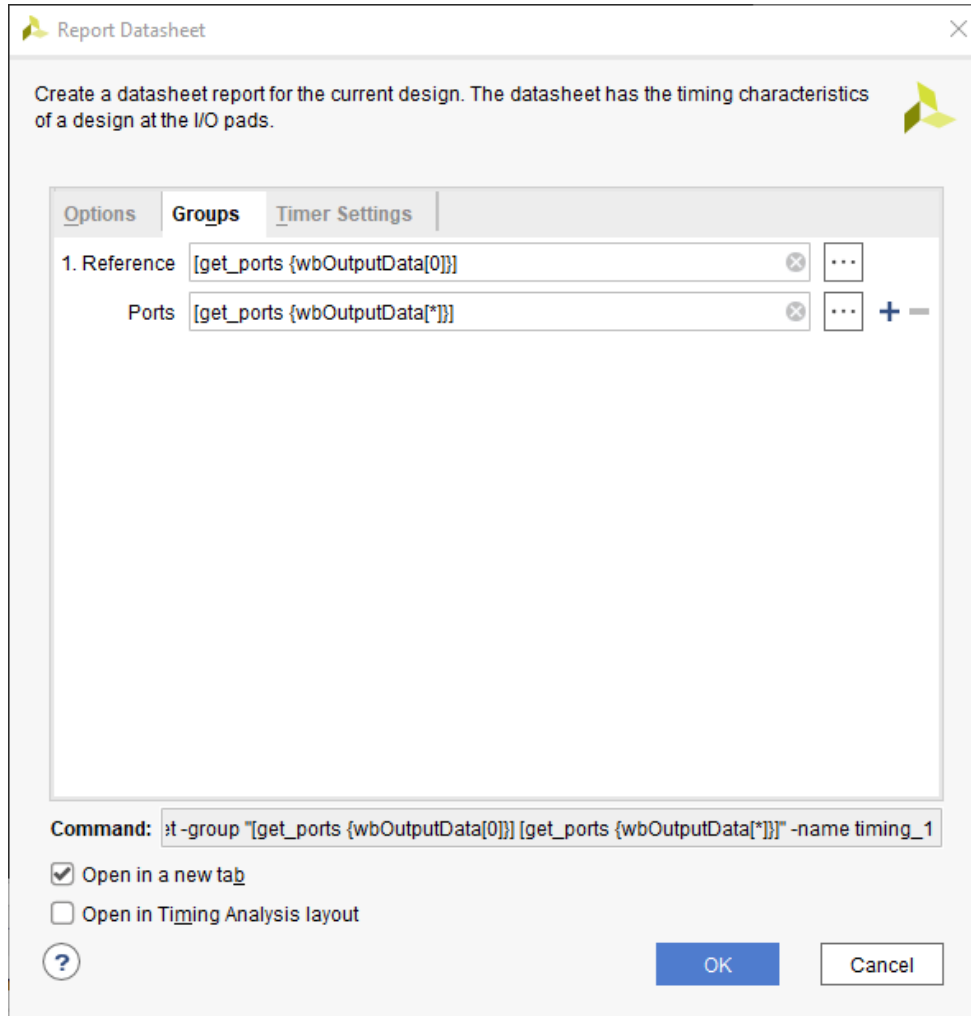

Figure 49: Report Datasheet

3. Click **OK**.

In this case, you are examining the timing at the ports carrying the `wbOutputData` bus, relative to the first bit of the bus, `wbOutputData[0]`. This allows you to quickly determine the relative timing differences between the different bits of the bus.

4. Click the **Maximize** button to maximize the **Timing - Datasheet** window and expand the results.
5. Select the Max/Min Delays for Groups > Clocked by `wbClk` > `wbOutputData[0]` section, as seen in the following figure.

You can see from the report that the timing skew across the `wbOutputData` bus varies by almost 660 ps. The goal is to minimize the skew across the bus to less than 100 ps.

Pad	Max Delay	Max Edge	Max Process Corner	Min Delay	Min Edge	Min Process Corner	E ...
wbOutputData[28]	9.281	Rise	SLOW	4.060	Rise	FAST	0.659
wbOutputData[31]	9.249	Rise	SLOW	4.054	Rise	FAST	0.627
wbOutputData[30]	9.226	Rise	SLOW	4.029	Rise	FAST	0.604
wbOutputData[27]	9.214	Rise	SLOW	4.023	Rise	FAST	0.592
wbOutputData[26]	9.202	Rise	SLOW	3.997	Rise	FAST	0.580
wbOutputData[24]	9.190	Rise	SLOW	3.998	Rise	FAST	0.568
wbOutputData[29]	9.130	Rise	SLOW	3.971	Rise	FAST	0.508
wbOutputData[23]	9.079	Rise	SLOW	3.949	Rise	FAST	0.457
wbOutputData[20]	9.011	Rise	SLOW	3.929	Rise	FAST	0.389
wbOutputData[25]	8.984	Rise	SLOW	3.897	Rise	FAST	0.362
wbOutputData[21]	8.962	Rise	SLOW	3.874	Rise	FAST	0.340
wbOutputData[22]	8.945	Rise	SLOW	3.870	Rise	FAST	0.323
wbOutputData[12]	8.828	Rise	SLOW	3.821	Rise	FAST	0.206
wbOutputData[18]	8.813	Rise	SLOW	3.784	Rise	FAST	0.191
wbOutputData[6]	8.801	Rise	SLOW	3.822	Rise	FAST	0.179
wbOutputData[9]	8.784	Rise	SLOW	3.801	Rise	FAST	0.162
wbOutputData[13]	8.771	Rise	SLOW	3.808	Rise	FAST	0.149
wbOutputData[19]	8.760	Rise	SLOW	3.773	Rise	FAST	0.138
wbOutputData[14]	8.747	Rise	SLOW	3.774	Rise	FAST	0.125
wbOutputData[11]	8.738	Rise	SLOW	3.782	Rise	FAST	0.116
wbOutputData[15]	8.722	Rise	SLOW	3.758	Rise	FAST	0.100
wbOutputData[1]	8.522	Rise	SLOW	3.645	Rise	FAST	0.100
wbOutputData[8]	8.717	Rise	SLOW	3.753	Rise	FAST	0.095
wbOutputData[16]	8.714	Rise	SLOW	3.753	Rise	FAST	0.092
wbOutputData[3]	8.534	Rise	SLOW	3.646	Rise	FAST	0.088
wbOutputData[10]	8.541	Rise	SLOW	3.667	Rise	FAST	0.081
wbOutputData[17]	8.687	Rise	SLOW	3.708	Rise	FAST	0.065
wbOutputData[7]	8.675	Rise	SLOW	3.736	Rise	FAST	0.053
wbOutputData[2]	8.674	Rise	SLOW	3.735	Rise	FAST	0.052
wbOutputData[4]	8.649	Rise	SLOW	3.709	Rise	FAST	0.028
wbOutputData[5]	8.642	Rise	SLOW	3.736	Rise	FAST	0.021
wbOutputData[0]	8.622	Rise	SLOW	3.716	Rise	FAST	0.000
Worst Case Summary	9.281	Rise	SLOW	3.645	Rise	FAST	0.659

Bus Skew: 0.659 ns

Figure 50: Report Datasheet Results

- Click the **Restore** button so you can simultaneously see the Device window and the Timing - Datasheet results.
- Click the hyperlink for the Max Delay of the source `wbOutputData[28]`. This highlights the path in the Device window that is currently open.

Note: Make sure that the **Autofit Selection**  is highlighted in the Device window so you can see the entire path, as shown in the following figure.

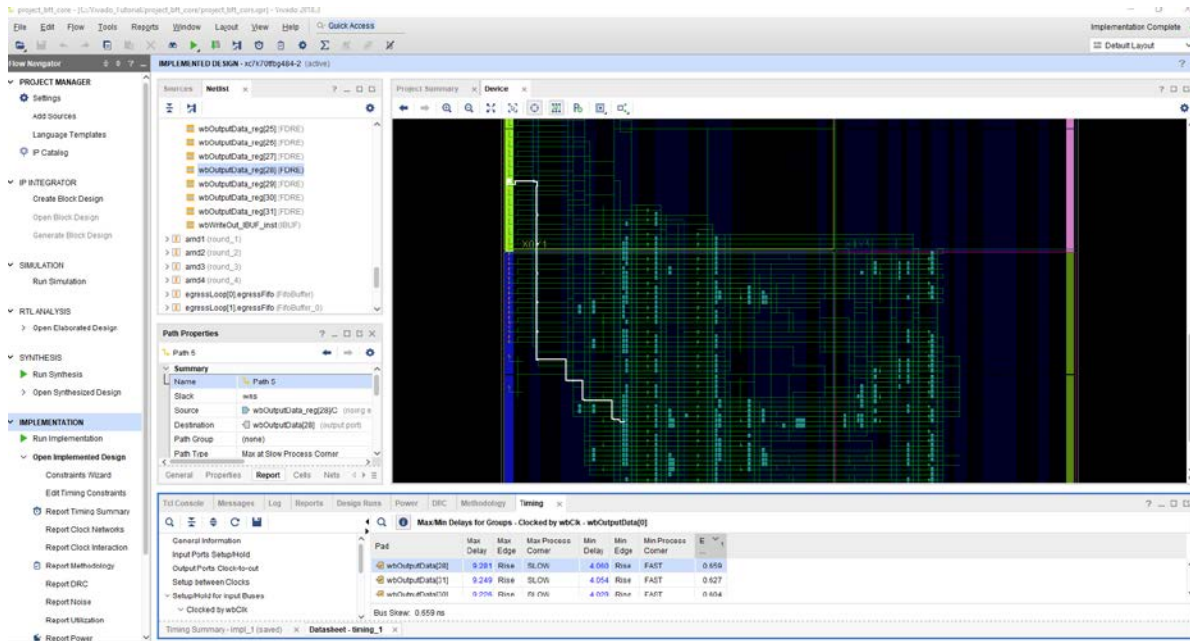

Figure 51: Detailed Routing View

- In the Device window, right click on the **highlighted path** and select **Schematic** from the popup menu.

This displays the schematic for the selected output data bus. From the schematic, you can see that the output port is directly driven from a register through an output buffer (OBUF).

If you can consistently control the placement of the register with respect to the output pins on the bus and control the routing between registers and the outputs, you can minimize skew between the members of the output bus.

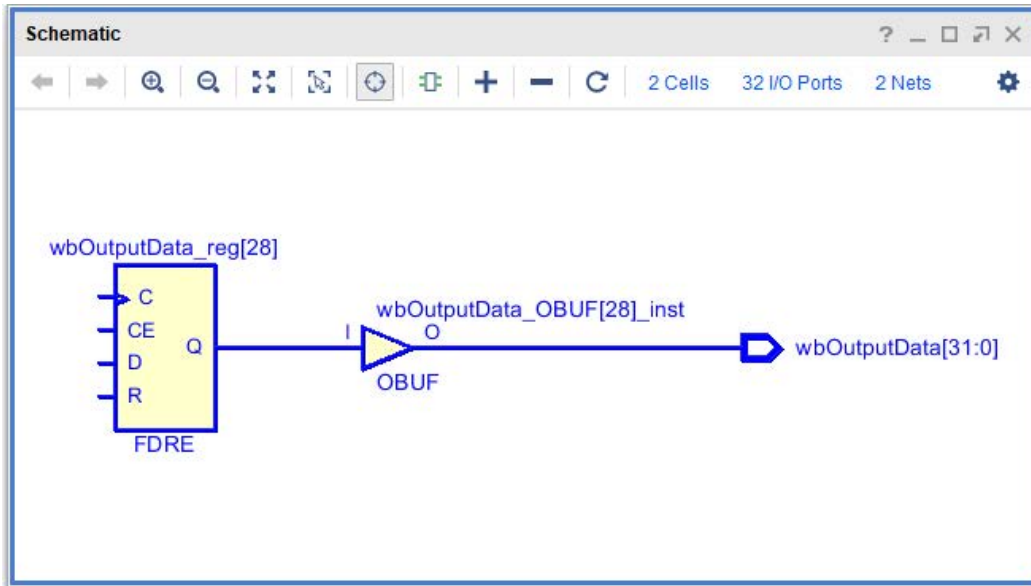

Figure 52: Schematic View of Output Path

9. Change to the Device window.

To better visualize the placement of the registers and outputs, you can use the `mark_objects` command to mark them in the Device window.

10. From the Tcl Console, type the following commands:

```
mark_objects -color blue [get_ports wbOutputData[*]]
mark_objects -color red [get_cells wbOutputData_reg[*]]
```

Blue diamond markers show on the output ports, and red diamond markers show on the registers feeding the outputs, as seen in the following figure.

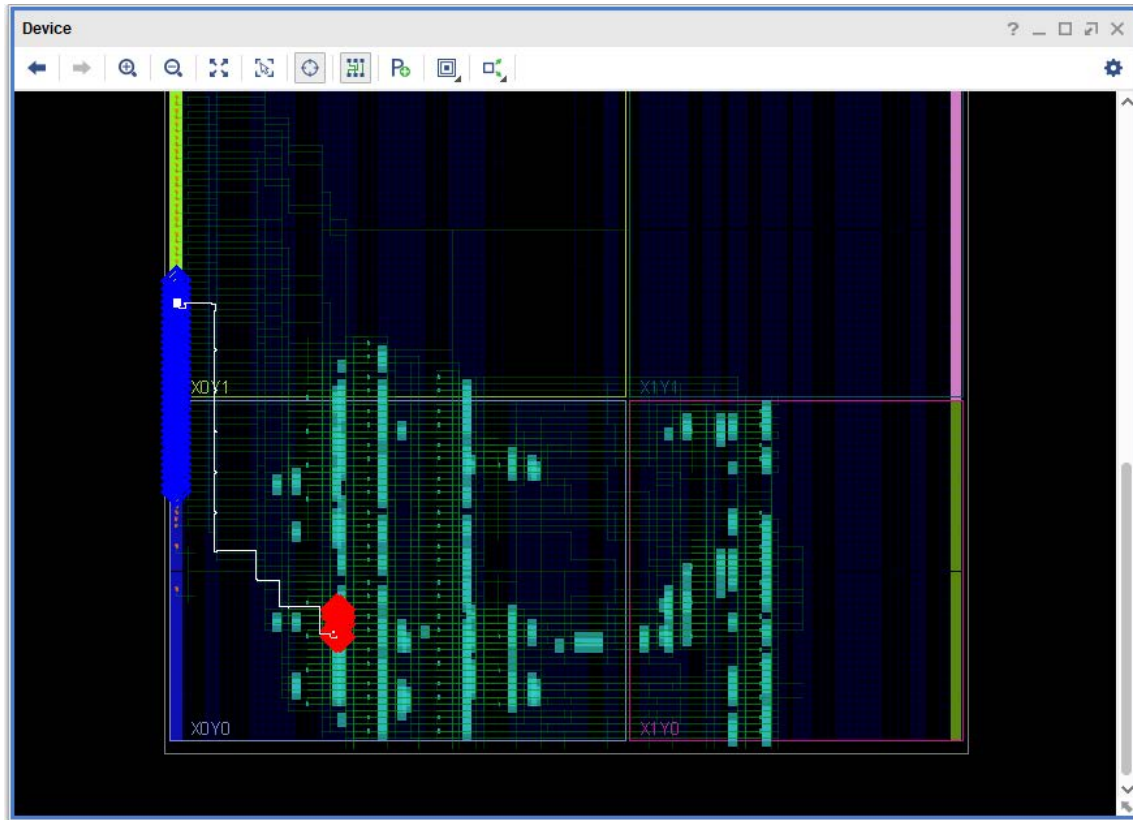

Figure 53: Marked Startpoints (red) and Endpoints (blue)

The outputs marked in blue are spread out along two banks on the left side starting with `wbOutputData[0]` (on the bottom) and ending with `wbOutputData[31]` (at the top), while the output registers marked in red are clustered close together on the right.

To look at all of the routing from the registers to the outputs, you can use the `highlight_objects` Tcl command to highlight the nets.

11. Type the following command at the Tcl prompt:

```
highlight_objects -color yellow [get_nets -of [get_pins -of [get_cells \
wbOutputData_reg[*]] -filter DIRECTION==OUT]]
```

This highlights all the nets connected to the output pins of the `wbOutputData_reg[*]` registers.

In the Device window, you can see that there are various routing distances between the clustered output registers and the distributed outputs pads of the bus. Consistently placing the output registers in the slices next to each output port eliminates a majority of the variability in the clock-to-out delay of the `wbOutputData` bus.

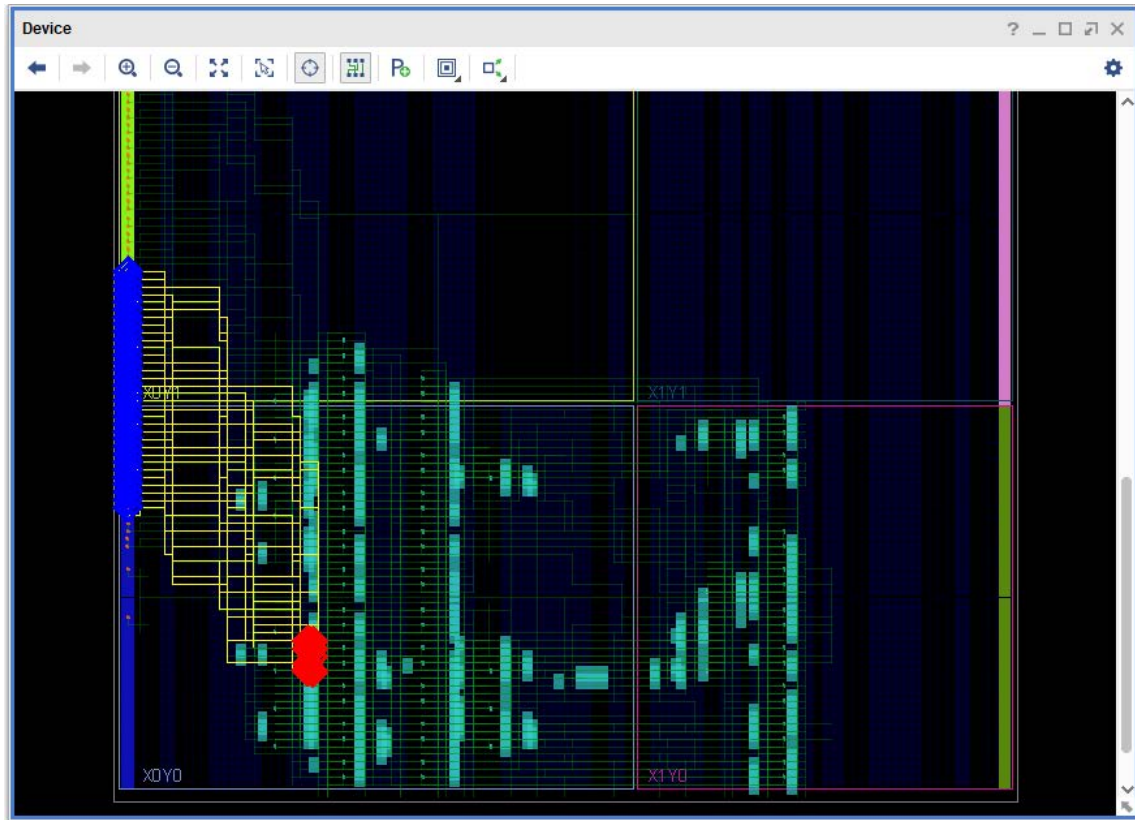

Figure 54: Highlighted Routes

12. In the main toolbar, click the **Unhighlight All** button  and the **Unmark All** button .

Step 4: Improving Bus Timing through Placement

To improve the timing of the `wbOutputData` bus you will place the output registers closer to their respective output pads, then rerun timing to look for any improvement. To place the output registers, you will identify potential placement sites, and then use a sequence of Tcl commands, or a Tcl script, to place the cells and reroute the connections.



RECOMMENDED: Use a series of Tcl commands to place the output registers in the slices next to the `wbOutPutData` bus output pads.

1. In the Device window click to disable **Routing Resources**  and make sure **AutoFit Selection**  is still enabled on the sidebar menu.

This lets you see placed objects more clearly in the Device window, without the added details of the routing.

2. Select the `wbOutputData` ports placed on the I/O blocks with the following Tcl command:

```
select_objects [get_ports wbOutputData*]
```

The Device window will show the selected ports highlighted in white, and zoom to fit the selection. By examining the device resources around the selected ports, you can identify a range of placement Sites for the output registers.

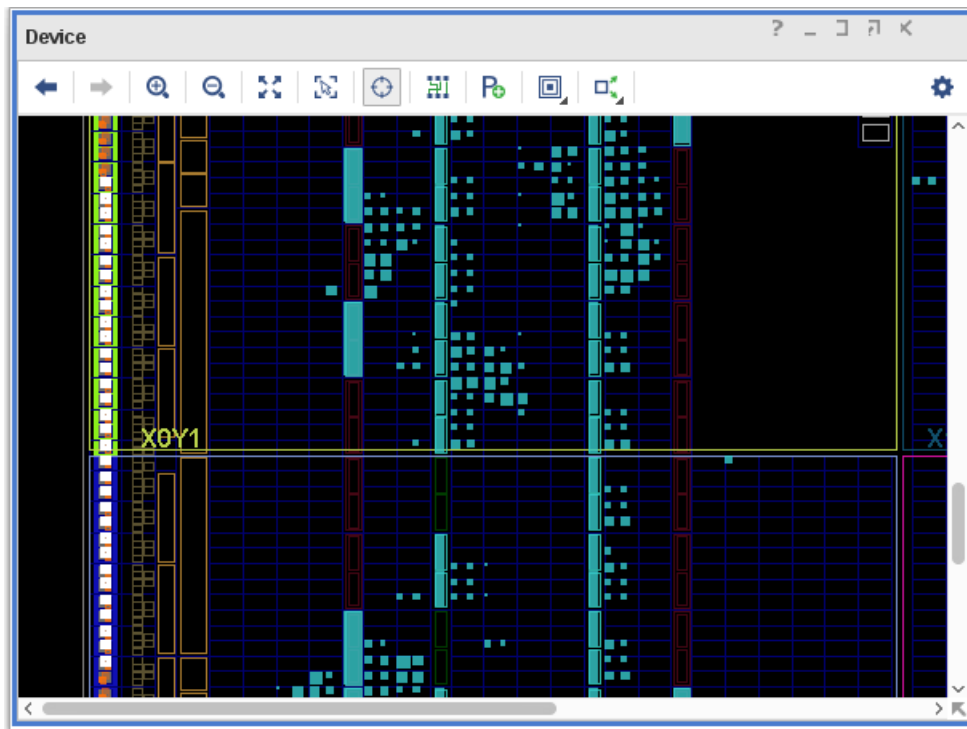

Figure 55: Selected `wbOutputData` Ports

- Zoom into the Device window around the bottom selected output ports. The following figure shows the results.

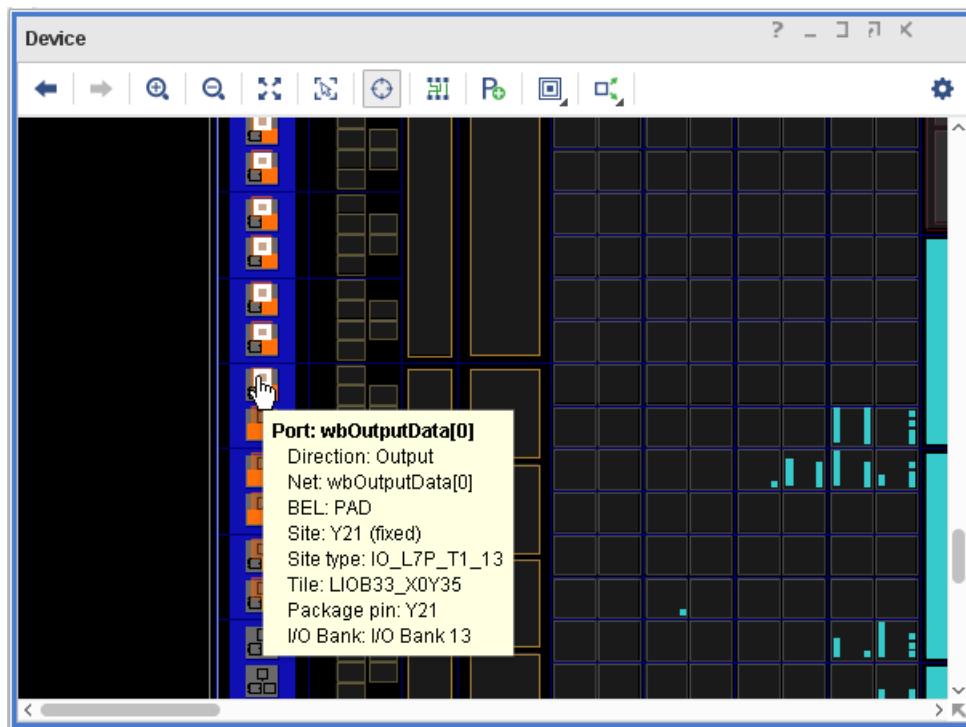

Figure 56: wbOutputData[0] Placement Details

The bottom ports are the lowest bits of the output bus, starting with `wbOutputData[0]`.

This port is placed on Package Pin Y21. Over to the right, where the Slice logic contains the device resources needed to place the output registers, the Slice coordinates are X0Y36. You will use that location as the starting placement for the 32 output registers, `wbOutputData_reg[31:0]`.

By scrolling or panning in the Device window, you can visually confirm that the highest output data port, `wbOutputData[31]`, is placed on Package Pin K22, and the registers to the right are in Slice X0Y67.

Now that you have identified the placement resources needed for the output registers, you must make sure they are available for placing the cells. You will do this by quickly unplacing the Slices to clear any currently placed logic.

- Unplace any cells currently assigned to the range of slices needed for the output registers, `SLICE_X0Y36` to `SLICE_X0Y67`, with the following Tcl command:

```
for {set i 0} {$i<32} {incr i} {
    unplace_cell [get_cells -of [get_sites SLICE_X0Y[expr 36 + $i]]]
}
```

This command uses a `for` loop with an index counter (`i`) and a Tcl expression (`36 + $i`) to get and unplace any cells found in the specified range of Slices. For more information on for loops and other scripting suggestions, refer to the *Vivado Design Suite User Guide: Using Tcl Scripting* (UG894).

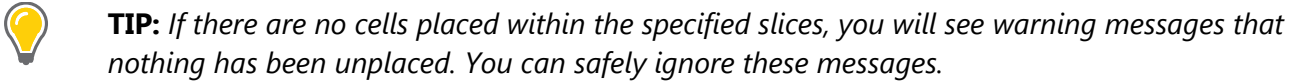
 **TIP:** *If there are no cells placed within the specified slices, you will see warning messages that nothing has been unplaced. You can safely ignore these messages.*

With the Slices cleared of any current logic cells, the needed resources are available for placing the output registers. After placing those, you will also need to replace any logic that was unplaced in the last step.

- Place the output registers, `wbOutputData_reg[31:0]`, in the specified Slice range with the following command:

```
for {set i 0} {$i<32} {incr i} {
    place_cell wbOutputData_reg[$i] SLICE_X0Y[expr 36 + $i]/AFF
}
```

- Now, place any remaining unplaced cells with the following command:

```
place_design
```

Note: *The Vivado placer works incrementally on a partially placed design.*

- As a precaution, unroute any nets connected to the output register cells, `wbOutputData_reg[31:0]`, using the following Tcl command:

```
route_design -unroute -nets [get_nets -of [get_cells wbOutputData_reg[*]]]
```

- Then route any currently unrouted nets in the design:

```
route_design
```

Note: *The Vivado router works incrementally on a partially routed design.*

- Analyze the route status of the current design to ensure that there are no routing conflicts:

```
report_route_status
```

- Click the **Routing Resources** button  to view the detailed routing resources in the Device window.

- Mark the output ports and registers again, and re-highlight the routing between them using the following Tcl commands:

```
mark_objects -color blue [get_ports wbOutputData[*]]
mark_objects -color red [get_cells wbOutputData_reg[*]]
highlight_objects -color yellow [get_nets -of [get_pins -of [get_cells\
wbOutputData_reg[*]] -filter DIRECTION==OUT]]
```

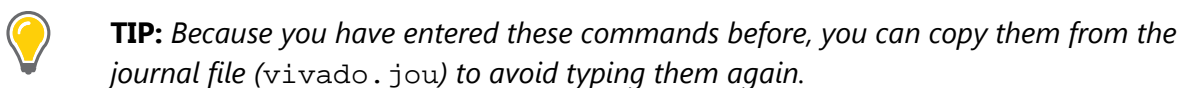
 **TIP:** *Because you have entered these commands before, you can copy them from the journal file (`vivado.jou`) to avoid typing them again.*

12. In the Device window, zoom into some of the marked output ports.
13. Select the nets connecting to them.



TIP: You can also select the nets in the Netlist window, and they will be cross-selected in the Device window.

In the Device window, you can see that all output registers are now placed equidistant from their associated outputs, and the routing path is very similar for all the nets from output register to output. This results in clock-to-out times that are closely matched between the outputs.

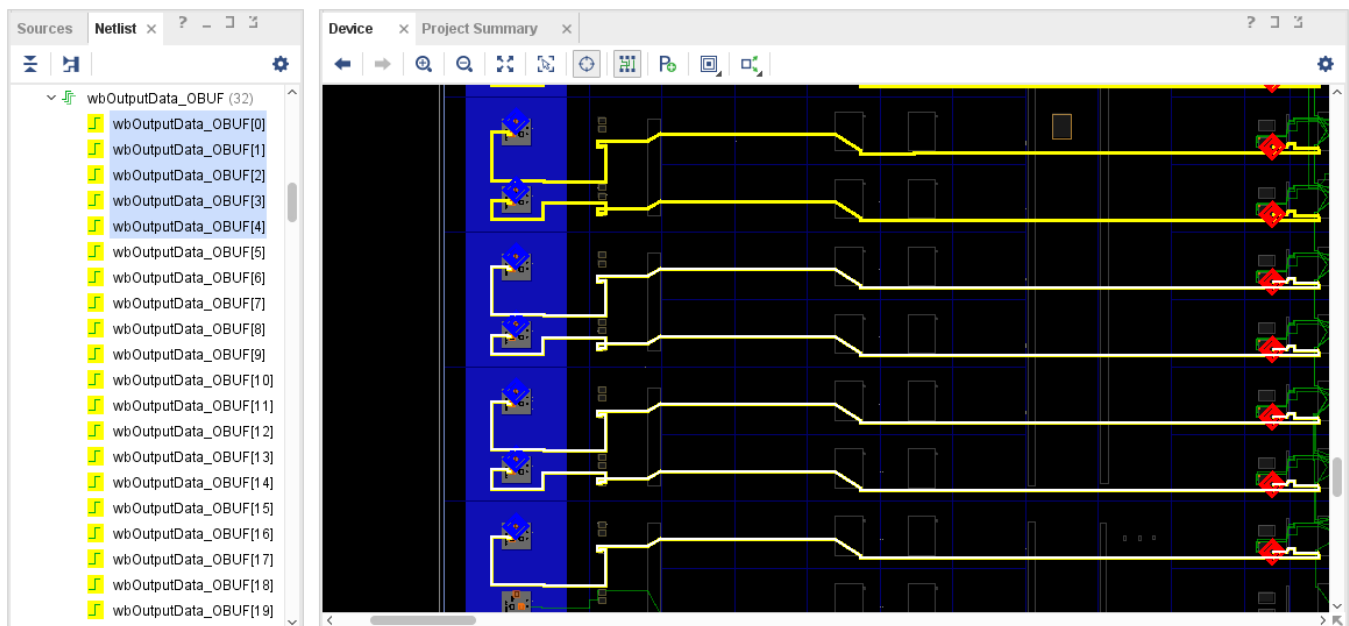

Figure 57: Improved Placement and Routing

14. Run the **Reports > Timing > Report Datasheet** command again.

The Report Datasheet dialog box is populated with settings from the last time you ran it:

- o Reference: [get_ports {wbOutputData[0]}]
- o Ports: [get_ports {wbOutputData[*]}]

15. In the Report Datasheet results, select the Max/Min Delays for Groups > Clocked by wbClk > wbOutputData[0] section.

Examining the results, the timing skew is closely matched within both the lower bits, `wbOutputData[0-13]`, and the upper bits, `wbOutputData[14-31]`, of the output bus. While the overall skew is reduced, it is still over 200 ps between the upper and lower bits.

With the improved placement, the skew is now a result of the output ports and registers spanning two clock regions, X0Y0 and X0Y1, which introduces clock network skew. Looking at the `wbOutputData` bus, notice that the Max delay is greater on the lower bits than it is on the upper bits. To reduce the skew, add delay to the upper bits.

You can eliminate some of the skew using a BUFMR/BUFR combination instead of a BUFG, to clock the output registers. However, for this tutorial, you will use manual routing to add delay from the output registers clocked by the BUFG to the output pins for the upper bits, `wbOutputData[14-31]`, to further reduce the clock-to-out variability within the bus.

Timing

Max/Min Delays for Groups - Clocked by wbClk - wbOutputData[0]

Pad	Max Delay	Max Edge	Max Process Corner	Min Delay	Min Edge	Min Process Corner	Edge Skew
wbOutputData[0]	7.911	Rise	SLOW	3.303	Rise	FAST	0.000
wbOutputData[31]	7.720	Rise	SLOW	3.236	Rise	FAST	0.190
wbOutputData[30]	7.697	Rise	SLOW	3.213	Rise	FAST	0.213
wbOutputData[29]	7.705	Rise	SLOW	3.221	Rise	FAST	0.205
wbOutputData[28]	7.707	Rise	SLOW	3.222	Rise	FAST	0.204
wbOutputData[27]	7.715	Rise	SLOW	3.228	Rise	FAST	0.196
wbOutputData[26]	7.688	Rise	SLOW	3.201	Rise	FAST	0.223
wbOutputData[25]	7.694	Rise	SLOW	3.208	Rise	FAST	0.217
wbOutputData[24]	7.695	Rise	SLOW	3.208	Rise	FAST	0.215
wbOutputData[23]	7.701	Rise	SLOW	3.214	Rise	FAST	0.210
wbOutputData[22]	7.687	Rise	SLOW	3.200	Rise	FAST	0.224
wbOutputData[21]	7.691	Rise	SLOW	3.203	Rise	FAST	0.220
wbOutputData[20]	7.723	Rise	SLOW	3.236	Rise	FAST	0.188
wbOutputData[19]	7.730	Rise	SLOW	3.242	Rise	FAST	0.181
wbOutputData[18]	7.678	Rise	SLOW	3.191	Rise	FAST	0.233
wbOutputData[17]	7.681	Rise	SLOW	3.193	Rise	FAST	0.230
wbOutputData[16]	7.718	Rise	SLOW	3.231	Rise	FAST	0.193
wbOutputData[15]	7.723	Rise	SLOW	3.236	Rise	FAST	0.188
wbOutputData[14]	7.755	Rise	SLOW	3.268	Rise	FAST	0.156
wbOutputData[13]	7.942	Rise	SLOW	3.336	Rise	FAST	0.032
wbOutputData[12]	7.891	Rise	SLOW	3.284	Rise	FAST	0.019
wbOutputData[11]	7.897	Rise	SLOW	3.290	Rise	FAST	0.014
wbOutputData[10]	7.905	Rise	SLOW	3.297	Rise	FAST	0.007
wbOutputData[9]	7.914	Rise	SLOW	3.306	Rise	FAST	0.004
wbOutputData[8]	7.886	Rise	SLOW	3.278	Rise	FAST	0.025
wbOutputData[7]	7.881	Rise	SLOW	3.274	Rise	FAST	0.030
wbOutputData[6]	7.915	Rise	SLOW	3.306	Rise	FAST	0.004
wbOutputData[5]	7.919	Rise	SLOW	3.311	Rise	FAST	0.008
wbOutputData[4]	7.868	Rise	SLOW	3.261	Rise	FAST	0.043
wbOutputData[3]	7.874	Rise	SLOW	3.267	Rise	FAST	0.037
wbOutputData[2]	7.875	Rise	SLOW	3.269	Rise	FAST	0.035
wbOutputData[1]	7.878	Rise	SLOW	3.271	Rise	FAST	0.033
wbOutputData[0]	7.911	Rise	SLOW	3.303	Rise	FAST	0.000
Worst Case Summary	7.942	Rise	SLOW	3.191	Rise	FAST	0.233

Bus Skew: 0.233 ns

Datasheet - timing_2

Figure 58: Report Datasheet—Improved Skew

Step 5: Using Manual Routing to Reduce Clock Skew

To adjust the skew, begin by examining the current routing of the nets, `wbOutputData_OBUF[14:31]`, to see where changes might be made to consistently add delay. You can use a Tcl FOR loop to report the existing routing on those nets, to let you examine them more closely.

1. In the Tcl Console, type the following command:

```
for {set i 14} {$i<32} {incr i} {
    puts "$i [get_property ROUTE [get_nets -of [get_pins -of \
        [get_cells wbOutputData_reg[$i]] -filter DIRECTION==OUT]]]"
}
```

This For loop initializes the index to 14 (`set i 14`), and gets the `ROUTE` property to return the details of the route on each selected net.

The Tcl Console returns the net index followed by relative route information for each net:

```
14 { CLBLL_LL_AQ CLBLL_LOGIC_OUTS4 WW2BEG0 IMUX_L34 IOI_OLOGIC0_D1 LIOI_OLOGIC0_OQ LIOI_O0 }
15 { CLBLL_LL_AQ CLBLL_LOGIC_OUTS4 WW2BEG0 IMUX_L34 IOI_OLOGIC1_D1 LIOI_OLOGIC1_OQ LIOI_O1 }
16 { CLBLL_LL_AQ CLBLL_LOGIC_OUTS4 WW2BEG0 IMUX_L34 IOI_OLOGIC0_D1 LIOI_OLOGIC0_OQ LIOI_O0 }
17 { CLBLL_LL_AQ CLBLL_LOGIC_OUTS4 WW2BEG0 IMUX_L34 IOI_OLOGIC1_D1 LIOI_OLOGIC1_OQ LIOI_O1 }
18 { CLBLL_LL_AQ CLBLL_LOGIC_OUTS4 WW2BEG0 IMUX_L34 IOI_OLOGIC0_D1 LIOI_OLOGIC0_OQ LIOI_O0 }
19 { CLBLL_LL_AQ CLBLL_LOGIC_OUTS4 WW2BEG0 IMUX_L34 IOI_OLOGIC1_D1 LIOI_OLOGIC1_OQ LIOI_O1 }
20 { CLBLL_LL_AQ CLBLL_LOGIC_OUTS4 WW2BEG0 IMUX_L34 IOI_OLOGIC0_D1 LIOI_OLOGIC0_OQ LIOI_O0 }
21 { CLBLL_LL_AQ CLBLL_LOGIC_OUTS4 WW2BEG0 IMUX_L34 IOI_OLOGIC1_D1 LIOI_OLOGIC1_OQ LIOI_O1 }
22 { CLBLL_LL_AQ CLBLL_LOGIC_OUTS4 WW2BEG0 IMUX_L34 IOI_OLOGIC0_D1 LIOI_OLOGIC0_OQ LIOI_O0 }
23 { CLBLL_LL_AQ CLBLL_LOGIC_OUTS4 WW2BEG0 IMUX_L34 IOI_OLOGIC1_D1 LIOI_OLOGIC1_OQ LIOI_O1 }
24 { CLBLL_LL_AQ CLBLL_LOGIC_OUTS4 WW2BEG0 IMUX_L34 IOI_OLOGIC0_D1 LIOI_OLOGIC0_OQ LIOI_O0 }
25 { CLBLL_LL_AQ CLBLL_LOGIC_OUTS4 WW2BEG0 IMUX_L34 IOI_OLOGIC1_D1 LIOI_OLOGIC1_OQ LIOI_O1 }
26 { CLBLL_LL_AQ CLBLL_LOGIC_OUTS4 WW2BEG0 IMUX_L34 IOI_OLOGIC0_D1 LIOI_OLOGIC0_OQ LIOI_O0 }
27 { CLBLL_LL_AQ CLBLL_LOGIC_OUTS4 WW2BEG0 IMUX_L34 IOI_OLOGIC1_D1 LIOI_OLOGIC1_OQ LIOI_O1 }
28 { CLBLL_LL_AQ CLBLL_LOGIC_OUTS4 WW2BEG0 IMUX_L34 IOI_OLOGIC0_D1 LIOI_OLOGIC0_OQ LIOI_O0 }
29 { CLBLL_LL_AQ CLBLL_LOGIC_OUTS4 WW2BEG0 IMUX_L34 IOI_OLOGIC1_D1 LIOI_OLOGIC1_OQ LIOI_O1 }
30 { CLBLL_LL_AQ CLBLL_LOGIC_OUTS4 WW2BEG0 IMUX_L34 IOI_OLOGIC0_D1 LIOI_OLOGIC0_OQ LIOI_O0 }
31 { CLBLL_LL_AQ CLBLL_LOGIC_OUTS4 WW2BEG0 IMUX_L34 IOI_OLOGIC1_D1 LIOI_OLOGIC1_OQ LIOI_O1 }
```

From the returned `ROUTE` properties, note that the nets are routed from the output registers using identical resources, up to node `IMUX_L34`. Beyond that, the Vivado router uses different nodes for odd and even index nets to complete the connection to the die pad.

By reusing routing paths, you can manually route one net with an even index, like `wbOutputData_OBUF[14]`, and one net with an odd index, such as `wbOutputData_OBUF[15]`, and copy the routing to all other even and odd index nets in the group.

2. In the Tcl Console, select the first net with the following command:

```
select_objects [get_nets -of [get_pins -of \
    [get_cells wbOutputData_reg[14]] -filter DIRECTION==OUT]]
```

3. In the Device window, right-click to open the popup menu and select **Unroute**.
4. Click **Yes** in the Confirm Unroute dialog box.

The Device window displays the unrouted net as a fly-line between the register and the output pad.

5. Click the **Maximize** button to maximize the Device window.

- Right-click the net and select **Enter Assign Routing Mode**.

The Target Load Cell Pin dialog box opens, as seen in [Figure 60](#), to let you select a load pin to route to or from. In this case, only one load pin populates: `wbOutputData_OBUF[14]_inst`.

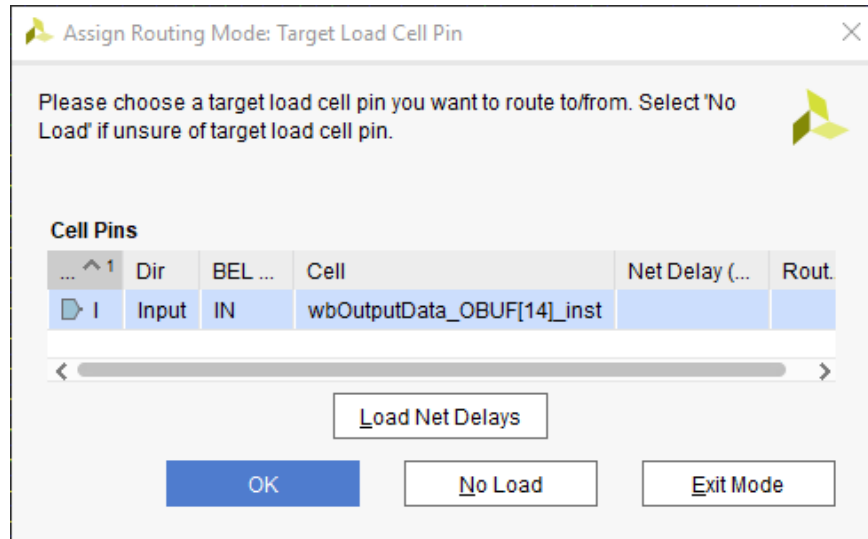

Figure 59: Target Load Cell Pin Dialog Box

- Select the **load cell pin `wbOutputData_OBUF[14]_inst/I`**, and click **OK**.

The Vivado IDE enters into Assign Routing mode, displaying a new Routing Assignment window on the right side of the Device window, as shown in the following figure.

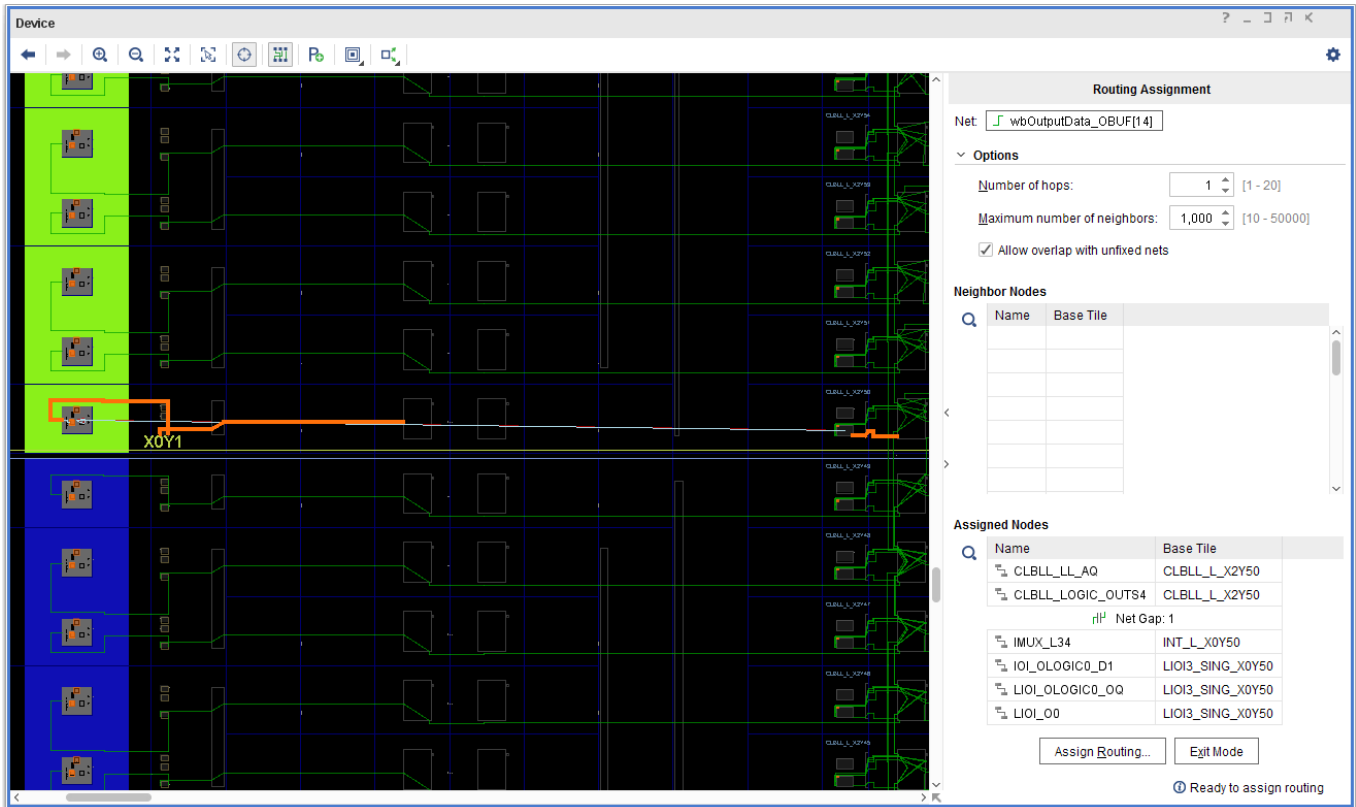

Figure 60: Assign Routing Mode

The Routing Assignment window includes the following sections:

- **Net:** Displays the current net being routed.
- **Options:** Are hidden by default, and can be displayed by clicking **Options**.
 - **Number of Hops:** Defines how many programmable interconnect points, or PIPs, to look at when reporting the available neighbors. The default is 1.
 - **Number of Neighbors:** Limits the number of neighbors displayed for selection.
 - **Allow Overlap with Unfixed Nets:** Enables or disables a loose style of routing which can create conflicts that must be later resolved. The default is ON.
- **Neighbor Nodes:** Lists the available neighbor PIPs/nodes to choose from when defining the path of the route.
- **Assigned Nodes:** Shows the currently assigned nodes in the route path of the selected net.
- **Assign Routing:** Assigns the currently defined path in the Routing Assignment window as the route path for the selected net.
- **Exit Mode:** Closes the Routing Assignment window.

The Assigned Nodes section displays six currently assigned nodes. The Vivado router automatically assigns a node if it is the only neighbor of a selected node and there are no alternatives to the assigned nodes for the route. In the Device window, the assigned nodes appear as a partial route in orange.

In the currently selected net, `wbOutputData_OBUF[14]`, nodes `CLBLL_LL_AQ` and `CLBLL_LOGIC_OUTS4` are already assigned because they are the only neighbor nodes available to the output register, `wbOutputData_reg[14]`. The nodes `IMUX_L34`, `IOI_OLOGIC0_D1`, `LIOI_OLOGIC0_OQ`, and `LIOI_O0` are also already assigned because they are the only neighbor nodes available to the destination, the output buffer (OBUF).

A gap exists between the two routed portions of the path where there are multiple neighbors to choose from when defining a route. This gap is where you will use manual routing to complete the path and add the needed delay to balance the clock skew.

You can route the gap by selecting a node on either side of the gap and then choosing the neighbor node to assign the route to. Selecting the node displays possible neighbor nodes in the Neighbor Nodes section of the Routing Assignment window and appear as dashed white lines in the Device window.



TIP: *The number of reachable neighbor nodes displayed depends on the number of hops defined in the Options.*

- Under the **Assigned Nodes** section, select the CLBLL_LOGIC_OUTS4 node before the gap.
The available neighbors appear as shown in the following figure.

To add delay to compensate for the clock skew, select a neighbor node that provides a slight detour over the more direct route previously chosen by the router.

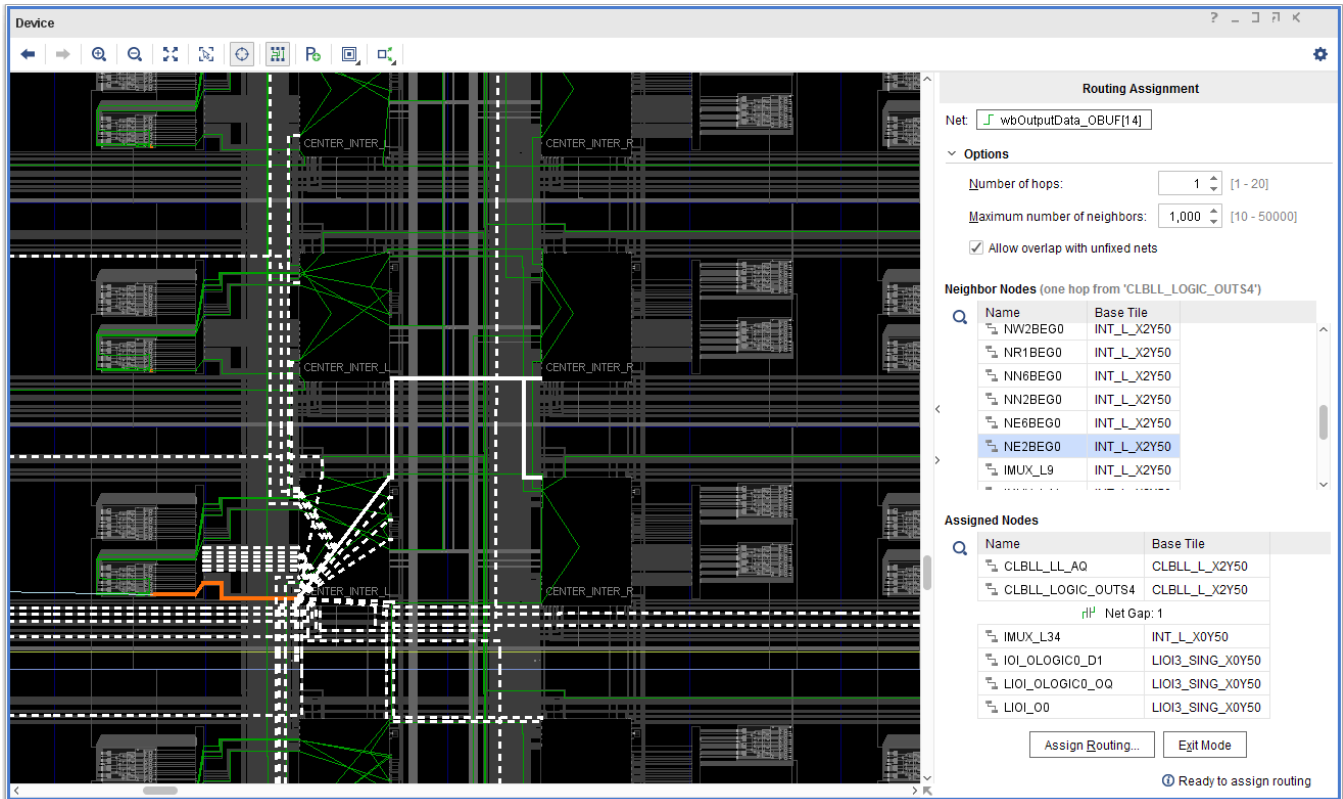



Figure 61: Routing the Gap from CLBLL_LOGIC_OUTS4

- Under **Neighbor Nodes**, select node NE2BEG0.
This node provides a routing detour to add delay, as compared to some other nodes such as WW2BEG0, which provide a more direct route toward the output buffer. Clicking a neighbor node once selects it so you can explore routing alternatives. Double-clicking the node temporarily assigns it to the net, so that you can then select the next neighbor from that node.
- In **Neighbor Nodes**, assign node NE2BEG0 by double-clicking it.
This adds the node to the Assigned Nodes section of the Routing Assignment window, which updates the Neighbor Nodes.

11. In **Neighbor Nodes**, select and assign nodes WR1BEG1, and then WR1BEG2.



TIP: In case you assigned the wrong node, you can select the node from the Assigned Nodes list, right click, and select **Remove** on the context menu.

You can turn off the Auto Fit Selection  in the Device window if you would like to stay at the same zoom level.

The following figure shows the partially routed path using the selected nodes shown in orange. You can use the automatic routing feature to fill the remaining gap.

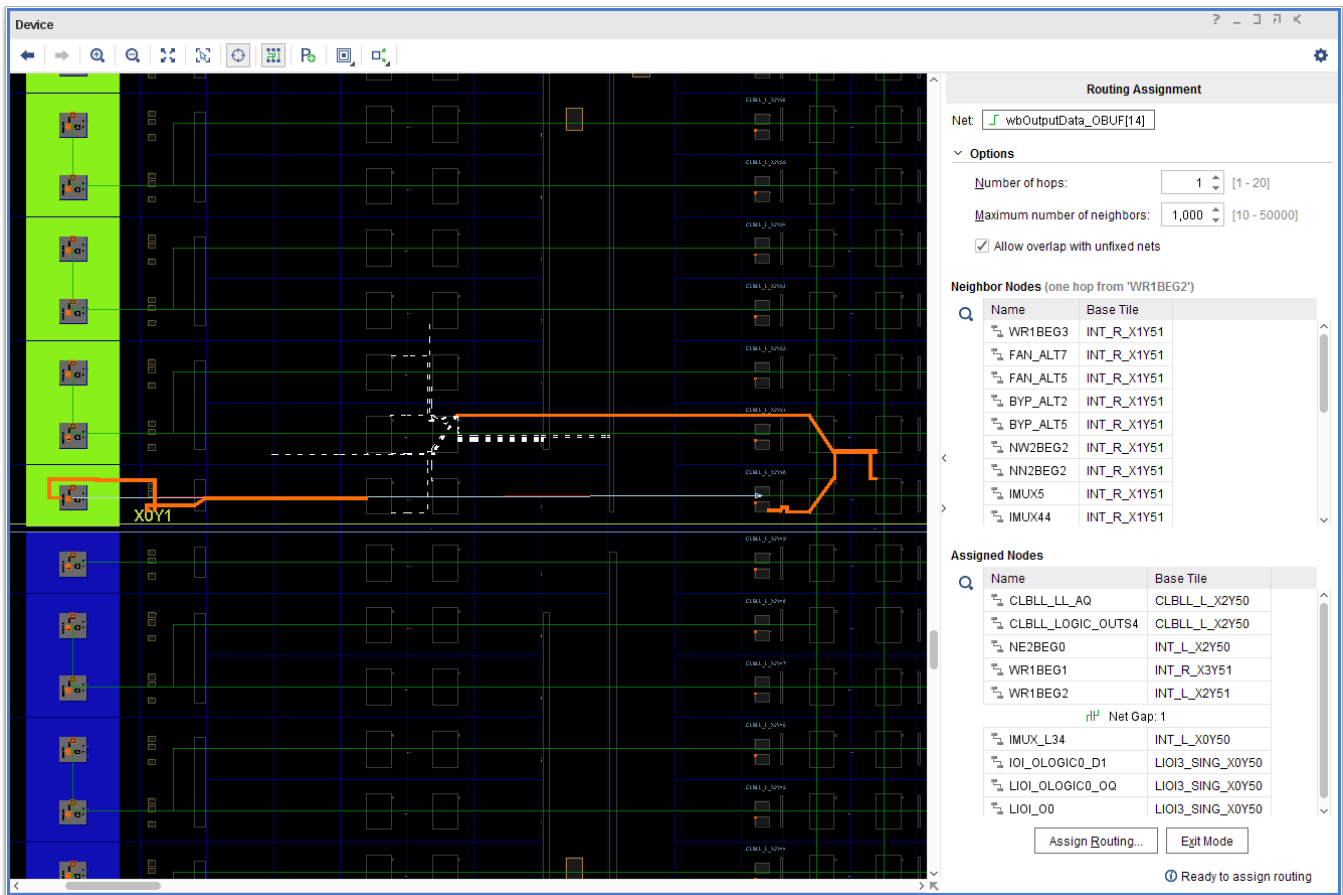

Figure 62: Closing the Gap

- Under the **Assigned Nodes** section of the Routing Assignment window, right-click the **Net Gap**, and select **Auto-Route**, as shown in the following figure.

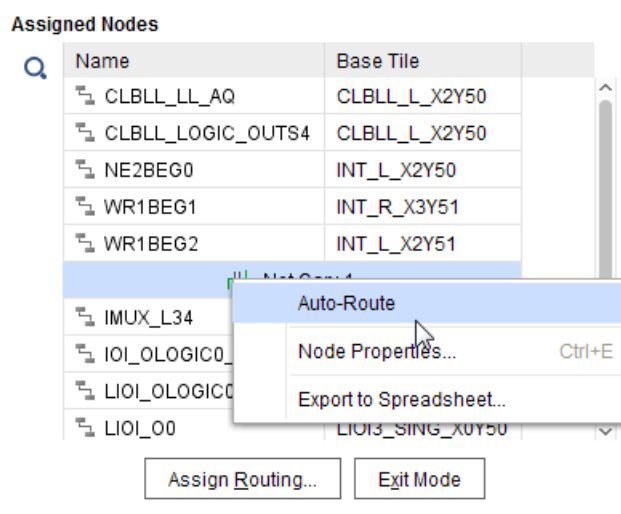

Figure 63: Auto-Route the Gap

The Vivado router fills in the last small bit of the gap. With the route path fully defined, you can assign the routing to commit the changes to the design.

- Click **Assign Routing** at the bottom of the Routing Assignment window.

The Assign Routing dialog box opens, as seen in the following figure. This displays the list of currently assigned nodes that define the route path. You can select any of the listed nodes, highlighting it in the Device window. This lets you quickly review the route path prior to committing it to the design.

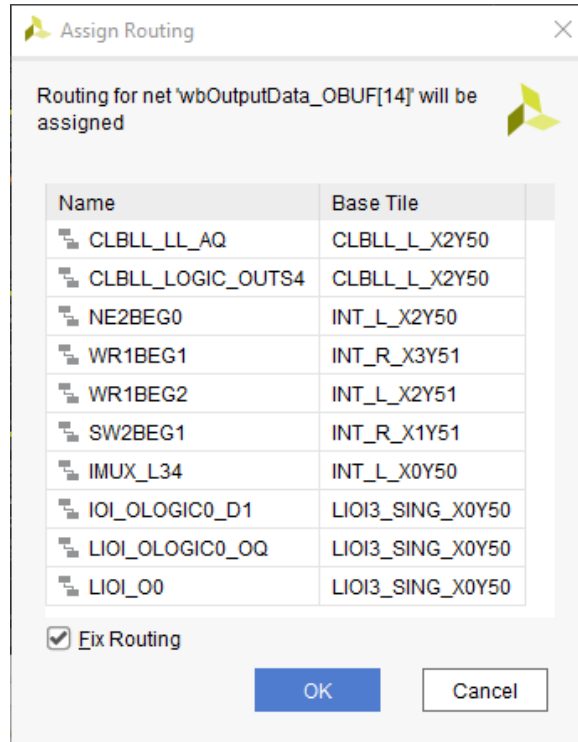

Figure 64: Assign Routing—Even Nets

14. Make sure **Fix Routing** is checked, and click **OK**.

The Fix Routing checkbox marks the defined route as fixed to prevent the Vivado router from ripping it up or modifying it during subsequent routing steps. This is important in this case, because you are routing the net manually to add delay to match clock skew.

15. Examine the Tcl commands in the Tcl Console.

The Tcl Console reports any Tcl commands that assigned the routing for the current net. Those commands are:

```
set_property is_bel_fixed 1 [get_cells {wbOutputData_reg[14]
wbOutputData_OBUF[14]_inst }]
set_property is_loc_fixed 1 [get_cells {wbOutputData_reg[14]
wbOutputData_OBUF[14]_inst }]
set_property fixed_route { { CLBLL_LL_AQ CLBLL_LOGIC_OUTS4 NE2BEG0 WR1BEG1
WR1BEG2 SW2BEG1 IMUX_L34 IOI_OLOGIC0_D1 LIOI_OLOGIC0_OQ LIOI_O0 } } [get_nets
{wbOutputData_OBUF[14]}]
```



IMPORTANT: The `FIXED_ROUTE` property assigned to the net, `wbOutputData_OBUF[14]`, uses a directed routing string with a relative format, based on the placement of the net driver. This lets you reuse defined routing by copying the `FIXED_ROUTE` property onto other nets that use the same relative route.

After defining the manual route for the even index nets, the next step is to define the route path for the odd index net, `wbOutputData_OBUF[15]`, applying the same steps you just completed.

16. In the Tcl Console type the following to select the net:

```
select_objects [get_nets wbOutputData_OBUF[15]]
```

17. With the net selected:

- a. Unroute the net.
- b. Enter Routing Assignment mode.
- c. Select the Load Cell Pin.
- d. Route the net using the specified neighbor nodes (`NE2BEG0`, `WR1BEG1`, and `WR1BEG2`).
- e. Auto-Route the gap.
- f. Assign the routing.

The Assign Routing dialog box, shown in the following figure, shows the nodes selected to complete the route path for the odd index nets.

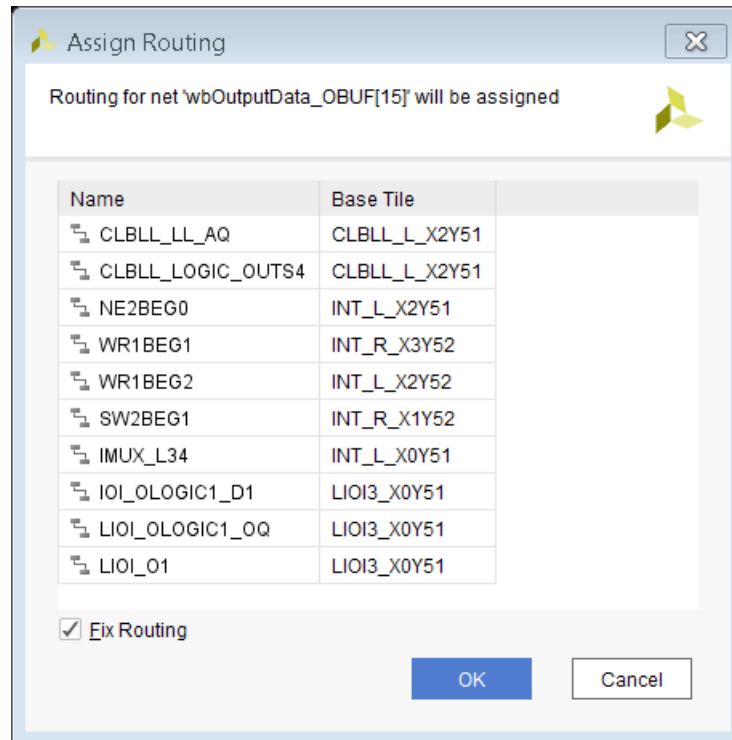

Figure 65: Assign Routing—Odd Nets

You routed the `wbOutputData_OBUF[14]` and `wbOutputData_OBUF[15]` nets with the detour to add the needed delay. You can now run the **Report Datasheet** command again to examine the timing for these nets with respect to the lower order bits of the bus.

18. Switch to the Timing Datasheet report window. Notice the information message in the banner of the window indicating that the report is out of date because the design was modified.
19. In the Timing Datasheet report, click **Rerun** to update the report with the latest timing information.
20. Select **Max/Min Delays for Groups > Clocked by wbClk > wbOutputData[0]** to display the timing info for the `wbOutputData` bus, as seen in Figure 66.

Timing

Max/Min Delays for Groups - Clocked by wbClk - wbOutputData[0]

Pad	Max Delay	Max Edge	Max Process Corner	Min Delay	Min Edge	Min Process Corner	Edge Skew
wbOutputData[31]	7.720	Rise	SLOW	3.236	Rise	FAST	0.190
wbOutputData[30]	7.697	Rise	SLOW	3.213	Rise	FAST	0.213
wbOutputData[29]	7.705	Rise	SLOW	3.221	Rise	FAST	0.205
wbOutputData[28]	7.707	Rise	SLOW	3.222	Rise	FAST	0.204
wbOutputData[27]	7.715	Rise	SLOW	3.228	Rise	FAST	0.196
wbOutputData[26]	7.688	Rise	SLOW	3.201	Rise	FAST	0.223
wbOutputData[25]	7.694	Rise	SLOW	3.208	Rise	FAST	0.217
wbOutputData[24]	7.695	Rise	SLOW	3.208	Rise	FAST	0.215
wbOutputData[23]	7.701	Rise	SLOW	3.214	Rise	FAST	0.210
wbOutputData[22]	7.687	Rise	SLOW	3.200	Rise	FAST	0.224
wbOutputData[21]	7.691	Rise	SLOW	3.203	Rise	FAST	0.220
wbOutputData[20]	7.723	Rise	SLOW	3.236	Rise	FAST	0.188
wbOutputData[19]	7.730	Rise	SLOW	3.242	Rise	FAST	0.181
wbOutputData[18]	7.678	Rise	SLOW	3.191	Rise	FAST	0.233
wbOutputData[17]	7.681	Rise	SLOW	3.193	Rise	FAST	0.230
wbOutputData[16]	7.718	Rise	SLOW	3.231	Rise	FAST	0.193
wbOutputData[15]	7.987	Rise	SLOW	3.366	Rise	FAST	0.076
wbOutputData[14]	7.949	Rise	SLOW	3.328	Rise	FAST	0.038
wbOutputData[13]	7.942	Rise	SLOW	3.336	Rise	FAST	0.032
wbOutputData[12]	7.891	Rise	SLOW	3.284	Rise	FAST	0.019
wbOutputData[11]	7.897	Rise	SLOW	3.290	Rise	FAST	0.014
wbOutputData[10]	7.905	Rise	SLOW	3.297	Rise	FAST	0.007
wbOutputData[9]	7.914	Rise	SLOW	3.306	Rise	FAST	0.004
wbOutputData[8]	7.886	Rise	SLOW	3.278	Rise	FAST	0.025
wbOutputData[7]	7.881	Rise	SLOW	3.274	Rise	FAST	0.030
wbOutputData[6]	7.915	Rise	SLOW	3.306	Rise	FAST	0.004
wbOutputData[5]	7.919	Rise	SLOW	3.311	Rise	FAST	0.008
wbOutputData[4]	7.868	Rise	SLOW	3.261	Rise	FAST	0.043
wbOutputData[3]	7.874	Rise	SLOW	3.267	Rise	FAST	0.037
wbOutputData[2]	7.875	Rise	SLOW	3.269	Rise	FAST	0.035
wbOutputData[1]	7.878	Rise	SLOW	3.271	Rise	FAST	0.033
wbOutputData[0]	7.911	Rise	SLOW	3.303	Rise	FAST	0.000
wbOutputData[0]	7.911	Rise	SLOW	3.303	Rise	FAST	0.000
Worst Case Summary	7.987	Rise	SLOW	3.191	Rise	FAST	0.233

Bus Skew: 0.233 ns

Datasheet - timing_2

Figure 66: Report Datasheet—Improved Routing

You can see from the report that the skew within the rerouted nets, wbOutputData[14] and wbOutputData[15], more closely matches the timing of the lower bits of the output bus,

wbOutputData[13:0]. The skew is within the target of 100 ps of the reference pin wbOutputData[0].

In Step 6, you copy the same route path to the remaining nets, wbOutputData_OBUF[31:16], to tighten the timing of the whole wbOutputData bus.

Step 6: Copying Routing to Other Nets

To apply the same fixed route used for net wbOutputData_OBUF[14] to the even index nets, and the fixed route for wbOutputData_OBUF[15] to the odd index nets, you can use Tcl For loops as described in the following steps.

1. Select the Tcl Console tab.
2. Set a Tcl variable to store the route path for the even nets and the odd nets:

```
set even [get_property FIXED_ROUTE [get_nets wbOutputData_OBUF[14]]]
set odd [get_property FIXED_ROUTE [get_nets wbOutputData_OBUF[15]]]
```

3. Set a Tcl variable to store the list of nets to be routed, containing all high bit nets of the output data bus, wbOutputData_OBUF[16:31]:

```
for {set i 16} {$i<32} {incr i} {
  lappend routeNets [get_nets wbOutputData_OBUF[$i]]
}
```

4. Unroute the specified nets:

```
route_design -unroute -nets $routeNets
```

5. Apply the FIXED_ROUTE property of net wbOutputData_OBUF[14] to the even nets:

```
for {set i 16} {$i<32} {incr i 2} {
  set_property FIXED_ROUTE $even [get_nets wbOutputData_OBUF[$i]]
}
```

6. Apply the FIXED_ROUTE property of net wbOutputData_OBUF[15] to the odd nets:

```
for {set i 17} {$i<32} {incr i 2} {
  set_property FIXED_ROUTE $odd [get_nets wbOutputData_OBUF[$i]]
}
```

The even and odd nets of the output data bus, as needed, now have the same routing paths, adding delay to the high order bits. Run the route status report and the datasheet report to validate that the design is as expected.

7. In the Tcl Console, type the following command:

```
report_route_status
```



TIP: Some routing errors might be reported if the routed design included nets that use some of the nodes you have assigned to the FIXED_ROUTE properties of the manually routed nets. Remember you enabled **Allow Overlap with Unfixed Nets** in the Routing Assignment window.

8. If any routing errors are reported, type the `route_design` command in the Tcl Console.
The nets with the `FIXED_ROUTE` property takes precedence over the auto-routed nets.
9. After `route_design`, repeat the `report_route_status` command to see the clean report.
10. Examine the output data bus in the Device window, as seen in the following figure:
 - All nets from the output registers to the output pins for the upper bits 14-31 of the output bus `wbOutputData` have identical fixed routing sections (shown as dashed lines).
 - You do not need to fix the `LOC` and the `BEL` for the output registers. It was done by the `place_cell` command in an earlier step.

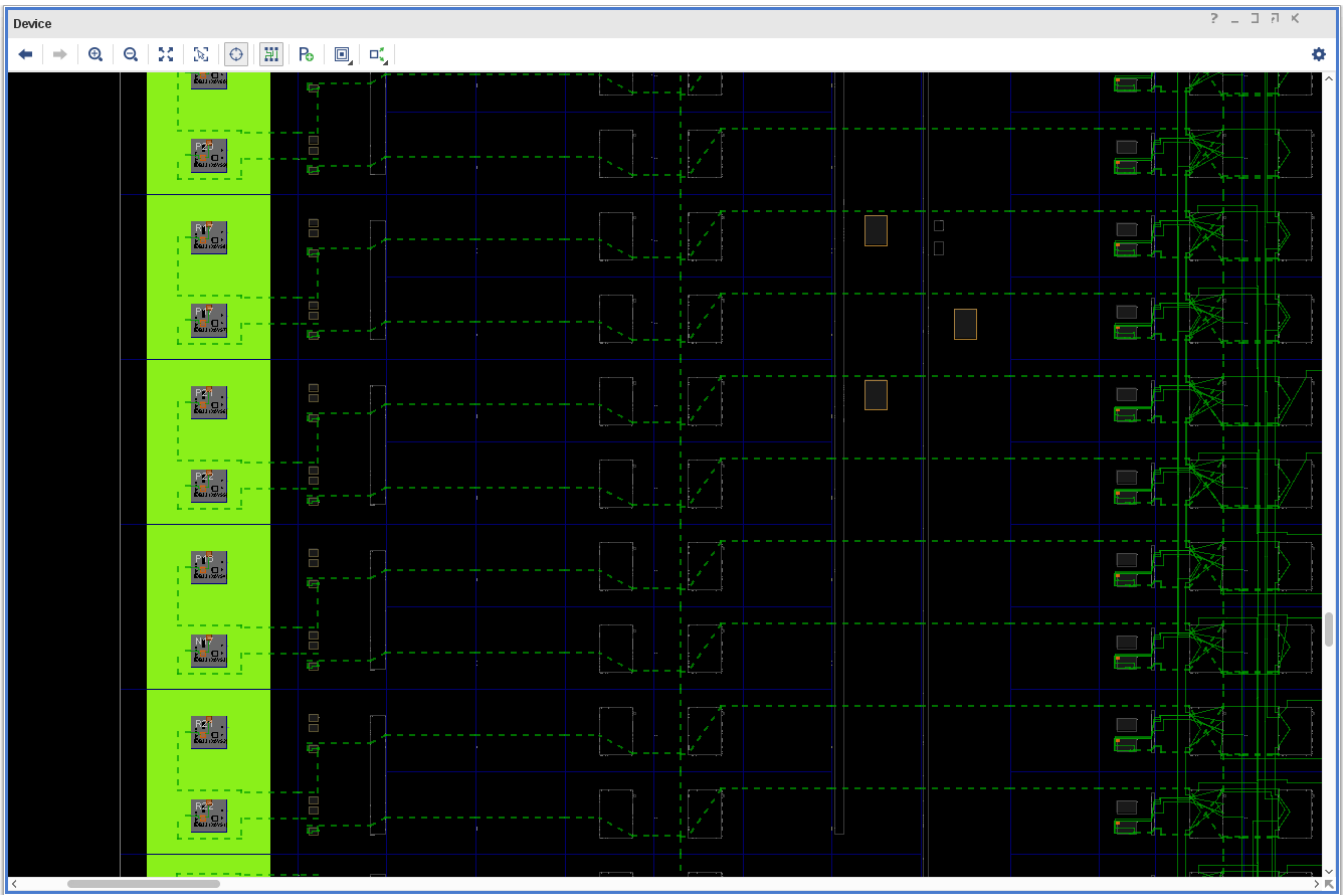

Figure 67: Final Routed Design

Having routed all the upper bit nets, `wbOutputData_OBUF[31:14]`, with the detour needed for added delay, you can now re-examine the timing of output bus.

11. Select the Timing tab in the Results window area.

Notice the information message in the banner of the window indicating that the report is out of date because timing data has been modified.

12. Click **rerun** to update the report with the latest timing information.

13. Select the **Max/Min Delays for Groups > Clocked by wbClk > wbOutputData[0]** section to display the timing info for the `wbOutputData` bus.

The clock-to-out timing within all bits of output bus `wbOutputData` is now closely matched to within 83 ps.

14. Save the constraints to write them to the target XDC, so that they apply every time you compile the design.
15. Select **File > Constraints > Save** to save the placement constraints to the target constraint file, `bft_full.xdc`, in the active constraint set, `constrs_1`.

The synthesis and implementation will go out-of-date since constraints were updated. You can force the design to update by clicking on **Details** in tool bar, since new constraints are already applied.

Timing

Max/Min Delays for Groups - Clocked by wbClk - wbOutputData[0]

Pad	Max Delay	Max Edge	Max Process Corner	Min Delay	Min Edge	Min Process Corner	Edge Skew
wbOutputData[0]	7.911	Rise	SLOW	3.303	Rise	FAST	0.000
wbOutputData[31]	7.984	Rise	SLOW	3.366	Rise	FAST	0.073
wbOutputData[30]	7.961	Rise	SLOW	3.343	Rise	FAST	0.050
wbOutputData[29]	7.969	Rise	SLOW	3.351	Rise	FAST	0.058
wbOutputData[28]	7.970	Rise	SLOW	3.351	Rise	FAST	0.059
wbOutputData[27]	7.978	Rise	SLOW	3.357	Rise	FAST	0.067
wbOutputData[26]	7.951	Rise	SLOW	3.331	Rise	FAST	0.041
wbOutputData[25]	7.958	Rise	SLOW	3.338	Rise	FAST	0.047
wbOutputData[24]	7.959	Rise	SLOW	3.338	Rise	FAST	0.048
wbOutputData[23]	7.965	Rise	SLOW	3.344	Rise	FAST	0.054
wbOutputData[22]	7.951	Rise	SLOW	3.330	Rise	FAST	0.040
wbOutputData[21]	7.955	Rise	SLOW	3.333	Rise	FAST	0.044
wbOutputData[20]	7.986	Rise	SLOW	3.365	Rise	FAST	0.076
wbOutputData[19]	7.994	Rise	SLOW	3.371	Rise	FAST	0.083
wbOutputData[18]	7.942	Rise	SLOW	3.320	Rise	FAST	0.031
wbOutputData[17]	7.945	Rise	SLOW	3.323	Rise	FAST	0.034
wbOutputData[16]	7.981	Rise	SLOW	3.360	Rise	FAST	0.070
wbOutputData[15]	7.987	Rise	SLOW	3.366	Rise	FAST	0.076
wbOutputData[14]	7.949	Rise	SLOW	3.328	Rise	FAST	0.038
wbOutputData[13]	7.942	Rise	SLOW	3.336	Rise	FAST	0.032
wbOutputData[12]	7.891	Rise	SLOW	3.284	Rise	FAST	0.019
wbOutputData[11]	7.897	Rise	SLOW	3.290	Rise	FAST	0.014
wbOutputData[10]	7.905	Rise	SLOW	3.297	Rise	FAST	0.007
wbOutputData[9]	7.914	Rise	SLOW	3.306	Rise	FAST	0.004
wbOutputData[8]	7.886	Rise	SLOW	3.278	Rise	FAST	0.025
wbOutputData[7]	7.881	Rise	SLOW	3.274	Rise	FAST	0.030
wbOutputData[6]	7.915	Rise	SLOW	3.306	Rise	FAST	0.004
wbOutputData[5]	7.919	Rise	SLOW	3.311	Rise	FAST	0.008
wbOutputData[4]	7.868	Rise	SLOW	3.261	Rise	FAST	0.043
wbOutputData[3]	7.874	Rise	SLOW	3.267	Rise	FAST	0.037
wbOutputData[2]	7.875	Rise	SLOW	3.269	Rise	FAST	0.035
wbOutputData[1]	7.878	Rise	SLOW	3.271	Rise	FAST	0.033
wbOutputData[0]	7.911	Rise	SLOW	3.303	Rise	FAST	0.000
Worst Case Summary	7.994	Rise	SLOW	3.261	Rise	FAST	0.083

Bus Skew: 0.083 ns

Datasheet - timing_2

Figure 68: Report Datasheet—Final

Conclusion

In this lab, you did the following:

- Analyzed the clock skew on the output data bus using the Report Datasheet command.
- Used manual placement techniques to improve the timing of selected nets.
- Used the Assign Manual Routing Mode in the Vivado IDE to precisely control the routing of a net.
- Used the `FIXED_ROUTE` property to copy the relative fixed routing among similar nets to control the routing of the critical portion of the nets.

Introduction

In this lab, you will learn how to use the Vivado® Engineering Change Order (ECO) flow to modify your design post implementation, implement the changes, run reports on the changed netlist, and generate programming files.

For this lab, you will use the design file that is included with this guide and is targeted at the Kintex® UltraScale® KCU105 Evaluation Platform. For instructions on locating the design files, see [Locating Design Files for Lab 4](#).

A block diagram of the design is shown in the following figure.

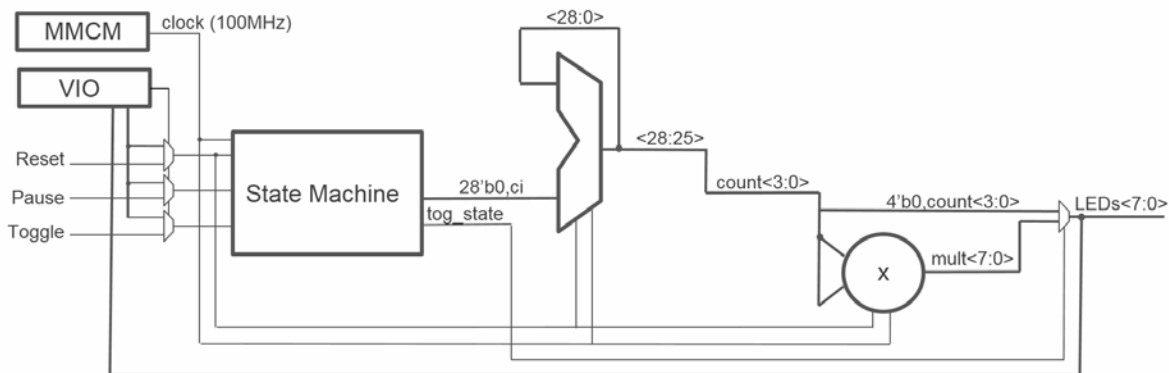

Figure 69: Block Diagram of the Design

In this design, a mixed-mode clock manager (MMCM) is used to synthesize a 100 MHz clock from the 300 MHz clock provided by the board.

A 29-bit counter is used to divide the clock down further. The 4 most significant bits of the counter form the count<3:0> signal that is 0-extended to 8 bits and drives the 8 on-board LEDs through an 8-bit 2-1 mux.

The count<3:0> signal is also squared using a multiplier, and the product drives the other 8 inputs of the mux. A Toggle signal controls the mux select and either drives the LEDs (shown in the following figure) with the counter value or the multiplier output.

A Pause signal allows you to stop the counter, and a Reset signal allows you to reset the design. The Toggle, Pause, and Reset signals can either be controlled from on-board buttons shown in Figure 70 or a VIO in the Hardware Manager as shown in Figure 71. The VIO also allows you to observe the status of the LEDs. The following figures show the location of the push-buttons and the LEDs on the KCU105 board and a Hardware Manager dashboard. These allow you to control the push button and observe the LEDs through the VIO.

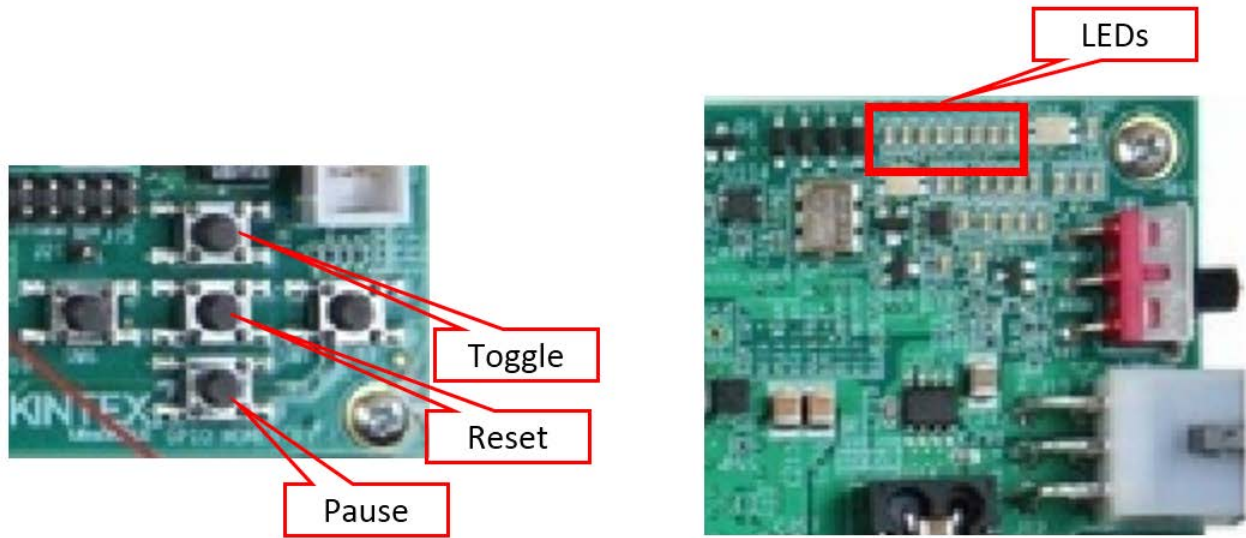

Figure 70: KCU105 On-Board Push Buttons and LEDs

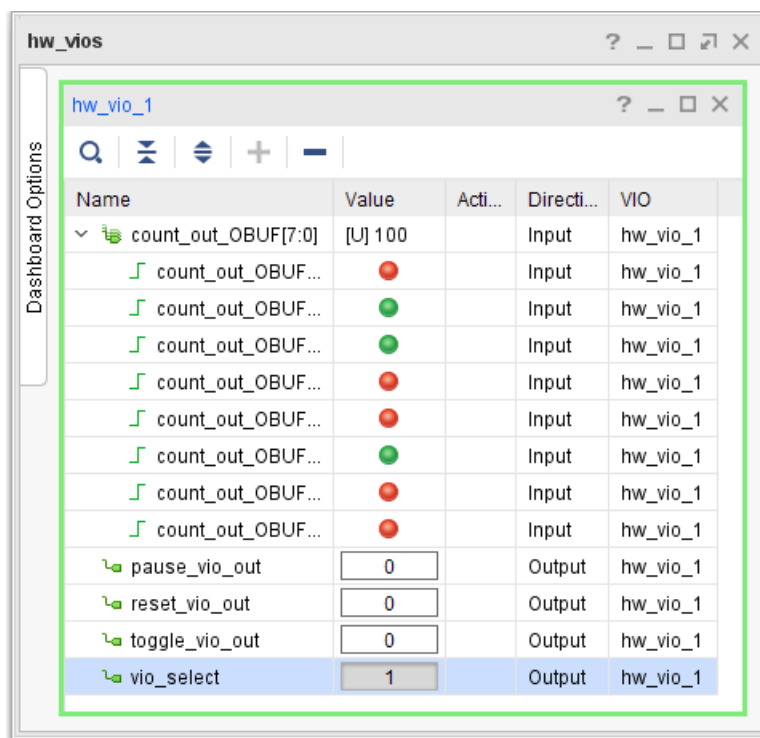



Figure 71: VIO Dashboard

Step 1: Creating a Project Using the Vivado New Project Wizard

To create a project, use the New Project wizard to name the project, to add RTL source files and constraints, and to specify the target device.

1. Open the Vivado Design Suite integrated development environment (IDE).
2. In the Getting Started page, click **Create Project** to open the New Project wizard.
3. Click **Next**.
4. In the Project Name page, do the following:
 - a. Name the new project `project_ECO_lab`.
 - b. Provide the project location `C:/Vivado_Tutorial`.
 - c. Ensure that Create project subdirectory is selected.
 - d. Click **Next**.
5. In the Project Type page, do the following:
 - a. Specify the **Type of Project** to create as **RTL Project**.
 - b. Leave the **Do not specify sources at this time** check box unchecked.
 - c. Click **Next**.
6. In the Add Sources page, do the following:
 - a. Set the Target Language to Verilog.
 - b. Click **Add Files**.
 - c. In the Add Source Files dialog box, navigate to the `/src/lab4` directory.
 - d. Select all Verilog source files.
 - e. Click **OK**.
 - f. Verify that the files are added.
 - g. Click **Add Files**.
 - h. In the Add Source Files dialog box, navigate to the `/src/lab4/IP` directory.
 - i. Select all of the XCI source files and click **OK**.
 - j. Verify that the files are added and **Copy sources into project** is selected.
 - k. Click **Next**.
7. In the Add Constraints dialog box, do the following:
 - a. Click the **Add** button , and then select **Add Files**.

- b. Navigate to the `/src/lab4` directory and select `ECO_kcu105.xdc`.
- c. Click **Next**.
8. In the Default Part page, do the following:
 - a. Select **Boards** and then select **Kintex-UltraScale KCU105 Evaluation Platform**.
 - b. Click **Next**.
9. Review the New Project Summary page. Verify that the data appears as expected, per the steps above.
10. Click **Finish**.

Note: *It might take a moment for the project to initialize.*

11. In the Sources window in the Vivado IDE, expand `top` to see the source files for this lab.

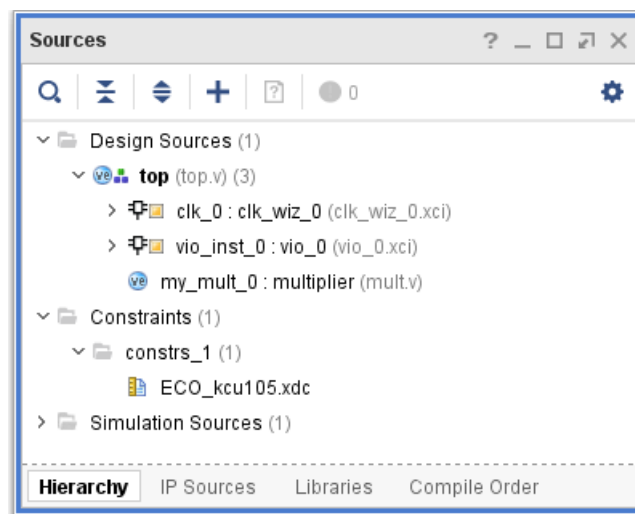

Figure 72: Sources Window

Step 2: Synthesizing, Implementing, and Generating the Bitstream

1. In the Flow Navigator, under **Program and Debug**, click **Generate Bitstream**.

This synthesizes, implements, and generates a bitstream for the design.

The **No Implementation Results Available** dialog box appears.

2. Click **Yes**.

After bitstream generation completes, the **Bitstream Generation Completed** dialog box appears. **Open Implemented Design** is selected by default.

3. Click **OK**.

4. Inspect the Timing Summary report and make sure that all timing constraints have been met.

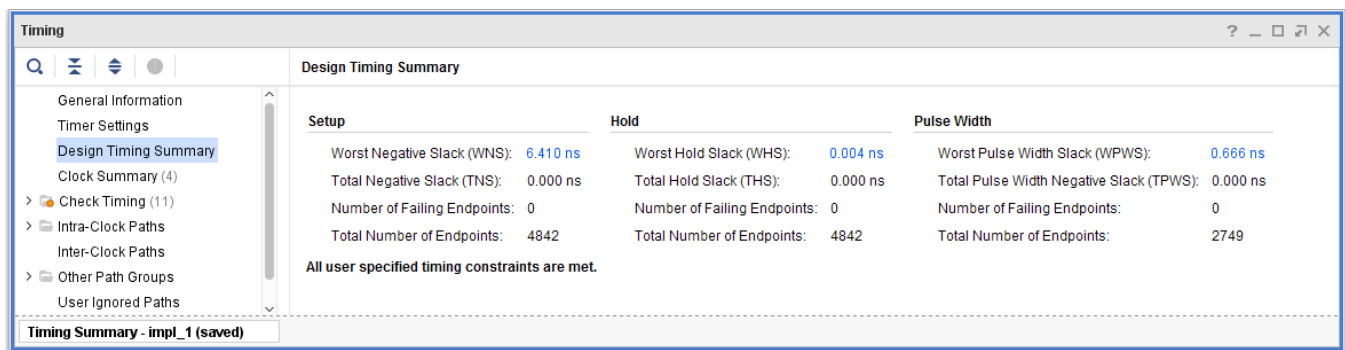

Design Timing Summary			
Setup	Hold	Pulse Width	
Worst Negative Slack (WNS): 6.410 ns	Worst Hold Slack (WHS): 0.004 ns	Worst Pulse Width Slack (WPWS): 0.666 ns	
Total Negative Slack (TNS): 0.000 ns	Total Hold Slack (THS): 0.000 ns	Total Pulse Width Negative Slack (TPWS): 0.000 ns	
Number of Failing Endpoints: 0	Number of Failing Endpoints: 0	Number of Failing Endpoints: 0	
Total Number of Endpoints: 4842	Total Number of Endpoints: 4842	Total Number of Endpoints: 2749	
All user specified timing constraints are met.			

Figure 73: Timing Summary Report

You can use the generated bitstream programming file to download your design into the target FPGA device using the Hardware Manager. For more information, see the *Vivado Design Suite User Guide: Programming and Debugging* ([UG908](#)).

Step 3: Validating the Design on the Board

This step is optional, but will help you understand the ECO modifications that you will make in [Step 4: Making the ECO Modifications](#).

1. From the main menu, select **Flow > Open Hardware Manager**.

The Hardware Manager window opens.

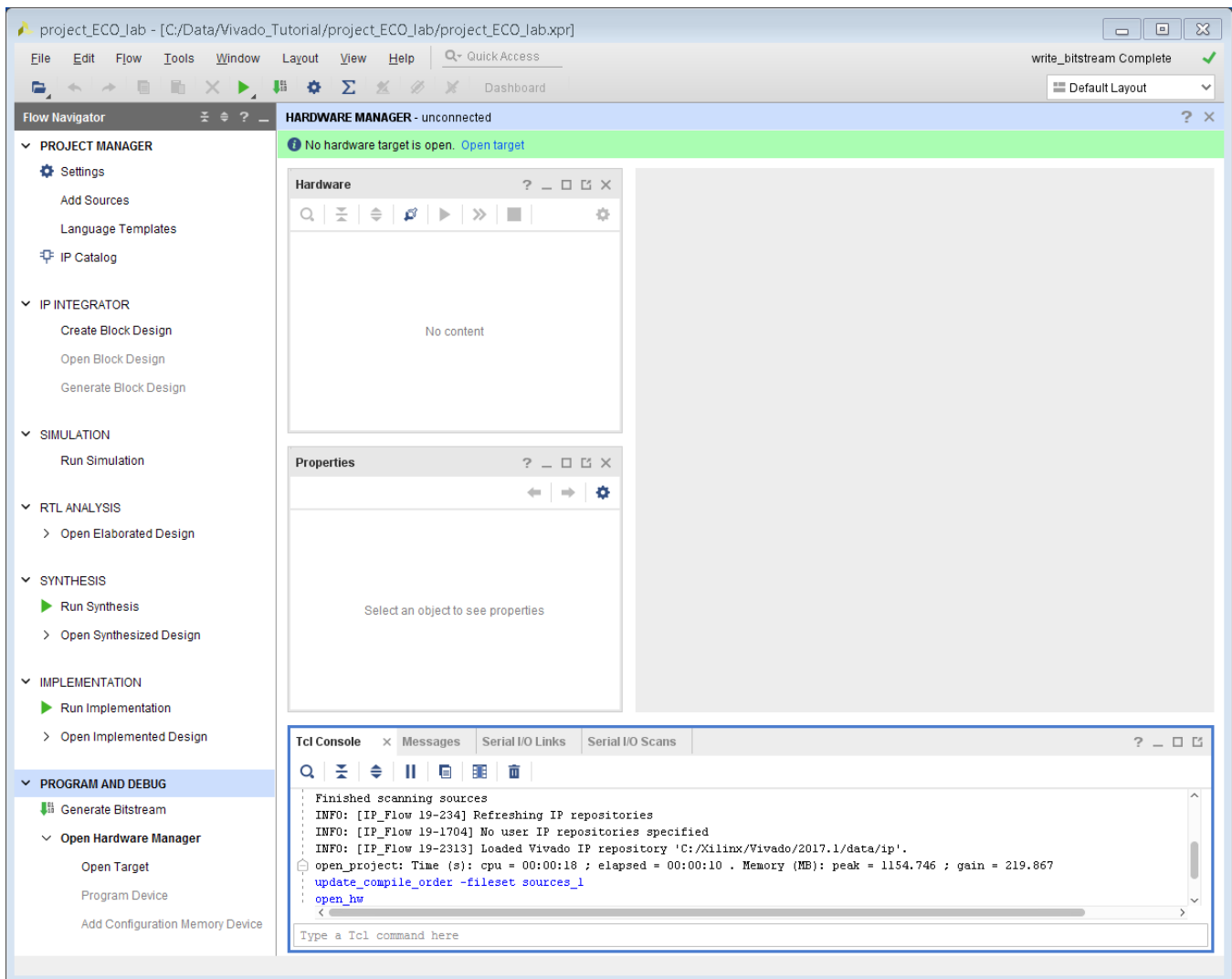

Figure 74: Hardware Manager Window

2. Connect to a hardware target Using `hw_server`.



TIP: For more information about different ways to connect to a hardware target, refer to the **Vivado Design Suite User Guide: Programming and Debugging (UG908)**.

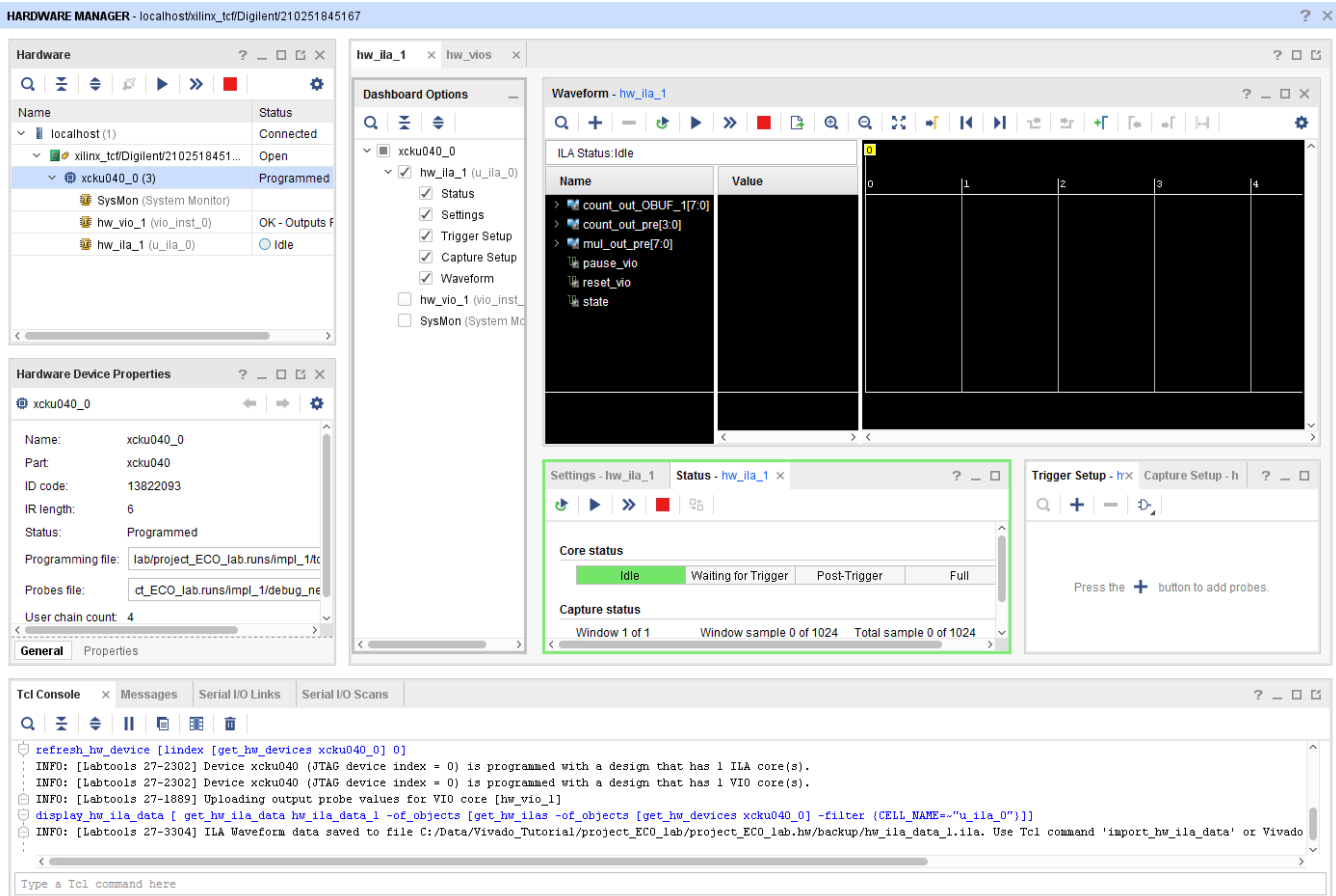

Figure 75: Use hw_server to Connect to a Hardware Target

3. In the Vivado Flow Navigator, under **Program and Debug**, click **Program Device**.

The Program Device dialog box opens.

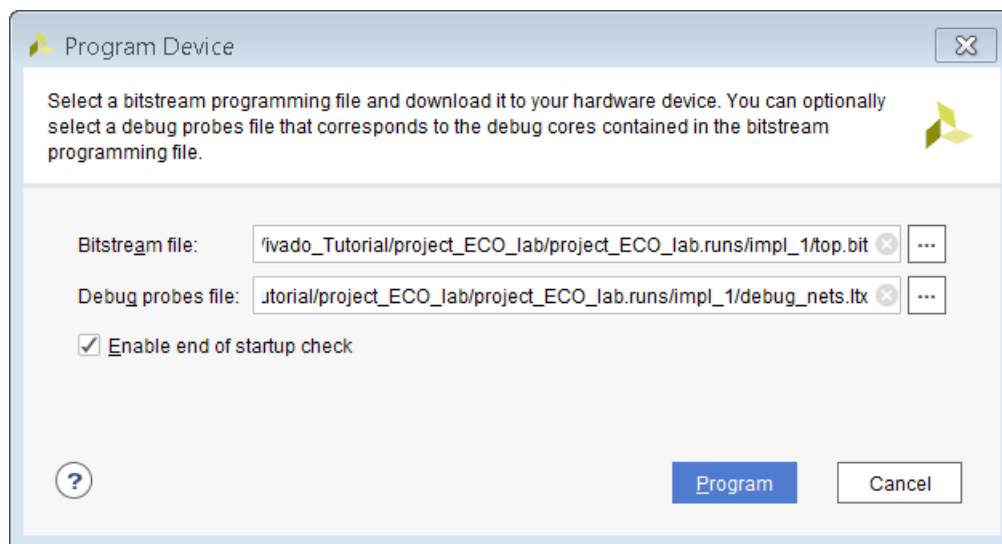

Figure 76: Program Device Dialog Box

4. Navigate to the Bitstream file and Debug Probes file.
5. Click **Program**.

Now that the FPGA is configured, you can use the on-board buttons and the on-board LEDs to control and observe the hardware. Press the **Pause** button to pause the counter. Press the **Toggle** button to select between the count and the multiplier result. Press the **Reset** button to reset the counter.

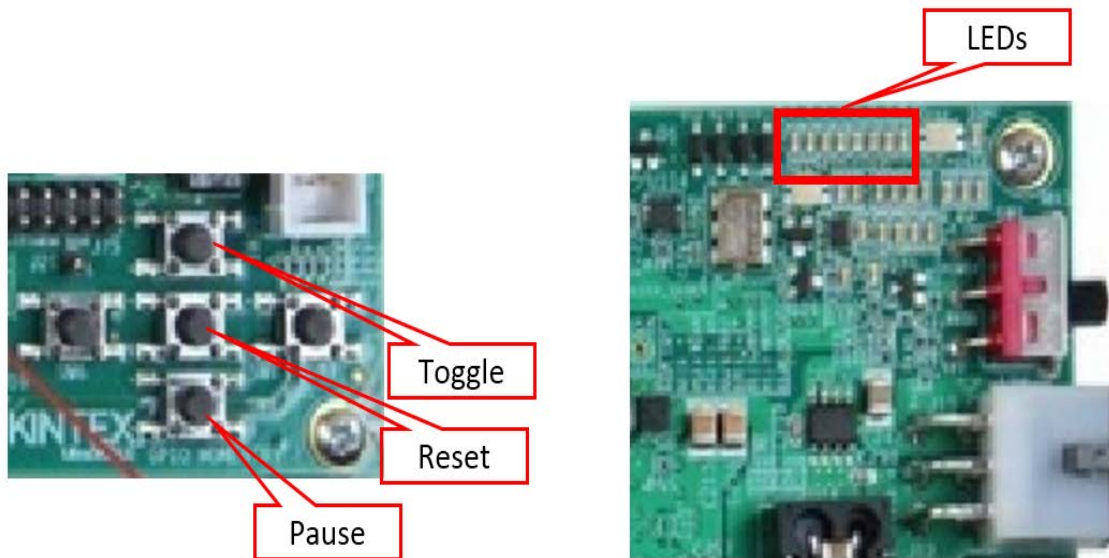

Figure 77: On-Board Push Buttons and LEDs

Alternatively, you can use the VIO to control and observe the hardware.

If the following warning message appears, select one of the alternatives suggested in the message.

```
WARNING: [Labtools 27-1952] VIO hw_probe OUTPUT_VALUE properties for hw_vio(s)
[hw_vio_1] differ from output values in the VIO core(s).
```

Resolution:

To synchronize the hw_probes properties and the VIO core outputs choose one of the following alternatives:

- 1) Execute the command 'Commit Output Values to VIO Core', to write down the hw_probe values to the core.
- 2) Execute the command 'Refresh Input and Output Values from VIO Core', to update the hw_probe properties with the core values.
- 3) First restore initial values in the core with the command 'Reset VIO Core Outputs', and then execute the command 'Refresh Input and Output Values from VIO Core'.

6. Select the **hw_vios** tab in the dashboard and click the **Add** button  to add probes.
The Add Probes dialog box opens.

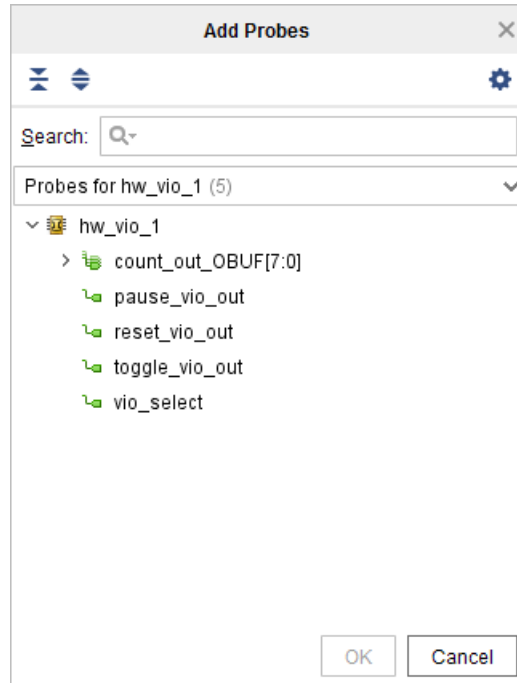

Figure 78: Add Probes Dialog Box

7. Select all of the probes for `hw_vio_1` and click **OK**.
8. In the `hw_vios` dashboard, select `count_out_OBUF[7:0]`, then right-click and select **Radix Unsigned Decimal**.

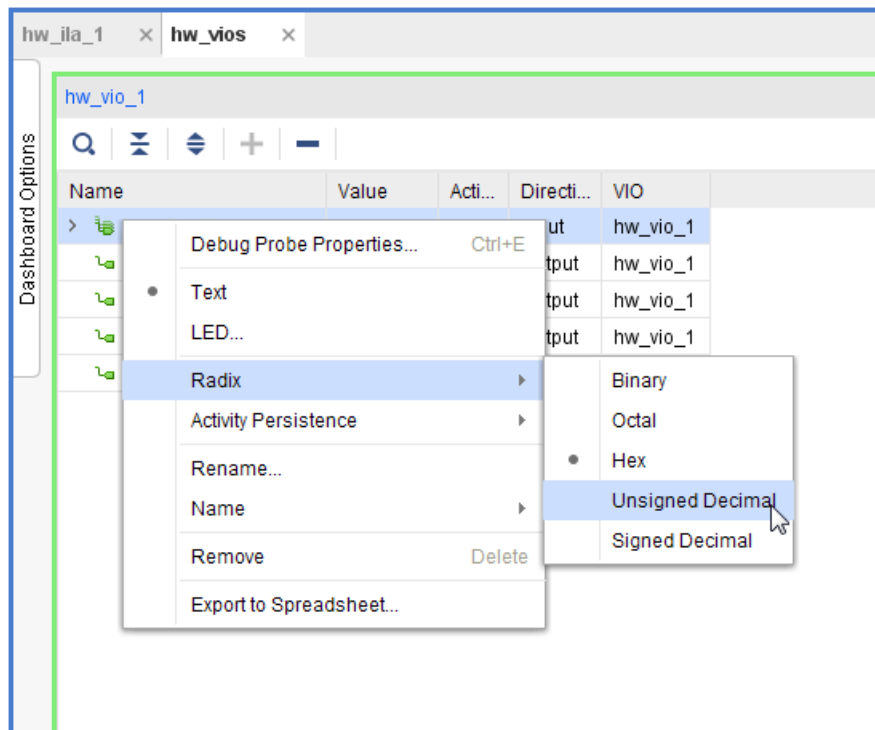

Figure 79: Selecting Radix > Unsigned Decimal

9. In the hw_vios dashboard, select `count_out_OBUF[7:0]`, then right-click and select **LED**.
The Select LED Colors dialog box opens.

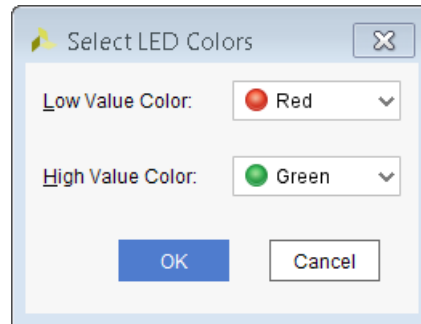

Figure 80: Select LED Colors Dialog Box

10. Select **Red** for the Low Value Color and **Green** for the High Value Color.
11. Click **OK**.

12. In the hw_vios dashboard, select `pause_vio_out`, `reset_vio_out`, and `toggle_vio_out`, then right-click and select **Active-High Button**.

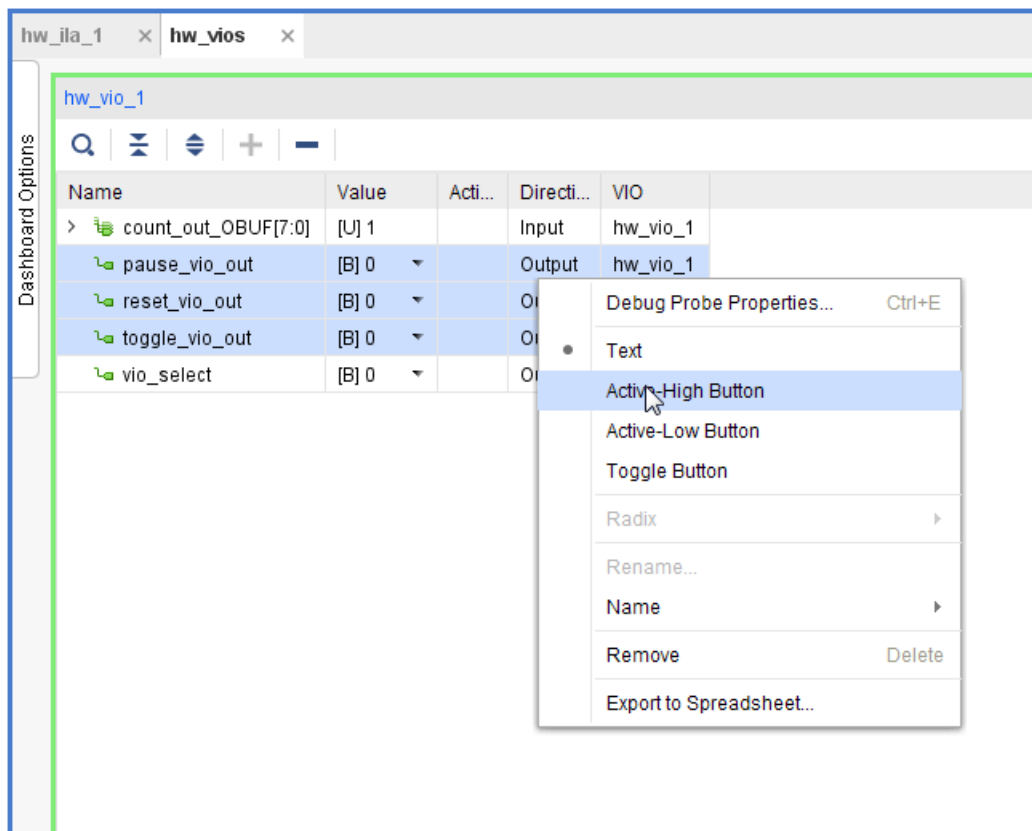

Figure 81: Selecting Active-High Button

13. In the hw_vios dashboard, select `vio_select` and select **Toggle Button**.

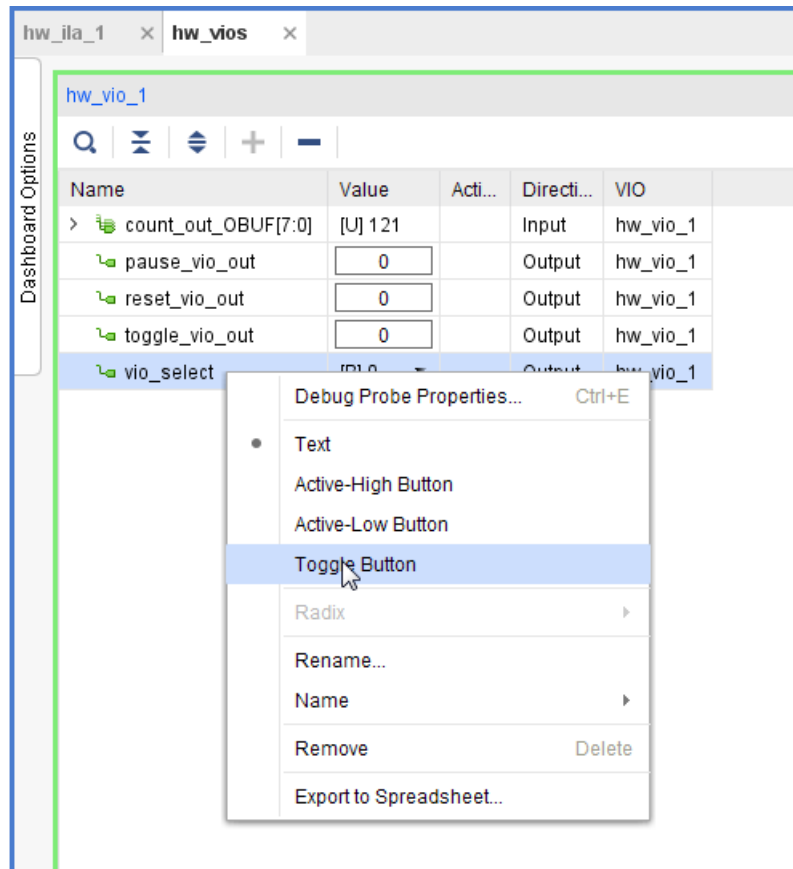

Figure 82: Selecting Toggle Button

14. Expand `count_out_OBUF[7:0]` to view the VIO LEDs.

Now that the VIO is set up, you are ready to analyze the design.

15. Toggle the **vio_select** button to control the hardware from the VIO.

16. Press the **pause_vio_out** button to pause the counter.

17. Press the **toggle_vio_out** button to select between the count and the multiplier result.

18. Press the **reset_vio_out** button to reset the counter.

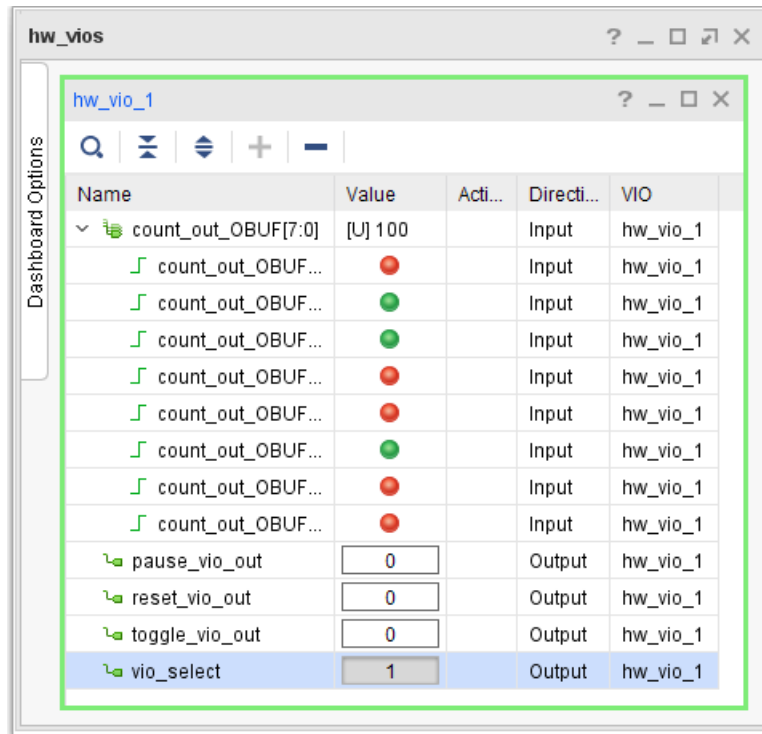

Figure 83: hw_vios Toggle Button Window

Step 4: Making the ECO Modifications

1. In the Flow Navigator, select the **Project Manager**.
2. In the Design Runs window, right-click on **impl_1** and select **Open Run Directory**.
3. The run directory opens in a file browser, as seen in the following figure. The run directory contains the routed checkpoint (`top_routed.dcp`) to be used for the ECO flow.



TIP: *In a project-based design, the Vivado Design Suite saves intermediate implementation results as design checkpoints in the implementation runs directory. When you re-run implementation, the previous results are deleted. Save the router checkpoint to a new directory to preserve the modified checkpoint.*

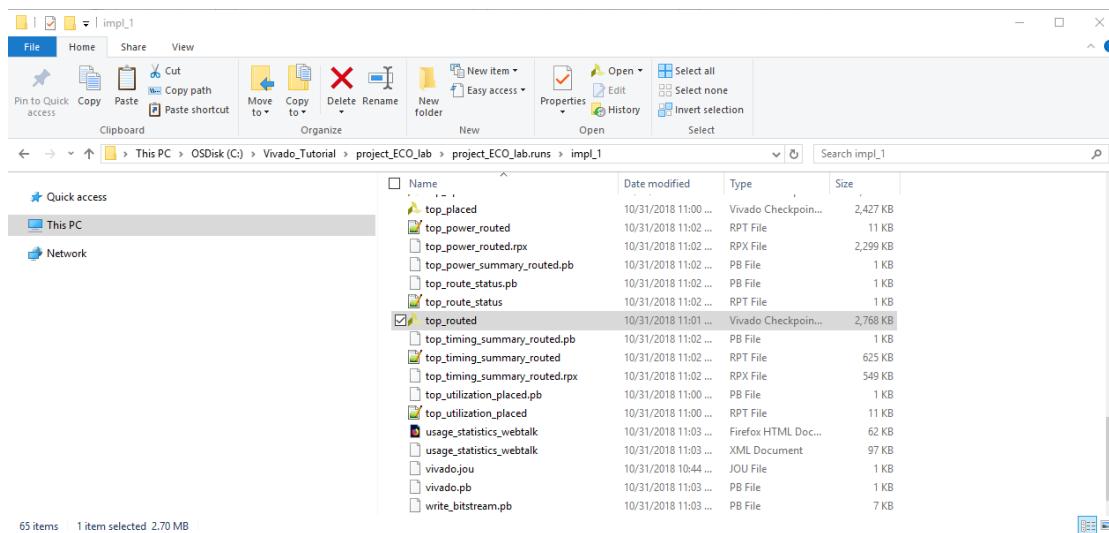

Figure 84: Implementation Run Directory

4. Create a new directory named **ECO** in the original `C:/Vivado_Tutorial/project_ECO_lab` project directory, and copy the `top_routed.dcp` file from the implementation runs directory to that newly created directory.
5. From the main menu, select **File > Checkpoint > Open**.
The Open Checkpoint dialog box opens.
6. Navigate to `C:/Vivado_Tutorial/project_ECO_lab/ECO` and select the `top_routed.dcp` checkpoint.
A dialog box opens, asking whether to close the current project.
7. Click **Yes**.
8. From the main menu, select **Layout > ECO**.

The ECO Layout is selected. The ECO Navigator is displayed on the left of the layout (highlighted in red in the following figure). It provides access to netlist commands, run steps, report and analysis tools, and commands to save changes and generate programming files.

The Scratch Pad in the center of the layout (highlighted in red in the following figure) tracks netlist changes, as well as place and route status for cells, pins, ports, and nets.

Note: ECOs only work on design checkpoints. The ECO layout is only available after you have opened a design checkpoint in the Vivado IDE.

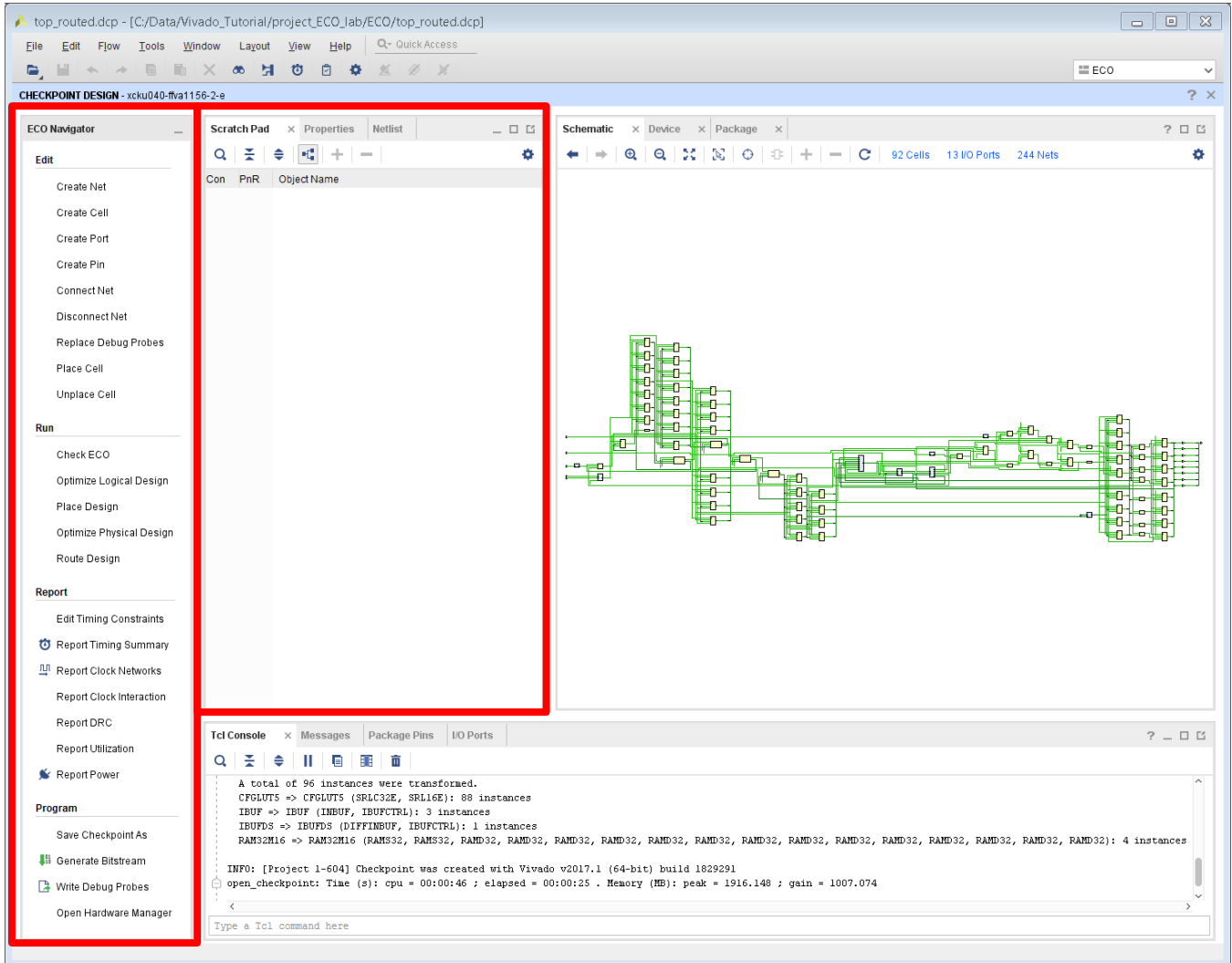

Figure 85: ECO Layout

To illustrate the capabilities of the ECO flow, you next change the functionality of the multiplier from a square of `count [3 : 0]` to a multiply by two.

9. From the Tcl Console, type the following command:

```
mark_objects -color blue [get_cells my_mult_0]
```



TIP: To make it easier to locate objects that are included in the ECO modifications, it helps to mark or highlight the objects with different colors.

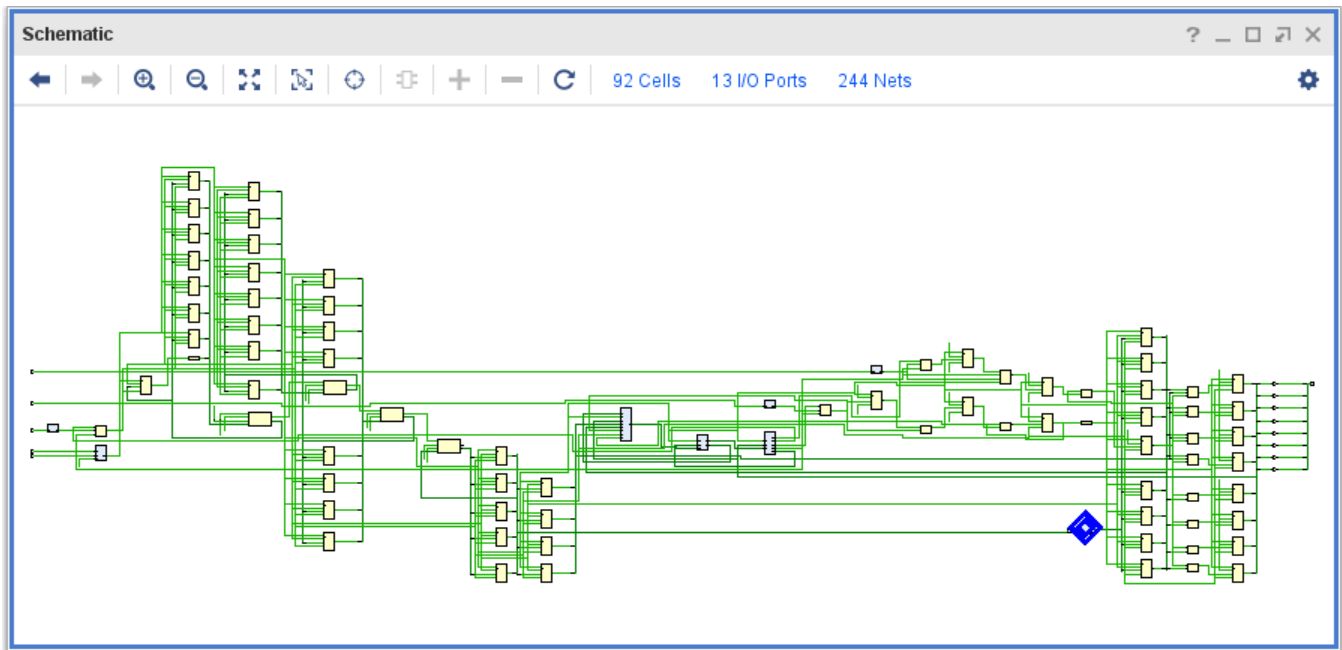

Figure 86: Schematic with Multiplier Marked

10. Zoom into the multiplier in the schematic window and select the `in2[3:0]` pins.

Alternatively, you can type the following command in the Tcl Console:

```
select_objects [get_pins my_mult_0/in2[*]]
```

11. Click the **Disconnect Net** button in the **Edit** section of the Vivado ECO Navigator. The net is disconnected from the pins in the schematic.

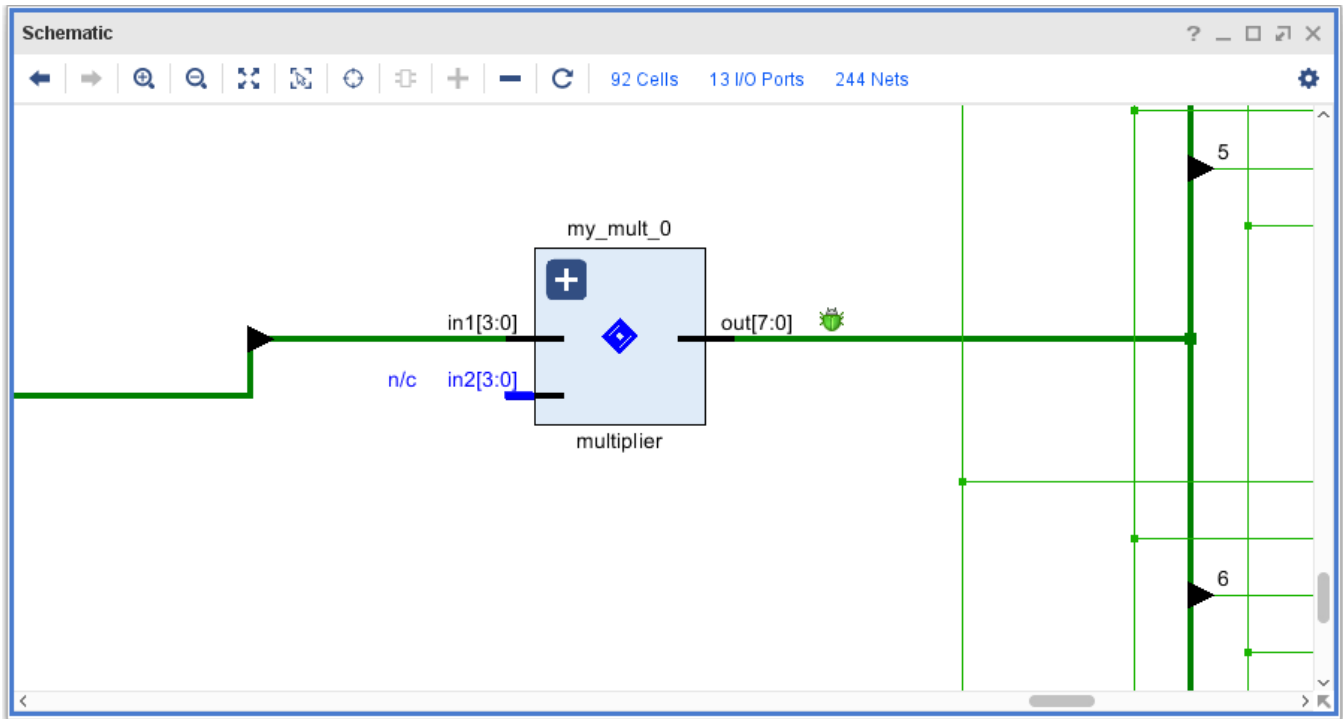

Figure 87: Schematic with Net Disconnected from Pins in2[3:0]

The Tcl Console reproduces the `disconnect_net` command that you just executed in the ECO Navigator. This is useful if you want to replay your ECO changes later by opening the original checkpoint and sourcing a Tcl script with the ECO commands.

```
mark_objects -color blue [get_cells my_mult_0]
startgroup
disconnect_net -objects [list {my_mult_0/in2[3]}]
disconnect_net -objects [list {my_mult_0/in2[2]}]
disconnect_net -objects [list {my_mult_0/in2[1]}]
disconnect_net -objects [list {my_mult_0/in2[0]}]
endgroup
|
Type a Tcl command here
```

Figure 88: Tcl Console Showing Executed ECO Commands

The Scratch Pad is populated with the 4 nets `divClk_reg[28:25]` that you disconnected and the multiplier input pins `my_mult_0/in2[3:0]`. Note the following in the Scratch Pad:

- The Scratch Pad connectivity column (Con) shows a check mark next to the `divClk_reg[28:25]` nets, indicating that they are still connected to the other multiplier inputs.
- The `my_mult_0/in2[3:0]` pins do not show a check mark next to them because they no longer have nets connected.
- The Place and Route (PnR) column is unchecked for everything, indicating that the changes have not yet been implemented on the device.

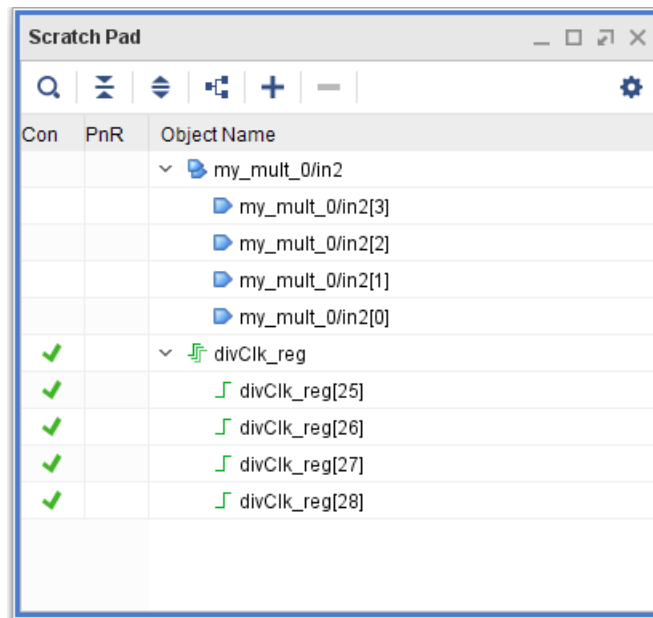

Figure 89: Scratch Pad Showing Status of ECO

12. In the Scratch Pad, select the `{my_mult_0/in2[3], my_mult_0/in2[2], and my_mult_0/in2[0]}` pins.

13. In the **Edit** section of the Vivado ECO Navigator, click **Connect Net**.

The Connect Net dialog box opens.

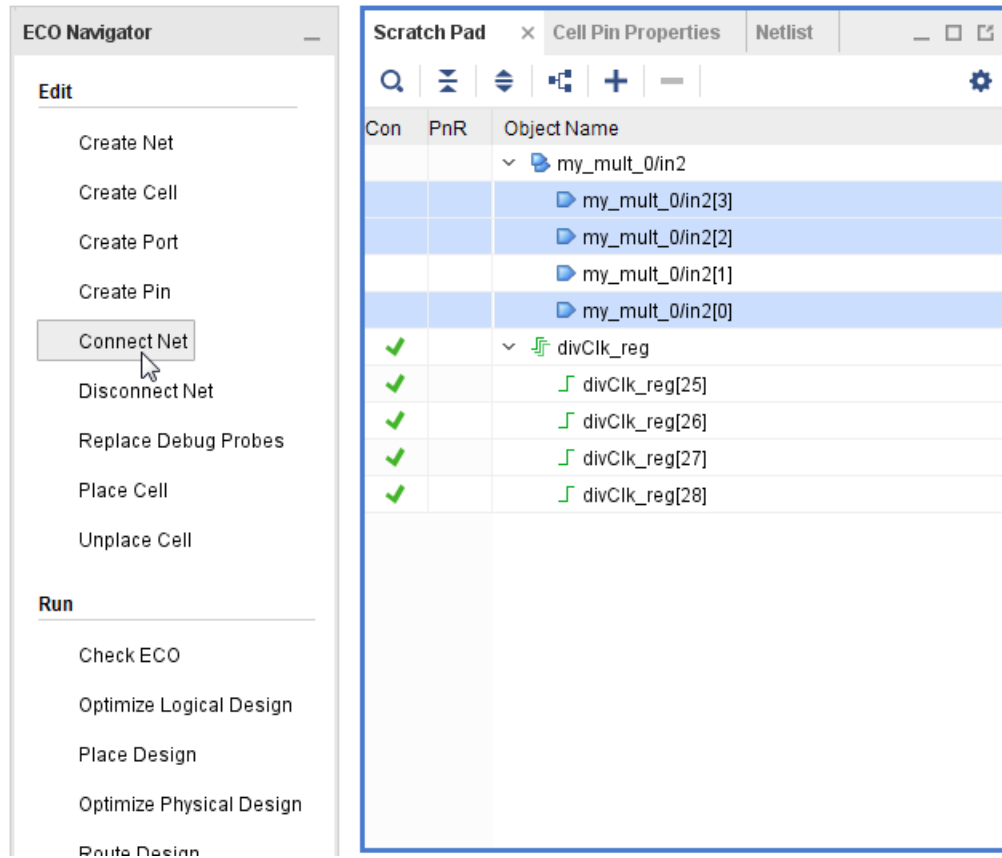

Figure 90: Connect Selected Pins

14. In the Connect Net dialog box, select <const 0> from the GROUND section.

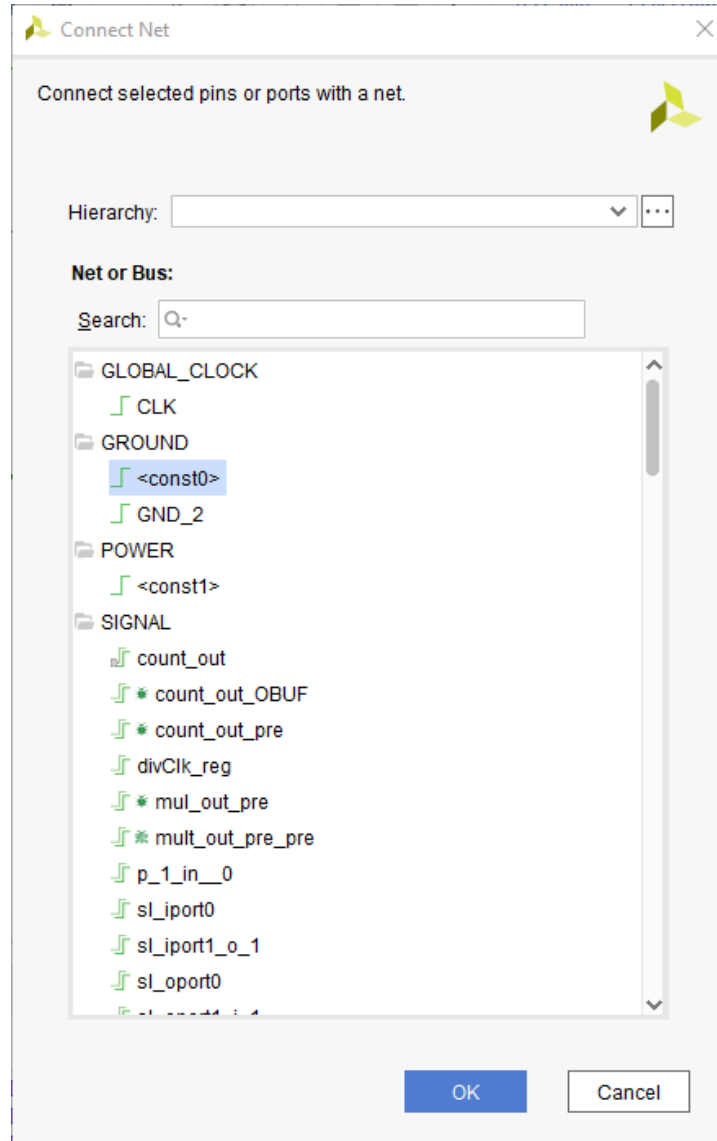

Figure 91: Connect Net Dialog Box

15. Click **OK**.

<const0> is added to the Scratch Pad.

16. Collapse the <const0> signal.

The three pins that you connected now show check marks in the Connectivity column of the Scratch Pad.

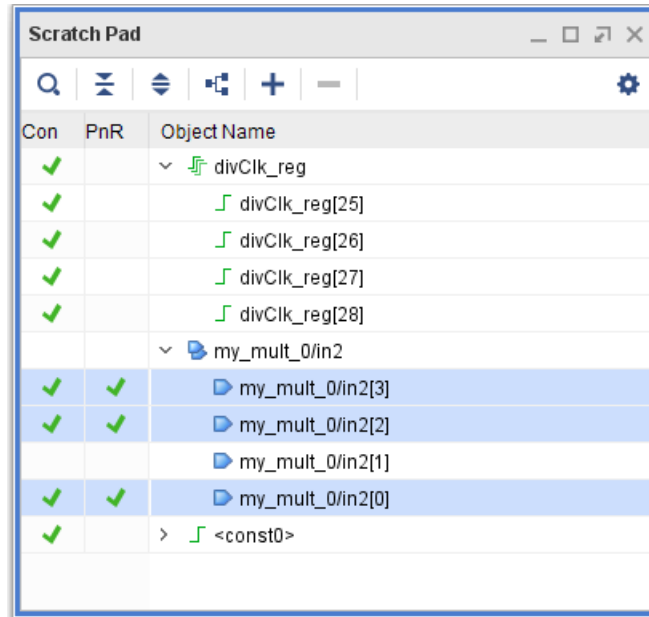

Figure 92: Scratch Pad Showing <const0> Connected to Pins

17. In the Scratch Pad, select the my_mult_0/in2[1] pin.

18. Click **Connect Net**.

The Connect Net dialog box opens.

19. In the Connect Net dialog box, select `<const1>` from the POWER section.

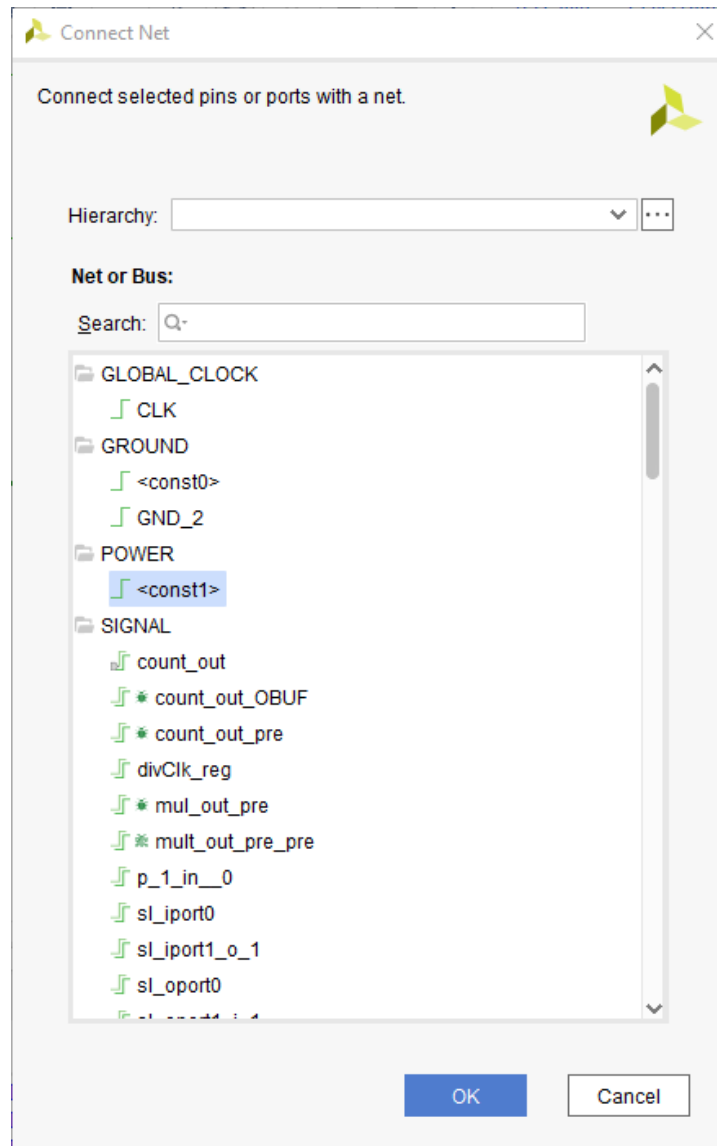

Figure 93: Connect Net Dialog Box

20. Click **OK**.

`<const1>` is added to the Scratch Pad.

21. Collapse the `<const1>` signal.

The pin that you connected now shows check marks in the Connectivity column of the Scratch Pad.

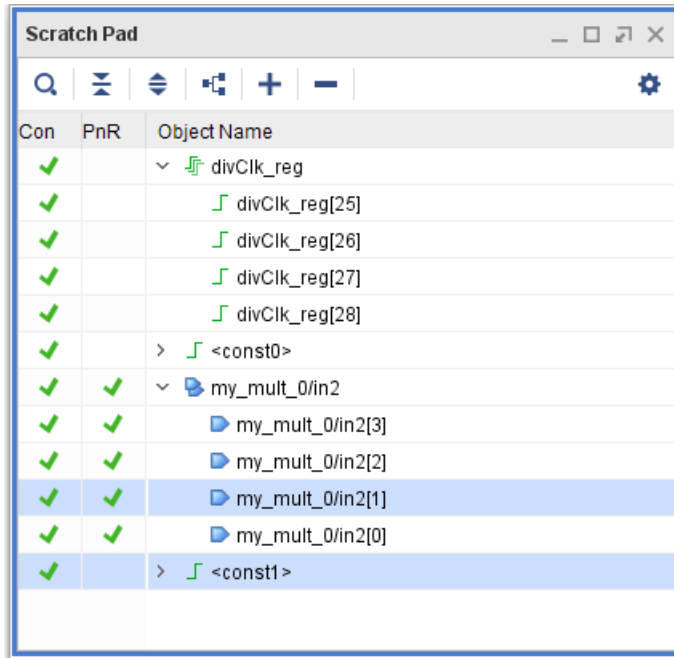

Figure 94: Scratch Pad Showing <const1> Connected to Pin

22. Select the `my_mult_0/in2` pin in the Scratch Pad.

This command highlights the pins in the currently open Schematic view window, and shows the updated connections.

Note: Make sure that the **Autofit Selection** toggle button is highlighted in the Schematic window so you can see the entire path, as shown in the following figure.

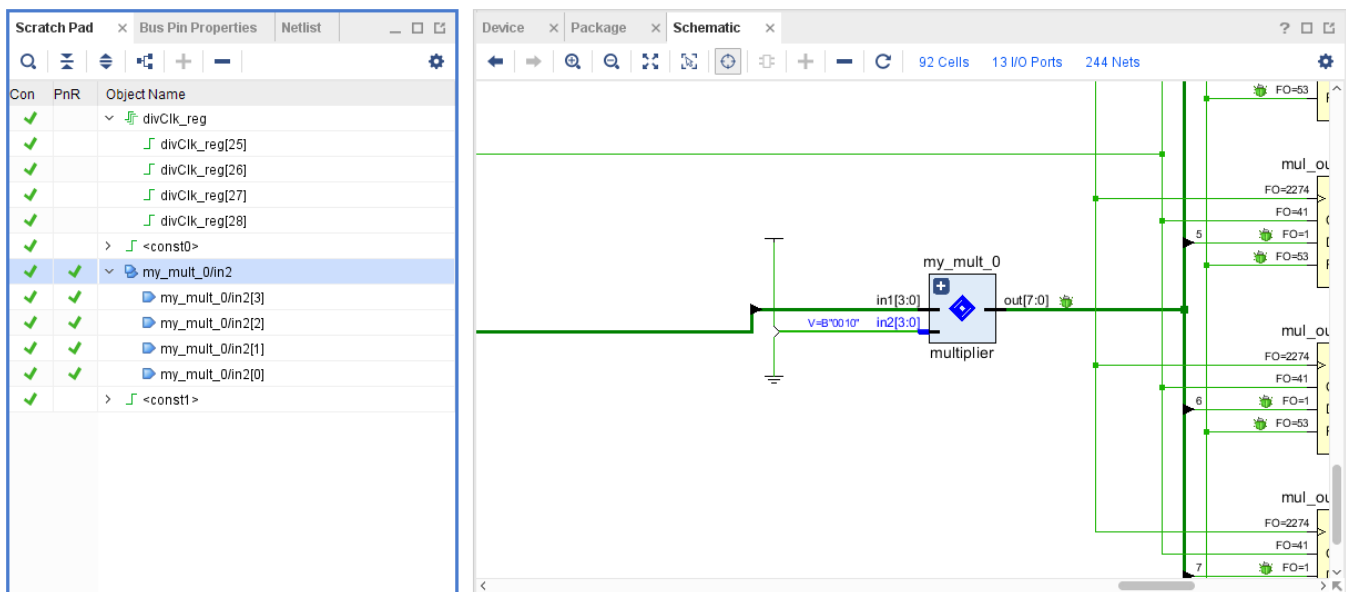

Figure 95: Resulting Schematic After Applying ECO Flow

When you observe the count signal on the LEDs, you only use 4 bits. The upper 4 bits are padded with zeroes.

Now, you will use the ECO flow to observe counter bit 24 on LED 7. The first step is to analyze the logic that drives `count_out_reg[3]`.

23. From the Tcl Console, type the following command:

```
select_objects [get_cells count_out[3]_i_1]
```

This lets you quickly identify the LUT3 that drives the `count_out_reg[3]` register, which drives LED 3. The inputs are:

- o `mul_out_pre_reg[3]` for pin I0
- o `count_out_pre_reg[3]` for pin I1
- o `tog_state_reg` for pin I2

24. Click the **Cell Properties** tab to view the cell properties and select the **Truth Table** tab.

25. Click **Edit LUT Equation** to view the equation for the LUT3. Note the LUT equation:

$$O = I1 \& !I2 + I0 \& I2$$

26. Click **Cancel** to close the window.

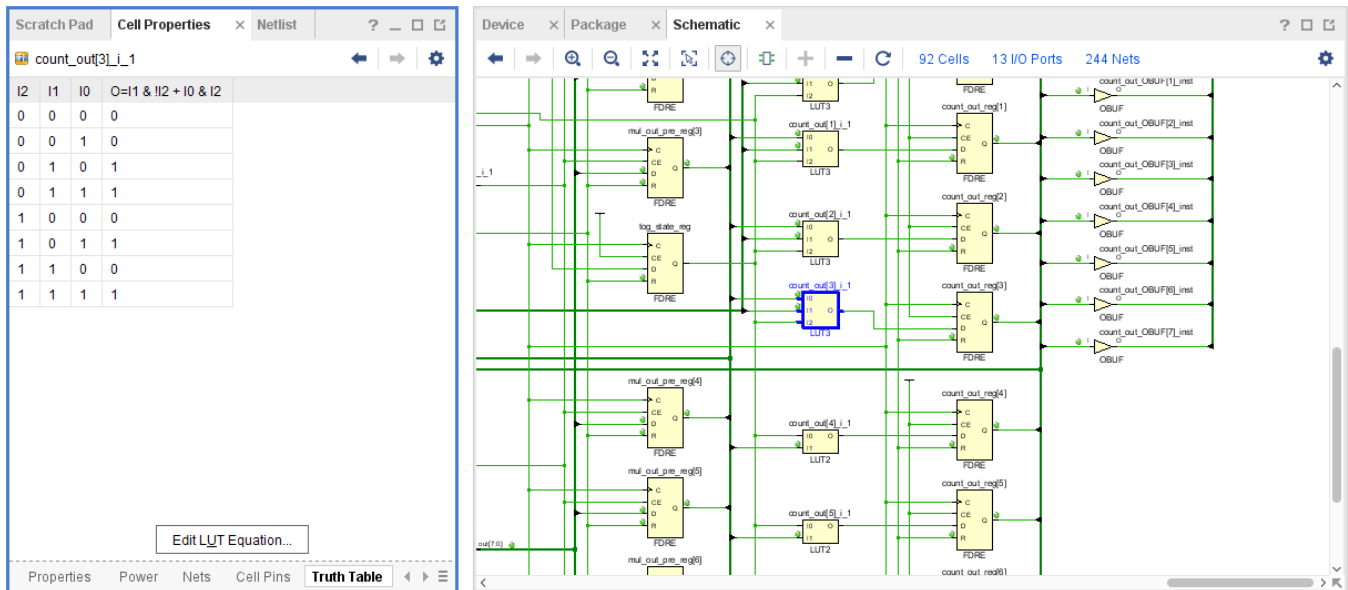

Figure 96: LUT3 Driving count_out_reg[3]

27. From the Tcl Console, type the following command:

```
select_objects [get_cells count_out[7]_i_1]
```

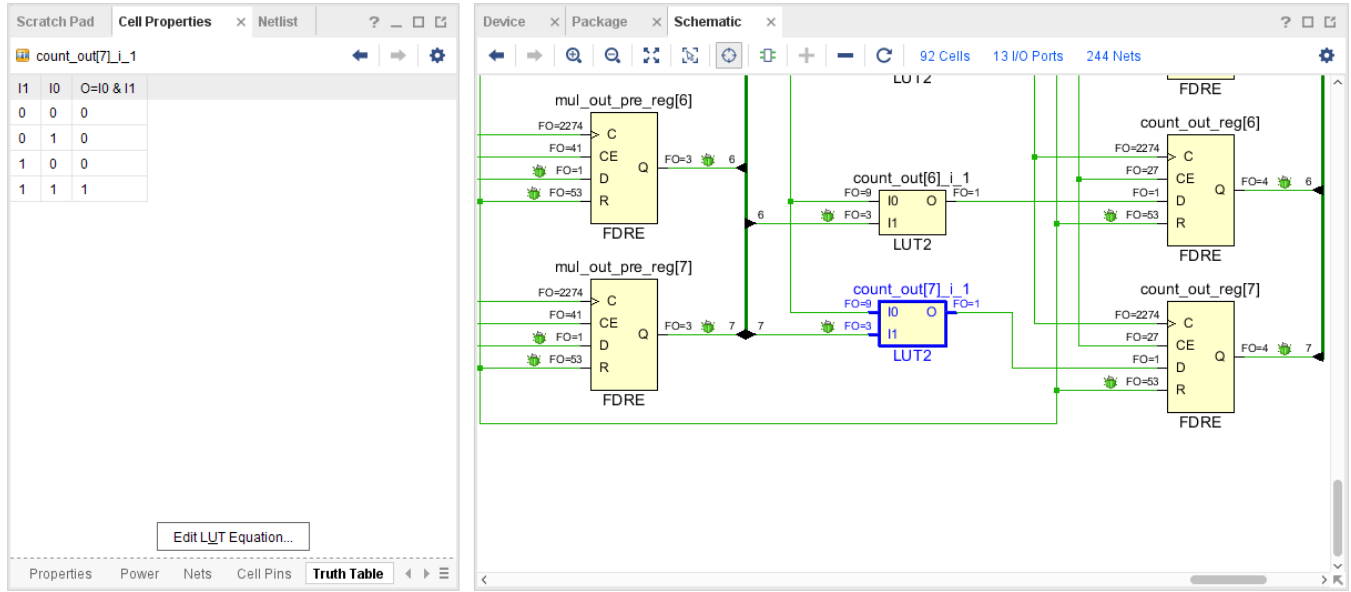

Figure 97: LUT2 Driving count_out_reg[7]

This command selects the LUT2 that drives the `count_out_reg[7]` register, which drives LED 7 on the KCU105 board. The only inputs are `tog_state_reg` for pin I0 and `mul_out_pre_reg[7]` for pin I1. You need to replace the LUT2 with a 3-input LUT and connect the output of counter register `divClk_reg[24]` to the additional input pin.

28. In the Vivado ECO Navigator, under **Edit**, click **Create Cell**.

The Create Cell dialog box opens.

- a. In the **Cell name** field, enter `ECO_LUT3`.
- b. In the **Search** field, enter `LUT3`.
- c. Select LUT3 as the cell type and copy the LUT equation `O=I1 & !I2 + I0 & I2` from cell `count_out[3]_i_1`.
- d. Click **OK**.

`ECO_LUT3` is added to the Scratch Pad and the schematic.

- e. Right-click the newly added `ECO_LUT3` cell in the Scratch Pad, then select **Mark** and the color red.

Note: Marking the `ECO_LUT3` cell makes it easier to locate.

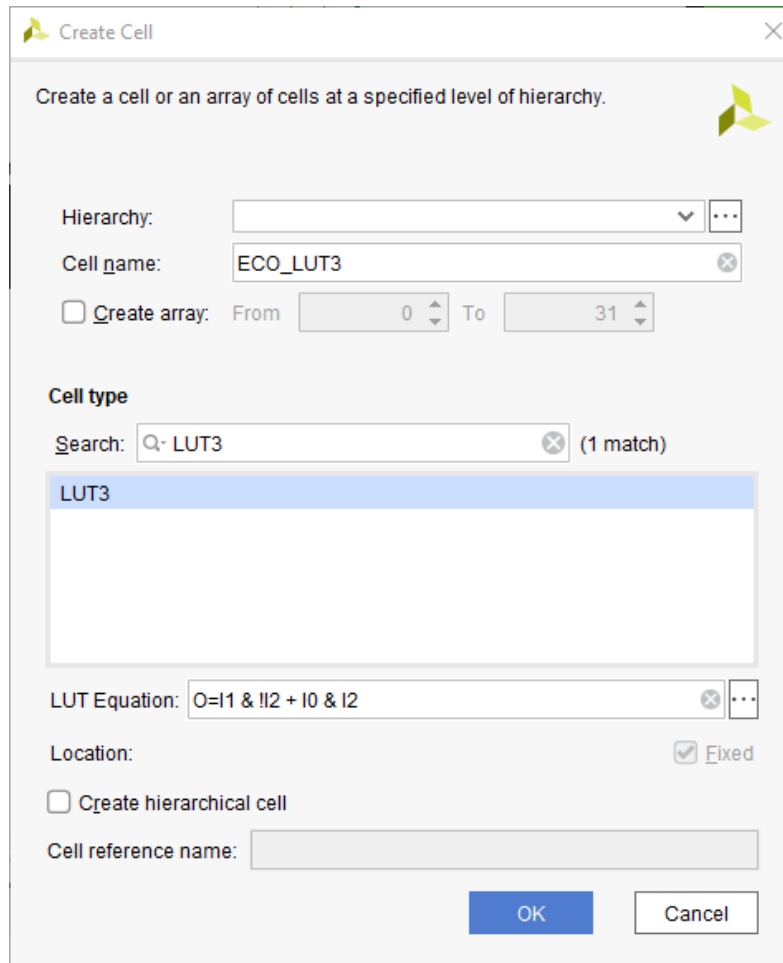

Figure 98: Create Cell Dialog Box

Because you copied the LUT equation from cell `count_out[3]_i_1`, the nets must be hooked up in the same order, with the following connections:

- Net `mul_out_pre[7]` connected to pin `I0`
- Net `divClk_reg_n_0_[24]` connected to pin `I1`
- Net `tog_state` connected to pin `I2` of `ECO_LUT3`

29. Locate the `tog_state` net driven by the `tog_state_reg` register in the schematic and select it. Alternatively you can select the net from the Tcl Console by running the following command:

```
select_objects [get_nets tog_state]
```

30. Connect the I2 pin of the newly added ECO_LUT3 cell by doing the following:

- a. Hold down the **CTRL** key and select pin I2 in the Scratch Pad. This selects pin I2 in addition to the already selected `tog_state` net.
- b. Click **Connect Net**.

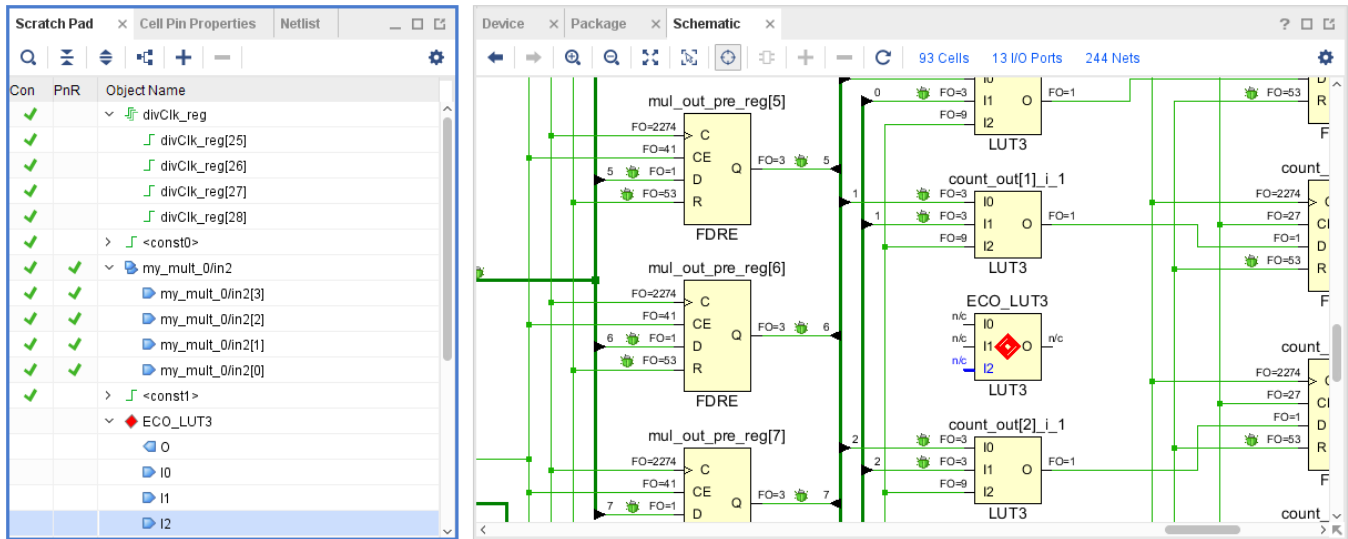

Figure 99: Scratch Pad and Schematic Showing ECO_LUT3 Added

31. Locate the `mul_out_pre[7]` net in the schematic and select it.

Alternatively, you can select the net from the Tcl Console by executing the following command:

```
select_objects [get_nets mul_out_pre[7]]
```

32. Connect the I0 pin of the newly added ECO_LUT3 cell by doing the following:

- a. Hold down the **CTRL** key and select pin I0 in the Scratch Pad. This selects pin I0 in addition to the already selected `mul_out_pre[7]` net.
- b. Click **Connect Net**.

33. Locate the `divClk_reg_n_0[24]` net in the schematic and select it.

Alternatively, you can select the net from the Tcl Console by executing the following command:

```
select_objects [get_nets divClk_reg_n_0[24]]
```

34. Connect the I1 pin of the newly added ECO_LUT3 cell by doing the following:

- a. Hold down the **CTRL** key and select pin I1 from the Scratch Pad. This selects pin I1 in addition to the already selected `divClk_reg_n_0[24]` net.
- b. Click **Connect Net**.

Next, you need to connect the updated logic function implemented in the newly created LUT3 to the D input of `count_out_reg[7]`. The first step is to delete the LUT2 that was previously connected to the D input.

35. Select the LUT2 `count_out[7]_i_1` in the schematic window.

Alternately, you can select it by executing the following command in the Tcl Console:

```
select_objects [get_cell count_out[7]_i_1]
```

36. In the main toolbar, click the **Delete** button to delete the selected cell.

37. Select the net connected to the D input of the `count_out_reg[7]` register in the schematic window.

Alternately you can select the net from the Tcl Console by executing the following command:

```
select_objects [get_nets count_out[7]_i_1_n_0]
```

38. Connect the O pin of the newly added `ECO_LUT3` cell by doing the following:

- Hold down the **CTRL** key and select pin O from the Scratch Pad.
- Click **Connect Net**.

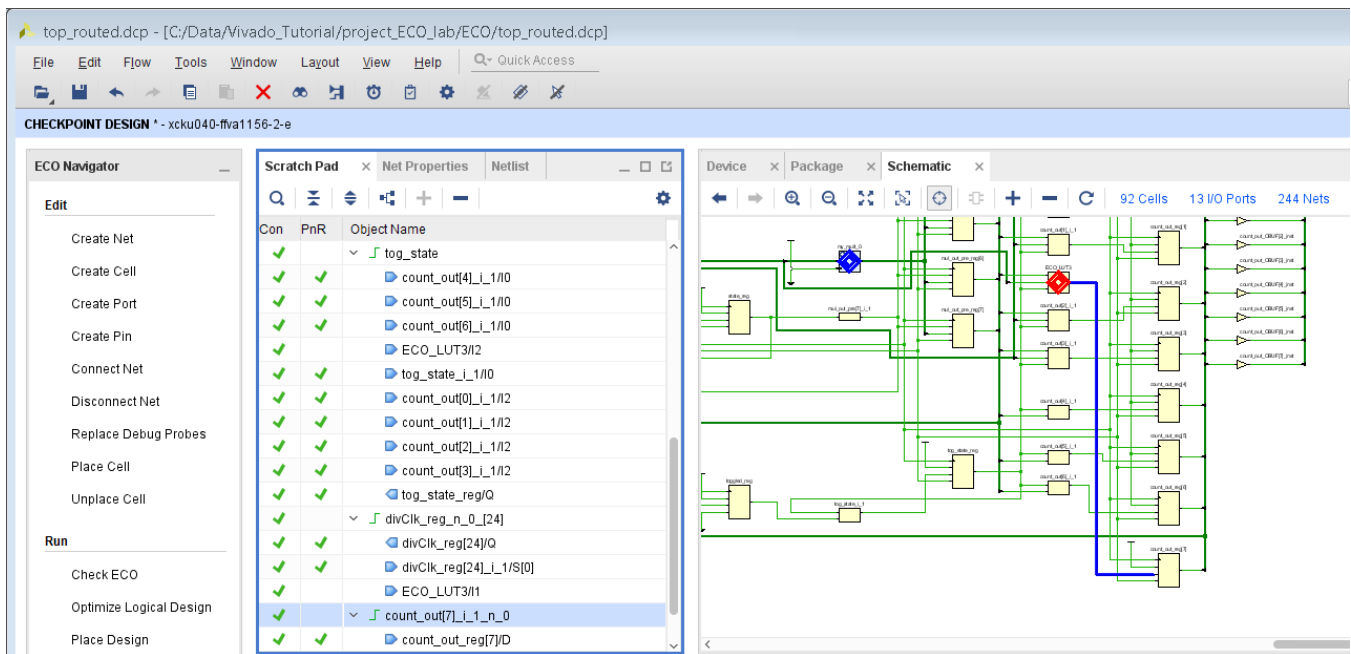

Figure 100: Connecting ECO_LUT3 Output

The ECO modifications are complete.

Step 5: Implementing the ECO Changes

Before you place and route the updates, you need to check for any illegal logical connections or other logical issues introduced during the ECO that would prevent a successful implementation of your changes.

1. In the Vivado ECO Navigator, under **Run**, click **Check ECO**.

The following figure shows the messages generated by the ECO DRC.

- The two Critical Warnings are due to the partially routed signals that are a result of the ECO and will be cleaned up during incremental place and route.
- The Warning message is due to nets in the debug hub instance that do not drive any loads. This Warning can be ignored.
- No other warnings were issued and you are ready to implement the changes.

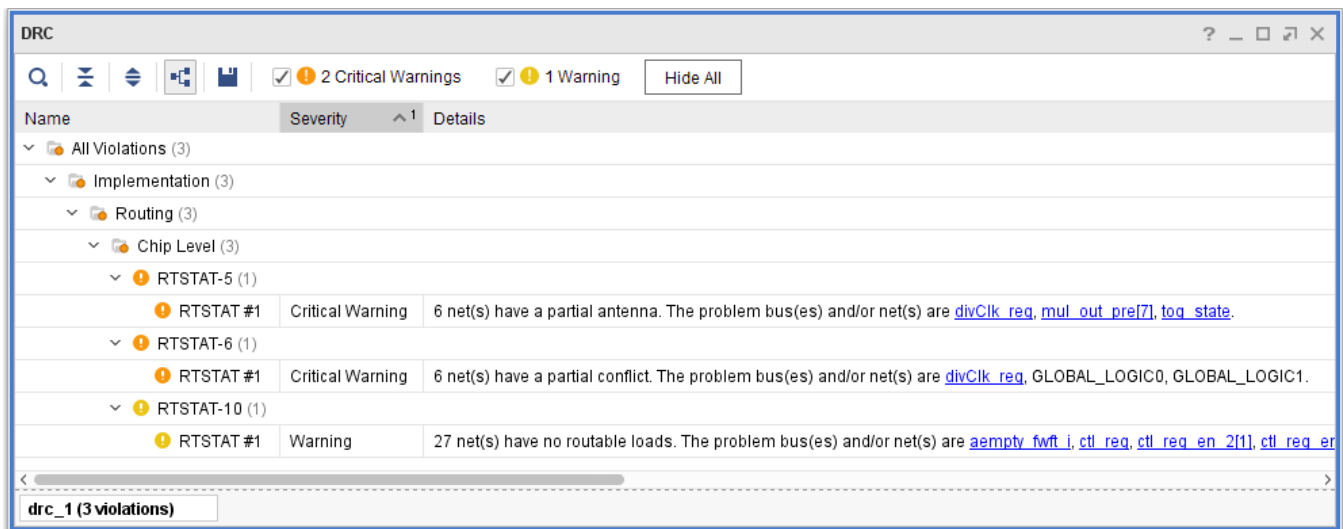

Figure 101: Check ECO DRC Messages

Because you added additional logic, you need to place the logic using the incremental place, and then route the updated net connections using incremental route.

2. In the Vivado ECO Navigator, under **Run**, click **Place Design**.

The Place Design dialog box opens, allowing you to specify additional options for the `place_design` command. For this exercise, do not specify additional options.

3. Click **OK**.

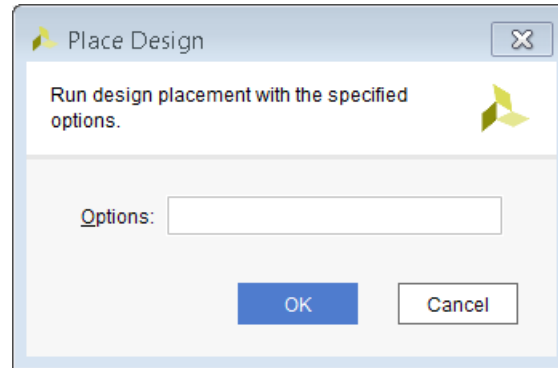

Figure 102: Place Design Dialog Box

4. Vivado runs the incremental placer.

At the end of the `place_design` step, the incremental Placement Summary is displayed in the Tcl Console.

```

+-----+
|Incremental Placement Summary                               |
+-----+
|                Type                | Count | Percentage |
+-----+
| Total instances                    | 4880 | 100.00 |
| Reused instances                    | 4878 | 99.96 |
| Non-reused instances                | 2 | 0.04 |
|   New                               | 1 | 0.02 |
|   Discarded illegal placement due to netlist changes | 1 | 0.02 |
+-----+
|Incremental Placement Runtime Summary                     |
+-----+
| Initialization time(elapsed secs)                                | 4.08 |
| Incremental Placer time(elapsed secs)                          | 7.29 |
+-----+
    
```

Figure 103: Post-Place Incremental Reuse Summary

The incremental placement summary shows that the following two cells did not have their previous placement reused:

- The new `ECO_LUT3` cell, which had to be placed from scratch
- The `count_out_reg[7]` cell, which had to get updated placement due to the placement of the `ECO_LUT3` driving it

5. In the Vivado ECO Navigator, under **Run**, click **Route Design**.

The Route Design dialog box opens.

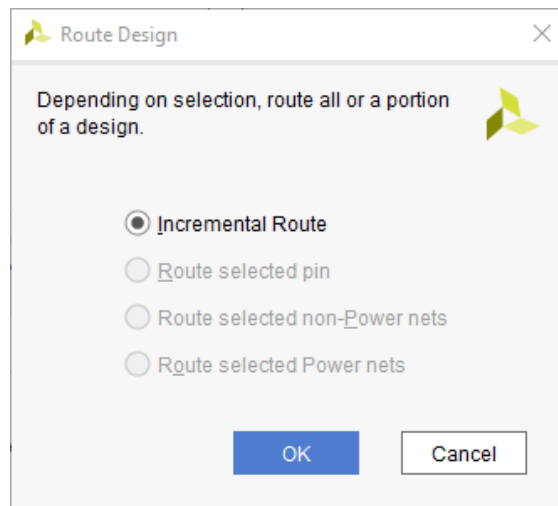

Figure 104: Route Design Dialog Box

Depending on your selection, you have four options to route the ECO changes:

- **Incremental Route:** This is the default option.
- **Route selected pin:** This option limits the route operation to the selected pin.
- **Route selected non-Power nets:** This option routes only the selected signal nets.
- **Route selected Power nets:** This option routes only the selected VCC/GND nets.

In this case, the best choice is to route the changes you made incrementally.

6. Select **Incremental Route**.

7. Click **OK**.

At the end of the `route_design` step, the incremental Routing Reuse Summary displays in the Tcl Console.

```

-----
|Incremental Routing Reuse Summary          |
-----
|Type                | Count  | Percentage |
-----
|Fully reused nets   |    3761|    99.89 |
|Partially reused nets |     3 |     0.08 |
|Non-reused nets     |     1 |     0.03 |
-----
    
```

Figure 105: Post-Route Incremental Reuse Summary

Most of the nets did not require any routing and have been fully reused.



TIP: It is a good idea to run `report_route_status` after the route operation to make sure all the nets have been routed and none have any routing issues. This is especially true if you only routed selected pins or selected nets and want to make sure you have not missed any routes.

- In the Tcl Console, run the `report_route_status` command.

The Design Route Status looks similar to the following status.

```

Design Route Status
-----
# of logical nets..... :      5160 :
# of nets not needing routing..... :    1363 :
# of internally routed nets..... :    1306 :
# of nets with no loads..... :      57 :
# of routable nets..... :    3797 :
# of fully routed nets..... :    3797 :
# of nets with routing errors..... :      0 :
-----
  
```

Figure 106: Design Route Status Post Implementation

Before you generate a bitstream, run the ECO DRCs on the design.

- In the ECO Navigator, click **Check ECO**. Make sure no Critical Warnings are generated.



Figure 107: Post Implementation Check ECO Results

- In the Vivado ECO Navigator, under **Program**, click **Save Checkpoint As**.

The Save Checkpoint As dialog box opens and you can specify a name for the checkpoint file to write to disk.

11. Click **OK** to save a checkpoint file with your changes.

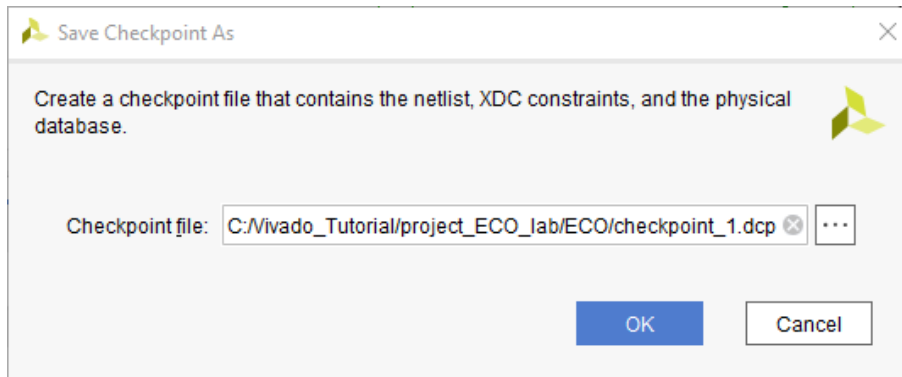

Figure 108: Saving ECO Modifications to a New Checkpoint

12. In the Vivado ECO Navigator, under **Program**, click **Generate Bitstream**.

The Generate Bitstream dialog box opens.

You can specify a name for a Bit file and select the desired options for the write_bitstream operation.

13. Click **OK** to generate a bitstream with your changes.

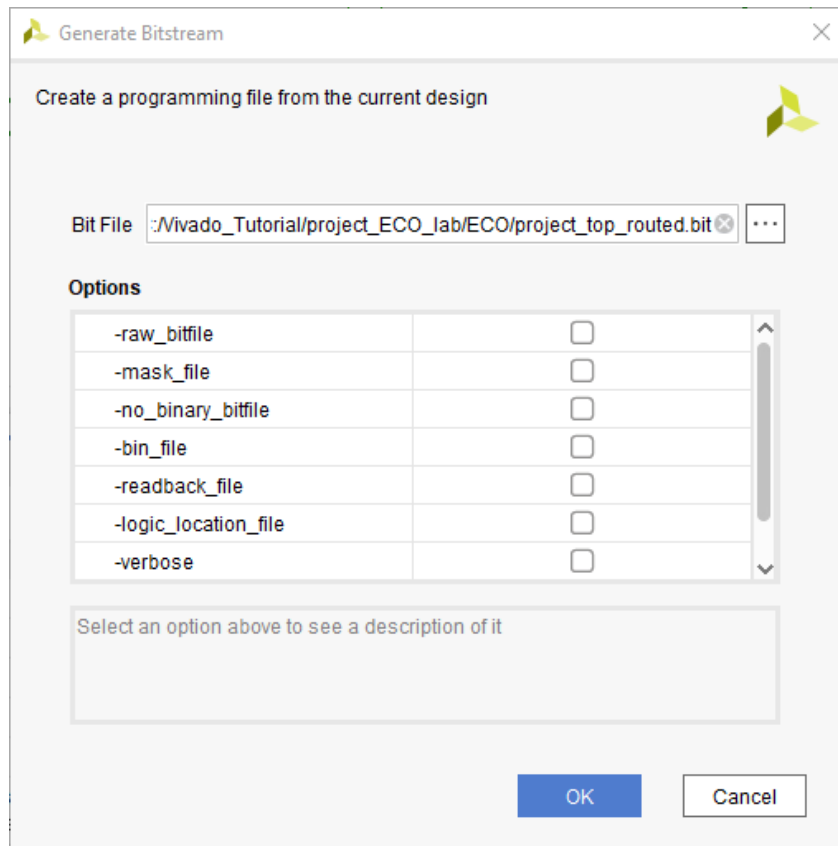

Figure 109: Generate Bitstream Dialog Box

14. In the Vivado ECO Navigator, under **Program**, click **Write Debug Probes**.

The Write Debug Probes dialog box opens.

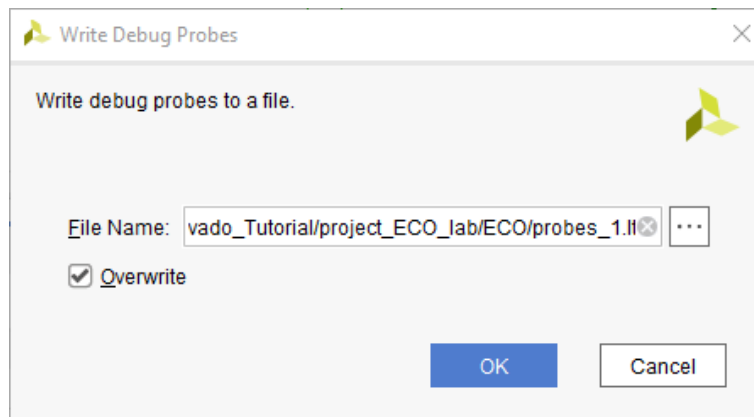

Figure 110: Write Debug Probes Dialog Box

You can specify a name for a .ltx file for your debug probes.

15. Click **OK** to generate debug probes file (LTX).

This command allows you to generate a new .ltx file for your debug probes. If you made changes to your debug probes using the **Replace Debug Probes** command, you need to save the updated information to a new debug probes file to reflect the changes in the Vivado Hardware Manager

16. Follow the instructions in Step 3: Validating the Design on the Board to download the generated bitstream programming file and debug probes file into the target FPGA device using the Hardware Manager to check your ECO modifications.

Step 6: Replacing Debug Probes

Another powerful feature of the Vivado ECO flow is the ability to replace debug probes on a previously inserted Debug Hub. After the debug probes have been replaced, a new LTX file can be generated that contains the updated debug probe information.

To replace a debug probe in your previously modified design, do the following:

1. From the main menu, select **File > Checkpoint > Open**.

The Open Checkpoint dialog box opens.

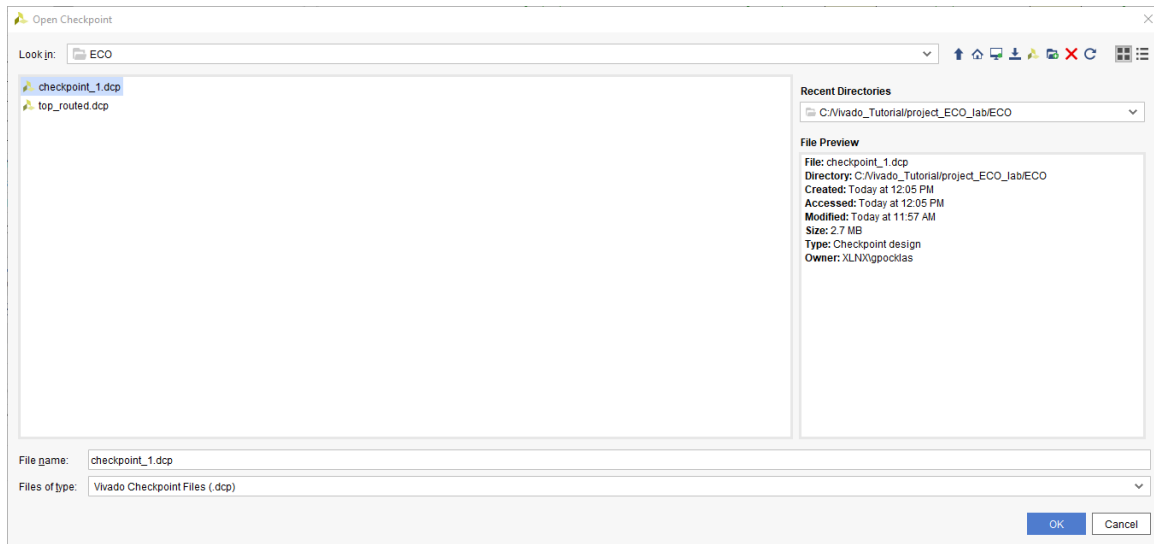



Figure 111: Open Checkpoint Dialog Box

2. Browse to the `C:/Data/Vivado_Tutorial/project_ECO_lab/ECO` directory and select the previously saved `checkpoint_1.dcp` file.
3. Close any previously open checkpoints.
4. From the main menu, select **Layout > ECO**.
5. In the Vivado ECO Navigator, under **Edit**, click **Replace Debug Probes**.

The Replace Debug Probes dialog box opens.

In this example, you will replace the net `reset_vio` that is connected to `probe4` of `u_ila_0` with the net `toggle_vio`.

6. Scroll to the bottom of the probes for `u_ila_0` in the Replace Debug Probes dialog and click the `reset_vio` net name in the Probe column to select it.
7. Click the **Edit Probes** button .

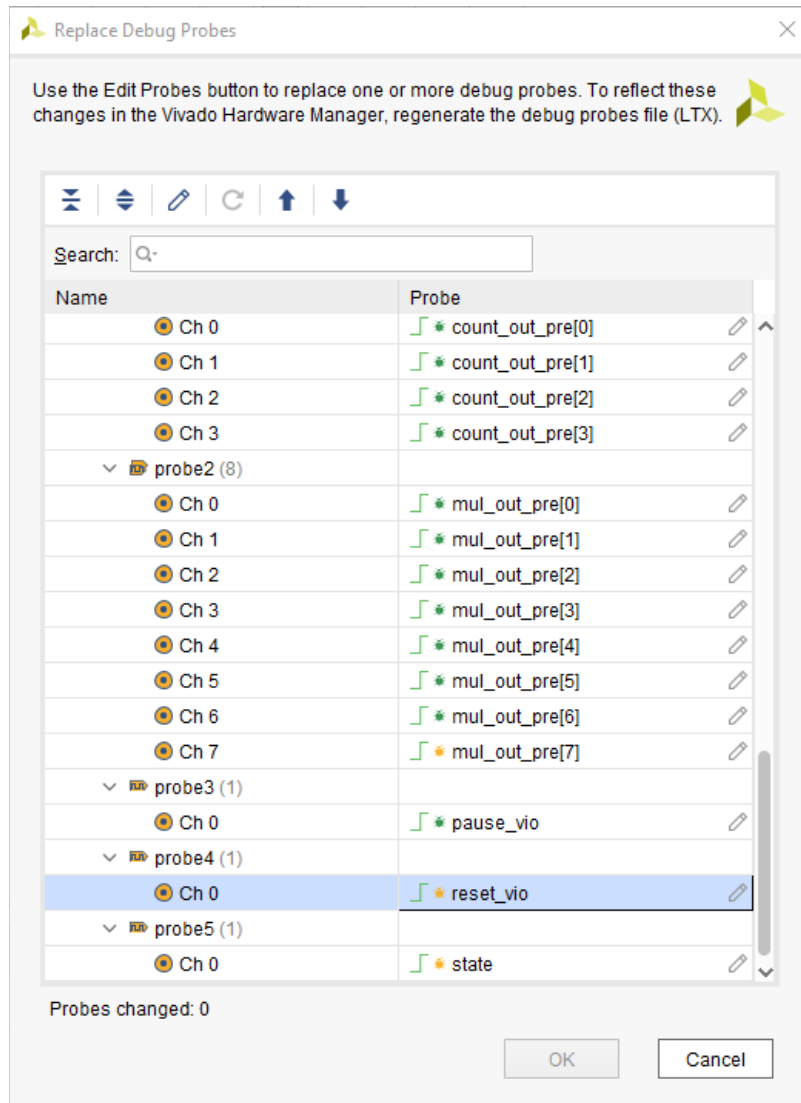

Figure 112: Replace Debug Probes Dialog Box

The Choose Nets window opens.

8. Choose a new net to connect to the debug probe `probe4` by doing the following:
 - a. Type **toggle_vio** in the search field of the Choose Nets dialog box.
 - b. Click **Find**.
 - c. Select the `toggle_vio` net, and move it to the **Selected names** section.
 - d. Click **OK**.

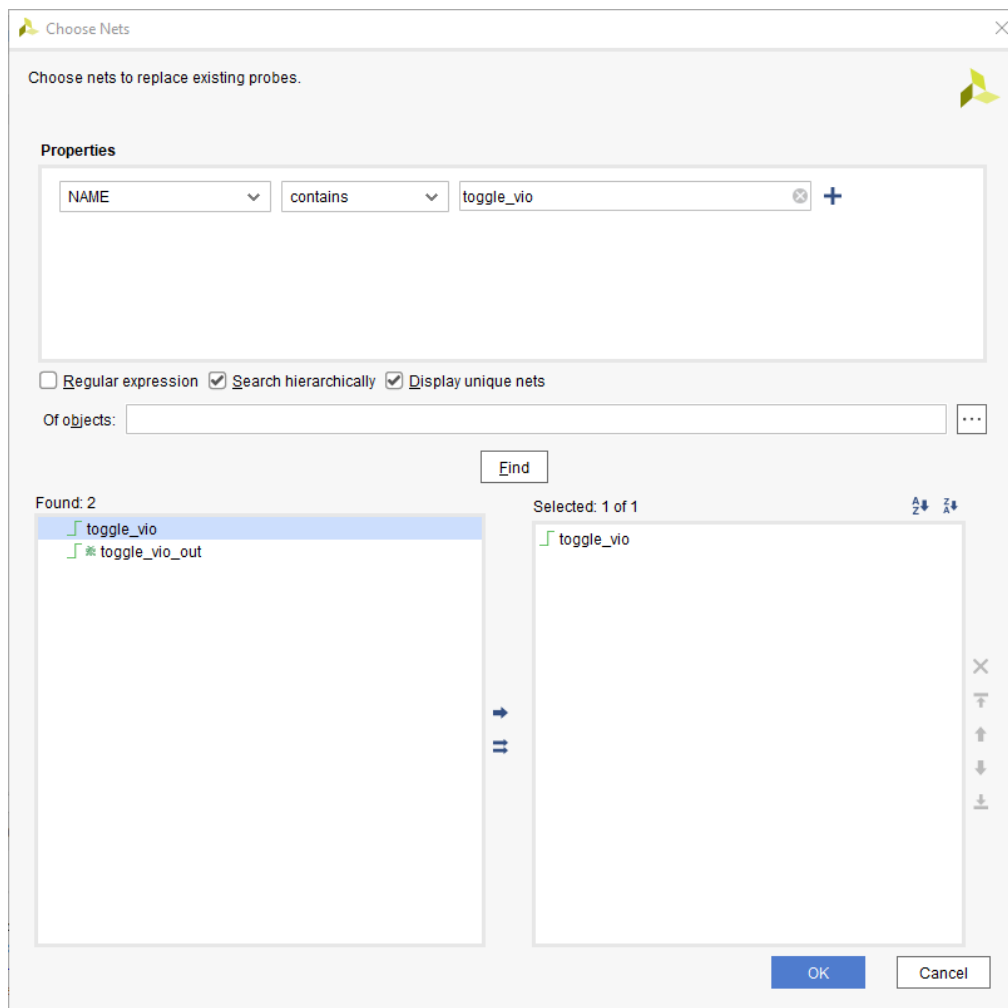

Figure 113: Choose Nets Dialog Box

9. In the Replace Debug Probes dialog box, click **OK**.
10. Repeat steps 5 through 14 of [Step 5: Implementing the ECO Changes](#) to generate an updated design checkpoint, bitstream file, and probes file (LTX).

The updated debug probes file has the `reset_vio` net for `probe4` replaced with net `toggle_vio`, which you can verify when you program the device with the updated bit file and debug probes file.

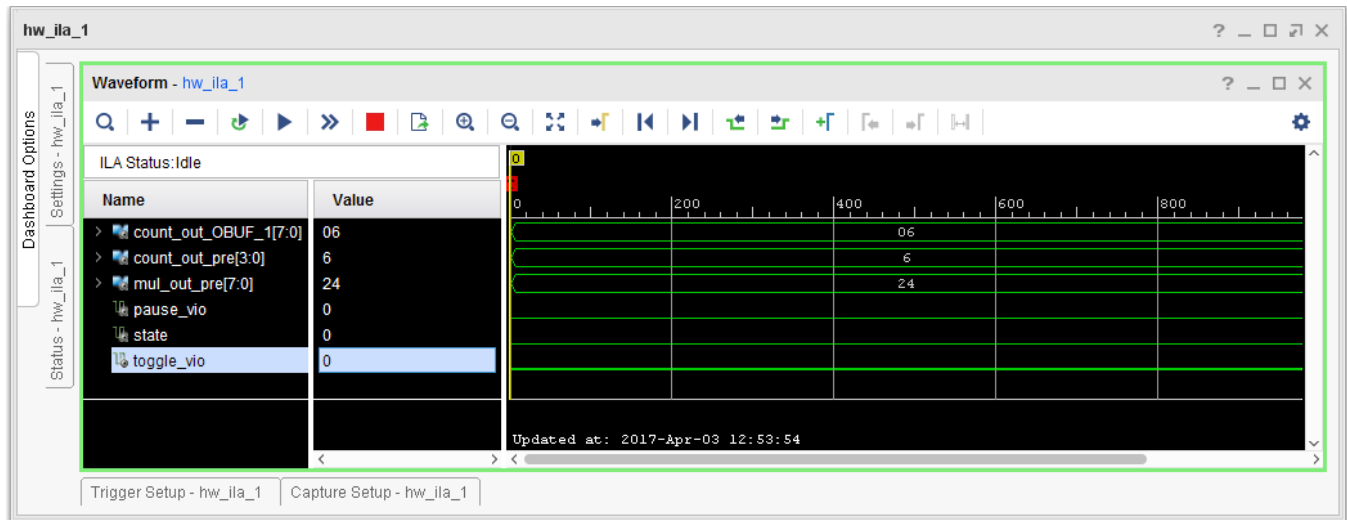

Figure 114: ILA Waveform with Update Debug Probes

Conclusion

In this lab, you did the following:

- Made changes to the previously implemented design using the Vivado ECO flow.
- Implemented the changes using incremental place and route.
- Generated a bitstream and probes file with your changes to configure the FPGA.
- Used the Replace Debug Probes command to switch the sources for debug probes in the design.

Please Read: Important Legal Notices

The information disclosed to you hereunder (the "Materials") is provided solely for the selection and use of Xilinx products. To the maximum extent permitted by applicable law: (1) Materials are made available "AS IS" and with all faults, Xilinx hereby DISCLAIMS ALL WARRANTIES AND CONDITIONS, EXPRESS, IMPLIED, OR STATUTORY, INCLUDING BUT NOT LIMITED TO WARRANTIES OF MERCHANTABILITY, NON-INFRINGEMENT, OR FITNESS FOR ANY PARTICULAR PURPOSE; and (2) Xilinx shall not be liable (whether in contract or tort, including negligence, or under any other theory of liability) for any loss or damage of any kind or nature related to, arising under, or in connection with, the Materials (including your use of the Materials), including for any direct, indirect, special, incidental, or consequential loss or damage (including loss of data, profits, goodwill, or any type of loss or damage suffered as a result of any action brought by a third party) even if such damage or loss was reasonably foreseeable or Xilinx had been advised of the possibility of the same. Xilinx assumes no obligation to correct any errors contained in the Materials or to notify you of updates to the Materials or to product specifications. You may not reproduce, modify, distribute, or publicly display the Materials without prior written consent. Certain products are subject to the terms and conditions of Xilinx's limited warranty, please refer to Xilinx's Terms of Sale which can be viewed at <https://www.xilinx.com/legal.htm#tos>; IP cores may be subject to warranty and support terms contained in a license issued to you by Xilinx. Xilinx products are not designed or intended to be fail-safe or for use in any application requiring fail-safe performance; you assume sole risk and liability for use of Xilinx products in such critical applications, please refer to Xilinx's Terms of Sale which can be viewed at <https://www.xilinx.com/legal.htm#tos>.

AUTOMOTIVE APPLICATIONS DISCLAIMER

AUTOMOTIVE PRODUCTS (IDENTIFIED AS "XA" IN THE PART NUMBER) ARE NOT WARRANTED FOR USE IN THE DEPLOYMENT OF AIRBAGS OR FOR USE IN APPLICATIONS THAT AFFECT CONTROL OF A VEHICLE ("SAFETY APPLICATION") UNLESS THERE IS A SAFETY CONCEPT OR REDUNDANCY FEATURE CONSISTENT WITH THE ISO 26262 AUTOMOTIVE SAFETY STANDARD ("SAFETY DESIGN"). CUSTOMER SHALL, PRIOR TO USING OR DISTRIBUTING ANY SYSTEMS THAT INCORPORATE PRODUCTS, THOROUGHLY TEST SUCH SYSTEMS FOR SAFETY PURPOSES. USE OF PRODUCTS IN A SAFETY APPLICATION WITHOUT A SAFETY DESIGN IS FULLY AT THE RISK OF CUSTOMER, SUBJECT ONLY TO APPLICABLE LAWS AND REGULATIONS GOVERNING LIMITATIONS ON PRODUCT LIABILITY.

© Copyright 2012-2019 Xilinx, Inc. Xilinx, the Xilinx logo, Artix, ISE, Kintex, Spartan, Virtex, Zynq, and other designated brands included herein are trademarks of Xilinx in the United States and other countries. All other trademarks are the property of their respective owners.