

# System Generator for DSP

## *User Guide*

UG640 (v 14.3) October 16, 2012

This document applies to the following software versions: ISE Design Suite 14.3 through 14.7





Xilinx is disclosing this user guide, manual, release note, and/or specification (the "Documentation") to you solely for use in the development of designs to operate with Xilinx hardware devices. You may not reproduce, distribute, republish, download, display, post, or transmit the Documentation in any form or by any means including, but not limited to, electronic, mechanical, photocopying, recording, or otherwise, without the prior written consent of Xilinx. Xilinx expressly disclaims any liability arising out of your use of the Documentation. Xilinx reserves the right, at its sole discretion, to change the Documentation without notice at any time. Xilinx assumes no obligation to correct any errors contained in the Documentation, or to advise you of any corrections or updates. Xilinx expressly disclaims any liability in connection with technical support or assistance that may be provided to you in connection with the Information.

THE DOCUMENTATION IS DISCLOSED TO YOU "AS-IS" WITH NO WARRANTY OF ANY KIND. XILINX MAKES NO OTHER WARRANTIES, WHETHER EXPRESS, IMPLIED, OR STATUTORY, REGARDING THE DOCUMENTATION, INCLUDING ANY WARRANTIES OF MERCHANTABILITY, FITNESS FOR A PARTICULAR PURPOSE, OR NONINFRINGEMENT OF THIRD-PARTY RIGHTS. IN NO EVENT WILL XILINX BE LIABLE FOR ANY CONSEQUENTIAL, INDIRECT, EXEMPLARY, SPECIAL, OR INCIDENTAL DAMAGES, INCLUDING ANY LOSS OF DATA OR LOST PROFITS, ARISING FROM YOUR USE OF THE DOCUMENTATION.

© Copyright 2006 - 2012. Xilinx, Inc. XILINX, the Xilinx logo, Artix, ISE, Kintex, Spartan, Virtex, and other designated brands included herein are trademarks of Xilinx in the United States and other countries. All other trademarks are the property of their respective owners.

---

# Table of Contents

---

## Chapter 1: Hardware Design Using System Generator

<b>A Brief Introduction to FPGAs</b> .....	10
Note to the DSP Engineer .....	14
Note to the Hardware Engineer .....	15
<b>Design Flows using System Generator</b> .....	15
Algorithm Exploration .....	15
Implementing Part of a Larger Design .....	15
Implementing a Complete Design .....	16
<b>System-Level Modeling in System Generator</b> .....	17
System Generator Blocksets .....	18
Signal Types .....	20
Floating-Point Data Type .....	21
AXI Signal Groups .....	24
Bit-True and Cycle-True Modeling .....	24
Timing and Clocking .....	25
Synchronization Mechanisms .....	36
Block Masks and Parameter Passing .....	37
Resource Estimation .....	39
<b>Automatic Code Generation</b> .....	39
Compiling and Simulating Using the System Generator Token .....	40
Viewing ISE Reports .....	44
Compilation Results .....	44
HDL Testbench .....	50
<b>Compiling MATLAB into an FPGA</b> .....	51
Simple Selector .....	51
Simple Arithmetic Operations .....	52
Complex Multiplier with Latency .....	55
Shift Operations .....	56
Passing Parameters into the MCode Block .....	57
Optional Input Ports .....	60
Finite State Machines .....	62
Parameterizable Accumulator .....	63
FIR Example and System Verification .....	66
RPN Calculator .....	69
Example of disp Function .....	71
<b>Importing a System Generator Design into a Bigger System</b> .....	73
HDL Netlist Compilation .....	73
Integration Design Rules .....	73
New Integration Flow between System Generator & Project Navigator .....	74
A Step-by-Step Example .....	75
<b>Generating a PlanAhead Project File from System Generator</b> .....	82
Step-by-Step Example for Generating a PlanAhead Project File .....	82
<b>Importing a System Generator Design into PlanAhead</b> .....	86
Steps to Import a System Generator Design as a Sub-Module .....	86
Creating a New System Generator Design from within PlanAhead .....	87
<b>Configurable Subsystems and System Generator</b> .....	88

Defining a Configurable Subsystem . . . . .	88
Using a Configurable Subsystem . . . . .	90
Deleting a Block from a Configurable Subsystem . . . . .	91
Adding a Block to a Configurable Subsystem . . . . .	91
Generating Hardware from Configurable Subsystems . . . . .	92
<b>Notes for Higher Performance FPGA Design . . . . .</b>	<b>94</b>
Review the Hardware Notes Included with Each Block Dialog Box . . . . .	94
Register the Inputs and Outputs of Your Design . . . . .	94
Insert Pipeline Registers . . . . .	95
Use Saturation Arithmetic and Rounding Only When Necessary . . . . .	97
Use the System Generator Timing and Power Analysis Tools . . . . .	97
Set the Data Rate Option on All Gateway Blocks . . . . .	97
Reduce the Clock Enable (CE) Fanout . . . . .	97
Experiment with Different Synthesis Settings . . . . .	98
Other Things to Try . . . . .	98
<b>Processing a System Generator Design with FPGA Physical Design Tools . . . . .</b>	<b>99</b>
HDL Simulation . . . . .	99
Generating an FPGA Bitstream . . . . .	102
<b>Resetting Auto-Generated Clock Enable Logic . . . . .</b>	<b>105</b>
ce_clr and Rate Changing Blocks . . . . .	105
ce_clr Usage Recommendations . . . . .	107
<b>Design Styles for the DSP48 . . . . .</b>	<b>108</b>
About the DSP48 . . . . .	108
Designs Using Standard Components . . . . .	109
Designs Using Synthesizable Mult, Mux and AddSub Blocks . . . . .	109
Designs that Use DSP48 and DSP48 Macro Blocks . . . . .	110
DSP48 Design Techniques . . . . .	115
<b>Using FDATool in Digital Filter Applications . . . . .</b>	<b>118</b>
Design Overview . . . . .	119
Open and Generate the Coefficients for this FIR Filter . . . . .	119
Parameterize the MAC-Based FIR Block . . . . .	120
Generate and Assign Coefficients for the FIR Filter . . . . .	121
Browse Through and Understand the Xilinx Filter Block . . . . .	123
Run the Simulation . . . . .	124
<b>Generating Multiple Cycle-True Islands for Distinct Clocks . . . . .</b>	<b>127</b>
Multiple Clock Applications . . . . .	127
Clock Domain Partitioning . . . . .	128
Crossing Clock Domains . . . . .	129
Netlisting Multiple Clock Designs . . . . .	130
Step-by-Step Example . . . . .	131
Creating a Top-Level Wrapper . . . . .	135
<b>Using ChipScope Pro Analyzer for Real-Time Hardware Debugging . . . . .</b>	<b>139</b>
ChipScope Pro Overview . . . . .	139
Tutorial Example: Using ChipScope in System Generator . . . . .	139
Real-Time Debug . . . . .	145
Tutorial Example: Using ChipScope Pro Analyzer with JTAG Hardware Co-Simulation . . . . .	149
<b>AXI Interface . . . . .</b>	<b>151</b>
Introduction . . . . .	151
AXI4 Support in System Generator . . . . .	151
AXI4-Stream Support in System Generator . . . . .	152
AXI-Stream Blocks in System Generator . . . . .	153



## : Hardware/Software Co-Design

<b>Hardware/Software Co-Design in System Generator</b> .....	156
Black Box Block .....	156
PicoBlaze Block .....	156
EDK Processor Block .....	156
<b>Integrating a Processor with Custom Logic</b> .....	156
Memory Map Creation .....	158
Hardware Generation .....	159
Hardware Co-Simulation .....	159
The Software Driver .....	160
Writing a Software Program .....	163
Asynchronous Support .....	166
Clock Wiring in the Hardware Co-Simulation Flow .....	167
<b>EDK Support</b> .....	175
Importing an EDK Processor .....	175
Exposing Processor Ports to System Generator .....	177
Exporting a pcore .....	178
<b>Designing with Embedded Processors and Microcontrollers</b> .....	178
Designing PicoBlaze Microcontroller Applications .....	178
Designing and Exporting MicroBlaze Processor Peripherals .....	184
Using XPS .....	200
Using Platform Studio SDK .....	205
Tutorial Example - Using System Generator and SDK to Co-Debug an Embedded DSP Design	
214	
Summary .....	237

## Chapter 3: Using Hardware Co-Simulation

Introduction .....	239
M-Code Access to Hardware Co-Simulation .....	239
<b>Installing Your Hardware Board</b> .....	239
Ethernet-Based Hardware Co-Simulation .....	239
JTAG-Based Hardware Co-Simulation .....	240
Third-Party Hardware Co-Simulation .....	240
<b>Compiling a Model for Hardware Co-Simulation</b> .....	241
Choosing a Compilation Target .....	241
Invoking the Code Generator .....	241
<b>Hardware Co-Simulation Blocks</b> .....	242
<b>Hardware Co-Simulation Clocking</b> .....	245
Selecting the Target Clock Frequency .....	245
Clocking Modes .....	246
Selecting the Clock Mode .....	246
<b>Board-Specific I/O Ports</b> .....	247
I/O Ports in Hardware Co-simulation .....	248
<b>Ethernet Hardware Co-Simulation</b> .....	248
Point-to-Point Ethernet Hardware Co-Simulation .....	249
Network-Based Ethernet Hardware Co-Simulation .....	253
Remote JTAG Cable Support in JTAG Co-Simulation .....	254
<b>Shared Memory Support</b> .....	256
Compiling Shared Memories for Hardware Co-Simulation .....	257
Co-Simulating Unprotected Shared Memories .....	259

Co-Simulating Lockable Shared Memories .....	260
Co-Simulating Shared Registers .....	262
Co-Simulating Shared FIFOs .....	263
Restrictions on Shared Memories .....	266
<b>Specifying Xilinx Tool Flow Settings .....</b>	<b>266</b>
<b>Frame-Based Acceleration using Hardware Co-Simulation .....</b>	<b>268</b>
Shared Memories .....	268
Adding Buffers to a Design .....	270
Compiling for Hardware Co-simulation .....	274
Using Vector Transfers .....	276
<b>Real-Time Signal Processing using Hardware Co-Simulation .....</b>	<b>281</b>
Shared Memory I/O Buffering Example .....	281
Applying a 5x5 Filter Kernel Data Path .....	283
5x5 Filter Kernel Test Bench .....	286
Reloading the Kernel .....	290
<b>Installing Your Board for Ethernet Hardware Co-Simulation .....</b>	<b>291</b>
Installing Software on the Host PC .....	291
Setting Up the Local Area Network on the PC .....	291
Loading the Sysgen HW Co-Sim Configuration Files .....	293
Installing the Proxy Executable for Linux Users .....	295
Installing an ML402 Board for Ethernet Hardware Co-Simulation .....	295
Installing an ML506 Board for Ethernet Hardware Co-Simulation .....	300
Installing an ML605 Board for Ethernet Hardware Co-Simulation .....	305
Installing a Spartan-3A DSP 1800A Starter Board for Ethernet Hardware Co-Simulation .....	307
Installing a Spartan-3A DSP 3400A Board for Ethernet Hardware Co-Simulation .....	308
Installing an SP601/SP605 Board for Ethernet Hardware Co-Simulation .....	313
<b>Installing Your Board for JTAG Hardware Co-Simulation .....</b>	<b>315</b>
Installing an ML402 Board for JTAG Hardware Co-Simulation .....	315
Installing an ML605 Board for JTAG Hardware Co-Simulation .....	317
Installing an SP601/SP605 Board for JTAG Hardware Co-Simulation .....	319
Installing a KC705 Board for JTAG Hardware Co-Simulation .....	321
<b>Supporting New Boards through JTAG Hardware Co-Simulation .....</b>	<b>323</b>
Hardware Requirements .....	323
Supporting New Boards .....	323

## Chapter 4: Importing HDL Modules

<b>Black Box HDL Requirements and Restrictions .....</b>	<b>338</b>
<b>Black Box Configuration Wizard .....</b>	<b>339</b>
<b>Black Box Configuration M-Function .....</b>	<b>340</b>
<b>HDL Co-Simulation .....</b>	<b>354</b>
Introduction .....	354
Configuring the HDL Simulator .....	354
Co-Simulating Multiple Black Boxes .....	356
<b>Black Box Examples .....</b>	<b>357</b>
Importing a Xilinx Core Generator Module .....	357
Importing a VHDL Module .....	371
Importing a Verilog Module .....	378
Dynamic Black Boxes .....	380
Simulating Several Black Boxes Simultaneously .....	382
Advanced Black Box Example Using ModelSim .....	384

Importing, Simulating, and Exporting an Encrypted VHDL File . . . . . 389  
 Black Box Tutorial Exercise 9: Prompting a User for Parameters in a Simulink Model and  
 Passing Them to a Black Box . . . . . 394

**Chapter 5: System Generator Compilation Types**

**HDL Netlist Compilation** . . . . . 398  
**NGC Netlist Compilation** . . . . . 398  
**Bitstream Compilation** . . . . . 399  
     XFLOW Option Files . . . . . 400  
     Additional Settings . . . . . 401  
     Re-Compiling EDK Processor Block Software Programs in Bitstreams . . . . . 402  
**EDK Export Tool** . . . . . 403  
     Creating a Custom Bus Interface for Pcore Export . . . . . 404  
     Export as Pcore to EDK . . . . . 405  
     System Generator Ports as Top-Level Ports in EDK . . . . . 406  
     Supported Processors and Current Limitations . . . . . 406  
     See Also: . . . . . 406  
**Hardware Co-Simulation Compilation** . . . . . 407  
**Timing and Power Analysis Compilation** . . . . . 407  
     Timing Analysis Concepts Review . . . . . 409  
     Timing Analyzer Features . . . . . 410  
**Creating Compilation Targets** . . . . . 416  
     Defining New Compilation Targets . . . . . 417

**Index** . . . . . 421



# Hardware Design Using System Generator

---

System Generator is a system-level modeling tool that facilitates FPGA hardware design. It extends Simulink in many ways to provide a modeling environment that is well suited to hardware design. The tool provides high-level abstractions that are automatically compiled into an FPGA at the push of a button. The tool also provides access to underlying FPGA resources through low-level abstractions, allowing the construction of highly efficient FPGA designs.

<a href="#">A Brief Introduction to FPGAs</a>	Provides background on FPGAs, and discusses compilation, programming, and architectural considerations in the context of System Generator.
<a href="#">Design Flows using System Generator</a>	Describes several settings in which constructing designs in System Generator is useful.
<a href="#">System-Level Modeling in System Generator</a>	Discusses System Generator's ability to implement device-specific hardware designs directly from a flexible, high-level, system modeling environment.
<a href="#">Automatic Code Generation</a>	Discusses automatic code generation for System Generator designs.
<a href="#">Compiling MATLAB into an FPGA</a>	Describes how to use a subset of the MATLAB programming language to write functions that describe state machines and arithmetic operators. Functions written in this way can be attached to blocks in System Generator and can be automatically compiled into equivalent HDL.
<a href="#">Importing a System Generator Design into a Bigger System</a>	Discusses how to take the VHDL netlist from a System Generator design and synthesize it in order to embed it into a larger design. Also shows how VHDL created by System Generator can be incorporated into a simulation model of the overall system.
<a href="#">Generating a PlanAhead Project File from System Generator</a>	Provides an example of how to generate a PlanAhead project file (with design strategies) and invoke PlanAhead from within System Generator.

<a href="#">Configurable Subsystems and System Generator</a>	Explains how to use configurable subsystems in System Generator. Describes common tasks such as defining configurable subsystems, deleting and adding blocks, and using configurable subsystems to import compilation results into System Generator designs.
<a href="#">Notes for Higher Performance FPGA Design</a>	Suggests design practices in System Generator that lead to an efficient and high-performance implementation in an FPGA.
<a href="#">Processing a System Generator Design with FPGA Physical Design Tools</a>	Describes how to take the low-level HDL produced by System Generator and use it in tools like Xilinx's Project Navigator, ModelSim, and Synplicity's Synplify.
<a href="#">Resetting Auto-Generated Clock Enable Logic</a>	Describes the behavior of rate changing blocks from the System Generator library when the <code>ce_clr</code> signal is used for re-synchronization.
<a href="#">Design Styles for the DSP48</a>	Describes three ways to implement and configure a DSP48 (Xtreme DSP Slice) in System Generator
<a href="#">Using FDATool in Digital Filter Applications</a>	Demonstrates one way to specify, implement and simulate a FIR filter using the FDATool block.
<a href="#">Generating Multiple Cycle-True Islands for Distinct Clocks</a>	Describes how to implement multi-clock designs in System Generator
<a href="#">Using ChipScope Pro Analyzer for Real-Time Hardware Debugging</a>	Demonstrates how to connect and use the Xilinx Debug Tool called ChipScope™ Pro within System Generator
<a href="#">AXI Interface</a>	Provides an introduction to AMBA AXI4 and draws attention to AMBA AXI4 details with respect to System Generator.

## A Brief Introduction to FPGAs

A field programmable gate array (FPGA) is a general-purpose integrated circuit that is “programmed” by the designer rather than the device manufacturer. Unlike an application-specific integrated circuit (ASIC), which can perform a similar function in an electronic system, an FPGA can be reprogrammed, even after it has been deployed into a system.

An FPGA is programmed by downloading a configuration program called a bitstream into static on-chip random-access memory. Much like the object code for a microprocessor, this bitstream is the product of compilation tools that translate the high-level abstractions produced by a designer into something equivalent but low-level and executable. Xilinx System Generator pioneered the idea of compiling an FPGA program from a high-level Simulink model.

An FPGA provides you with a two-dimensional array of configurable resources that can implement a wide range of arithmetic and logic functions. These resources include dedicated DSP blocks, multipliers, dual port memories, lookup tables (LUTs), registers, tri-state buffers, multiplexers, and digital clock managers. In addition, Xilinx FPGAs contain sophisticated I/O mechanisms that can handle a wide range of bandwidth and voltage requirements. The Virtex®-4 FPGAs include embedded microcontrollers (IBM PowerPC®

405), and multi-gigabit serial transceivers. The compute and I/O resources are linked under the control of the bitstream by a programmable interconnect architecture that allows them to be wired together into systems.

FPGAs are high performance data processing devices. DSP performance is derived from the FPGA's ability to construct highly parallel architectures for processing data. In contrast with a microprocessor or DSP processor, where performance is tied to the clock rate at which the processor can run, FPGA performance is tied to the amount of parallelism that can be brought to bear in the algorithms that make up a signal processing system. A combination of increasingly high system clock rates (current system frequencies of 100-200 MHz are common today) and a highly-distributed memory architecture gives the system designer an ability to exploit parallelism in DSP (and other) applications that operate on data streams. For example, the raw memory bandwidth of a large FPGA running at a clock rate of 150 MHz can be hundreds of terabytes per second.

There are many DSP applications (e.g., digital up/down converters) that can be implemented only in custom integrated circuits (ICs) or in an FPGA; a von Neumann processor lacks both the compute capability and the memory bandwidth required. Advantages of using an FPGA include significantly lower non-recurring engineering costs than those associated with a custom IC (FPGAs are commercial off-the-shelf devices), shorter time to market, and the configurability of an FPGA, which allows a design to be modified, even after deployment in an end application.

When working in System Generator, it is important to keep in mind that an FPGA has many degrees of freedom in implementing signal processing functions. You have, for example, the freedom to define data path widths throughout your system and to employ many individual data processors (e.g., multiply-accumulate engines), depending on system requirements. System Generator provides abstractions that allow you to design for an FPGA largely by thinking about the algorithm you want to implement. However, the more you know about the underlying FPGA, the more likely you are to exploit the unique capabilities an FPGA provides in achieving high performance.

The remainder of this topic is a brief introduction to some of the logic resources available in the FPGA, so that you gain some appreciation for the abstractions provided in System Generator.

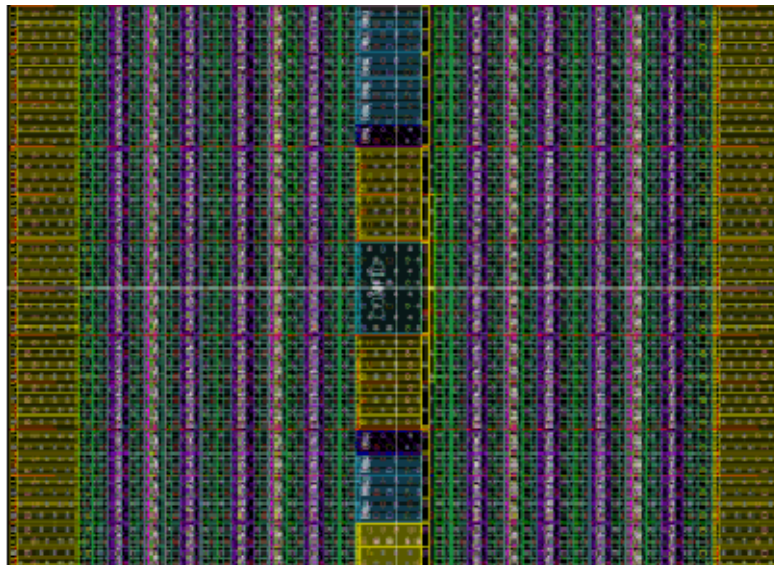



The figure above shows a physical view of a Virtex®-4 FPGA. To a signal DSP engineer, an FPGA can be thought of as a 2-D array of logic slices striped with columns of hard macro blocks (block memory and arithmetic blocks) suitable for implementing DSP functions, embedded within a configurable interconnect mesh. In a Virtex®-4 FPGA, the DSP blocks (shown in the next figure) can run in excess of 450 MHz, and are pitch-matched to dual port memory blocks (BRAMs) whose ports can be configured to a wide range of word sizes (18 Kb total per BRAM). The Virtex®-4 SX55 device contains 512 such DSP blocks and BRAMs. In System Generator, you can access all of these resources through arithmetic and logic abstractions to build very high performance digital filters, FFTs, and other arithmetic and signal processing functions.

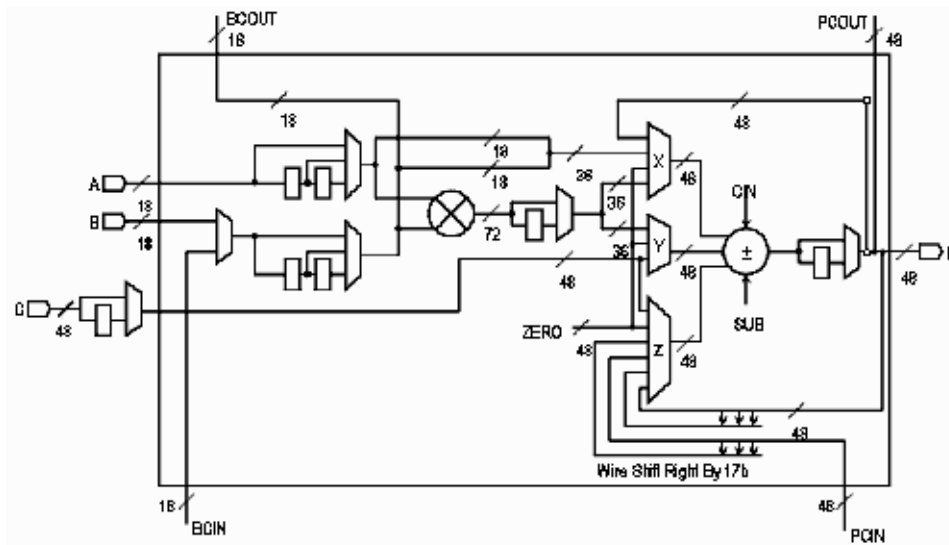

While the multiply-accumulate function supported by a Virtex®-4 DSP block is familiar to a DSP engineer, it is instructive to take a closer look at the Virtex® FPGA family logic slice (shown below), which is the fundamental unit of the logic fabric array.

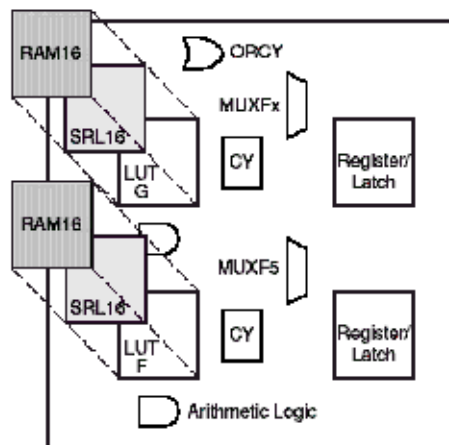

Each logic slice contains two 4-input lookup tables (LUTs), two configurable D-flip flops, multiplexers, dedicated carry logic, and gates used for creating slice-based multipliers. Each LUT can implement an arbitrary 4-input Boolean function. Coupled with dedicated logic for implementing fast carry circuits, the LUTs can also be used to build fast adder/subtractors and multipliers of essentially any word size. In addition to implementing Boolean functions, each LUT can also be configured as a 16x1 bit RAM or as



a shift register (SRL16). An SRL16 shift register is a synchronously clocked 16x1 bit delay line with a dynamically addressable tap point.

In System Generator, these different memory options are represented with higher-level abstractions. Instead of providing a D-flip flop primitive, System Generator provides a register of arbitrary size. There are two blocks that provide abstractions of arbitrary width, arbitrary depth delay lines that map directly onto the SRL16 configuration. The delay block can be used for pipeline balancing, and can also be used as storage for time-division multiplexed (TDM) data streams. The addressable shift register (ASR) block, with a function depicted in the figure below, provides an arbitrary width, arbitrary depth tapped delay line. This block is of particular interest to the DSP engineer, since it can be used to implement tapped delay lines as well as sweeping through TDM data streams.

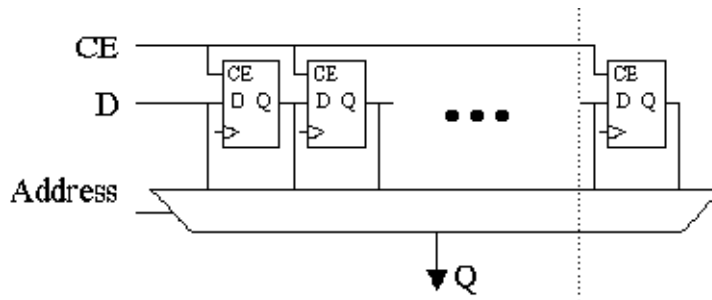

Although random access memories can be constructed either out of the BRAM or LUT (RAM16x1) primitives, doing so can require considerable care to ensure most efficient mappings, and considerable clerical attention to detail to correctly assemble the primitives into larger structures. System Generator removes the need for such tasks.

For example, the dual port RAM (DPRAM) block shown in the figure below maps efficiently onto as many BRAM or RAM16x1 components on the device as are necessary to implement the desired memory. As can be seen from the mask dialog box for the DPRAM, the interface allows you to specify a type of memory (BRAM or RAM16x1), depth (data

width is inferred from the Simulink signal driving a particular input port), initial memory contents, and other characteristics.

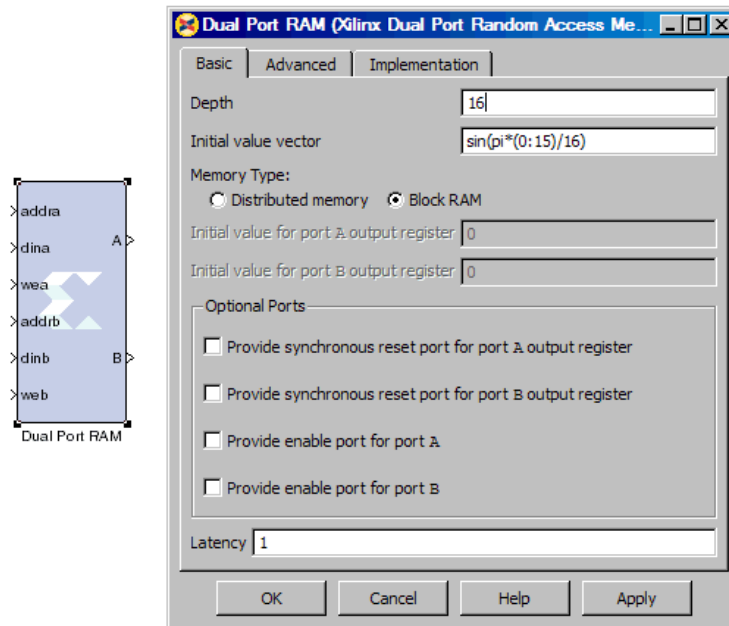

In general, System Generator maps abstractions onto device primitives efficiently, freeing you from worrying about interconnections between the primitives. System Generator employs libraries of intellectual property (IP) when appropriate to provide efficient implementations of functions in the block libraries. In this way, you don't always have to have detailed knowledge of the underlying FPGA details. However, when it makes sense to implement an algorithm using basic functions (e.g., adder, register, memory), System Generator allows you to exploit your FPGA knowledge while reducing the clerical tasks of managing all signals explicitly.

System Generator library blocks and the mapping from Simulink to hardware are described in detail in subsequent topics of this documentation. There is a wealth of detailed information about FPGAs that can be found online at <http://support.xilinx.com>, including data books, application notes, white papers, and technical articles.

## Note to the DSP Engineer

System Generator extends Simulink to enable hardware design, providing high-level abstractions that can be automatically compiled into an FPGA. Although the arithmetic abstractions are suitable to Simulink (discrete time and space dynamical system simulation), System Generator also provides access to features in the underlying FPGA.

The more you know about a hardware realization (e.g., how to exploit parallelism and pipelining), the better the implementation you'll obtain. Using IP cores makes it possible to have efficient FPGA designs that include complex functions like FFTs. System Generator also makes it possible to refine a model to more accurately fit the application.

Scattered throughout the System Generator documentation are notes that explain ways in which system parameters can be used to exploit hardware capabilities.

## Note to the Hardware Engineer

System Generator does not replace hardware description language (HDL)-based design, but does make it possible to focus your attention only on the critical parts. By analogy, most DSP programmers do not program exclusively in assembler; they start in a higher-level language like C, and write assembly code only where it is required to meet performance requirements.

A good rule of thumb is this: in the parts of the design where you must manage internal hardware clocks (e.g., using the DDR or phased clocking), you should implement using HDL. The less critical portions of the design can be implemented in System Generator, and then the HDL and System Generator portions can be connected. Usually, most portions of a signal processing system do not need this level of control, except at external interfaces. System Generator provides mechanisms to import HDL code into a design (see [Importing HDL Modules](#)) that are of particular interest to the HDL designer.

Another aspect of System Generator that is of interest to the engineer who designs using HDL is its ability to automatically generate an HDL testbench, including test vectors. This aspect is described in the topic [HDL Testbench](#).

Finally, the hardware co-simulation interfaces described in the topic [Using Hardware Co-Simulation](#) allow you to run a design in hardware under the control of Simulink, bringing the full power of MATLAB and Simulink to bear for data analysis and visualization.

## Design Flows using System Generator

System Generator can be useful in many settings. Sometimes you may want to explore an algorithm without translating the design into hardware. Other times you might plan to use a System Generator design as part of something bigger. A third possibility is that a System Generator design is complete in its own right, and is to be used in FPGA hardware. This topic describes all three possibilities.

### Algorithm Exploration

System Generator is particularly useful for algorithm exploration, design prototyping, and model analysis. When these are the goals, you can use the tool to flesh out an algorithm in order to get a feel for the design problems that are likely to be faced, and perhaps to estimate the cost and performance of an implementation in hardware. The work is preparatory, and there is little need to translate the design into hardware.

In this setting, you assemble key portions of the design without worrying about fine points or detailed implementation. Simulink blocks and MATLAB M-code provide stimuli for simulations, and for analyzing results. Resource estimation gives a rough idea of the cost of the design in hardware. Experiments using hardware generation can suggest the hardware speeds that are possible.

Once a promising approach has been identified, the design can be fleshed out. System Generator allows refinements to be done in steps, so some portions of the design can be made ready for implementation in hardware, while others remain high-level and abstract. System Generator's facilities for hardware co-simulation are particularly useful when portions of a design are being refined.

### Implementing Part of a Larger Design

Often System Generator is used to implement a portion of a larger design. For example, System Generator is a good setting in which to implement data paths and control, but is

less well suited for sophisticated external interfaces that have strict timing requirements. In this case, it may be useful to implement parts of the design using System Generator, implement other parts outside, and then combine the parts into a working whole.

A typical approach to this flow is to create an HDL wrapper that represents the entire design, and to use the System Generator portion as a component. The non-System Generator portions of the design can also be components in the wrapper, or can be instantiated directly in the wrapper.

## Implementing a Complete Design

Many times, everything needed for a design is available inside System Generator. For such a design, pressing the **Generate** button instructs System Generator to translate the design into HDL, and to write the files needed to process the HDL using downstream tools. The files written include the following:

- HDL that implements the design itself;
- A clock wrapper that encloses the design. This clock wrapper produces the clock and clock enable signals that the design needs.
- A HDL testbench that encloses the clock wrapper. The testbench allows results from Simulink simulations to be compared against ones produced by a logic simulator.
- Project files and scripts that allow various synthesis tools, such as XST and Synplify Pro to operate on System Generator HDL
- Files that allow the System Generator HDL to be used as a project in Project Navigator.

For details concerning the files that System Generator writes, see the topic [Compilation Results](#).

## System-Level Modeling in System Generator

System Generator allows device-specific hardware designs to be constructed directly in a flexible high-level system modeling environment. In a System Generator design, signals are not just bits. They can be signed and unsigned fixed-point numbers, and changes to the design automatically translate into appropriate changes in signal types. Blocks are not just stand-ins for hardware. They respond to their surroundings, automatically adjusting the results they produce and the hardware they become.

System Generator allows designs to be composed from a variety of ingredients. Data flow models, traditional hardware design languages (VHDL, Verilog, and EDIF), and functions derived from the MATLAB programming language, can be used side-by-side, simulated together, and synthesized into working hardware. System Generator simulation results are bit and cycle-accurate. This means results seen in simulation exactly match the results that are seen in hardware. System Generator simulations are considerably faster than those from traditional HDL simulators, and results are easier to analyze.

<a href="#">System Generator Blocksets</a>	Describes how System Generator's blocks are organized in libraries, and how the blocks can be parameterized and used.
<a href="#">Signal Types</a>	Describes the data types used by System Generator and ways in which data types can be automatically assigned by the tool.
<a href="#">Bit-True and Cycle-True Modeling</a>	Specifies the relationship between the Simulink-based simulation of a System Generator model and the behavior of the hardware that can be generated from it.
<a href="#">Timing and Clocking</a>	Describes how clocks are implemented in hardware, and how their implementation is controlled inside System Generator. Explains how System Generator translates a multirate Simulink model into working clock-synchronous hardware.
<a href="#">Synchronization Mechanisms</a>	Describes mechanisms that can be used to synchronize data flow across the data path elements in a high-level System Generator design, and describes how control path functions can be implemented.
<a href="#">Block Masks and Parameter Passing</a>	Explains how parameterized systems and subsystems are created in Simulink.
<a href="#">Resource Estimation</a>	Describes how to generate estimates of the hardware needed to implement a System Generator design.

## System Generator Blocksets

A *Simulink blockset* is a library of blocks that can be connected in the Simulink block editor to create functional models of a dynamical system. For system modeling, System Generator blocksets are used like other Simulink blocksets. The blocks provide abstractions of mathematical, logic, memory, and DSP functions that can be used to build sophisticated signal processing (and other) systems. There are also blocks that provide interfaces to other software tools (e.g., FDATool, ModelSim) as well as the System Generator code generation software.

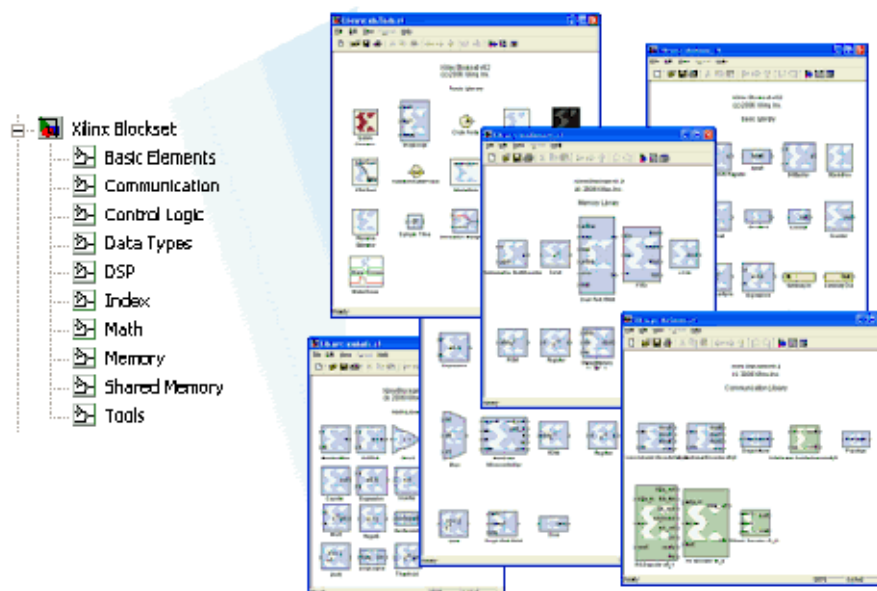

System Generator blocks are *bit-accurate* and *cycle-accurate*. Bit-accurate blocks produce values in Simulink that match corresponding values produced in hardware; cycle-accurate blocks produce corresponding values at corresponding times.

## Xilinx Blockset

The Xilinx Blockset is a family of libraries that contain basic System Generator blocks. Some blocks are low-level, providing access to device-specific hardware. Others are high-level, implementing (for example) signal processing and advanced communications algorithms. For convenience, blocks with broad applicability (e.g., the Gateway I/O blocks) are members of several libraries. Every block is contained in the Index library. The libraries are described below.

**Note:** It is important that you don't name your design the same as a Xilinx block. For example, if you name your design **shared\_memory.mdl**, it may cause System Generator to issue an error message.

Library	Description
AXI4	Blocks with interfaces that conform to the AXI™4 specification
Basic Elements	ElementsStandard building blocks for digital logic
Communication	Forward error correction and modulator blocks, commonly used in digital communications systems
Control Logic	Blocks for control circuitry and state machines
DSP	Digital signal processing (DSP) blocks
Data Types	Blocks that convert data types (includes gateways)
Floating-Point	Blocks that support the Floating-Point data type
Index	Every block in the Xilinx Blockset.
Math	Blocks that implement mathematical functions
Memory	Blocks that implement and access memories
Shared Memory	Blocks that implement and access Xilinx shared memories
Tools	"Utility" blocks, e.g., code generation (System Generator token), resource estimation, HDL co-simulation, etc

**Note:** More information concerning blocks can be found in the topic [Xilinx Blockset](#).

## Xilinx Reference Blockset

The Xilinx Reference Blockset contains composite System Generator blocks that implement a wide range of functions. Blocks in this blockset are organized by function into different libraries. The libraries are described below.

Library	Description
Communication	Blocks commonly used in digital communications systems
Control Logic	LogicBlocks used for control circuitry and state machines
DSP	Digital signal processing (DSP) blocks
Imaging	Image processing blocks
Math	Blocks that implement mathematical functions

Each block in this blockset is a composite, i.e., is implemented as a masked subsystem, with parameters that configure the block.

You can use blocks from the Reference Blockset libraries as is, or as starting points when constructing designs that have similar characteristics. Each reference block has a description of its implementation and hardware resource requirements. Individual documentation for each block is also provided in the topic [Xilinx Reference Blockset](#).

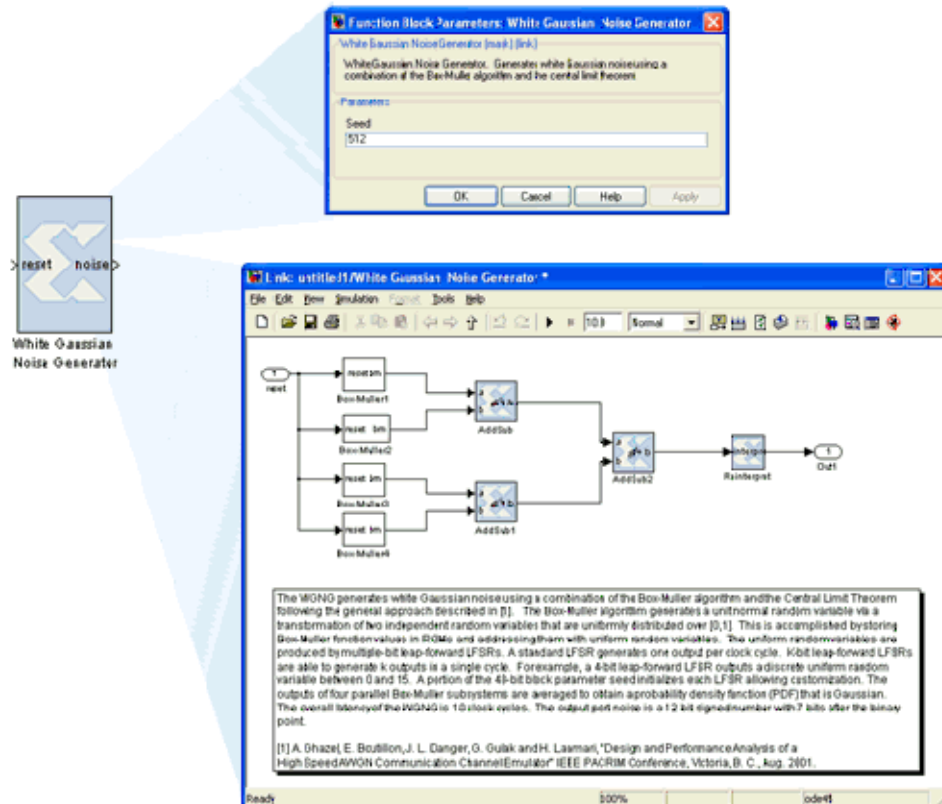

## Signal Types

In order to provide bit-accurate simulation of hardware, System Generator blocks operate on Boolean, floating-point, and arbitrary precision fixed-point values. By contrast, the fundamental scalar signal type in Simulink is double precision floating point. The connection between Xilinx blocks and non-Xilinx blocks is provided by *gateway blocks*. The *gateway in* converts a double precision signal into a Xilinx signal, and the *gateway out* converts a Xilinx signal into double precision. Simulink continuous time signals must be sampled by the Gateway In block.

Most Xilinx blocks are polymorphic, i.e., they are able to deduce appropriate output types based on their input types. When *full precision* is specified for a block in its parameters dialog box, System Generator chooses the output type to ensure no precision is lost. Sign extension and zero padding occur automatically as necessary. *User-specified precision* is usually also available. This allows you to set the output type for a block and to specify how quantization and overflow should be handled. Quantization possibilities include unbiased rounding towards plus or minus infinity, depending on sign, or truncation. Overflow options include saturation, truncation, and reporting overflow as an error.



**Note:** System Generator data types can be displayed by selecting **Format > Port Data Types** in Simulink. Displaying data types makes it easy to determine precision throughout a model. If, for example, the type for a port is `Fix_11_9`, then the signal is a two's complement signed 11-bit number having nine fractional bits. Similarly, if the type is `Ufix_5_3`, then the signal is an unsigned 5-bit number having three fractional bits.

In the System Generator portion of a Simulink model, every signal must be sampled. Sample times may be inherited using Simulink's propagation rules, or set explicitly in a block customization dialog box. When there are feedback loops, System Generator is sometimes unable to deduce sample periods and/or signal types, in which case the tool issues an error message. *Assert blocks* must be inserted into loops to address this problem. It is not necessary to add assert blocks at every point in a loop; usually it suffices to add an assert block at one point to "break" the loop.

**Note:** Simulink can display a model by shading blocks and signals that run at different rates with different colors (**Format > Sample Time Colors** in the Simulink pulldown menus). This is often useful in understanding multirate designs.

## Floating-Point Data Type

System Generator blocks found in the Floating-Point library support the floating-point data type.

System Generator uses the Floating-Point Operator v6.0 IP core to leverage the implementation of operations such as addition/subtraction, multiplication, comparisons and data type conversion.

The floating-point data type support is in compliance with IEEE-754 Standard for Floating-Point Arithmetic. Single precision, Double precision and Custom precision floating-point data types are supported for design input, data type display and for data rate and type propagation (RTP) across the supported System Generator blocks.

### IEEE-754 Standard for Floating-Point Data Type

As shown below, floating-point data is represented using one Sign bit (S), X exponent bits and Y fraction bits. The Sign bit is always the most-significant bit (MSB).

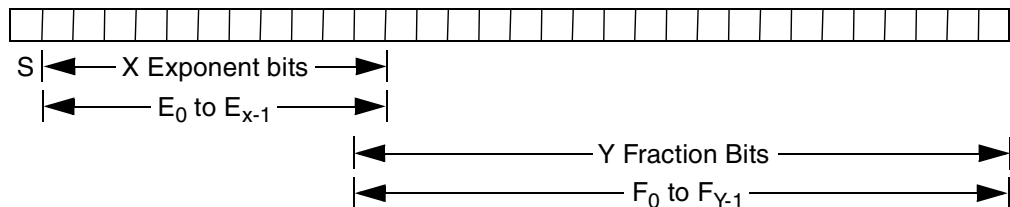

According to the IEEE-754 standard, a floating-point value is represented and stored in the normalized form. In the normalized form the exponent value  $E$  is a biased/normalized value. The normalized exponent,  $E$ , equals the sum of the actual exponent value and the exponent bias. In the normalized form,  $Y-1$  bits are used to store the fraction value. The  $F_0$  fraction bit is always a hidden bit and its value is assumed to be 1.

$S$  represents the value of the sign of the number. If  $S$  is 0 then the value is a positive floating-point number; otherwise it is negative. The  $X$  bits that follow are used to store the normalized exponent value  $E$  and the last  $Y-1$  bits are used to store the fraction/mantissa value in the normalized form.

For the given exponent width, the exponent bias is calculated using the following equation:

$$\text{Exponent\_bias} = 2^{(X-1)} - 1, \text{ where } X \text{ is the exponent bit width.}$$

According to the IEEE standard, a single precision floating-point data is represented using 32 bits. The normalized exponent and fraction/mantissa are allocated 8 and 24 bits, respectively. The exponent bias for single precision is 127. Similarly, a double precision floating-point data is represented using a total of 64 bits where the exponent bit width is 11 and the fraction bit width is 53. The exponent bias value for double precision is 1023.

The normalized floating-point number in the equation form is represented as follows:

$$\text{Normalized Floating-Point Value} = (-1)^S \times F_0.F_1F_2 \dots F_{Y-2}F_{Y-1} \times (2)^E$$

The actual value of exponent ( $E_{\text{actual}} = E - \text{Exponent\_bias}$ ). Considering 1 as the value for the hidden bit  $F_0$  and the  $E_{\text{actual}}$  value, a floating-point number can be calculated as follows:

$$\text{FP\_Value} = (-1)^S \times 1.F_1F_2 \dots F_{Y-2}F_{Y-1} \times (2)^{E_{\text{actual}}}$$

## Floating-Point Data Representation in System Generator

The System Generator **Gateway In** block previously only supported the Boolean and Fixed-point data types. As shown below, the **Gateway In** block GUI and underlying mask parameters now support the Floating-point data type as well. You can select either a **Single**, **Double** or **Custom** precision type after specifying the floating-point data type.

For example, if Exponent width of 9 and Fraction width of 31 is specified then the floating-point data value will be stored in total 40 bits where the MSB bit will be used for sign representation, the following 9 bits will be used to store biased exponent value and the 30 LSB bits will be used to store the fractional value.

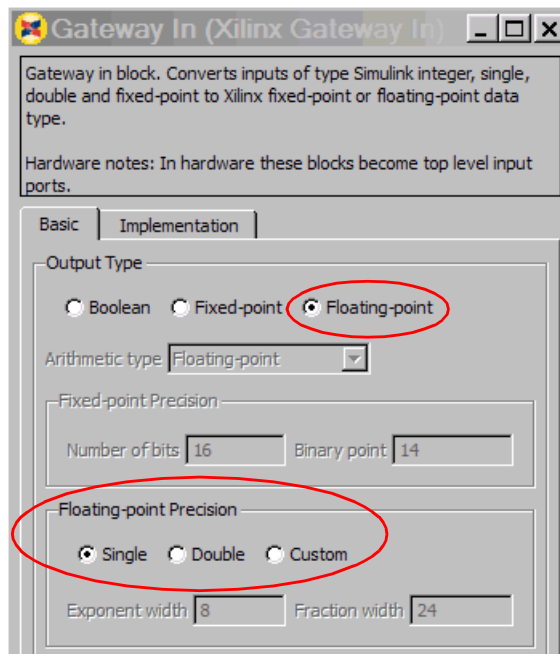

In compliance with the IEEE-754 standard, if **Single** precision is selected then the total bit width is assumed to be 32; 8 bits for the exponent and 24 bits for the fraction. Similarly when **Double** precision is selected, the total bit width is assumed to be 64 bits; 11 bits for the exponent and 53 bits for the fraction part. When **Custom** precision is selected, the **Exponent width** and **Fraction width** fields are activated and you are free to specify values for these fields (8 and 24 are the default values). The total bit width for **Custom** precision data is the summation of the number of exponent bits and the number of fraction bits.

Similar to fraction bit width for **Single** precision and **Double** precision data types the fraction bit width for **Custom** precision data type must include the hidden bit  $F_0$

## Displaying the Data Type on Output Signals

As shown below, after a successful rate and type propagation, the floating-point data type is displayed on the output of each System Generator block. To display the signal data type as shown in the diagram below, you select the pulldown menu item **Format > Port/Signal Displays > Port Data Types**.

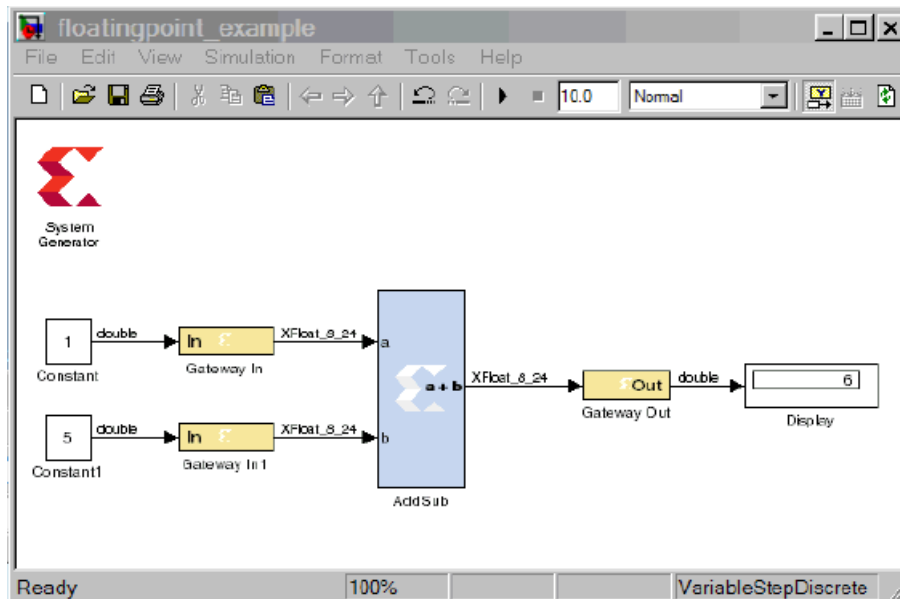

A floating-point data type is displayed using the format:

`XFloat_<exponent_bit_width>_<fraction_bit_width>`. Single and Double precision data types are displayed using the string "XFloat\_8\_24" and "XFloat\_11\_53", respectively.

If for a Custom precision data type the exponent bit width 9 and the fraction bit width 31 are specified, then it will be displayed as "XFloat\_9\_31". A total of 40 bits will be used to store the floating-point data value. Since floating-point data is stored in a normalized form, the fractional value will be stored in 30 bits.

In System Generator the fixed-point data type is displayed using format `XFix_<total_data_width>_<binary_point_width>`. For example, a fixed-point data type with the data width of 40 and binary point width of 31 is displayed as `XFix_40_31`.

It is necessary to point out that in the fixed-point data type the actual number of bits used to store the fractional value is different from that used for floating-point data type. In the example above, all 31 bits are used to store the fractional bits of the fixed-point data type.

System Generator uses the exponent bit width and the fraction bit width to configure and generate an instance of the Floating-Point Operator core.

## Rate and Type Propagation

During data rate and type propagation across a System Generator block that supports floating-point data, the following design rules are verified. The appropriate error is issued if one of the following violations is detected.

1. If a signal carrying floating-point data is connected to the port of a System Generator block that doesn't support the floating-point data type.
2. If the data input (both A and B data inputs, where applicable) and the data output of a System Generator block are not of the same floating-point data type. The DRC check will be made between the two inputs of a block as well as between an input and an output of the block.

If a Custom precision floating-point data type is specified, the exponent bit width and the fraction bit width of the two ports are compared to determine that they are of the same data type.

**Note:** The Convert and Relational blocks are excluded from this check. The Convert block supports Float-to-float data type conversion between two different floating-point data types. The Relational block output is always the Boolean data type because it gives a true or false result for a comparison operation.

3. If the data inputs are of the fixed-point data type and the data output is expected to be floating-point and vice versa.

**Note:** The Convert and Relational blocks are excluded from this check. The Convert block supports Fixed-to-float as well as Float-to-fixed data type conversion. The Relational block output is always the Boolean data type because it gives a true or false result for a comparison operation.

4. If User Defined precision is selected for the Output Type of blocks that support the floating-point data type. For example, for blocks such as AddSub, Mult, CMult, and MUX, only Full output precision is supported if the data inputs are of the floating-point data type.
5. If the Carry In port or Carry Out port is used for the AddSub block when the operation on a floating-point data type is specified.
6. If the Floating-Point Operator IP core gives an error for DRC rules defined for the IP.

## AXI Signal Groups

System Generator blocks found in the AXI4 library contain interfaces that conform to the AXI™ 4 specification. Blocks with AXI interfaces are drawn such that ports relating to a particular AXI interface are grouped and colored in similarly. This makes it easier to identify data and control signals pertaining to the same interface. Grouping similar AXI ports together also make it possible to use the Simulink Bus Creator and Simulink Bus Selector blocks to connect groups of signals together. More information on AXI can be found in the section entitled [AXI Interface](#). For more detailed information on the AMBA AXI4 specification, please refer to the Xilinx AMBA AXI4 documents found at the following location: <http://www.xilinx.com/ipcenter/axi4>

## Bit-True and Cycle-True Modeling

Simulations in System Generator are *bit-true* and *cycle-true*. To say a simulation is bit-true means that at the boundaries (i.e., interfaces between System Generator blocks and non-System Generator blocks), a value produced in simulation is bit-for-bit identical to the corresponding value produced in hardware. To say a simulation is cycle-true means that at the boundaries, corresponding values are produced at corresponding times. The

boundaries of the design are the points at which System Generator gateway blocks exist. When a design is translated into hardware, Gateway In (respectively, Gateway Out) blocks become top-level input (resp., output) ports.

## Timing and Clocking

### Discrete Time Systems

Designs in System Generator are discrete time systems. In other words, the signals and the blocks that produce them have associated sample rates. A block's sample rate determines how often the block is awoken (allowing its state to be updated). System Generator sets most sample rates automatically. A few blocks, however, set sample rates explicitly or implicitly.

**Note:** For an in-depth explanation of Simulink discrete time systems and sample times, consult the Using Simulink reference manual from the MathWorks, Inc.

A simple System Generator model illustrates the behavior of discrete time systems. Consider the model shown below. It contains a gateway that is driven by a Simulink source (Sine Wave), and a second gateway that drives a Simulink sink (Scope).

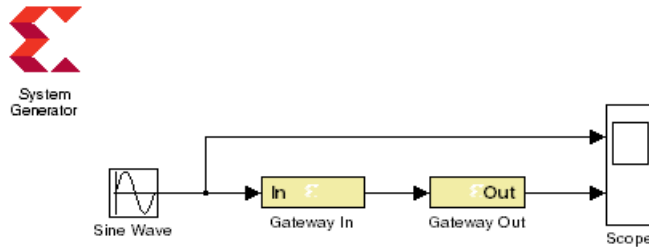

The Gateway In block is configured with a sample period of one second. The Gateway Out block converts the Xilinx fixed-point signal back to a double (so it can analyzed in the Simulink scope), but does not alter sample rates. The scope output below shows the unaltered and sampled versions of the sine wave.

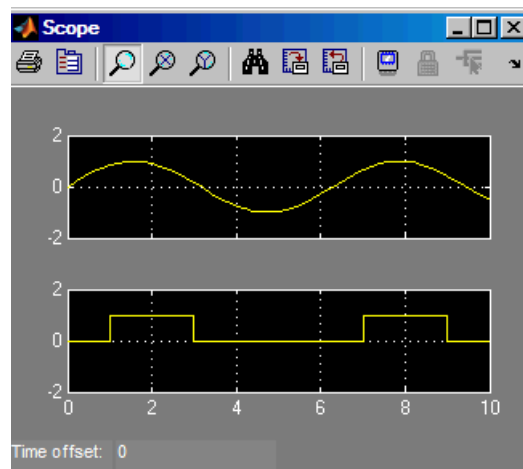

### Multirate Models

System Generator supports *multirate* designs, i.e., designs having signals running at several sample rates. System Generator automatically compiles multirate models into

hardware. This allows multirate designs to be implemented in a way that is both natural and straightforward in Simulink.

## Rate-Changing Blocks

System Generator includes blocks that change sample rates. The most basic rate changers are the Up Sample and Down Sample blocks. As shown in the figure below, these blocks explicitly change the rate of a signal by a fixed multiple that is specified in the block's dialog box.



Other blocks (e.g., the Parallel To Serial and Serial To Parallel converters) change rates implicitly in a way determined by block parameterization.

Consider the simple multirate example below. This model has two sample periods, SP1 and SP2. The Gateway In dialog box defines the sample period SP1. The Down Sample block causes a rate change in the model, creating a new rate SP2 which is half as fast as SP1.

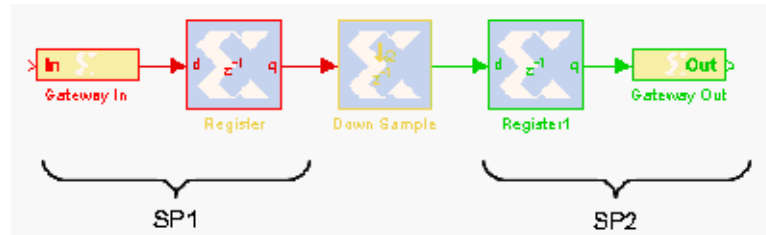

## Hardware Oversampling

Some System Generator blocks are oversampled, i.e., their internal processing is done at a rate that is faster than their data rates. In hardware, this means that the block requires more than one clock cycle to process a data sample. In Simulink such blocks do not have an observable effect on sample rates.

One block that can be oversampled is the DAFIR FIR filter. An oversampled DAFIR processes samples serially, thus running at a higher rate, but using less hardware.

Although blocks that are oversampled do not cause an explicit sample rate change in Simulink, System Generator considers the internal block rate along with all other sample rates when generating clocking logic for the hardware implementation. This means that you must consider the internal processing rates of oversampled blocks when you specify the Simulink system period value in the System Generator token dialog box.

## Asynchronous Clocking

System Generator focuses on the design of hardware that is synchronous to a single clock. It can, under some circumstances, be used to design systems that contain more than one clock. This is possible provided the design can be partitioned into individual clock domains with the exchange of information between domains being regulated by dual port memories and FIFOs. System Generator fully supports such multi-clock designs, including the ability to simulate them in Simulink and to generate complete hardware descriptions. Details are discussed in the topic [Generating Multiple Cycle-True Islands for Distinct Clocks](#). The remainder of this topic focuses exclusively on the clock-synchronous aspects of System Generator. This discussion is relevant to both single-clock and multiple-clock designs.

## Synchronous Clocking

As shown in the figure below, when you use the System Generator token to compile a design into hardware, there are three clocking options for Multirate implementation: (1) Clock Enables (the default), (2) Hybrid DCM-CE, and (3) Expose Clock Ports.

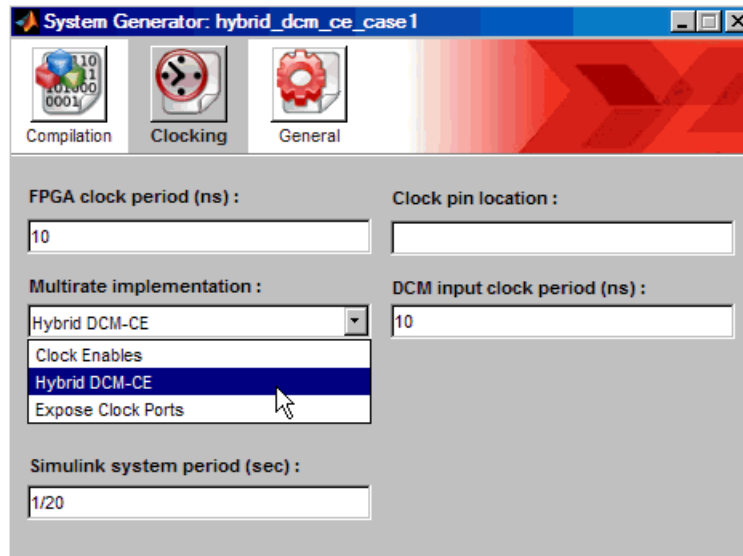

### The Clock Enables Option

When System Generator compiles a model into hardware with the Clock Enable option selected, System Generator preserves the sample rate information of the design in such a way that corresponding portions in hardware run at appropriate rates. In hardware, System Generator generates related rates by using a single clock in conjunction with clock enables, one enable per rate. The period of each clock enable is an integer multiple of the period of the system clock.

Inside Simulink, neither clocks nor clock enables are required as explicit signals in a System Generator design. When System Generator compiles a design into hardware, it uses the sample rates in the design to deduce what clock enables are needed. To do this, it employs two user-specified values from the System Generator token: the Simulink system period and FPGA clock period. These numbers define the scaling factor between time in a Simulink simulation, and time in the actual hardware implementation. The Simulink system period must be the greatest common divisor (gcd) of the sample periods that appear in the model, and the FPGA clock period is the period, in nanoseconds, of the system clock. If  $p$  represents the Simulink system period, and  $c$  represents the FPGA system clock period, then something that takes  $kp$  units of time in Simulink takes  $k$  ticks of the system clock (hence  $kc$  nanoseconds) in hardware.

To illustrate this point, consider a model that has three Simulink sample periods 2, 3, and 4. The gcd of these sample periods is 1, and should be specified as such in the Simulink System Period field for the model. Assume the FPGA Clock Period is specified to be 10ns. With this information, the corresponding clock enable periods can be determined in hardware.

In hardware, we refer to the clock enables corresponding to the Simulink sample periods 2, 3, and 4 as CE2, CE3, and CE4, respectively. The relationship of each clock enable period to the system clock period can be determined by dividing the corresponding Simulink sample period by the Simulink System Period value. Thus, the periods for CE2, CE3, and



CE4 equal 2, 3, and 4 system clock periods, respectively. A timing diagram for the example clock enable signals is shown below:

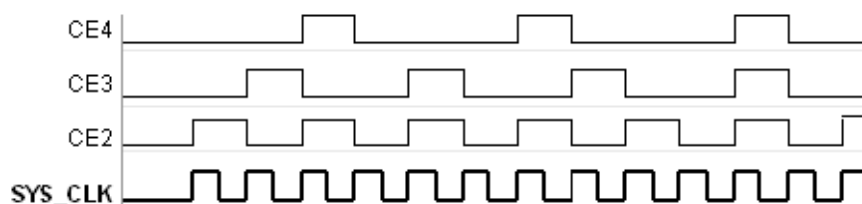

### The Hybrid DCM-CE Option

If the implementation target is an FPGA with a Digital Clock Manager (DCM), you can choose to drive the clock tree with a DCM. The DCM option is desirable when high fanout on clock enable nets make it difficult to achieve timing closure.

System Generator instantiates the DCM in a top-level HDL clock wrapper and configures the DCM to provide up to three clock ports at different rates for Virtex®-4 and Virtex®-5 and up to two clock ports for Spartan-3A DSP. If the design has more clock ports than the DCM can support, the remaining clocks are supported with the CE (clock enable) configuration. The mapping of rates to the DCM outputs is done according to the following priority scheme:

$CLK0 > CLK2x > CLKdv > CLKfx$ . The DCM supports the higher clock rates first.

A `dcm_reset` input port is exposed on the top-level wrapper to allow the external design to reset the DCM after bitstream configuration. A `dcm_locked` output port is also exposed to help the external design synchronize the input data with the single `clk` input port.

**Known Limitations:** The following System Generator blocks are not supported by the Hybrid DCM-CE Option:

- Clock Enable Probe
- Clock Probe
- DAFIR
- Downsample - when the Sample option **First value of the frame** is selected
- FIR Compiler - when the core rate is not equal to the input sample rate
- Parallel to Serial- when the Latency option is specified as 0 (zero)
- Time Division De-Multiplexer
- Time Division Multiplexer
- Upsample - when the **Copy samples (otherwise zeros are inserted)** option is *not* selected.

### The Expose Clock Ports Option

When you select this option, System Generator creates a top-level wrapper that exposes a clock port for each rate. You can then manually instantiate a clock generator outside the design to drive the clock ports.

**Known Limitations:** The following System Generator blocks are not supported by the Expose Clock Ports Option:

- Clock Enable Probe
- Clock Probe
- DAFIR



- Downsample - when the Sample option **First value of the frame** is selected
- FIR Compiler - when the core rate is not equal to the input sample rate
- Parallel to Serial- when the Latency option is specified as 0 (zero)
- Time Division De-Multiplexer
- Time Division Multiplexer
- Upsample - when the **Copy samples (otherwise zeros are inserted)** option is *not* selected.

### Tutorial Example: Using the Hybrid DCM-CE Option

The following step-by-step example will show you how to select the Hybrid DCM-CE option, netlist the HDL design, implement the design in ISE®, simulate the design and examine the files and reports to verify that the DCM is properly instantiated and configured.

The **hybrid\_dcm\_ce\_case1.mdl** design example is located at the following pathname  
...<ISE\_Design\_Suite\_tree>/sysgen>/examples/clocking\_options/hybrid\_dcm\_ce\_case1/hybrid\_dcm\_ce\_case1.mdl

1. Open the model in MATLAB and observe the following blocks:
  - **Addressable Shift Register (ASR)**: used to implement the input delay buffer. The address port runs *n* times faster than the data port, where *n* is the number of the filter taps (5 for this example)
  - **Coefficient ROM**: used to store the filter coefficients
  - **Counter**: used to generate addresses for the ROM and ASR
  - **Comparator**: used to generate the reset and enable signals

- **MAC Engine:** used as a Multiply-Accumulator operator for the filter

### Demonstration on Using the Hybrid DCM-CE Clocking Option

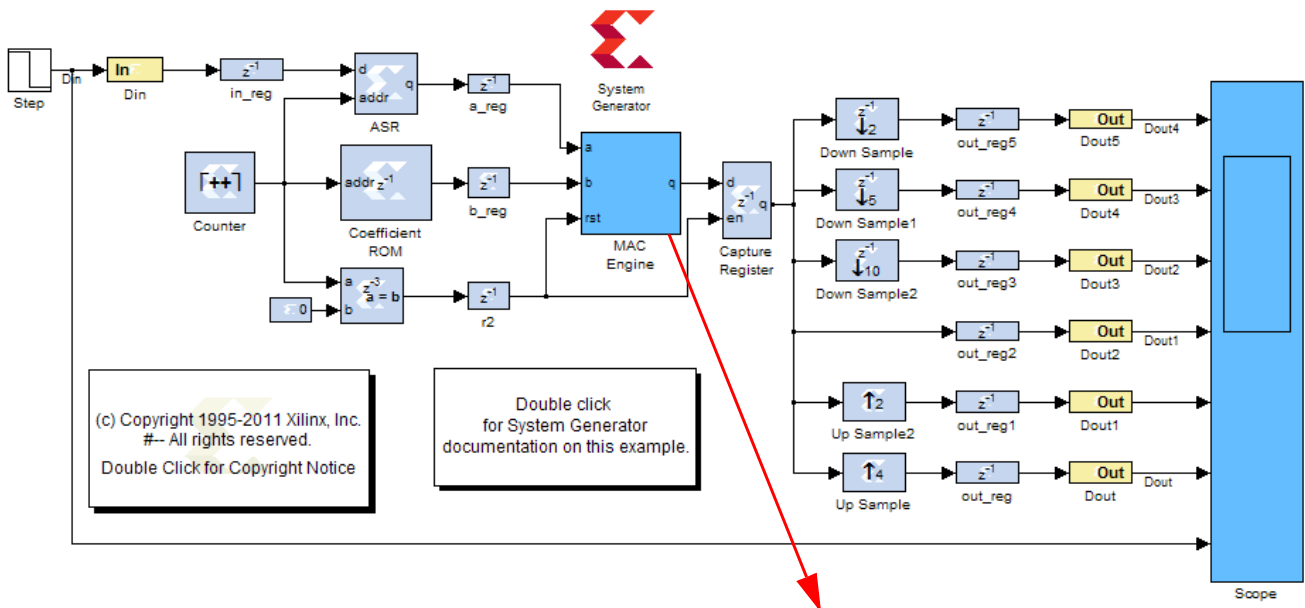

(c) Copyright 1995-2011 Xilinx, Inc. #-- All rights reserved. Double Click for Copyright Notice

Double click for System Generator documentation on this example.

This subsystem implements a multiply-accumulate engine.

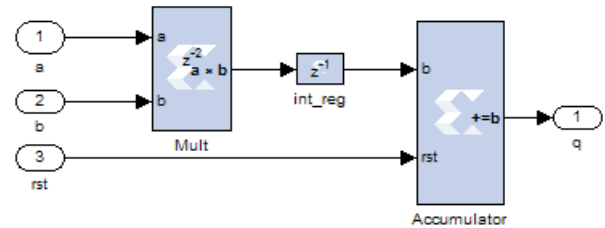

2. Double-click on the **System Generator** token to bring up the following dialog box:

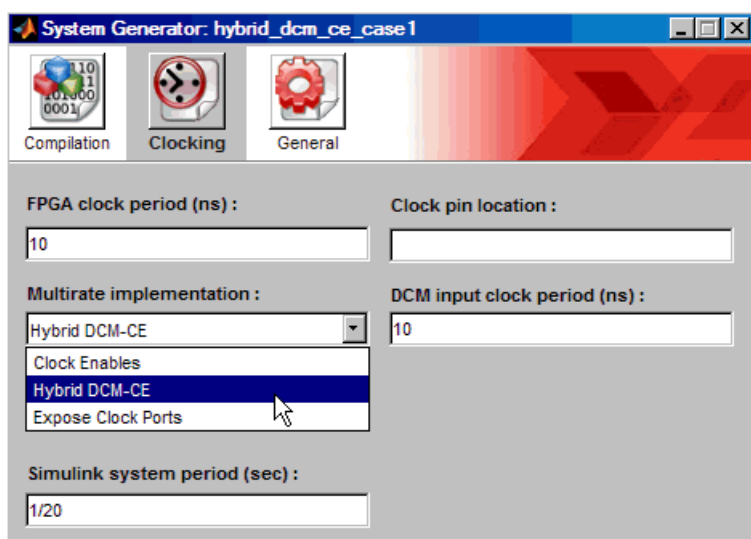

As shown, click on the the **Clocking** tab, select **Hybrid DCM-CE**, then click **Generate**. After a few moments, a sub-directory named **hdl\_netlist\_dcm** is created in the current working directory containing the generated files.

3. In the MATLAB Current Directory window, double-click on the file `hybrid_dcm_ce_case1_sysgen.log`. As shown below, the DCM clocks are listed first (highest rates first), followed by the CE driven clocks.

----- DCM Clock Outputs -----		
Normalized Period	DCM Output Used	Frequency
1	CLKO	100.000C
2	CLKFX	50.000C
4	CLKDV	25.000C
8	(CLKDV, ce_8)	12.500C
20	(CLKDV, ce_20)	5.000C
40	(CLKDV, ce_40)	2.500C

4. Launch ISE, then load the ISE project at pathname `./hdl_netlist_dcm/hybrid_dcm_ce_case1_dcm_mcw.ise`
5. Under the Project Navigator **Processes** view, double-click on **Implement Design**.
6. From the Project Navigator Design Sources Hierarchy view, do the following:
  - a. Double-click on the file `hybrid_dcm_ce_case1_dcm_mcw.vhd`, then scroll down to view the DCM component declaration as shown below by the VHDL code snippet:

```

580 component DCM_ADV
581 generic (
582     CLKDV_DIVIDE: real := 4.0;
583     CLKFX_MULTIPLY: integer := 2;
584     CLKFX_DIVIDE: integer := 4;
585     DFS_FREQUENCY_MODE: string := "LOW";
586     DLL_FREQUENCY_MODE: string := "LOW";
587     CLKIN_PERIOD: real := 10.0;
588     CLKIN_DIVIDE_BY_2: boolean := false;
589     CLKOUT_PHASE_SHIFT: string := "NONE";
590     CLK_FEEDBACK: string := "1X";
591     PHASE_SHIFT: integer := 0;
592     SIM_DEVICE: string := "VIRTEX5"
593 );
    
```

- b. Observe that System Generator automatically infers and instantiates the DCM instance and its parameters according to the required clock outputs.
  - c. Close the VHDL file.

Next, you are going to examine the clock propagation by examining the ISE timing report. First, you must generate the report.

7. Open the following folder: **Processes** view > **Implement Design** > **Place & Route** > **Generate Post-Place & Route Static Timing**

- Double-click on **Analyze Post-Place & Route Static Timing** and you should see the information in the figure below:

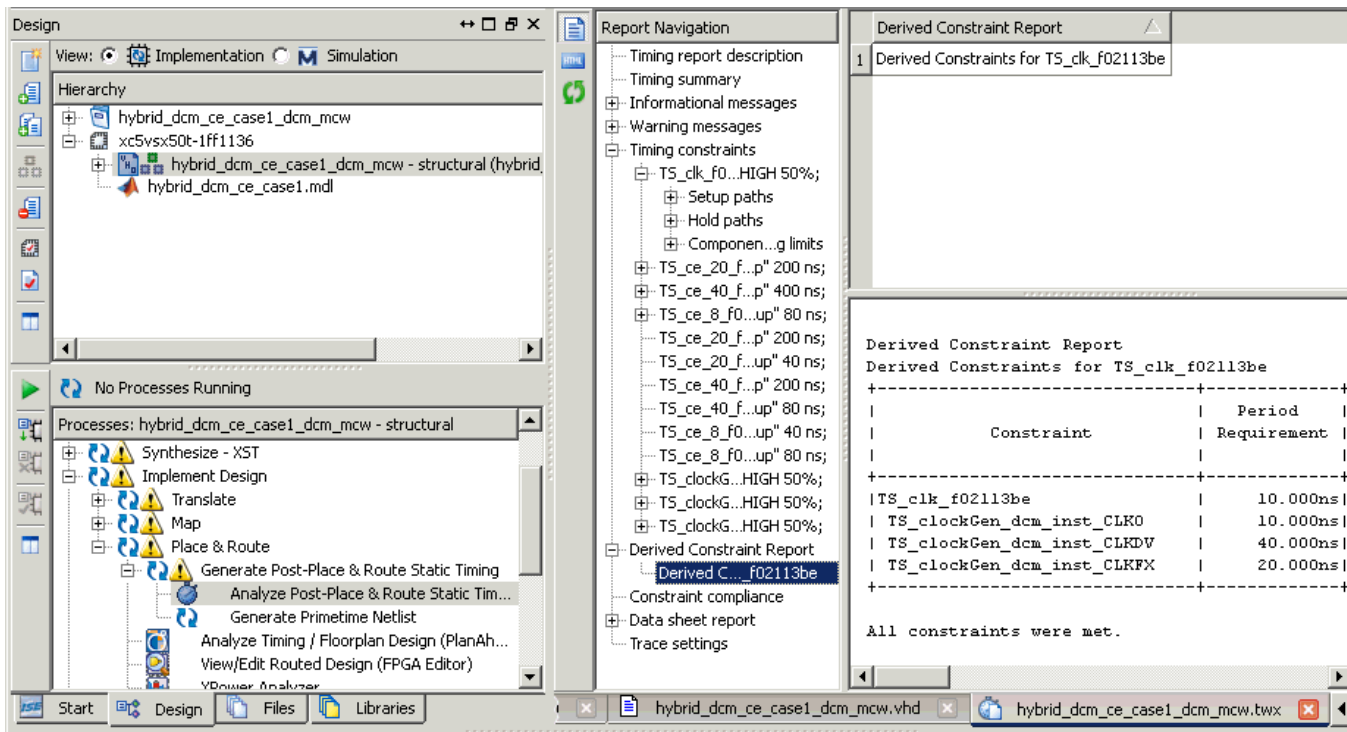

The screenshot shows the Xilinx IDE interface. The 'Report Navigation' pane on the right lists various reports, with 'Derived Constraint Report' selected. The 'Derived Constraint Report' pane on the far right displays the following table:

Derived Constraints for TS_clk_f02113be	
Constraint	Period Requirement
TS_clk_f02113be	10.000ns
TS_clockGen_dcm_inst_CLK0	10.000ns
TS_clockGen_dcm_inst_CLKDV	40.000ns
TS_clockGen_dcm_inst_CLKFX	20.000ns

Below the table, it states: "All constraints were met."

This design is comprised of six clock rates – 1, 2, 4, 8, 20, 40 with respect to the 10 ns global clock constraint. The timing report validates the correct clock generation and propagation by System Generator as follows:

- ◆ **DCM-based clocks:** clk\_1 (CLK0 ->10 ns), clk\_2 (CLKFX ->20 ns), clk\_4 (CLKDIV ->40 ns) generated by the DCM based on the 10 ns global clock input
- ◆ **Clock Enable-based clocks:** ce\_8 (80 ns), ce\_20 (200 ns), ce\_40 (400 ns) generated by clock enables based on the clk\_4 clock input

Next you want to perform a behavior simulation using the ModelSim.

- As shown in the following figure, move to the **Sources for** dialog box in the **Sources** window, then select **Behavioral Simulation**

**Note:** System Generator automatically creates the top-wrapper VHDL testbench, script file and input/output stimulus data files. The **Processes** tab changes and displays according to the Sources type being selected.

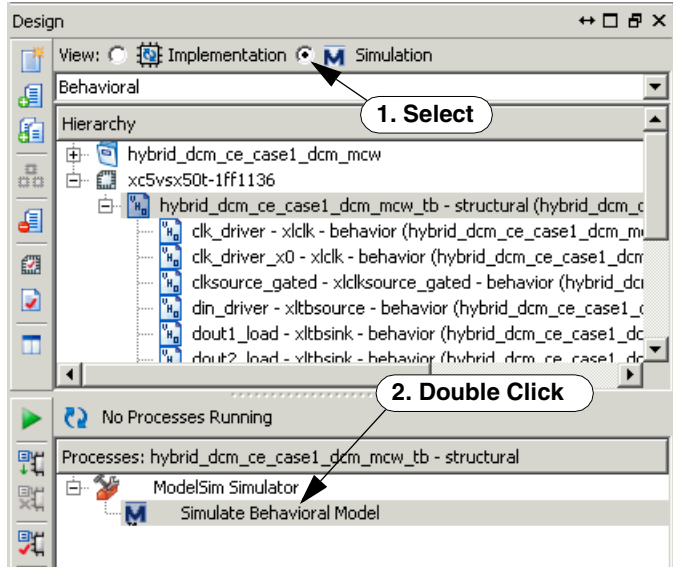

10. Simulate the design, as shown above, by double-click on **Simulate Behavioral Model** in the **Processes** window
11. After the simulation is finished, you should be able to observe the simulation waveforms as shown in the figure below:

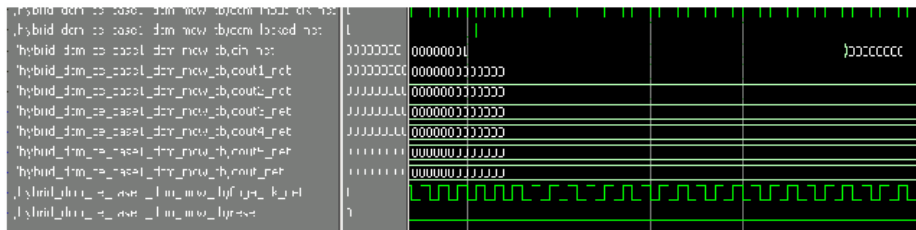

```

Transcript
# - Ignored: 0 (0.0%) Don't Cares
# Test completed with no errors.
#
#** Simulation summary for instance hybrid_dcm_ce_case1_dout4:
# Samples Processed: 20
# - Checked: 20 (100.0%)
# - Ignored: 0 (0.0%) Don't Cares
# Test completed with no errors.
#
#** Simulation summary for instance hybrid_dcm_ce_case1_dout5:
# Samples Processed: 50
# - Checked: 50 (100.0%)
# - Ignored: 0 (0.0%) Don't Cares
# Test completed with no errors.
#
#** Simulation summary for instance hybrid_dcm_ce_case1_dout:
# Samples Processed: 400
# - Checked: 400 (100.0%)
# - Ignored: 0 (0.0%) Don't Cares
# Test completed with no errors.
    
```

All DCM clocks are included in the top-level wrapper testbench file (hybrid\_dcm\_ce\_case1\_dcm\_mcw\_tb.vhd) – clk\_1, clk\_2 and clk\_4.

**Summary**

When you select the **Hybrid DCM-CE** option, System Generator automatically infers and instantiates a DCM without further manual intervention. In addition, the tool intelligently generates different clock rates by using a combination of DCM and CE clock generation algorithms and by assigning appropriate clock rates to either the DCM or CE in order to obtain optimal Quality of Results and low power consumption. You do not have to set attributes or specify DCM clock outputs. You should expect minimal clock skew when selecting the **Hybrid DCM-CE** option compared to the **Clock Enables** option alone.

### Tutorial Example: Using the Expose Clock Ports Option

The following step-by-step example will show you how to select the **Expose Clock Ports** option, netlist the HDL design, implement the design in ISE, simulate the design, then examine the files and reports to verify the design.

The `expose_clock_ports_case1` design example is located at the following pathname `<ISE_Design_Suite_tree>/sysgen>/examples/clocking_options/expose_clock_ports_case1/expose_clock_ports_case1.mdl`

1. Open the model in MATLAB and observe the following blocks:

- **Addressable Shift Register (ASR):** used to implement the input delay buffer. The address port runs  $n$  times faster than the data port, where  $n$  is the number of the filter taps (5 for this example)
- **Coefficient ROM:** used to store the filter coefficients
- **Counter:** used to generate addresses for the ROM and ASR
- **Comparator:** used to generate the reset and enable signals
- **MAC Engine:** used as a Multiply-Accumulator operator for the filter

### Demonstration on Using the Expose Clock Port Option

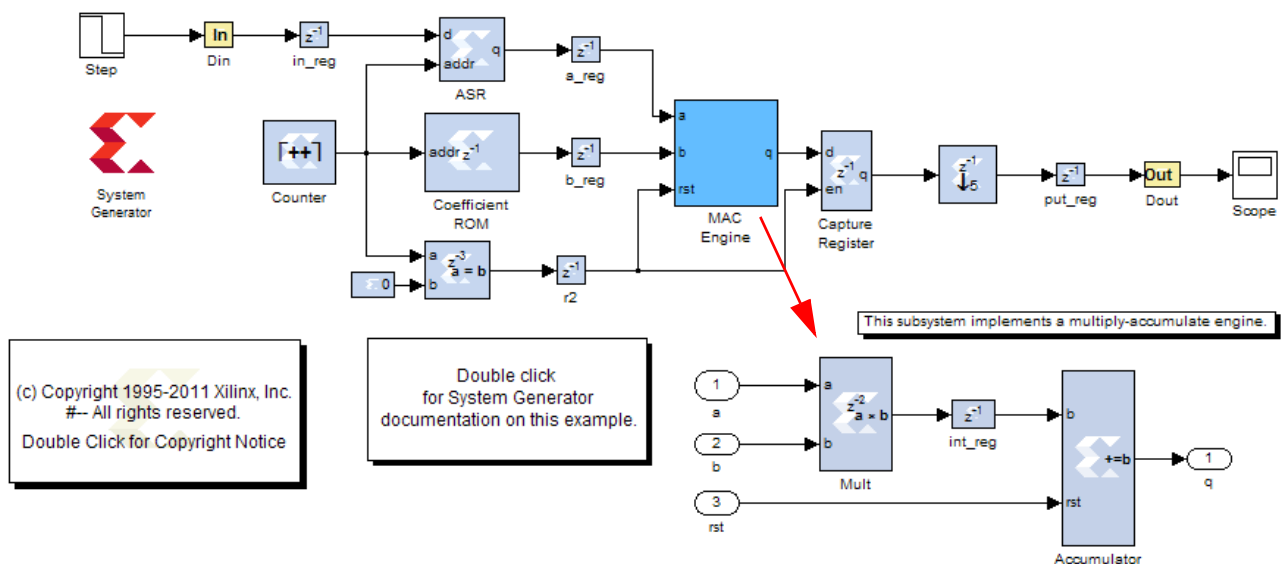

- Double-click on the **System Generator** token to bring up the following dialog box:

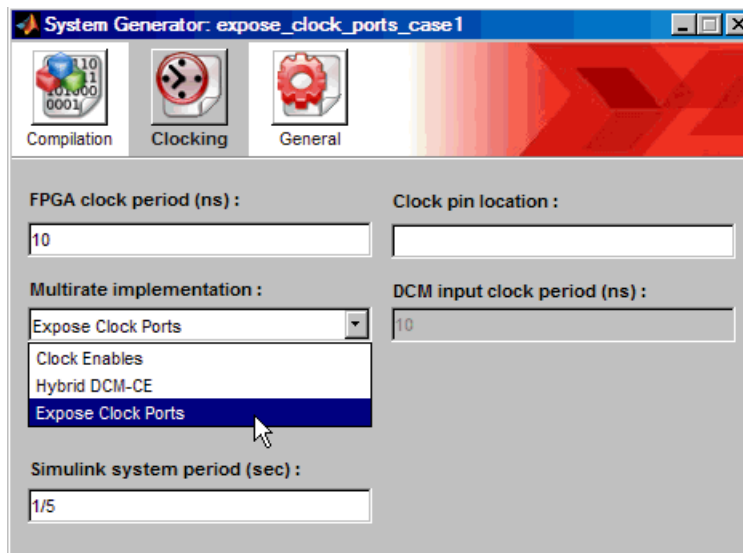

As shown above, click on the **Clocking** tab, select **Expose Clock Ports**, then click **Generate**. After a few moments, a sub-directory named **hdl\_netlist** is created in the current working directory containing the generated files.

- Launch ISE, then load the ISE project at pathname  
./hdl\_netlist/expose\_clock\_ports\_case1\_mcw.ise
- Under the Project Navigator **Processes** view, double-click on **Implement Design**.
- From the Project Navigator **Design Sources Hierarchy** view, do the following:
  - Double-click on the file `expose_clock_ports_case1_mcw.vhd`, then scroll down to view the entity named `expose_clock_ports_mcw`, as shown below:

```

37 library IEEE;
38 use IEEE.std_logic_1164.all;
39 use work.conv_pkg.all;
40
41 entity expose_clock_ports_case1_mcw is
42   port (
43     clk_1: in std_logic; -- clock period = 10.0 ns (100.0 Mhz)
44     clk_5: in std_logic; -- clock period = 50.0 ns (20.0 Mhz)
45     din: in std_logic_vector(7 downto 0);
46     dout: out std_logic_vector(12 downto 0)
47   );
48 end expose_clock_ports_case1_mcw;

```

- Observe that System Generator infers the clocks based on the different rates in the design and brings the clock ports to the top-level wrapper. Since this design contains two clock rates, clocks `clk_1` and `clk_5` are pulled to the top-level wrapper. This will allow you to directly drive the multiple synchronous clocks from outside the System Generator design.
- Close the VHDL file.

Next you want to perform a behavior simulation using the ModelSim.

- As shown below, move to the **Sources for** dialog box in the **Sources** window, then select **Behavioral Simulation**

**Note:** System Generator automatically creates the top-wrapper VHDL testbench, script file and input/output stimulus data files. The **Processes** tab changes and displays according to the Sources type being selected.

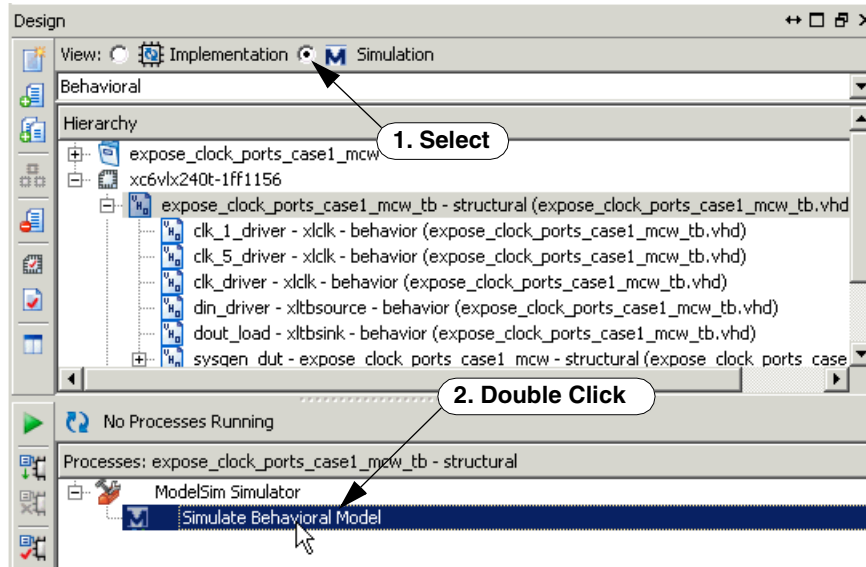

7. Simulate the design, as shown above, by double-click on **Simulate Behavioral Model** in the **Processes** window
8. After the simulation is finished, you should be able to observe the simulation waveforms as shown in the figure below:

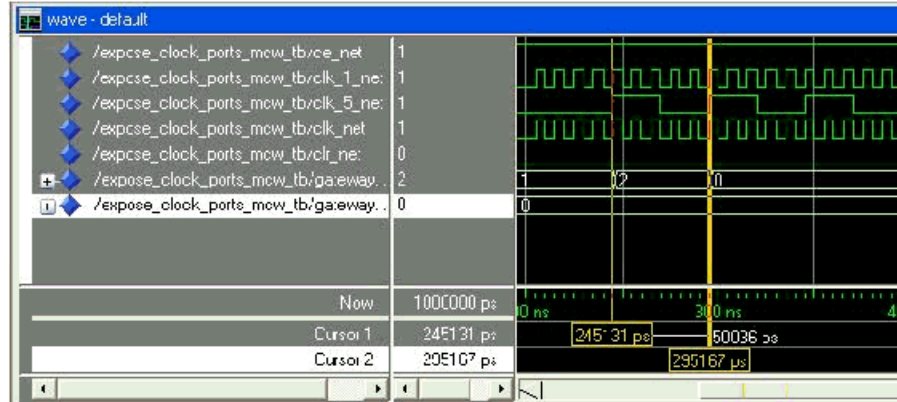

### Summary

When you select the **Expose Clock Ports** option, System Generator automatically infers the correct clocks from the design rates and exposes the clock ports in the top-level wrapper. The clock rates are determined by the same methodology when you use the **Clock Enables** option. You can now drive the exposed clock ports from an external synchronous clock source.

## Synchronization Mechanisms

System Generator does not make implicit synchronization mechanisms available. Instead, synchronization is the responsibility of the designer, and must be done explicitly.



## Valid Ports

System Generator provides several blocks (in particular, a FIFO) that can be used for synchronization. Several blocks provide input (respectively, output) ports that specify when an input (resp., output) sample is valid. Such ports can be chained, affording a primitive form of flow control. Blocks with such ports include the FFT, FIR, and Viterbi.

## Indeterminate Data

Indeterminate values are common in many hardware simulation environments. Often they are called “don’t cares” or “Xs”. In particular, values in System Generator simulations can be indeterminate. A dual port memory block, for example, can produce indeterminate results if both ports of the memory attempt to write the same address simultaneously. What actually happens in hardware depends upon effectively random implementation details that determine which port sees the clock edge first. Allowing values to become indeterminate gives the system designer greater flexibility. Continuing the example, there is nothing wrong with writing to memory in an indeterminate fashion if subsequent processing does not rely on the indeterminate result.

HDL modules that are brought into the simulation through HDL co-simulation are a common source for indeterminate data samples. System Generator presents indeterminate values to the inputs of an HDL co-simulating module as the standard logic vector 'XXX . . . XX'.

Indeterminate values that drive a Gateway Out become what are called NaNs. (NaN abbreviates “not a number”.) In a Simulink scope, NaN values are not plotted. Conversely, NaNs that drive a Gateway In become indeterminate values. System Generator provides an Indeterminate Probe block that allows for the detection of indeterminate values. This probe cannot be translated into hardware.

In System Generator, any arithmetic signal can be indeterminate, but Boolean signals cannot be. If a simulation reaches a condition that would force a Boolean to become indeterminate, the simulation is halted and an error is reported. Many Xilinx blocks have control ports that only allow Boolean signals as inputs. The rule concerning indeterminate Booleans means that such blocks never see an indeterminate on a control port

A UFix\_1\_0 is a type that is equivalent to Boolean except for the above restriction concerning indeterminate data.

## Block Masks and Parameter Passing

The same scoping and parameter passing rules that apply to ordinary Simulink blocks apply to System Generator blocks. Consequently, blocks in the Xilinx Blockset can be parameterized using MATLAB variables and expressions. This capability makes possible highly parametric designs that take advantage of the expressive and computational power of the MATLAB language.

### Block Masks

In Simulink, blocks are parameterized through a mechanism called *masking*. In essence, a block can be assigned *mask variables* whose values can be specified by a user through dialog box prompts or can be calculated in mask initialization commands. Variables are stored in a *mask workspace*. A mask workspace is local to the blocks under the mask and cannot be accessed by external blocks.

**Note:** It is possible for a mask to access global variables and variables in the base workspace. To access a base workspace variable, use the MATLAB `evalin` function. For more information on the

MATLAB and Simulink scoping rules, refer to the manuals titled *Using MATLAB* and *Using Simulink* from *The MathWorks, Inc.*

## Parameter Passing

It is often desirable to pass variables to blocks inside a masked subsystem. Doing so allows the block's configuration to be determined by parameters on the enclosing subsystem. This technique can be applied to parameters on blocks in the Xilinx blockset whose values are set using a listbox, radio button, or checkbox. For example, when building a subsystem that consists of a multiply and accumulate block, you can create a parameter on the subsystem that allows you to specify whether to truncate or round the result. This parameter will be called `trunc_round` as shown in the figure below.

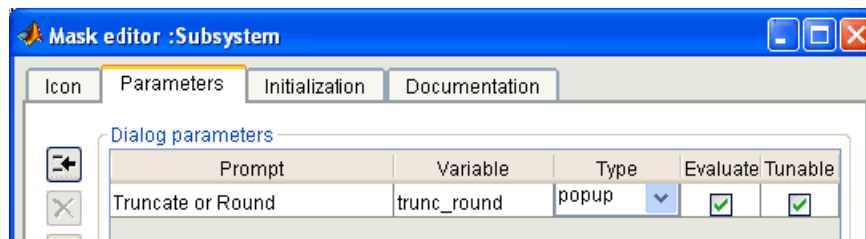

As shown below, in the parameter editing dialog for the accumulator and multiplier blocks, there are radio buttons that allow either the truncate or round option to be selected.

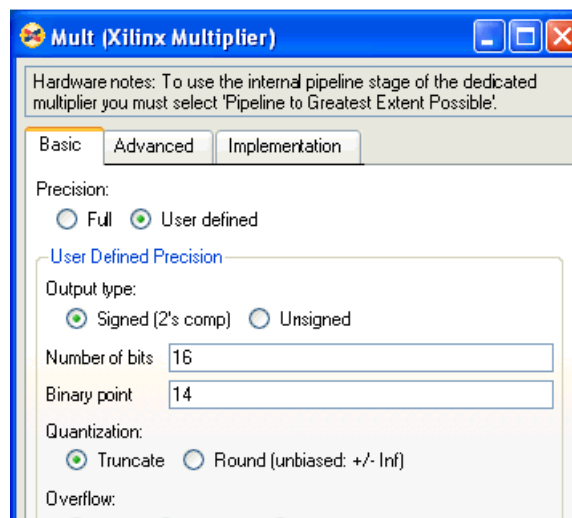

In order to use a parameter rather than the radio button selection, right click on the radio button and select: "Define With Expression". A MATLAB expression can then be used as the parameter setting. In the example below, the `trunc_round` parameter from the

subsystem mask can be used in both the accumulator and multiply blocks so that each block will use the same setting from the mask variable on the subsystem.

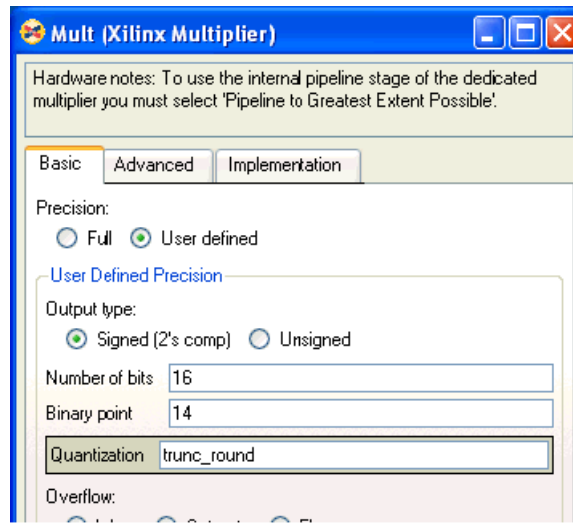

## Resource Estimation

System Generator supplies tools that estimate the FPGA hardware resources needed to implement a design. Estimates include numbers of slices, lookup tables, flip-flops, block memories, embedded multipliers, I/O blocks and tristate buffers. These estimates make it easy to determine how design choices affect hardware requirements. To estimate the resources needed for a subsystem, drag a [Resource Estimator](#) block into the subsystem, double-click on the estimator, and press the **Estimate** button.

## Automatic Code Generation

System Generator automatically compiles designs into low-level representations. The ways in which System Generator compiles a model can vary, and depend on settings in the System Generator token. In addition to producing HDL descriptions of hardware, the tool generates auxiliary files. Some files (e.g., project files, constraints files) assist downstream tools, while others (e.g., VHDL testbench) are used for design verification.

- |   |  |
|---|--|
| <a href="#">Compiling and Simulating Using the System Generator Token</a> | Describes how to use the System Generator token to compile designs into equivalent low-level HDL.  |
| <a href="#">Compilation Results</a>                                       | Describes the low-level files System Generator produces when <b>HDL Netlist</b> is selected on the System Generator token and <b>Generate</b> is pushed. |
| <a href="#">HDL Testbench</a>   | Describes the VHDL testbench that System Generator can produce.  |

## Compiling and Simulating Using the System Generator Token

System Generator automatically compiles designs into low-level representations. Designs are compiled and simulated using the [System Generator](#) token. This topic describes how to use the block.

Before a System Generator design can be simulated or translated into hardware, the design must include a System Generator token. When creating a new design, it is a good idea to add a System Generator token immediately. The System Generator token is a member of the Xilinx Blockset's Basic Elements and Tools libraries. As with all Xilinx blocks, the System Generator token can also be found in the Index library.

A design must contain at least one System Generator token, but can contain several System Generator tokens on different levels (one per level). A System Generator token that is underneath another in the hierarchy is a *slave*; one that is not a slave is a *master*. The scope of a System Generator token consists of the level of hierarchy into which it is embedded and all subsystems below that level. Certain parameters (e.g. **Simulink System Period**) can be specified only in a master.

Once a System Generator token is added, it is possible to specify how code generation and simulation should be handled. The token's dialog box is shown below:

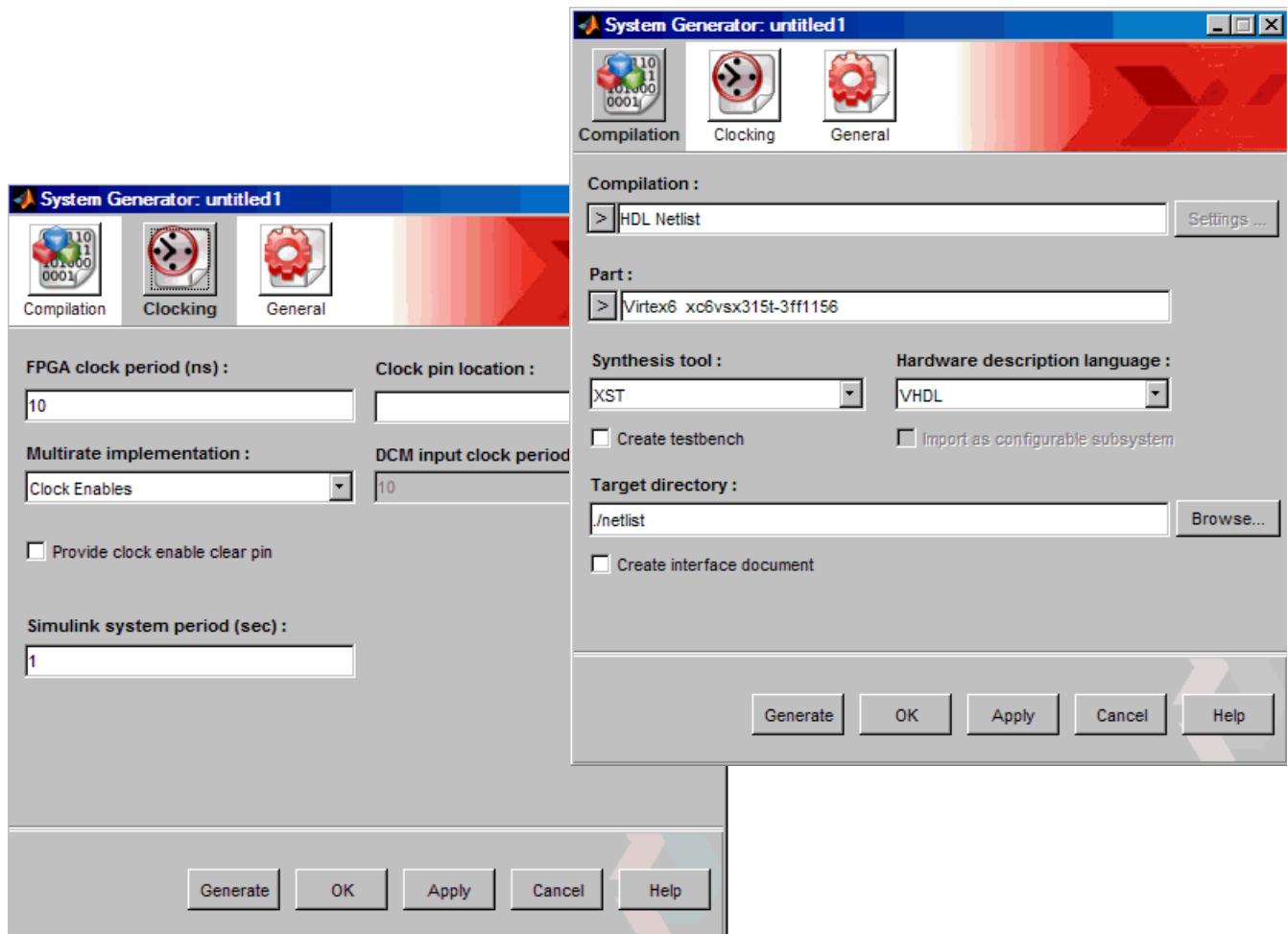

## Compilation Type and the Generate Button

Pressing the **Generate** button instructs System Generator to compile a portion of the design into equivalent low-level results. The portion that is compiled is the sub-tree whose root is the subsystem containing the block. (To compile the entire design, use a System Generator token placed at the top of the design.) The compilation type (under **Compilation**) specifies the type of result that should be produced. The possible types are

- Two types of Netlists, **HDL Netlist** and **NGC Netlist**
- **Bitstream** - produces an FPGA configuration bitstream that is ready to run in a hardware FPGA platform
- **EDK Export Tool** - for exporting to the Xilinx Embedded Development Kit
- **Various varieties of hardware co-simulation**
- **Timing and Power Analysis** - a report on the timing and power consumption of the design.

HDL Netlist is the type used most often. In this case, the result is a collection of HDL and EDIF files, and a few auxiliary files that simplify downstream processing. The collection is ready to be processed by a synthesis tool (e.g., XST), and then fed to the Xilinx physical design tools (i.e., ngdbuild, map, par, and bitgen) to produce a configuration bitstream for a Xilinx FPGA. The files that are produced are described in more detail in [Compilation Results](#).

NGC Netlist is similar to HDL Netlist but the resulting files are NGC files instead of HDL files.

When the type is a variety of hardware co-simulation, then System Generator produces an FPGA configuration bitstream that is ready to run in a hardware FPGA platform. The particular platform depends on the variety chosen. For example, when the variety is **Hardware Co-simulation > XtremeDSP Development Kit > PCI and USB**, then the bitstream is suitable for the XtremeDSP board (available for separate purchase from Xilinx). System Generator also produces a hardware co-simulation block to which the bitstream is associated. This block is able to participate in Simulink simulations. It is functionally equivalent to the portion of the design from which it was derived, but is implemented by its bitstream. In a simulation, the block delivers the same results as those produced by the portion, but the results are calculated in working hardware.

The remaining compilation parameters are described in the table below. Some are available only when the compilation type is **HDL Netlist**. For example, the clock pin location cannot be chosen for a hardware co-simulation compilation because it is fixed in each hardware FPGA platform.

Control	Description
Part	Defines the FPGA part to be used.
Target Directory	Defines where System Generator should write compilation results. Because System Generator and the FPGA physical design tools typically create many files, it is best to create a separate target directory, i.e., a directory other than the directory containing your Simulink model files. The directory can be an absolute path (e.g. c:\netlist) or a path relative to the directory containing the model (e.g. netlist).

Control	Description
Synthesis tool	Specifies the tool to be used to synthesize the design. The possibilities are Synplify, Synplify Pro and Xilinx XST.
Hardware description language	Specifies the language to be used for HDL netlist of the design. The possibilities are VHDL and Verilog.
Create testbench	This instructs System Generator to create an HDL testbench. Simulating the testbench in an HDL simulator compares Simulink simulation results with ones obtained from the compiled version of the design. To construct test vectors, System Generator simulates the design in Simulink, and saves the values seen at gateways. The top HDL file for the testbench is named <name>_testbench.vhd/.v, where <name> is a name derived from the portion of the design being tested and the extension is dependent on the hardware description language.
Import as configurable subsystem	Tells System Generator to do two things: 1) Construct a block to which the results of compilation are associated, and 2) Construct a configurable subsystem consisting of the block and the original subsystem from which the block was derived. See <a href="#">Configurable Subsystems and System Generator</a> for details.
FPGA clock period	Defines the period in nanoseconds of the system clock. The value need not be an integer. The period is passed to the Xilinx implementation tools through a constraints file, where it is used as the global PERIOD constraint. Multicycle paths are constrained to integer multiples of this value.
Clock pin location	Defines the pin location for the hardware clock. This information is passed to the Xilinx implementation tools through a constraints file.
Multirate implementation	<p><b>Clock Enables (default):</b> Creates a clock enable generator circuit to drive a multirate design.</p> <p><b>Hybrid DCM-CE:</b> Creates a clock wrapper with a DCM that can drive up to three clock ports at different rates for Virtex®-4 and Virtex®-5 and up to two clock ports for Spartan-3A DSP. The mapping of rates to the DCM output ports is done using the following priority scheme: CLK0 &gt; CLK2x &gt; CLKdv &gt; CLKfx. The DCM honors the higher clock rates first. If the design contains more clocks than the DCM can handle, the remaining clocks are implemented using the Clock Enable configuration.</p> <p>A <code>reset</code> input port is exposed on the DCM clock wrapper to allow resetting the DCM and a <code>locked</code> output port is exposed to help the external design synchronize the input data with the single <code>clk</code> input pin.</p> <p><b>Expose Clock Ports:</b> This option exposes multiple clock ports on the top-level of the System Generator design so you can apply multiple synchronous clock inputs from outside the design.</p>

Control	Description
DCM input clock period(ns)	Specify if different than the <b>FPGA clock period(ns)</b> option (system clock). The FPGA clock period (system clock) will then be derived from this hardware-defined input.
Provide clock enable clear pin	This instructs System Generator to provide a ce_clr port on the top-level clock wrapper. The ce_clr signal is used to reset the clock enable generation logic. Capability to reset clock enable generations logic allows designs to have dynamic control for specifying the beginning of data path sampling. See the topic for details.

## Simulink System Period

You must specify a value for **Simulink system period** in the System Generator token dialog box. This value tells the underlying rate, in seconds, at which simulations of the design should run. The period must evenly divide all sample periods in the design. For example, if the design consists of blocks whose sample periods are 2, 6, and 8, then the largest acceptable sample period is 2, though other values such as 1 and 0.5 are also acceptable. Sample periods arise in three ways: some are specified explicitly, some are calculated automatically, and some arise implicitly within blocks that involve internal rate changes. For more information on how the system period setting affects the hardware clock, refer to [Timing and Clocking](#).

Before running a simulation or compiling the design, System Generator verifies that the period evenly divides every sample period in the design. If a problem is found, System Generator opens a dialog box suggesting an appropriate value. Clicking the button labeled **Update** instructs System Generator to use the suggested value. To see a summary of period conflicts, click the button labeled **View Conflict Summary**. If you allow System Generator to update the period, you must restart the simulation or compilation.

It is possible to assemble a System Generator model that is inconsistent because its periods cannot be reconciled. (For example, certain blocks require that they run at the system rate. Driving an up-sampler with such a block produces an inconsistent model.) If, even after updating the system period, System Generator reports there are conflicts, then the model is inconsistent and must be corrected.

The period control is hierarchical; see the discussion of hierarchical controls below for details.

## Block Icon Display

The options on this control affect the display of the block icons on the model. After compilation (which occurs when **Generating**, **Simulating**, or by pressing **Control-D**) of the model various information about the block in your model can be displayed, depending on which option is chosen.

- Default—basic information about port directions are shown
- Sample rates—the sample rates of each port are shown
- Pipeline stages—the number of pipeline stages are shown
- HDL port names—the names of the ports are shown
- Input data types—the input data types for each port are shown
- Output data types—output data types for each port are shown



## Hierarchical Controls

The **Simulink System Period** control (see the topic [Simulink System Period](#) above) on the System Generator token is hierarchical. A hierarchical control on a System Generator token applies to the portion of the design within the scope of the token, but can be overridden on other System Generator tokens deeper in the design. For example, suppose **Simulink System Period** is set in a System Generator token at the top of the design, but is changed in a System Generator token within a subsystem S. Then that subsystem will have the second period, but the rest of the design will use the period set in the top level.

## Viewing ISE Reports

When the Compilation is finished, the **Compilation status** dialog box appears as shown below. If your compilation target was Bitstream or Timing and Power Analysis, you can click on the **Show Reports** button and the associated ISE Reports will be available for your viewing:

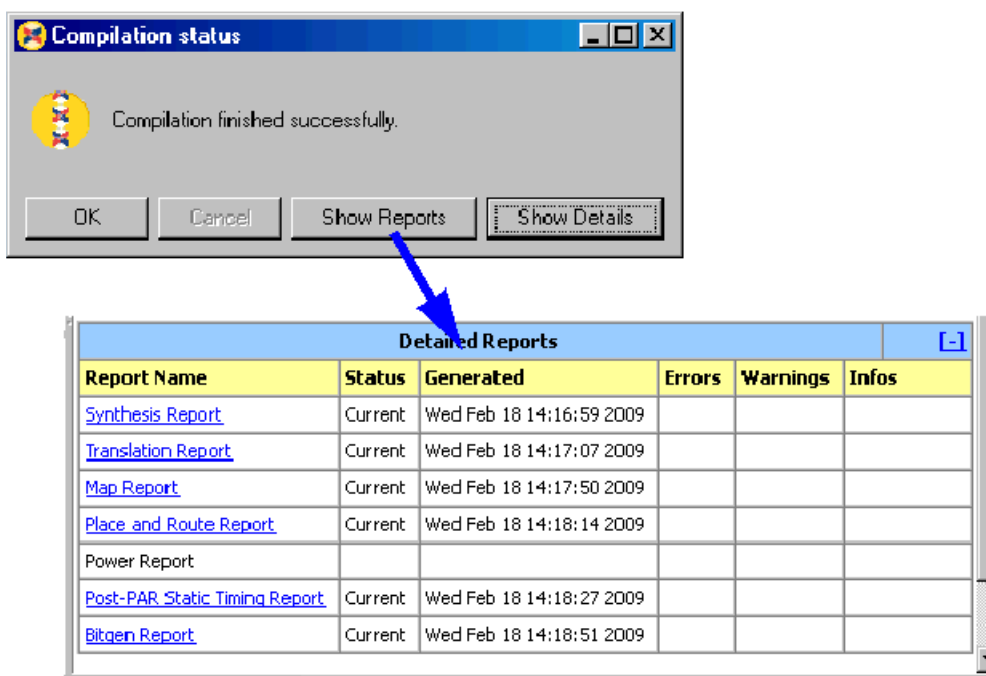

## Compilation Results

This topic discusses the low-level files System Generator produces when **HDL Netlist** is selected on the System Generator token and **Generate** is clicked. The files consist of HDL, NGC and EDIF that implement the design. In addition, System Generator produces auxiliary files that simplify downstream processing, e.g., bringing the design into Project Navigator, simulating using an HDL simulator, and synthesizing using various synthesis tools. All files are written to the target directory specified on the System Generator token.



If no testbench is requested, then the key files produced by System Generator are the following:

File Name or Type	Description
<design>.vhd/.v	This contains most of the HDL for the design
<design>_cw.vhd/.v	This is a HDL wrapper for <design>_files.vhd/.v. It drives clocks and clock enables.
.edn and .ngc files	Besides writing HDL, System Generator runs CORE Generator™ (coregen) to implement portions of the design. Coregen writes EDIF files whose names typically look something like multiplier_virtex2_6_0_83438798287b830b.edn. Other required files may be supplied as .ngc files.
globals	This file consists of key/value pairs that describe the design. The file is organized as a Perl hash table so that the keys and values can be made available to Pearl scripts using Perl evals.
<design>_cw.xcf (or .ncf)	This contains timing and port location constraints. These are used by the Xilinx synthesis tool XST and the Xilinx implementation tools. If the synthesis tool is set to something other than XST, then the suffix is changed to .ncf.
<design>_cw.ise	This allows the HDL and EDIF to be brought into the Xilinx project management tool Project Navigator.
hdlFiles	This contains the full list of HDL files written by System Generator. The files are listed in the usual HDL dependency order.
synplify_<design>.prj, or xst_<design>.pr	These files allow the design to be compiled by the synthesis tool you specified.
vcom.do	This script can be used in ModelSim to compile the HDL for a behavioral simulation of the design.

If a testbench is requested, then, in addition to the above, System Generator produces files that allow simulation results to be compared. The comparisons are between Simulink simulation results and corresponding results from ModelSim. The additional files are the following:

File Name or Type	Description
Various .dat files	These contain the simulation results from Simulink.
<design>_tb.vhd/.v	This is a testbench that wraps the design. When simulated in ModelSim, this testbench compares simulation results from Simulink against those produced by ModelSim.
vsim.do	This script can be used in ModelSim to run a testbench simulation.
pn_behavioral.do, pn_postmap.do, pn_postpar.do, pn_posttranslate.do	These files allow various ModelSim simulations to be started inside Project Navigator.

## Using the System Generator Constraints File

When a design is compiled, System Generator produces a *constraints file* that tells downstream tools how to process the design. This enables the tools to produce a higher quality implementation, and to do so using considerably less time. Constraints supply the following:

- The period to be used for the system clock;
- The speed, with respect to the system clock, at which various portions of the design must run;
- The pin locations at which ports should be placed;
- The speed at which ports must operate.

The file format depends on the synthesis tool that is specified in the System Generator token. When XST is selected, the file is written in the XCF format; for Synplify and Synplify Pro, the NCF format is used. The file name ends with `.xcf` or `.ncf`, as appropriate.

### System Clock Period

The system clock period (i.e., the period of the fastest hardware clock in the design) can be specified in the System Generator token. System Generator writes this period to the constraints file. Downstream tools use the period as a goal when implementing the design.

### Multicycle Path Constraints

Many designs consist of parts that run at different clock rates. For the fastest part, the system clock period is used. For the remaining parts, the clock period is an integer multiple of the system clock period. It is important that downstream tools know what speed each part of the design must achieve. With this information, efficiency and effectiveness of the tools are greatly increased, resulting in reduced compilation times and improved hardware realizations. The division of the design into parts, and the speed at which each part must run, are specified in the constraints file using multicycle path constraints.

### IOB Timing and Placement Constraints

When translated into hardware, System Generator's Gateway In and Gateway Out blocks become input and output ports. The locations of these ports and the speeds at which they must operate can be entered in the Gateway In and Out parameter dialog boxes.

See the descriptions of the [Gateway In](#) block and the [Gateway Out](#) block for more information. Port location and speed are specified in the constraints file by IOB timing.

## Constraints Example

The figure below shows a small multirate design and the constraints System Generator produces for it.

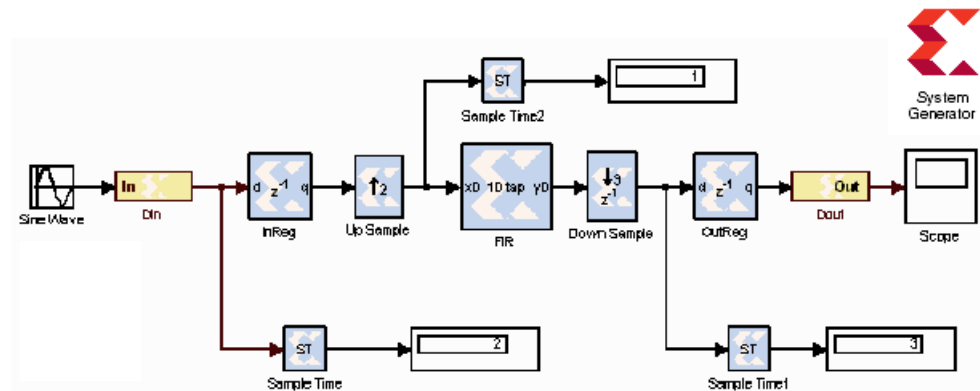

The up sampler doubles the rate, and the down sampler divides the rate by three. Assume the system clock period is 10 ns. Then the clock periods are 10 ns for the FIR, 20 ns for the input register, and 30 ns for the output register. The following text describes the constraints that convey this information.

The lines that indicate the system clock period is 10 ns are the following:

```
# Global period constraint
NET "clk" TNM_NET = "clk_392b7670";
TIMESPEC "TS_clk_392b7670" = PERIOD "clk_392b7670" 10.0 ns HIGH 50 %;
```

To build timing constraints, the blocks in the design are partitioned into timing groups. Two blocks are in the same timing group if and only if they run at the same sample rate. In this design there are three timing groups, corresponding to the three rates. The nature of constraints dictates that no name is needed for the fastest group. The remaining groups are named *ce\_2\_392b7670\_group* and *ce\_3\_392b7670\_group*; they correspond to periods 20 ns and 30 ns respectively.

The FIR runs at the system (i.e., fastest) rate and therefore is constrained using the global period constraint shown above. The logic used to generate clocks always runs at the system rate and is also constrained to the system rate.

The *ce\_2\_392b7670\_group* consists of the blocks that operate at half the system rate, i.e., the input register and the up sampler. Every block in the group is driven by the clock enable net named *ce2\_sysgen*. The constraints that define the group are the following:

```
# ce_2_392b7670_group and inner group constraint
Net "ce_2_sg_x0*" TNM_NET = "ce_2_392b7670_group";
TIMESPEC "TS_ce_2_392b7670_group_to_ce_2_392b7670_group" = FROM
"ce_2_392b7670_group" TO "ce_2_392b7670_group" 20.0 ns;
```

**Note:** A wildcard character is added to the net name to constrain any additional copies of this net that may be generated when clock enable logic is replicated. The maximum fanout of a clock enable net can be controlled in the synthesis tool.

The *ce\_3\_392b7670\_group* operates at one third the system rate. It contains the down sampler and the output register, and is defined in a similar manner to the *ce2\_group*.

```
# ce_3_392b7670_group and inner group constraint
Net "ce_3_sg_x0*" TNM_NET = "ce_3_392b7670_group";
```

```
TIMESPEC "TS_ce_3_392b7670_group_to_ce_3_392b7670_group" = FROM
"ce_3_392b7670_group" TO "ce_3_392b7670_group" 30.0 ns;
```

Group to group constraints establish relative speeds. Here are the constraints that relate the speeds of *ce\_2\_392b7670\_group* and *ce\_3\_392b7670\_group*:

```
# Group-to-group constraints
TIMESPEC "TS_ce_2_392b7670_group_to_ce_3_392b7670_group" = FROM
"ce_2_392b7670_group" TO "ce_3_392b7670_group" 20.0 ns;
TIMESPEC "TS_ce_3_392b7670_group_to_ce_2_392b7670_group" = FROM
"ce_3_392b7670_group" TO "ce_2_392b7670_group" 20.0 ns;
```

Port timing requirements can be set in the parameter dialog boxes for gateways. These requirements are translated into port constraints such as those shown below. In this example, the 3-bit *din* input is constrained to operate at its gateway's sample rate (corresponding to a period of 20 ns). The "FAST" attributes indicate the ports should be implemented using hardware that reduces delay. The reduction comes at a cost of increased noise and power consumption.

```
# Offset in constraints
NET "din(0)" OFFSET = IN : 20.0 : BEFORE "clk";
NET "din(0)" FAST;
NET "din(1)" OFFSET = IN : 20.0 : BEFORE "clk";
NET "din(1)" FAST;
NET "din(2)" OFFSET = IN : 20.0 : BEFORE "clk";
NET "din(2)" FAST;
```

Selecting **Specify IOB Location Constraints** for a gateway allows port locations to be specified. The locations must be entered as a cell array of strings in the box labeled **IOB Pad Locations**. Locations are package-specific; in this example a Virtex®-E 2000 in a FG680 package is used. The location constraints for the *din* bus are provided in the dialog box as `{'D35', 'B36', 'C35'}`. This is translated into constraints in the .xcf (or .ncf) file in the following way:

```
# Loc constraints
NET "din(2)" LOC = "D35";
NET "din(1)" LOC = "B36";
NET "din(0)" LOC = "C35";
Clock Handling in HDL
```

## Clock Handling in HDL

This topic describes how System Generator handles hardware clocks in the HDL it generates. Assume the design is named `<design>`, and `<design>` is an acceptable HDL identifier. When System Generator compiles the design, it writes a collection of HDL entities or modules, the topmost of which is named `<design>`, and is stored in a file named `<design>.vhd/.v`.

### The “Clock Enables” Multirate Implementation

Clock and clock enables appear in pairs throughout the HDL. Typical clock names are *clk\_1*, *clk\_2*, and *clk\_3*, and the names of the companion clock enables are *ce\_1*, *ce\_2*, and *ce\_3* respectively. The name tells the rate for the clock/clock enable pair; logic driven by *clk\_1* and *ce\_1* runs at the system (i.e., fastest) rate, while logic driven by (say) *clk\_2* and *ce\_2* runs at half the system rate. Clocks and clock enables are not driven in the entity or module named `<design>` or any subsidiary entities; instead, they are exposed as top-level input ports

Of course, there must be a way to generate these clocks and clock enables. System Generator produces a separate *clock wrapper* (written to a file named

<design>\_cw.vhd/ .v) to do this. This wrapper is external to the files described above. The idea is to make the HDL flexible. In some applications, the files described above are added to a larger design, but the clock wrapper is omitted. In this case, you are responsible for generating clocks and clock enables, but a finer degree of control is obtained. If, on the other hand, the clock wrapper is suitable for the application, then include it.

The names of the clocks and clock enables in System Generator HDL suggest that clocking is completely general, but this is not the case. To illustrate this, assume a design has clocks named *clk\_1* and *clk\_2*, and companion clock enables named *ce\_1* and *ce\_2* respectively. You might expect that working hardware could be produced if the *ce\_1* and *ce\_2* signals were tied high, and *clk\_2* were driven by a clock signal whose rate is half that of *clk\_1*. For most System Generator designs this does not work. Instead, *clk\_1* and *clk\_2* must be driven by the same clock, *ce\_1* must be tied high, and *ce\_2* must vary at a rate half that of *clk\_1* and *clk\_2*.

The clock wrapper consists of two components: one for the design itself, and one *clock driver component* that generate clocks and clock enables. The clock driver is contained in a file named <design>\_cw.vhd/ .v. The logic within the <design>\_cw generates the *ce\_x* signals. The optional *ce\_clr* port would be generated if the design was generated by selecting **Provide clock enable clear pin** on the System Generator token. The ports that are not clocks or clock enables are passed through to the exterior of the clock wrapper. Schematically, the clock wrapper looks like the diagram below.

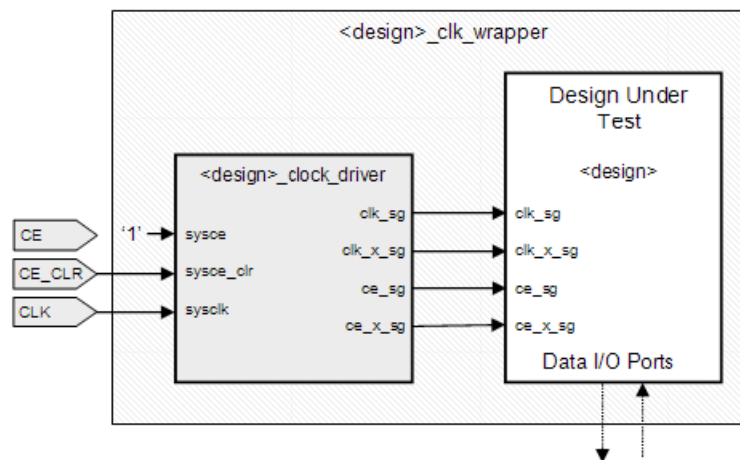

**Note:** The clock wrapper exposes a port named *ce*. The port does nothing except to serve as a companion to the *clk* port on the wrapper. The reason for having the port is to allow the clock wrapper to be used as a black box in System Generator designs.

### The “Hybrid DCM-CE” Multirate Implementation

If the implementation target is an FPGA with a Digital Clock Manager (DCM), you can choose to drive the clock tree with a DCM. The DCM option is desirable when high fanout on clock enable nets make it difficult to achieve timing closure.

System Generator instantiates the DCM in a top-level HDL clock wrapper ( with a suffix *\_dcm\_mcw*) and configures the DCM to provide up to three clock ports at different rates for Virtex®-4 and Virtex®-5 and up to two clock ports for Spartan-3A DSP. If the design has more clock ports than the DCM can support, the remaining clocks are supported with the CE (clock enable) configuration as described in the previous topic.

For a detailed examination of the files produced by this option, refer to the topic [Tutorial Example: Using the Hybrid DCM-CE Option](#).

## The “Expose Clock Ports” Multirate Implementation

When you select this option, System Generator creates a top-level wrapper that exposes a clock port for each rate. You can then manually instantiate a clock generator outside the design to drive the clock ports.

For a detailed examination of the files produced by this option, refer to the topic [Tutorial Example: Using the Expose Clock Ports Option](#).

## Core Caching

System Generator uses cores produced by Xilinx CORE Generator™ (coregen) to implement parts of designs. Generating cores can be expensive, so System Generator caches previously generated ones. Before coregen is called, System Generator looks in the cache, and if the core has already been generated, System Generator reuses it.

By default, the cache is the directory \$TEMP/sg\_core\_cache. And by default, System Generator caches no more than 2,000 cores. When the limit is reached, System Generator deletes cached cores to make room for new ones.

**Note:** Environment variables can be used to change the location of the cache and the cache size limit. The variables are described below.

Environment Variable	Description
SGCORECACHE	Location to store cached files. Setting this variable to a string of blanks instructs System Generator not to cache cores.
SGCORECACHELIMIT	Maximum number of cores to cache.

## HDL Testbench

Ordinarily, System Generator designs are bit and cycle-accurate, so Simulink simulation results exactly match those seen in hardware. There are, however, times when it is useful to compare Simulink simulation results against those obtained from an HDL simulator. In particular, this makes sense when the design contains black boxes. The **Create Testbench** checkbox in the System Generator token makes this possible.

Suppose the design is named <design>, and a System Generator token is placed at the top of the design. Suppose also that in the token the **Compilation** field is set to **HDL Netlist**, and the **Create Testbench** checkbox is selected. When the **Generate** button is clicked, System Generator produces the usual files for the design, and in addition writes the following:

1. A file named <design>\_tb.vhd/.v that contains a testbench HDL entity;
2. Various .dat files that contain test vectors for use in an HDL testbench simulation.
3. Scripts vcom.do and vsim.do that can be used in ModelSim to compile and simulate the testbench, comparing Simulink test vectors against those produced in HDL.

System Generator generates the .dat files by saving the values that pass through gateways. In the HDL simulation, input values from the .dat files are stimuli, and output values are expected results. The testbench is simply a wrapper that feeds the stimuli to the HDL for the design, then compares HDL results against expected ones.

## Compiling MATLAB into an FPGA

System Generator provides direct support for MATLAB through the MCode block. The MCode block applies input values to an M-function for evaluation using Xilinx's fixed-point data type. The evaluation is done once for each sample period. The block is capable of keeping internal states with the use of persistent state variables. The input ports of the block are determined by the input arguments of the specified M-function and the output ports of the block are determined by the output arguments of the M-function. The block provides a convenient way to build finite state machines, control logic, and computation heavy systems.

In order to construct an MCode block, an M-function must be written. The M-file must be in the directory of the model file that is to use the M-file or in a directory in the MATLAB path.

This tutorial provides ten examples that use the MCode block:

- Example 1 [Simple Selector](#) shows how to implement a function that returns the maximum value of its inputs;
- Example 2 [Simple Arithmetic Operations](#) shows how to implement simple arithmetic operations;
- Example 3 [Complex Multiplier with Latency](#) shows how to build a complex multiplier with latency;
- Example 4 [Shift Operations](#) shows how to implement shift operations;
- Example 5 [Passing Parameters into the MCode Block](#) shows how to pass parameters into a MCode block;
- Example 6 [Optional Input Ports](#) shows how to implement optional input ports on an MCode block;
- Example 7 [Finite State Machines](#) shows how to implement a finite state machine;
- Example 8 [Parameterizable Accumulator](#) shows how to build a parameterizable accumulator;
- Example 9 [FIR Example and System Verification](#) shows how to model FIR blocks and how to do system verification;
- Example 10 [RPN Calculator](#) shows how to model a RPN calculator – a stack machine;
- Example 11 [Example of disp Function](#) shows how to use disp function to print variable values.

The first two examples are in the `mcode_block_tutorial.mdl` file of the `examples/mcode_block` directory in your installation of the System Generator software. Examples 3 and 4 are in the `mcode_block_tutorial2.mdl` file. Examples 5 and 6 are in the `mcode_block_tutorial3.mdl` file. Examples 7 and 8 are in the `mcode_block_tutorial4.mdl` file. Example 9 is `mcode_block_verify_fir.mdl`. Example 10 is in `mcode_block_rpn_calculator.mdl`.

### Simple Selector

This example is a simple controller for a data path, which assigns the maximum value of two inputs to the output. The M-function is specified as the following and is saved in an M-file `x1max.m`:

```
function z = x1max(x, y)
    if x > y
        z = x;
```



```

else
    z = y;
end

```

The `xlmax.m` file should be either saved in the same directory of the model file or should be in the MATLAB path. Once the `xlmax.m` has been saved to the appropriate place, you should drag a MCode block into your model, open the block parameter dialog box, and enter `xlmax` into the **MATLAB Function** field. After clicking the **OK** button, the block has two input ports `x` and `y`, and one output port `z`.

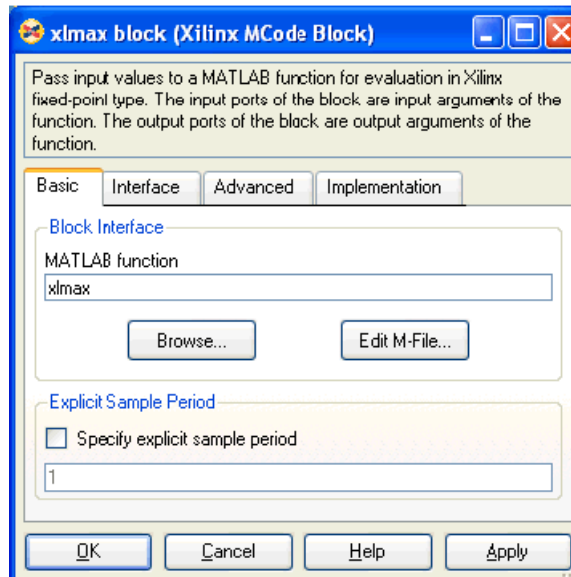

The following figure shows what the block looks like after the model is compiled. You can see that the block calculates and sets the necessary fixed-point data type to the output port.

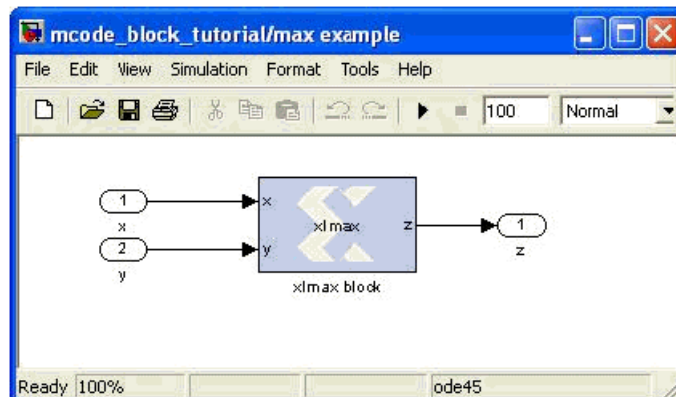

## Simple Arithmetic Operations

This example shows some simple arithmetic operations and type conversions. The following shows the `xlSimpleArith.m` file, which specifies the `xlSimpleArith` M-function.

```

function [z1, z2, z3, z4] = xlSimpleArith(a, b)
% xlSimpleArith demonstrates some of the arithmetic operations
% supported by the Xilinx MCode block. The function uses xfix()
% to create Xilinx fixed-point numbers with appropriate

```



```
% container types.%
% You must use a xfix() to specify type, number of bits, and
% binary point position to convert floating point values to
% Xilinx fixed-point constants or variables.
% By default, the xfix call uses xlTruncate
% and xlWrap for quantization and overflow modes.
% const1 is Ufix_8_3
const1 = xfix({xlUnsigned, 8, 3}, 1.53);
% const2 is Fix_10_4
const2 = xfix({xlSigned, 10, 4, xlRound, xlWrap}, 5.687);
z1 = a + const1;
z2 = -b - const2;
z3 = z1 - z2;
% convert z3 to Fix_12_8 with saturation for overflow
z3 = xfix({xlSigned, 12, 8, xlTruncate, xlSaturate}, z3);
% z4 is true if both inputs are positive
z4 = a>const1 & b>-1;
```

This M-function uses addition and subtraction operators. The MCode block calculates these operations in full precision, which means the output precision is sufficient to carry out the operation without losing information.

One thing worth discussing is the `xfix` function call. The function requires two arguments: the first for fixed-point data type precision and the second indicating the value. The precision is specified in a cell array. The first element of the precision cell array is the type value. It can be one of three different types: `xlUnsigned`, `xlSigned`, or `xlBoolean`. The second element is the number of bits of the fixed-point number. The third is the binary point position. If the element is `xlBoolean`, there is no need to specify the number of bits and binary point position. The number of bits and binary point position must be specified in pair. The fourth element is the quantization mode and the fifth element is the overflow mode. The quantization mode can be one of `xlTruncate`, `xlRound`, or `xlRoundBanker`. The overflow mode can be one of `xlWrap`, `xlSaturate`, or `xlThrowOverflow`. Quantization mode and overflow mode must be specified as a pair. If the quantization-overflow mode pair is not specified, the `xfix` function uses `xlTruncate` and `xlWrap` for signed and unsigned numbers. The second argument of the `xfix` function can be either a double or a Xilinx fixed-point number. If a constant is an integer number, there is no need to use the `xfix` function. The Mcode block converts it to the appropriate fixed-point number automatically.

After setting the dialog box parameter **MATLAB Function** to `xlSimpleArith`, the block shows two input ports `a` and `b`, and four output ports `z1`, `z2`, `z3`, and `z4`.

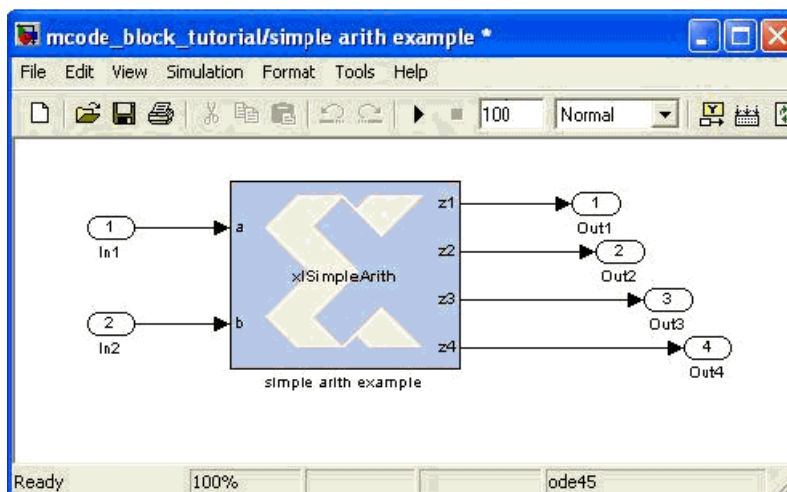
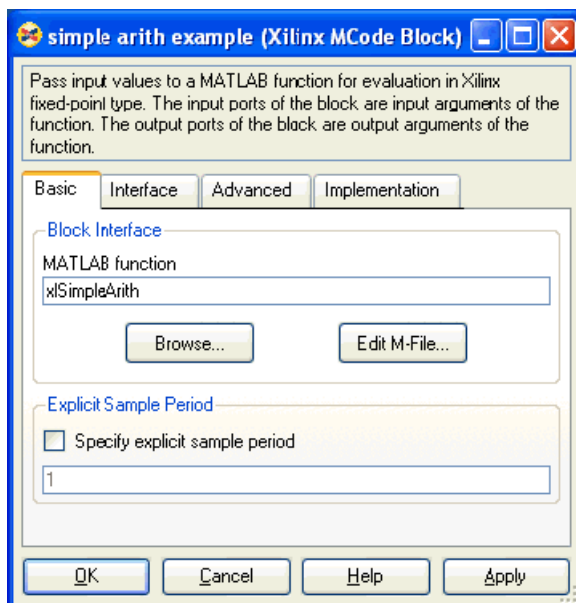

M-functions using Xilinx data types and functions can be tested in the MATLAB command window. For example, if you type: `[z1, z2, z3, z4] = xlSimpleArith(2, 3)` in the MATLAB command window, you'll get the following lines:

```

UFix(9, 3): 3.500000
Fix(12, 4): -8.687500
Fix(12, 8): 7.996094
Bool: true
    
```

Notice that the two integer arguments (2 and 3) are converted to fixed-point numbers automatically. If you have a floating-point number as an argument, an `xfix` call is required.

## Complex Multiplier with Latency

This example shows how to create a complex number multiplier. The following shows the `xlcpymult.m` file which specifies the `xlcpymult` function.

```

function [xr, xi] = xlcpymult(ar, ai, br, bi)
    xr = ar * br - ai * bi;
    xi = ar * bi + ai * br;
    
```

The following diagram shows the sub-system:

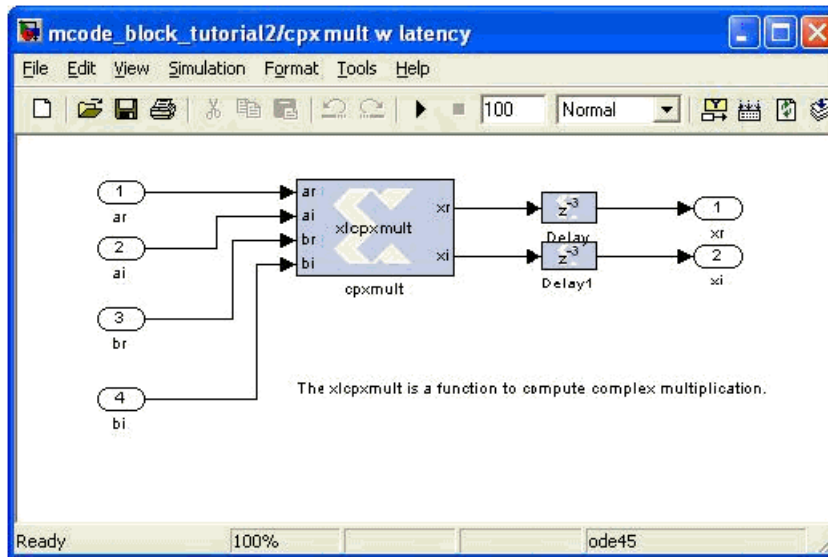

Two delay blocks are added after the MCode block. By selecting the option **Implement using behavioral HDL** on the Delay blocks, the downstream logic synthesis tool is able to perform the appropriate optimizations to achieve higher performance.

## Shift Operations

This example shows how to implement bit-shift operations using the MCode block. Shift operations are accomplished with multiplication and division by powers of two. For example, multiplying by 4 is equivalent to a 2-bit left-shift, and dividing by 8 is equivalent to a 3-bit right-shift. Shift operations are implemented by moving the binary point position and if necessary, expanding the bit width. Consequently, multiplying a Fix\_8\_4 number by 4 results in a Fix\_8\_2 number, and multiplying a Fix\_8\_4 number by 64 results in a Fix\_10\_0 number.

The following shows the `xlsimpleshift.m` file which specifies one left-shift and one right-shift:

```
function [lsh3, rsh2] = xlsimpleshift(din)
% [lsh3, rsh2] = xlsimpleshift(din) does a left shift
% 3 bits and a right shift 2 bits.
% The shift operation is accomplished by
% multiplication and division of power
% of two constant.
lsh3 = din * 8;
rsh2 = din / 4;
```

The following diagram shows the sub-system after compilation:

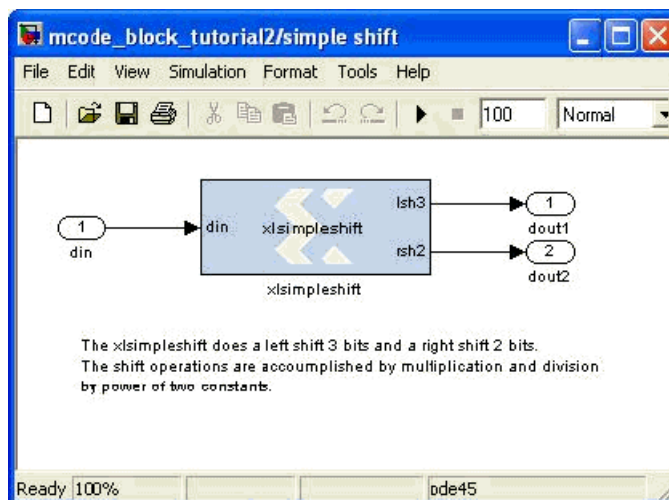

## Passing Parameters into the MCode Block

This example shows how to pass parameters into the MCode block. An input argument to an M-function can be interpreted either as an input port on the MCode block, or as a parameter internal to the block.

The following M-code defines an M-function `x1_sconvert` is contained in file `x1_sconvert.m`:

```
function dout = x1_sconvert(din, nbits, binpt)
    proto = {xlSigned, nbits, binpt};
    dout = xfix(proto, din);
```

The following diagram shows a subsystem containing two MCode blocks that use M-function `x1_sconvert`. The arguments `nbits` and `binpt` of the M-function are specified differently for each block by passing different parameters to the MCode blocks. The parameters passed to the MCode block labeled `signed convert 1` cause it to convert the input data from type `Fix_16_8` to `Fix_10_5` at its output. The parameters passed to the MCode block labeled `signed convert 2` causes it to convert the input data from type `Fix_16_8` to `Fix_8_4` at its output.

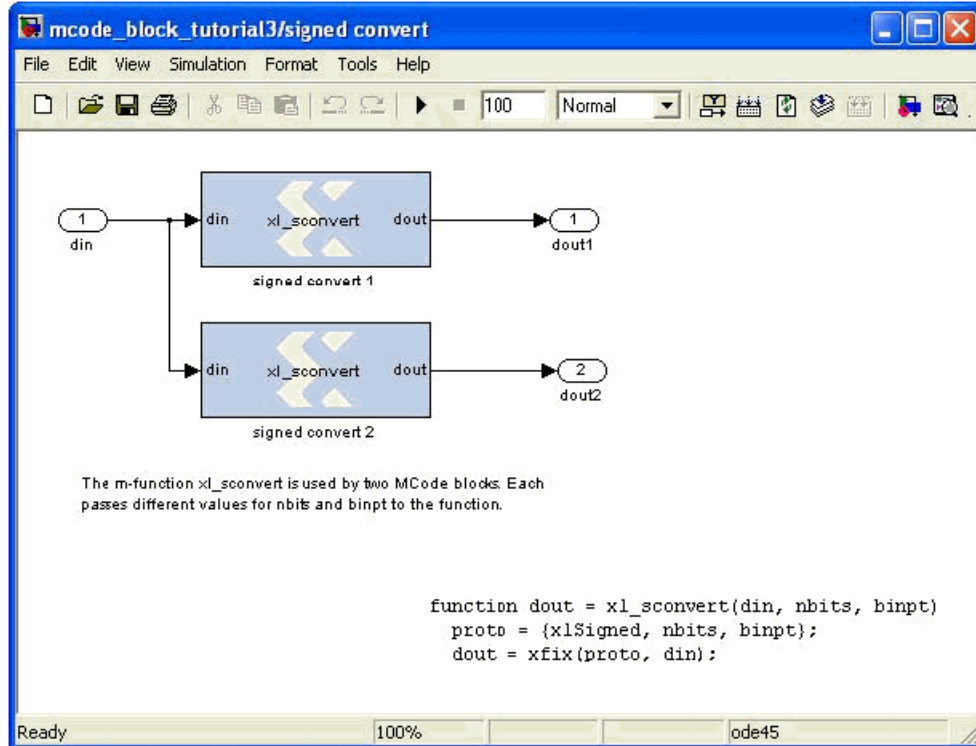

To pass parameters to each MCode block in the diagram above, you can click the **Edit Interface** button on the block GUI then set the values for the M-function arguments. The mask for MCode block signed convert 1 is shown below:

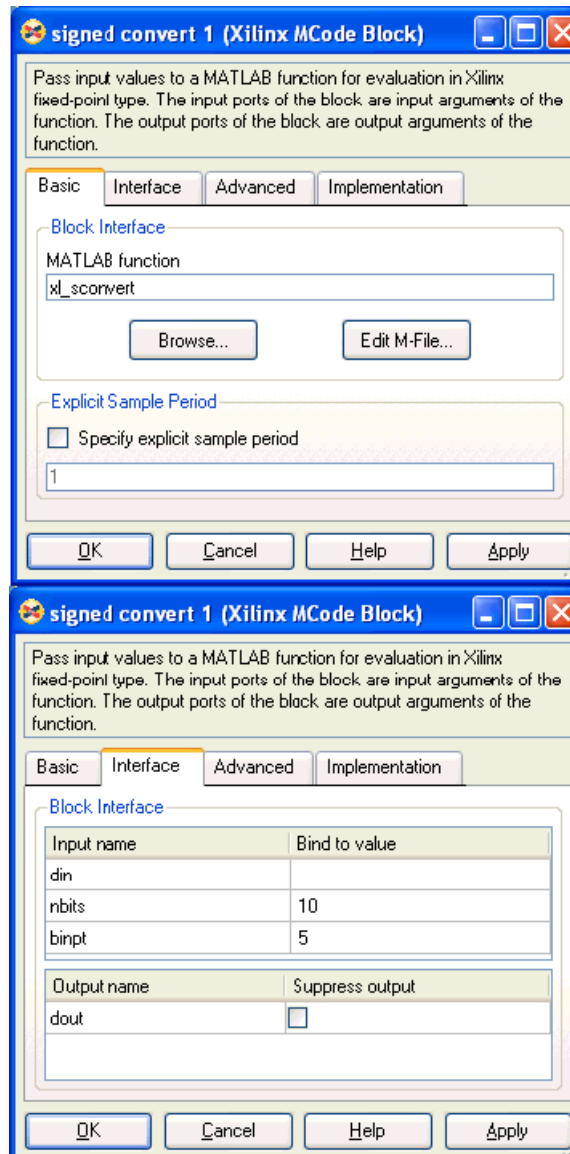

The above interface window sets the M-function argument `nbits` to be 10 and `binpt` to be 5. The mask for the MCode block signed `convert_2` is shown below:

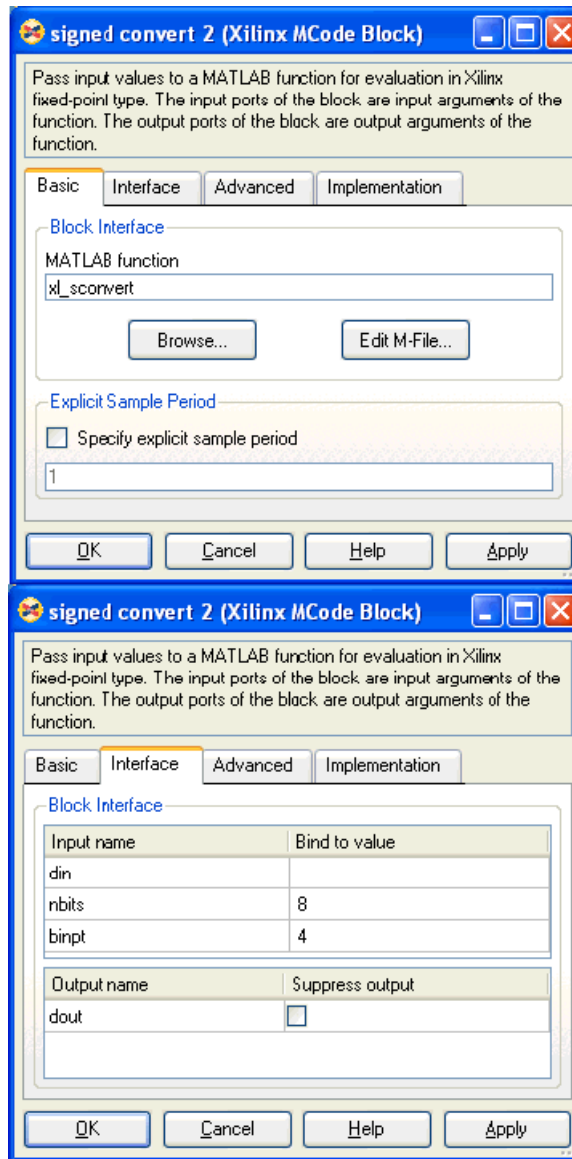

The above interface window sets the M-function argument `nbits` to be 8 and `binpt` to be 4.

## Optional Input Ports

This example shows how to use the parameter passing mechanism of MCode blocks to specify whether or not to use optional input ports on MCode blocks.

The following M-code, which defines M-function `xl_m_addsub` is contained in file `xl_m_addsub.m`:

```
function s = xl_m_addsub(a, b, sub)
    if sub
        s = a - b;
    else
        s = a + b;
    end
end
```

The following diagram shows a subsystem containing two MCode blocks that use M-function `xl_m_addsub`.

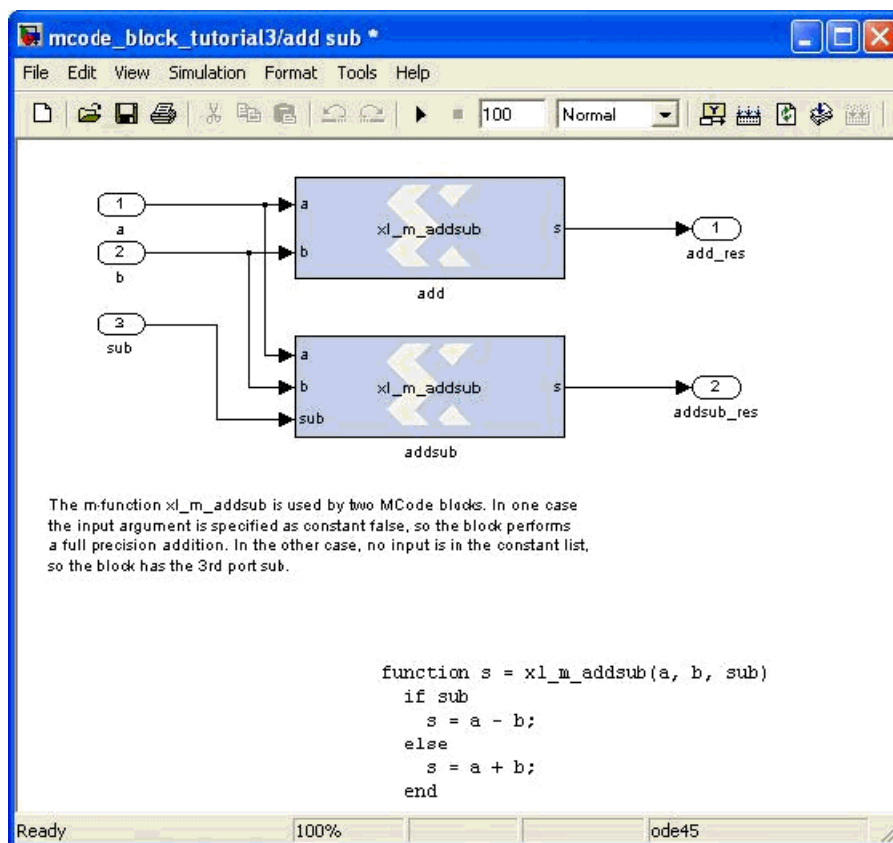



The Block Interface Editor of the MCode block labeled add is shown in below.

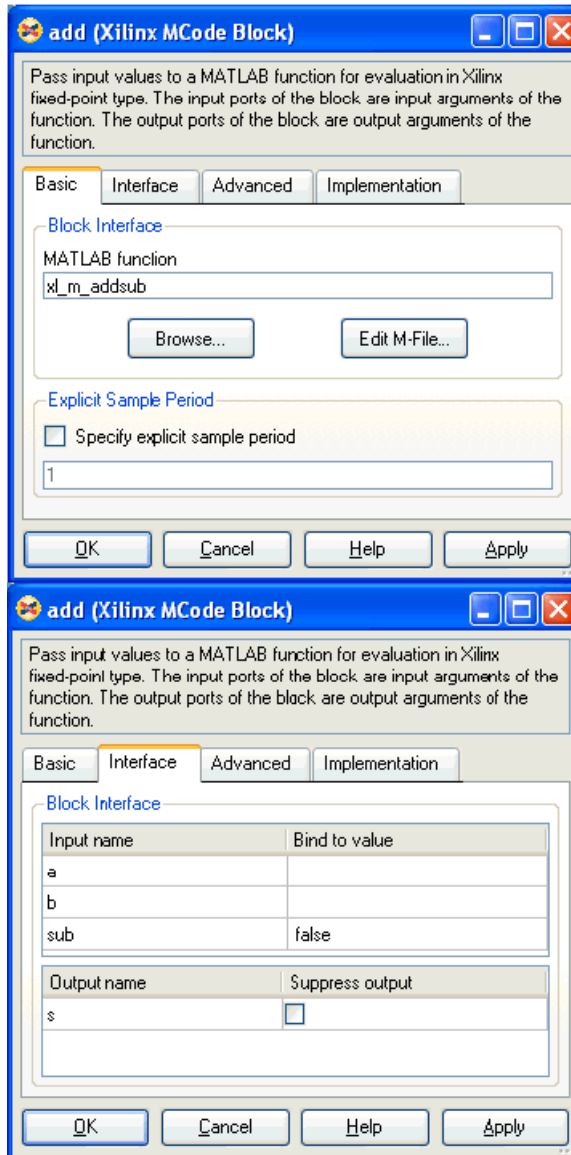

As a result, the add block features two input ports a and b; it performs full precision addition. Input parameter sub of the MCode block labeled addsub is not bound with any value. Consequently, the addsub block features three input ports: a, b, and sub; it performs full precision addition or subtraction based on the value of input port sub.

## Finite State Machines

This example shows how to create a finite state machine using the MCode block with internal state variables. The state machine illustrated below detects the pattern 1011 in an input stream of bits.

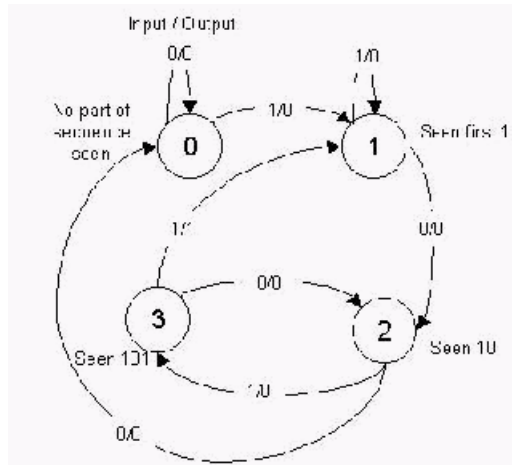

The M-function that is used by the MCode block contains a transition function, which computes the next state based on the current state and the current input. Unlike example 3 though, the M-function in this example defines persistent state variables to store the state of the finite state machine in the MCode block. The following M-code, which defines function `detect1011_w_state` is contained in file `detect1011_w_state.m`:

```

function matched = detect1011_w_state(din)
% This is the detect1011 function with states for detecting a
% pattern of 1011.

seen_none = 0; % initial state, if input is 1, switch to seen_1
seen_1 = 1; % first 1 has been seen, if input is 0, switch
% seen_10
seen_10 = 2; % 10 has been detected, if input is 1, switch to
% seen_1011
seen_101 = 3; % now 101 is detected, if input is 1, 1011 is
% detected and the FSM switches to seen_1

% the state is a 2-bit register
persistent state, state = xl_state(seen_none, {xlUnsigned, 2, 0});

% the default value of matched is false
matched = false;

switch state
case seen_none
if din==1
state = seen_1;
else
state = seen_none;
end
case seen_1 % seen first 1
if din==1
state = seen_1;
else

```

```

        state = seen_10;
    end
    case seen_10 % seen 10
        if din==1
            state = seen_101;
        else
            % no part of sequence seen, go to seen_none
            state = seen_none;
        end
    case seen_101
        if din==1
            state = seen_1;
            matched = true;
        else
            state = seen_10;
            matched = false;
        end
    end
end

```

The following diagram shows a state machine subsystem containing a MCode block after compilation; the MCode block uses M-function detect1101\_w\_state.

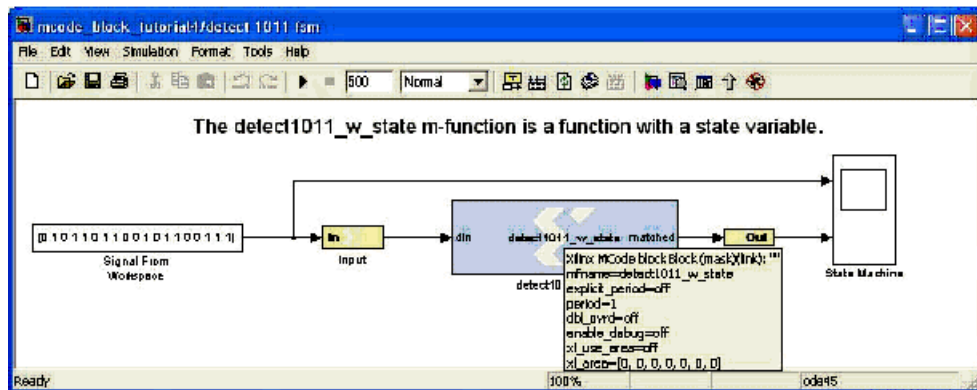

## Parameterizable Accumulator

This example shows how to use the MCode block to build an accumulator using persistent state variables and parameters to provide implementation flexibility. The following M-code, which defines function xl\_accum is contained in file xl\_accum.m:

```

function q = xl_accum(b, rst, load, en, nbits, ov, op,
    feed_back_down_scale)
% q = xl_accum(b, rst, nbits, ov, op, feed_back_down_scale) is
% equivalent to our Accumulator block.
binpt = xl_binpt(b);
init = 0;
precision = {xlSigned, nbits, binpt, xlTruncate, ov};
persistent s, s = xl_state(init, precision);
q = s;
if rst
    if load
        % reset from the input port
        s = b;
    else
        % reset from zero
        s = init;
    end
end

```

```

end
else
if ~en
else
% if enabled, update the state
if op==0
s = s/feed_back_down_scale + b;
else
s = s/feed_back_down_scale - b;
end
end
end
end
end

```

The following diagram shows a subsystem containing the accumulator MCode block using M-function `x1_accum`. The MCode block is labeled MCode Accumulator. The subsystem also contains the Xilinx Accumulator block, labeled Accumulator, for comparison purposes. The MCode block provides the same functionality as the Xilinx Accumulator block; however, its mask interface differs in that parameters of the MCode block are specified with a cell array in the Function Parameter Bindings parameter.

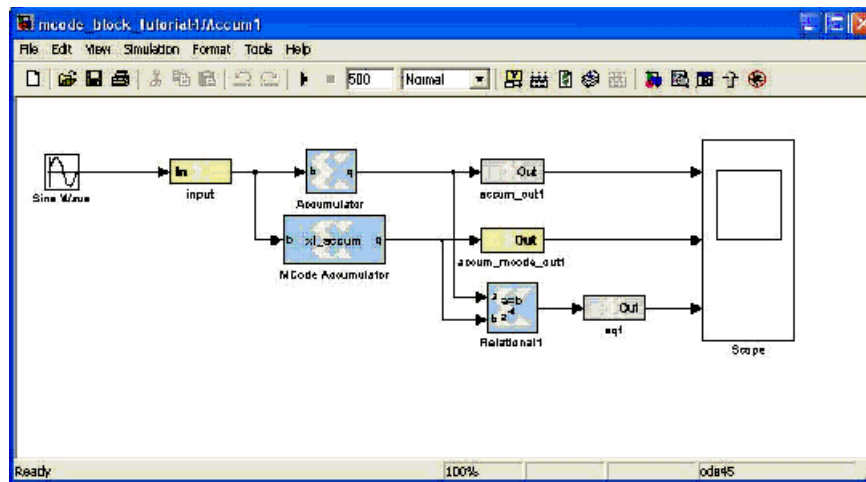

Optional inputs `rst` and `load` of block `Accum_MCode1` are disabled in the cell array of the Function Parameter Bindings parameter. The block mask for block `MCode Accumulator` is shown below:

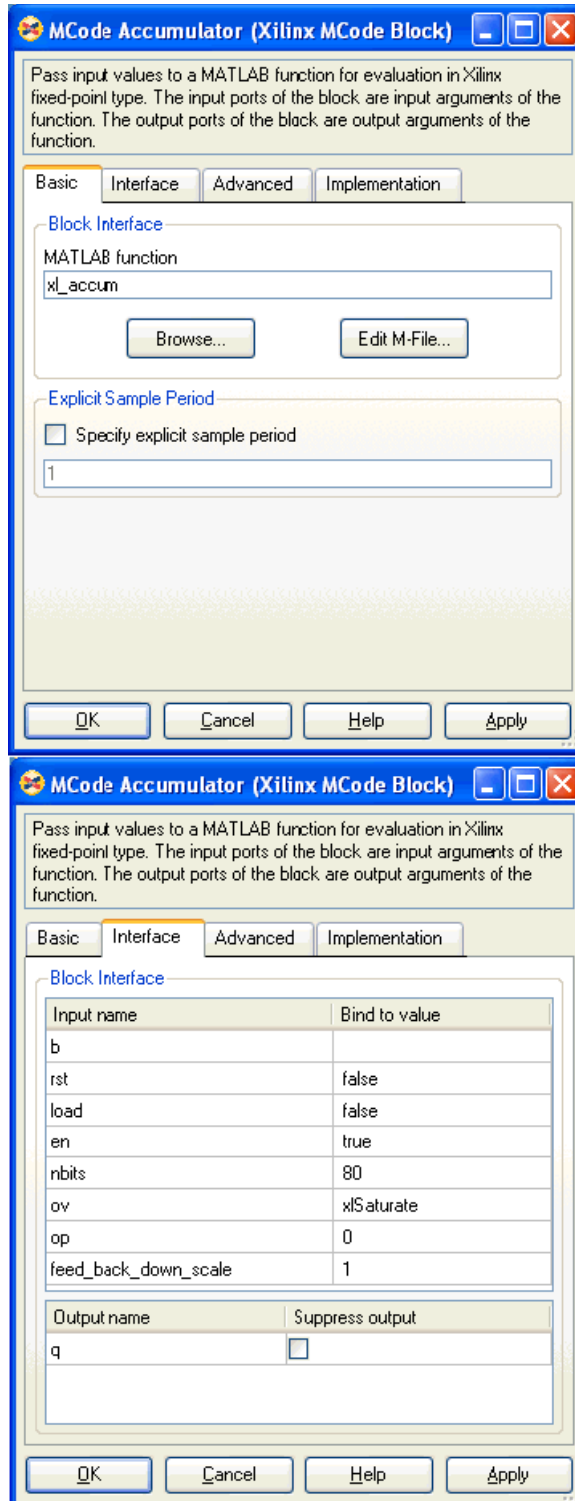

The example contains two additional accumulator subsystems with MCode blocks using the same M-function, but different parameter settings to accomplish different accumulator implementations.

## FIR Example and System Verification

This example shows how to use the MCode block to model FIRs. It also shows how to do system verification with the MCode block.

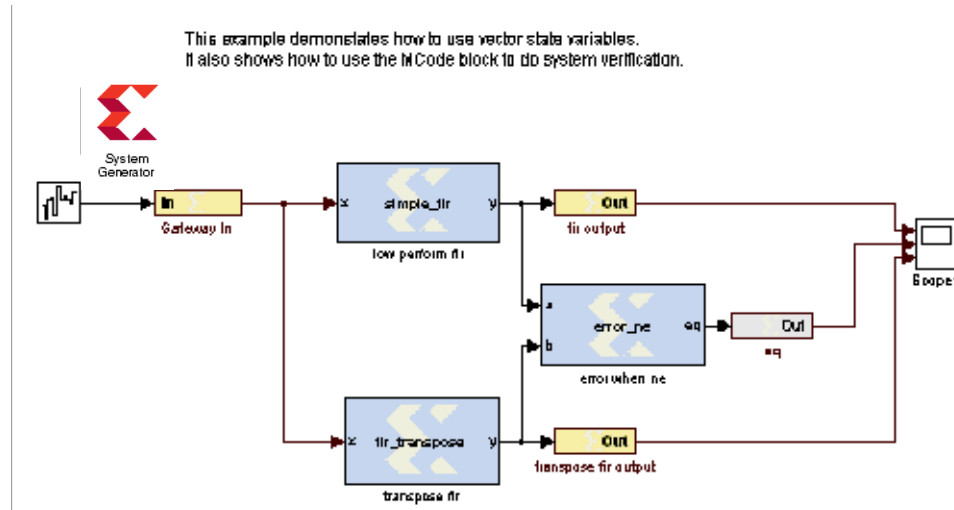

The model contains two FIR blocks. Both are modeled with the MCode block and both are synthesizable. The following are the two functions that model those two blocks.

```
function y = simple_fir(x, lat, coefs, len, c_nbits, c_binpt, o_nbits,
o_binpt)
    coef_prec = {x1Signed, c_nbits, c_binpt, x1Round, x1Wrap};
    out_prec = {x1Signed, o_nbits, o_binpt};

    coefs_xfix = xfix(coef_prec, coefs);
    persistent coef_vec, coef_vec = xl_state(coefs_xfix, coef_prec);
    persistent x_line, x_line = xl_state(zeros(1, len-1), x);
    persistent p, p = xl_state(zeros(1, lat), out_prec, lat);

    sum = x * coef_vec(0);
    for idx = 1:len-1
        sum = sum + x_line(idx-1) * coef_vec(idx);
        sum = xfix(out_prec, sum);
    end
    y = p.back;
    p.push_front_pop_back(sum);
    x_line.push_front_pop_back(x);
function y = fir_transpose(x, lat, coefs, len, c_nbits, c_binpt,
o_nbits, o_binpt)
    coef_prec = {x1Signed, c_nbits, c_binpt, x1Round, x1Wrap};
    out_prec = {x1Signed, o_nbits, o_binpt};
    coefs_xfix = xfix(coef_prec, coefs);
    persistent coef_vec, coef_vec = xl_state(coefs_xfix, coef_prec);
    persistent reg_line, reg_line = xl_state(zeros(1, len), out_prec);
    if lat <= 0
        error('latency must be at least 1');
    end
end
```

```

lat = lat - 1;
persistent dly;
if lat <= 0
    y = reg_line.back;
else
    dly = xl_state(zeros(1, lat), out_prec, lat);
    y = dly.back;
    dly.push_front_pop_back(reg_line.back);
end
for idx = len-1:-1:1
    reg_line(idx) = reg_line(idx - 1) + coef_vec(len - idx - 1) * x;
end
reg_line(0) = coef_vec(len - 1) * x;

```

The parameters are configured as following:

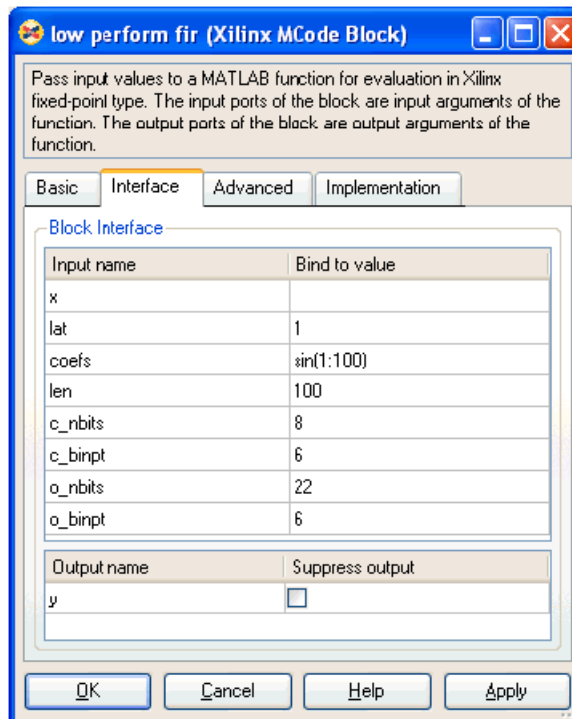

In order to verify that the functionality of two blocks are equal, we also use another MCode block to compare the outputs of two blocks. If the two outputs are not equal at any given time, the error checking block will report the error. The following function does the error checking:

```
function eq = error_ne(a, b, report, mod)
    persistent cnt, cnt = xl_state(0, {xlUnsigned, 16, 0});
    switch mod
        case 1
            eq = a==b;
        case 2
            eq = isnan(a) || isnan(b) || a == b;
        case 3
            eq = ~isnan(a) && ~isnan(b) && a == b;
        otherwise
            eq = false;
    error(['wrong value of mode ', num2str(mod)]);
end
if report
    if ~eq
        error(['two inputs are not equal at time ', num2str(cnt)]);
    end
end
cnt = cnt + 1;
```

The block is configured as following:

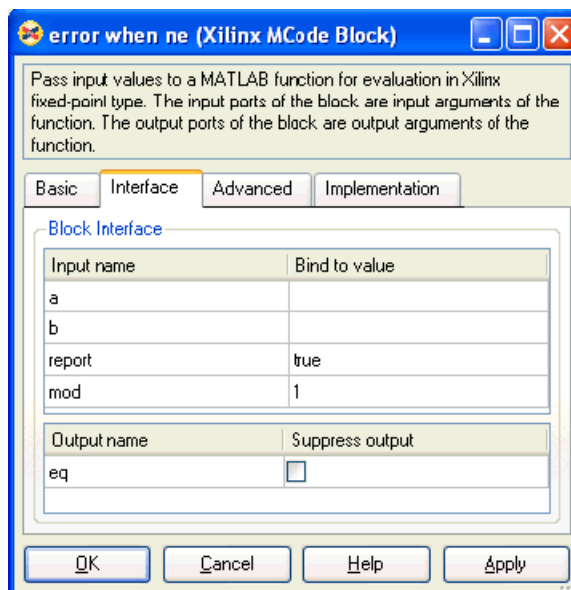



## RPN Calculator

This example shows how to use the MCode block to model a RPN calculator which is a stack machine. The block is synthesizable:

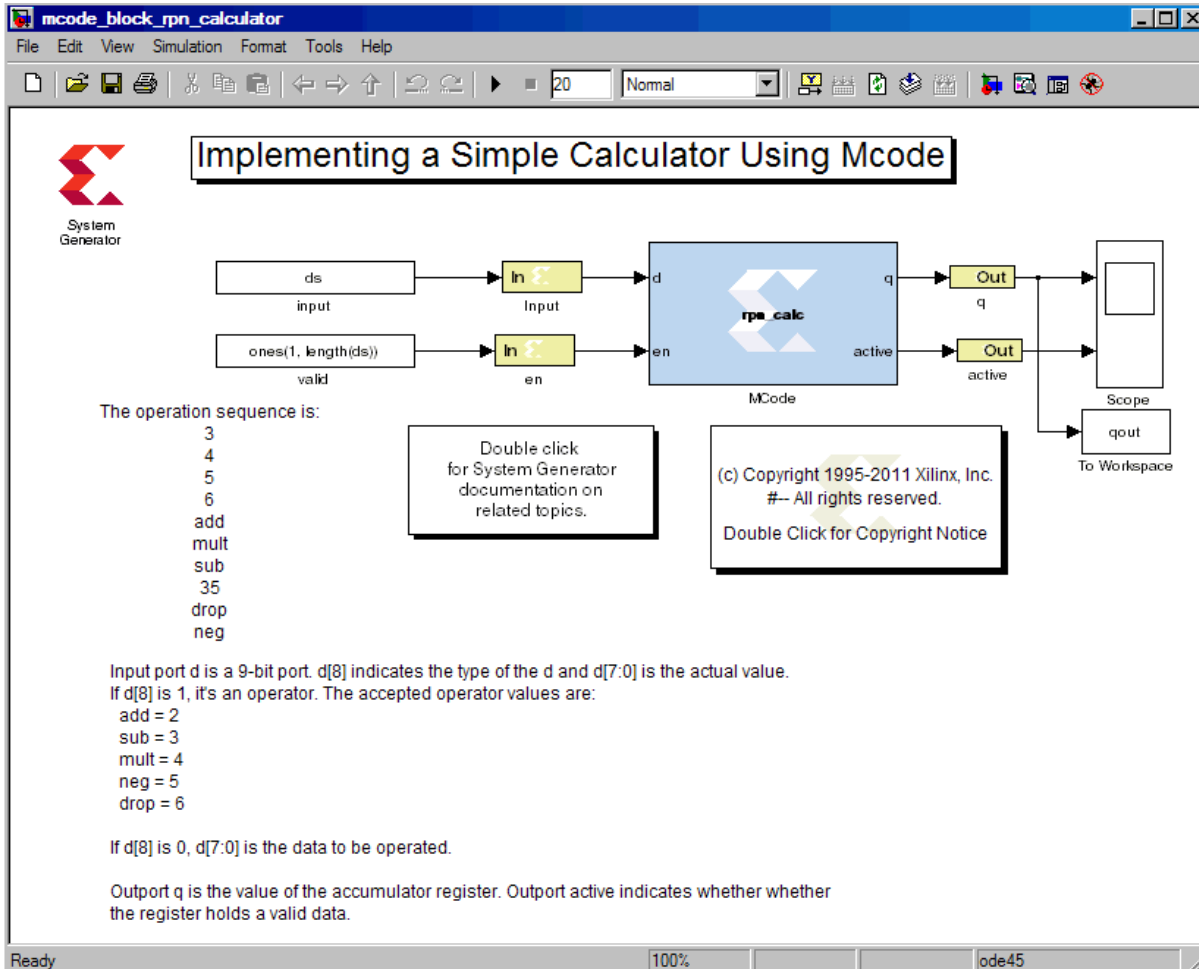

The following function models the RPN calculator.

```

function [q, active] = rpn_calc(d, rst, en)
    d_nbits = xl_nbits(d);
    % the first bit indicates whether it's a data or operator
    is_oper = xl_slice(d, d_nbits-1, d_nbits-1)==1;
    din = xl_force(xl_slice(d, d_nbits-2, 0), xlSigned, 0);
    % the lower 3 bits are operator
    op = xl_slice(d, 2, 0);
    % acc the the A register
    persistent acc, acc = xl_state(0, din);
    % the stack is implemented with a RAM and
    % an up-down counter
    persistent mem, mem = xl_state(zeros(1, 64), din);
    persistent acc_active, acc_active = xl_state(false, {xlBoolean});
    persistent stack_active, stack_active = xl_state(false, ...
                                                {xlBoolean});

    stack_pt_prec = {xlUnsigned, 5, 0};
    persistent stack_pt, stack_pt = xl_state(0, {xlUnsigned, 5, 0});
    % when en is true, it's action
    
```

```
OP_ADD = 2;
OP_SUB = 3;
OP_MULT = 4;
OP_NEG = 5;
OP_DROP = 6;
q = acc;
active = acc_active;
if rst
    acc = 0;
    acc_active = false;
    stack_pt = 0;
elseif en
    if ~is_oper
        % enter data, push
        if acc_active
            stack_pt = xfix(stack_pt_prec, stack_pt + 1);
            mem(stack_pt) = acc;
            stack_active = true;
        else
            acc_active = true;
        end
        acc = din;
    else
        if op == OP_NEG
            % unary op, no stack op
            acc = -acc;
        elseif stack_active
            b = mem(stack_pt);
            switch double(op)
                case OP_ADD
                    acc = acc + b;
                case OP_SUB
                    acc = b - acc ;
                case OP_MULT
                    acc = acc * b;
                case OP_DROP
                    acc = b;
            end
            stack_pt = stack_pt - 1;
        elseif acc_active
            acc_active = false;
            acc = 0;
        end
    end
end
stack_active = stack_pt ~= 0;
```

## Example of disp Function

The following MCode function shows how to use the disp function to print variable values.

```
function x = testdisp(a, b)
    persistent dly, dly = xl_state(zeros(1, 8), a);
    persistent rom, rom = xl_state([3, 2, 1, 0], a);
    disp('Hello World!');
    disp(['num2str(dly) is ', num2str(dly)]);
    disp('disp(dly) is ');
    disp(dly);
    disp('disp(rom) is ');
    disp(rom);
    a2 = dly.back;
    dly.push_front_pop_back(a);
    x = a + b;
    disp(['a = ', num2str(a), ', ', ' ', ...
         'b = ', num2str(b), ', ', ' ', ...
         'x = ', num2str(x)]);
    disp(num2str(true));
    disp('disp(10) is');
    disp(10);
    disp('disp(-10) is');
    disp(-10);
    disp('disp(a) is ');
    disp(a);
    disp('disp(a == b)');
    disp(a==b);
```

The Enable print with disp option must be checked.

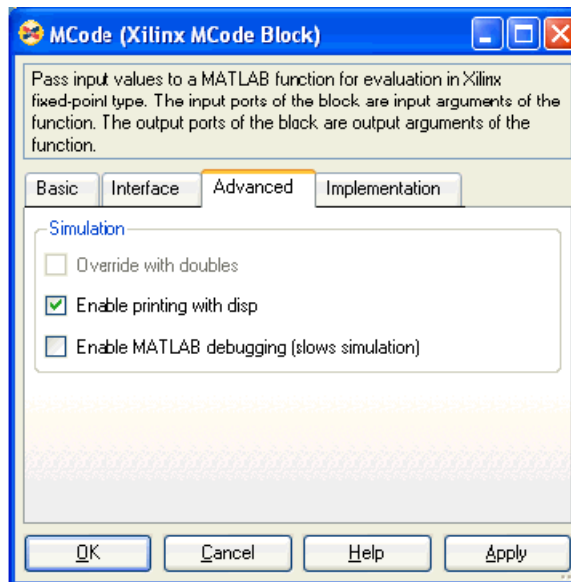

Here are the lines that are displayed on the MATLAB console for the first simulation step.

```
mcode_block_disp/MCode (Simulink time: 0.000000, FPGA clock: 0)
Hello World!
num2str(dly) is [0.000000, 0.000000, 0.000000, 0.000000, 0.000000,
0.000000, 0.000000, 0.000000]
disp(dly) is
  type: Fix_11_7,
  maxlen: 8,
  length: 8,
  0: binary 0000.0000000, double 0.000000,
  1: binary 0000.0000000, double 0.000000,
  2: binary 0000.0000000, double 0.000000,
  3: binary 0000.0000000, double 0.000000,
  4: binary 0000.0000000, double 0.000000,
  5: binary 0000.0000000, double 0.000000,
  6: binary 0000.0000000, double 0.000000,
  7: binary 0000.0000000, double 0.000000,
disp(rom) is
  type: Fix_11_7,
  maxlen: 4,
  length: 4,
  0: binary 0011.0000000, double 3.0,
  1: binary 0010.0000000, double 2.0,
  2: binary 0001.0000000, double 1.0,
  3: binary 0000.0000000, double 0.0,
a = 0.000000, b = 0.000000, x = 0.000000
1
disp(10) is
  type: UFix_4_0, binary: 1010, double: 10.0
disp(-10) is
  type: Fix_5_0, binary: 10110, double: -10.0
disp(a) is
  type: Fix_11_7, binary: 0000.0000000, double: 0.000000
disp(a == b)
  type: Bool, binary: 1, double: 1
```

## Importing a System Generator Design into a Bigger System

A System Generator design is often a sub-design that is incorporated into a larger HDL design. This topic shows how to embed two System Generator designs into a larger design and how VHDL created by System Generator can be incorporated into the simulation model of the overall system.

Starting with Release 10.1, System Generator introduced a new integration flow between System Generator (Sysgen) and Project Navigator (ProjNav). This first phase of integration concentrates on the following areas:

- Allows you to add a System Generator design as a sub-level to a larger design
- Consolidates and associates System Generator constraints to the top-level design
- Enables you to perform certain design iterations between Project Navigator and the System Generator design

### HDL Netlist Compilation

Selecting the **HDL Netlist** compilation target from the System Generator token instructs System Generator to generate HDL along with other related files such as NGC files and EDIF files that implement the design. In addition, System Generator produces auxiliary files that simplify downstream processing such as bringing the design into Project Navigator, simulating the design using an HDL simulator, and performing logic synthesis using various logic synthesis tools. See the topic [System Generator Compilation Types](#) for more details.

Starting with Release 10.1, the System Generator project information is encapsulated in the file `<design_name>_cw.sgp` or `<design_name>_mcw.sgp` depending on which clocking option is selected. This topic shows how multiple System Generator designs can be included as sub-modules in a larger design.

### Integration Design Rules

When a System Generator model is to be included into a larger design, the following two design rules must be followed.

**Rule 1:** No Gateway or System Generator token should specify an IOB/CLK location constraint. Otherwise, the NGDBuild tool will issue the following warning:

```
WARNING:NgdBuild:483 - Attribute "LOC" on "clk" is on the wrong type of object. Please see the Constraints Guide for more information on this attribute.
```

Also, IOB timing constraints should be set to "none" in this case as well to avoid the following NGDBuild error:

```
NgdBuild:756 -Could not find net(s) 'gateway_out(1)' in the design. To suppress this error, specify the correct net name or remove the constraint.
```

**Rule 2:** If there are any I/O ports from the System Generator design that are required to be bubbled up to the top-level design, appropriate buffers should be instantiated in the top-level HDL code.

## New Integration Flow between System Generator & Project Navigator

The illustration below shows the entire flow of how multiple System Generator designs can be integrated into Project Navigator as lower-level designs. System Generator generates a project file with an extension `.sgp` that you can add a System Generator source type in Project Navigator. This SGP file is an empty file by design, but by its location, it implicitly identifies the location of the System Generator model. Prior to the integration with Project Navigator in Release 10.1, you had to manually consolidate and associate UCF constraints into the top-level design. It is now done automatically during the implementation in Project Navigator as shown in the following figure.

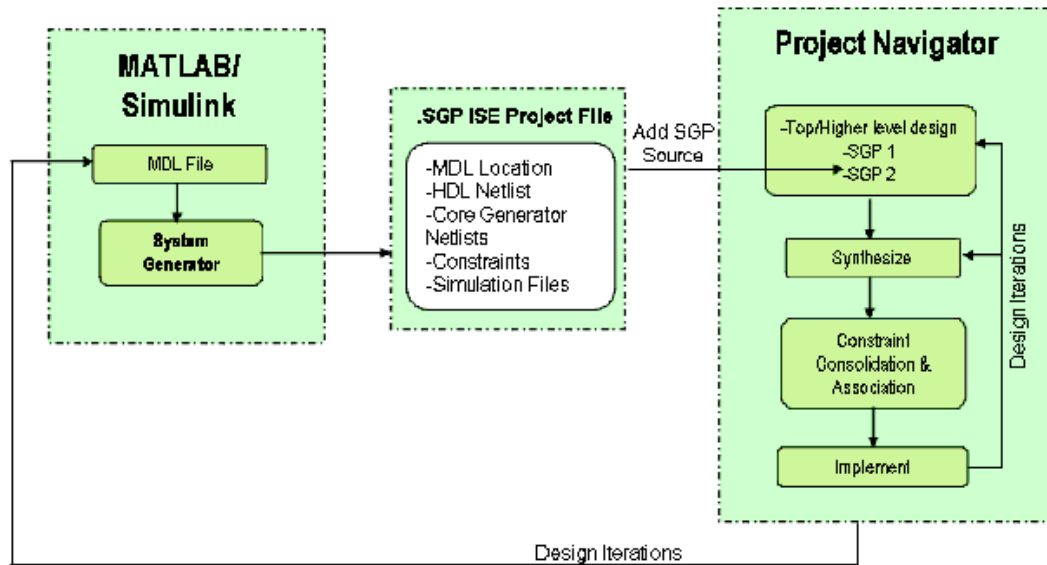

## A Step-by-Step Example

In this example, two HDL netlists from System Generator are integrated into a larger VHDL design. Design #1 is named SPRAM and design #2 is named MAC\_FIR. The top-level VHDL entity combines the two data ports and a control signal from the SPRAM design to create a bidirectional bus. The top-level VHDL also instantiates the MAC\_FIR design and supplies a separate clock signal named clk2. A block diagram of this design is shown below.

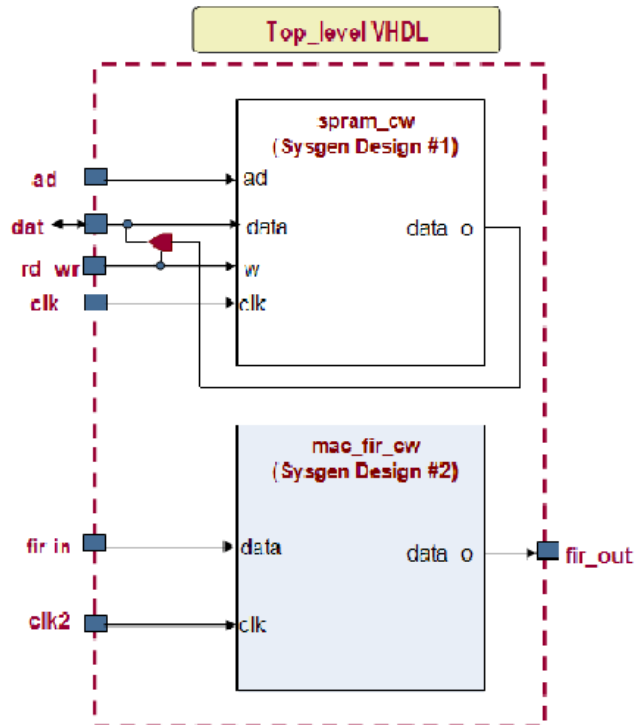

The files used in this example are located in the System Generator tree at pathname `<ISE_Design_Suite_tree>/sysgen/examples/projnav/mult_diff_designs`. The following files are provided:

- `spram.mdl` - System Generator design #1
- `mac_fir.mdl` - System Generator design #2

Files within the sub-directory named `top_level`:

- `top_level.ise` - ProjNav project for compiling top\_level design
- `top_level.vhd` - Top-level VHDL file
- `top_level_testbench.do` - Custom ModelSim .do file
- `top_level_testbench.vhd` - Top-level VHDL testbench file
- `wave.do` - ModelSim .do file called by `top_level_testbench.do` to display waveforms

## Generating the HDL Files for the System Generator Designs

The steps used to create the HDL files are as follows:

1. Open the first design, `spram.mdl`, in MATLAB. This is a multirate design due to the down sampling block placed after the output of the Single Port RAM.
2. Double click on the System Generator token; select the HDL Netlist target and press the **Generate** button. By pressing the **Generate** button, the HDL file for this design is created in the directory  
`<ISE_Design_Suite_tree>/sysgen/examples/projnav/mult_diff_designs/hdl_netlist1.`
3. Repeat steps 1 and 2 for the `mac_fir.mdl` model. The HDL file for this design is created in the directory  
`<ISE_Design_Suite_tree>/sysgen/examples/projnav/mult_diff_designs/hdl_netlist2.`

**Note:** You are now finished generating HDL Netlists from System Generator

## Switching to Different HDL Libraries

When integrating two or more System Generator designs into a bigger design, you need to rename HDL libraries to prevent name clashes and other undesired behaviors during simulation. System Generator provides a utility that switches library names for all related files in your System Generator design. In addition, it also makes a backup copy in a folder just in case you want to revert back to the original library name. The following is the syntax for this utility:

**Syntax:**

```
xlSwitchLibrary(<target_dir_pathname>, <from_lib_name>, <to_lib_name>)
```

<target\_dir\_pathname>: location of the design

<from\_lib\_name>: Original HDL library name

<to\_lib\_name>: New HDL library name

1. From the MATLAB Console, enter the following command:  
`xlSwitchLibrary('hdl_netlist1', 'work', 'design1_lib')`
2. Next, from the MATLAB Console, enter the following command:  
`xlSwitchLibrary('hdl_netlist2', 'work', 'design2_lib')`



The transcript should look similar to the following:

```
>> xlSwitchLibrary('hdl_netlist1','work','design1_lib')
INFO: Switching HDL library references in design 'spram_cw' ...
INFO: A backup of the original files can be found at 'C:/Xilinx/12.1_ISE_DS/ISE/s
INFO: Processing file 'spram.vhd' ...
INFO: Processing file 'spram_cw.vhd' ...
INFO: Processing file 'isim_spram.prj' ...
INFO: Processing file 'xst_spram.prj' ...
INFO: Processing file 'vcom.do' ...
INFO: Processing file 'vsim.do' ...
INFO: Processing file 'pn_behavioral.do' ...
INFO: Processing file 'pn_posttranslate.do' ...
INFO: Processing file 'pn_postmap.do' ...
INFO: Processing file 'pn_postpar.do' ...
>> xlSwitchLibrary('hdl_netlist2','work','design2_lib')
INFO: Switching HDL library references in design 'mac_fir_cw' ...
INFO: A backup of the original files can be found at 'C:/Xilinx/12.1_ISE_DS/ISE/s
INFO: Processing file 'mac_fir.vhd' ...
INFO: Processing file 'mac_fir_cw.vhd' ...
INFO: Processing file 'isim_mac_fir.prj' ...
```

## Adding System Generator Source into the Top-Level Design

The next two steps are used to synthesize the top\_level design:

1. Launch ISE and reload the pre-generated top-level design ISE project at ~top\_level/top\_level.ise.

**Note:** At this point, your Project Navigator should look like the figure below. Both spram\_cw and mac\_fir\_cw instances are instantiated at the top\_level design. But since they are not located on the same directory as the top-level design, Project Navigator puts a question mark next to each one of them to indicate that it can not find these two instances / modules.

:

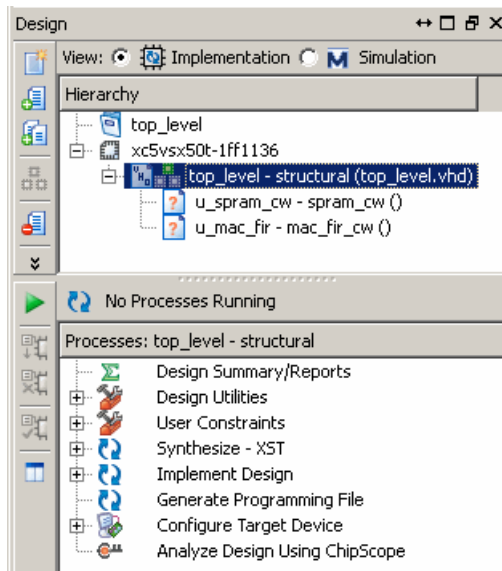

2. Add the System Generator source: under the **Sources** tab, right-click on **u\_spram\_cw** -> **Add Source...** at <ISE\_Design\_Suite\_tree>/sysgen/examples/projnav/mult\_diff\_designs/hdl\_netlist1/spram\_cw.sgp

3. Repeat item 2 with **u\_mac\_fir** at  
`<ISE_Design_Suite_tree>/sysgen/examples/projnav/mult_diff_designs/hdl_netlist2/mac_fir_cw.sgp`
4. As shown below, make sure the file `top_level` is selected, then implement the design by double clicking on **Implement Design** in the Processes window. Once the implementation is finished, Project Navigator should look like the figure below.

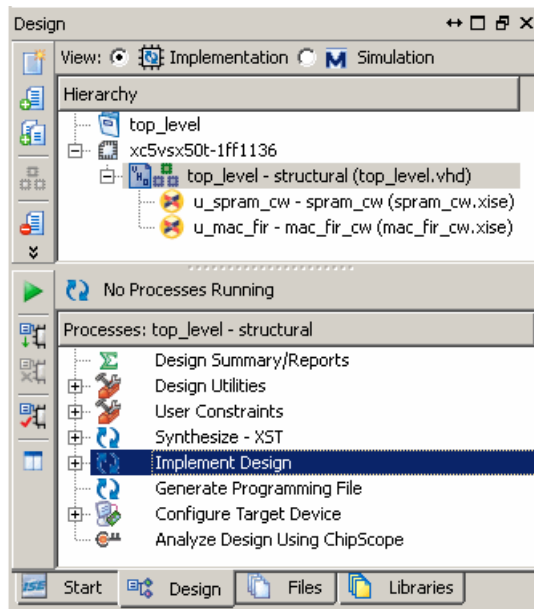

5. Examine the timing constraints in the **Place and Route Report** that is located in the Detailed Reports section of the Design Summary pane.

Note that in the PAR report the multirate constraints were met:

	Constraint	Check	Worst Case Slack	Best Case Achievable	Timing Errors	Timing Score
①	TS_clk_f488215c2 = PERIOD TIMEGRP "clk_f488215c2" 100 ns HIGH 50%	SETUP	96.334ns   0.309ns	3.666ns	0   0	0
②	TS_clk_c4b7e2441 = PERIOD TIMEGRP "clk_c4b7e2441" 100 ns HIGH 50%	SETUP	96.366ns   0.063ns	3.634ns	0   0	0
③	TS_ce_16_c4b7e244_group1 = MAXDELAY FROM TIMEGRP "ce_16_c4b7e244_group1" TO TIMEGRP "ce_16_c4b7e244_group1" 1600 ns	SETUP	1597.868ns   0.106ns	2.132ns	0   0	0
④	TS_ce_2_f488215c_group2 = MAXDELAY FROM TIMEGRP "ce_2_f488215c_group2" TO TIMEGRP "ce_2_f488215c_group2" 200 ns	N/A	N/A	N/A	N/A	N/A

Constraints for each System Generator design were created and translated to a UCF (User Constraint File). These UCF constraint files were then consolidated and associated during ISE implementation (NGDBUILD). They are briefly described as follows:

A system sample period of 100 ns was set in the System Generator token for both designs (1 & 2)

- TS\_clk\_f488215c2 constraints are from the SRAM design (1)

- The TS\_clk\_c4b7e2441 constraints are from the FIR design (2)
- The ce16\_c4b7e244\_group\_to\_ce16\_cb47e244\_group1 constraint is for all the synchronous elements after the down sampler and it is set to sixteen, the system sample period (3)
- The down sampling block in the SRAM design performs a down sample by 2. The ce2\_f488215c\_group\_to\_ce2\_f488215c\_group2 constraint is for all the synchronous elements after the down sampler and is set to twice the system sample period (4)

With the new integration between System Generator and Project Navigator, these constraints are automatically associated and consolidated by Project Navigator up to the top-level design. This flow is only available starting with Release 10.1.

## Simulating the Entire Design

To perform a behavioral simulation of the top\_level design, do the following:

1. System Generator creates VHDL files and invokes the selected logic synthesis tool to generate the HDL Netlist. These VHDL files are used when simulating the top-level design. The VHDL files generated for a design are named <design>\_cw.vhd, and <design>.vhd. Open the custom ModelSim do file named "top\_level\_testbench.do" to see how the VHDL files for both designs are referenced.

Memory initialization (.mif) and coefficient (.coe) files that are used during simulation must be placed in the same directory as the top-level VHDL file. For this example, the mif files are copied from both hdl\_netlist1 and hdl\_netlist2 sub-folders by the following statement in the ModelSim do file (top\_level\_testbench.do):

```
foreach i [glob ../hdl_netlist1/*.*mif] {
file copy -force $i .
```

In a case where there are also coefficient files, you can add a similar statement to the do file to copy the files up to the top-level VHDL file.

2. Change the Design View to **Simulation**. Select the **top\_level\_testbench-structural(top\_level.vhd)** source file. This file is imported into the project as a testbench file, thus allowing you to simulate the design using the Simulator.

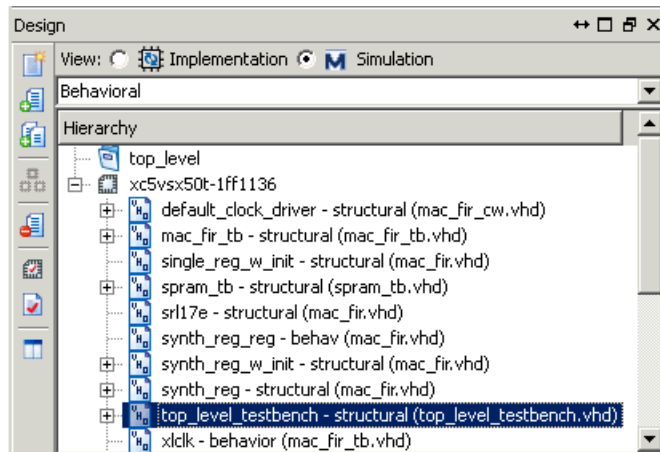

- In the Processes View, right click on **Simulate Behavioral Model** and select **Process Properties...** You should see a Simulation Properties dialog box as shown below. Note that a Custom Do File has been specified.

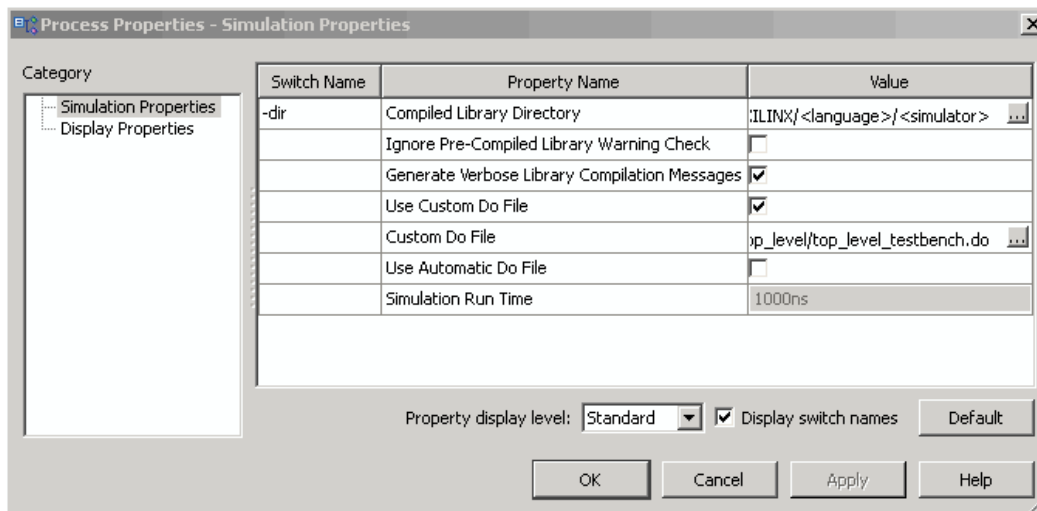

```
## NOTE: customer.do file
##
vlib design1_lib
vcom -explicit -93 -work design1_lib "../hdl_netlist1/spram.vhd"
vcom -explicit -93 -work design1_lib "../hdl_netlist1/spram_cw.vhd"
vlib design2_lib
vcom -explicit -93 -work design2_lib "../hdl_netlist2/mac_fir.vhd"
vcom -explicit -93 -work design2_lib "../hdl_netlist2/mac_fir_cw.vhd"
vlib work
vcom -explicit -93 top_level.vhd
vcom -explicit -93 top_level_testbench.vhd
foreach i [glob ../hdl_netlist1/*.mif] {
    file copy -force $i .
}
foreach i [glob ../hdl_netlist2/*.mif] {
    file copy -force $i .
}
vsim -t 1ps -lib work top_level_testbench
do wave.do
run 10000ns
```

The previous screen shot shows the ModelSim commands used to compile the VHDL code generated by System Generator. To simulate the top\_level design, double left click on the **Simulate Behavioral Model** process. The ModelSim .do file compiles the VHDL code and runs the simulation for 10000 ns. The resulting waveform is shown below.

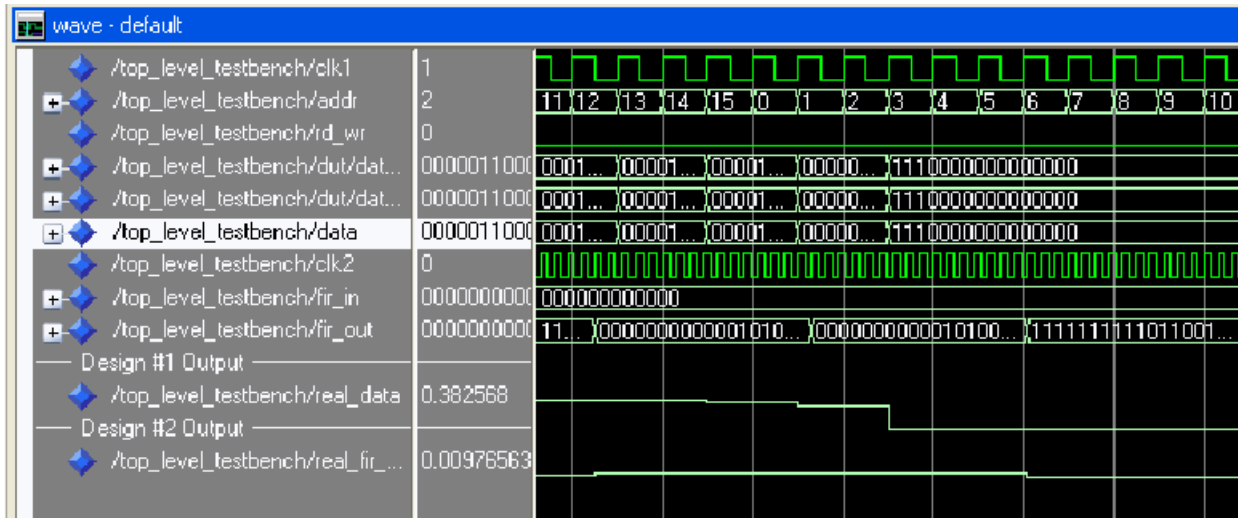

## Summary

This topic has shown you how to import a System Generator Design into a larger system. There are a few important things to keep in mind during each phase of the process.

While creating a System Generator design:

- IOB constraints should not be specified on Gateways in the System Generator model; neither should the System Generator token specify a clock pin location.
- Use the **HDL Netlist** compilation target in the System Generator token. The HDL Netlist file that System Generator produces contains both the RTL, EDIF and constraint information for your design.

For top-level simulation:

- Create a custom ModelSim .do file in order to compile the VHDL files created by System Generator. Modify the Project Navigator settings to use this custom .do file

New capabilities:

- Add System Generator Source type project file (.sgp) into Project Navigator as a sub-module design
- Consolidate and associate System Generator constraints into the top-level design
- Launch MATLAB and System Generator MDL directly from Project Navigator to perform certain design iterations

## Generating a PlanAhead Project File from System Generator

Starting with Xilinx ISE Design Suite 13.3, you can now generate a PlanAhead project file (PPR file) from within System Generator using either an HDL Netlist or Bitstream compilation type and invoke PlanAhead using the generated file. In addition, you can iterate a design between PlanAhead and System Generator by using different Synthesis and Implementation strategies. This eliminates the need for you to manually port individual HDL files into a PlanAhead project. Currently, System Generator only supports the project file generator for a top-level design.

### Step-by-Step Example for Generating a PlanAhead Project File

This example illustrates how to generate a PlanAhead project file from within System Generator. The design comes from the System Generator examples directory.

#### Shared Memory 5x5 Reloadable Filter Operator Example

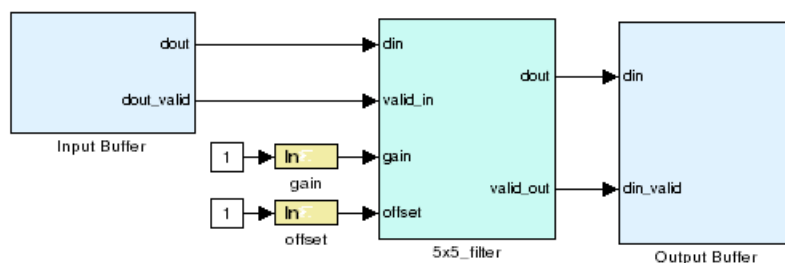

1. Launch Xilinx System Generator and from the MATLAB console navigate to the System Generator examples directory at the following path:  
`<ISE tree>/sysgen/examples/shared_memory/hardware_cosim/con5X5_video`
2. Open the file `conv5X5_video_ex.mdl`, then double click on the System Generator Token.

- Set the parameters in the dialog box as follows:

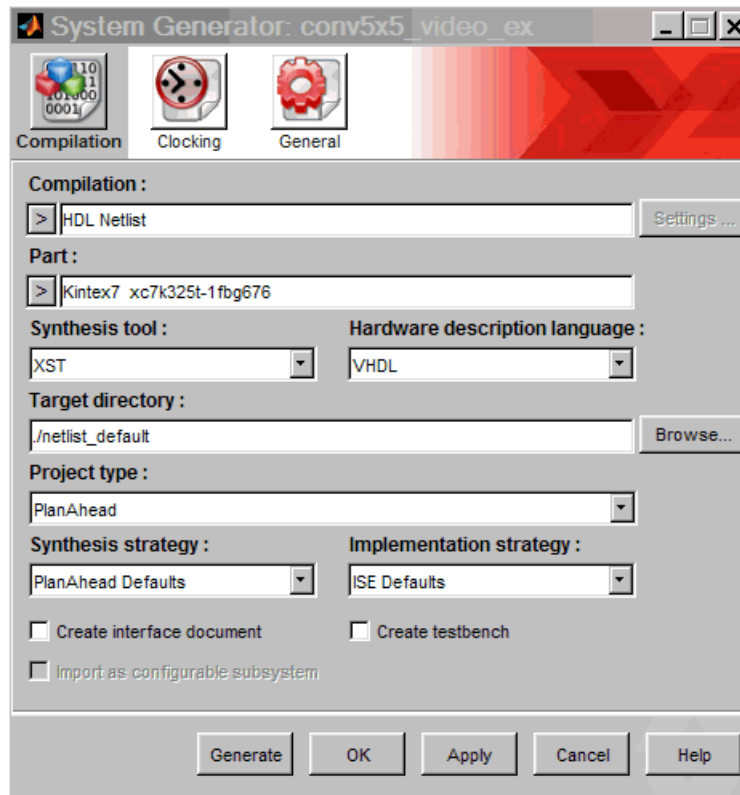

**Note:** Both the Synthesis and Implementation strategies are set to defaults; PlanAhead Defaults and ISE Defaults respectively. These strategy options are only available when the Compilation setting is set to either HDL Netlist or Bitstream and the Project type is PlanAhead. In other iterations, you can choose a different strategy from the dropdown lists.

- Click **Generate** to generate the netlist files and the PlanAhead project file (PPR file).
- From the MATLAB console, navigate to the sub-folder `netlist_default/hdl_netlist`, right click on the file `conv5x5_video_ex_cw.ppr` and select **Open Outside MATLAB**.

- Observe in the PlanAhead Project Summary pane that the Design strategies are the same as that specified in the System Generator Token.

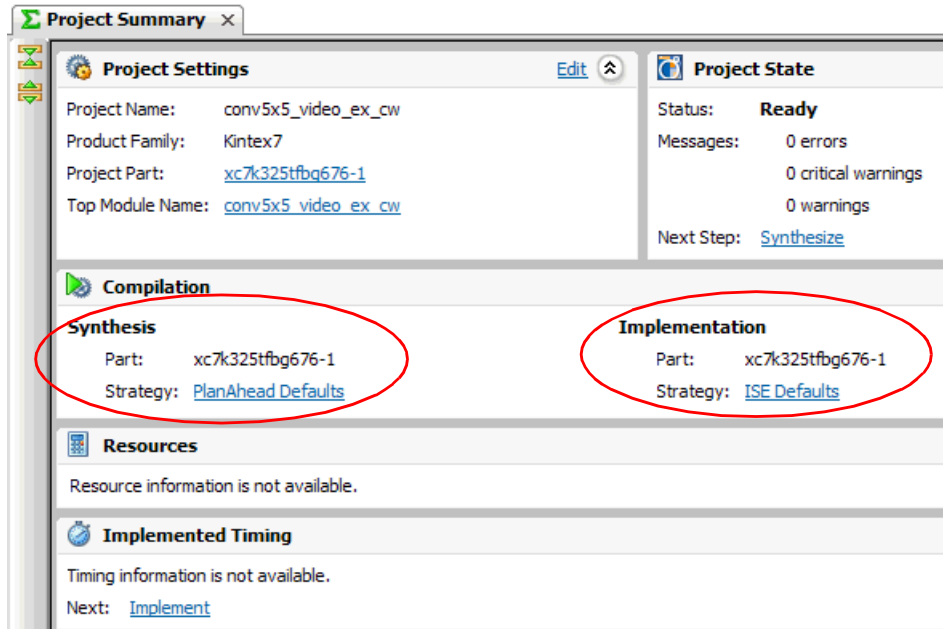

- Create a custom Synthesis strategy, by clicking on the PlanAhead Defaults strategy in the Project Summary report (as shown above).
- As shown below, right click on the Strategy name in the Project Settings dialog box and select **Save As**.

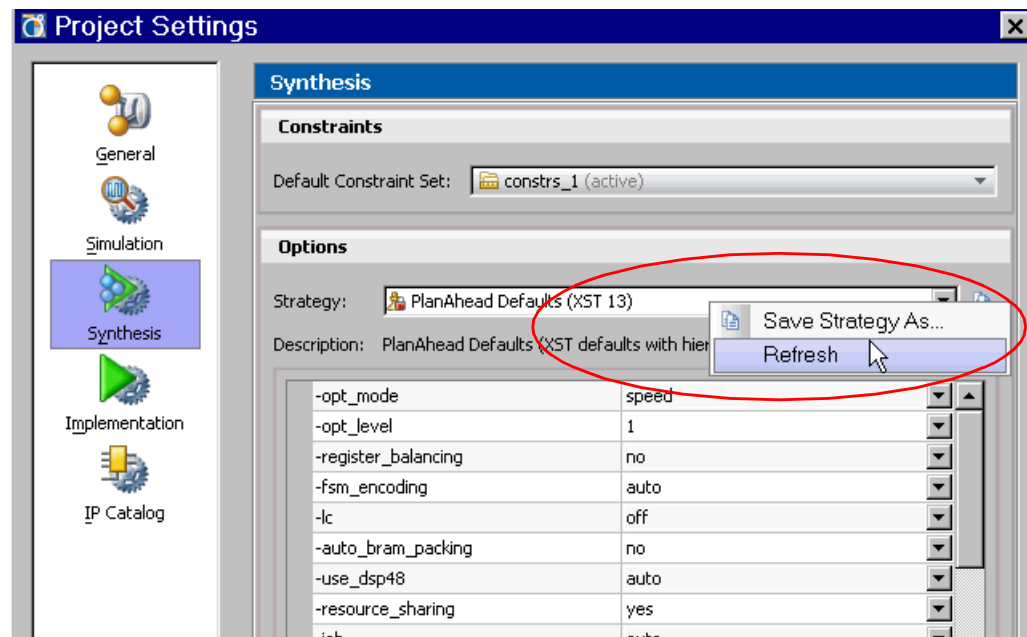

- Enter a new name such as **custom\_conv5X5\_video**. Change the `-opt_mode` parameter from speed to area, click **Apply** then click **OK**. Notice that the Synthesis strategy in the PlanAhead Summary window now says **custom\_conv5X5\_video**.
- Return to the open `conv5X5_video_ex.mdl` design in the MATLAB environment and double-click on the System Generator token.



11. Select PlanAhead in the Project type field and notice that the Synthesis strategy is now automatically specified as **custom\_conv5X5\_video**.

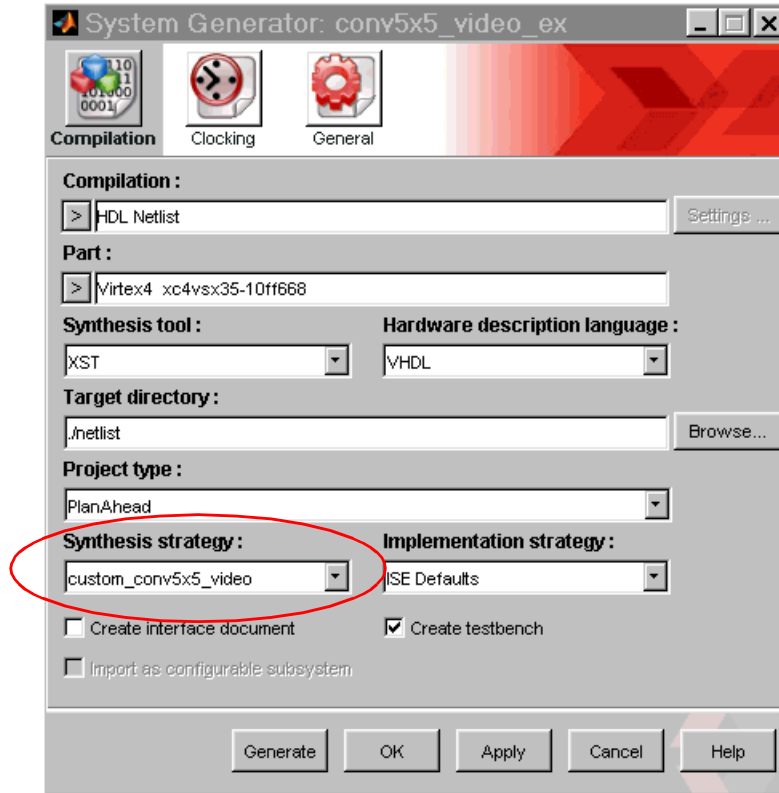

## Importing a System Generator Design into PlanAhead

Starting with ISE Design Suite 14.1, you can import an existing System Generator design into PlanAhead. The model can be added to any hierarchy level as a sub-module or imported as the top-level design. Another possibility is to invoke System Generator from within PlanAhead and create a new System Generator module.

The procedure below describes how to import a known good algorithm from System Generator into PlanAhead. After import, you may want to modify the System Generator design and verify the algorithm with Simulink all inside of PlanAhead.

### Steps to Import a System Generator Design as a Sub-Module

**Note:** The files described below are located in the System Generator examples folder named `planahead/sysgen_import`.

1. Open a PlanAhead project and add a file named `top_level.vhd` as the structural Top-level source file.
2. Add an existing System Generator design named `rgb2grey.mdl` as a sub-module in the PlanAhead Sources window. Right-click on `top_level` structural, select **Add Sources > Add or Create DSP Source > Add Sub-Design...** Navigate to the `rgb2grey.mdl`, select the file and click **OK**, then **Finish**.
3. After the `rgb2gray` model is added, right-click on it in the PlanAhead Sources window and select **Open File**. This will invoke MATLAB and open the System Generator model.
4. Simulate the model to make sure the output simulation results match those provided as references in the `top_level.vhd`
5. Close the model and exit MATLAB
6. Now you ready to generate an HDL netlist from the System Generator model. Right-click on the `rgb2grey.mdl` file and select **Generate Output Products...**

**Note:** Note: It will take approximately 3–5 minutes to generate. Once the netlist generation is finished, you should see a hierarchical tree showing up under the `rgb2grey` model.

7. The `top_level.vhd` file already contains a component and instance of the `rgb2gray_cw` for your convenience but you can easily add them yourself by using View Instantiation Template.
8. At this point, your Design Sources should look similar to the figure below:

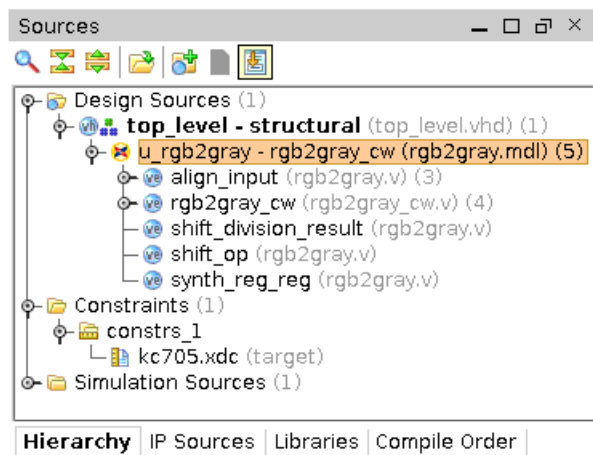

## Creating a New System Generator Design from within PlanAhead

1. Create a new PlanAhead project by selecting an RTL Project type and targeting the XC7K325TFFG900-2 device. Click through the Add Sources, Add Existing IP, and Add Constraints popup windows. Basically you just created an empty project file with no source files.
2. Right-click on **Design Sources > Add Sources... > Add or Create DSP Sources**
3. In the Add Sources window, select **Add Files** to add a System Generator `rgb2grey.mdl` model located in the System Generator examples folder under `planahead/sysgen_import`, then click **Finish**.
4. Repeat the above step to add a constraint file named `kc705.xdc`
5. Generate an HDL netlist from the System Generator model by right-clicking on `rgb2grey.mdl` in the PlanAhead Sources window and select **Generate...**

**Note:** At this point, the Design Sources should look similar to the figure below

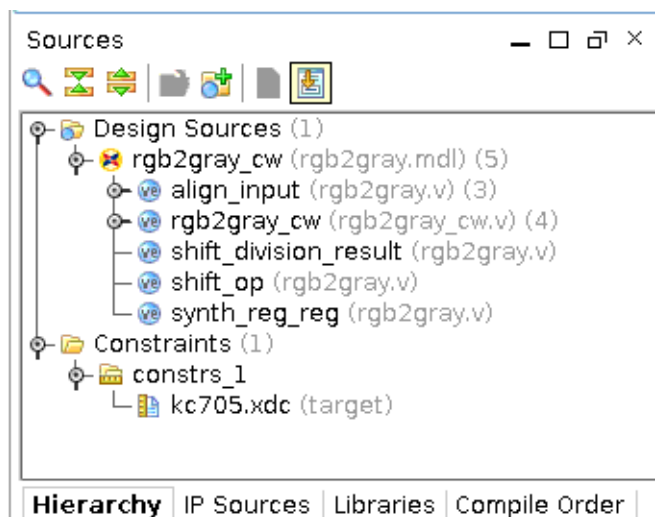

6. Now create a top-wrapper or top-level design for the `rgb2gray_cw` instance. Right-click on `rgb2gray_cw (rgb2gray.mdl)` and select **Create Top HDL**.

You should now see a top-wrapper Verilog file named `rgb2gray_cw_stub` being created by PlanAhead. This feature is useful even if you are an HDL coder.

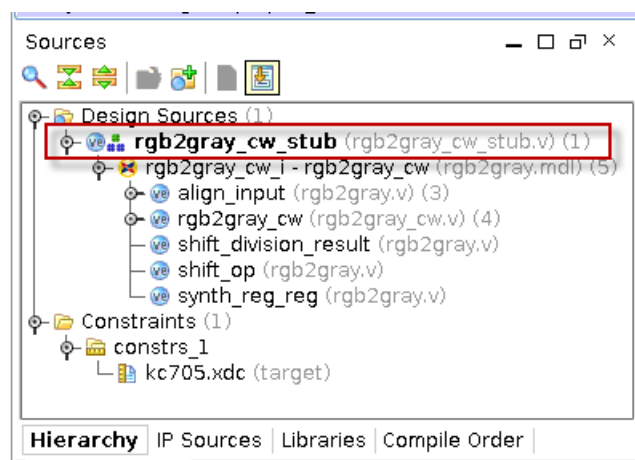

## Configurable Subsystems and System Generator

A configurable subsystem is a kind of block that is made available as a standard part of Simulink. In effect, a configurable subsystem is a block for which you can specify several underlying blocks. Each underlying block is a possible implementation, and you are free to choose which implementation to use. In System Generator you might, for example, specify a general-purpose FIR filter as a configurable subsystem whose underlying blocks are specific FIR filters. Some of the underlying filters might be fast but require much hardware, while others are slow but require less hardware. Switching the choice of the underlying filter allows you to perform experiments that trade hardware cost against speed.

### Defining a Configurable Subsystem

A configurable subsystem is defined by creating a Simulink library. The underlying blocks that implement a configurable subsystem are organized in this library. To create such a library, do the following:

- Make a new empty library.

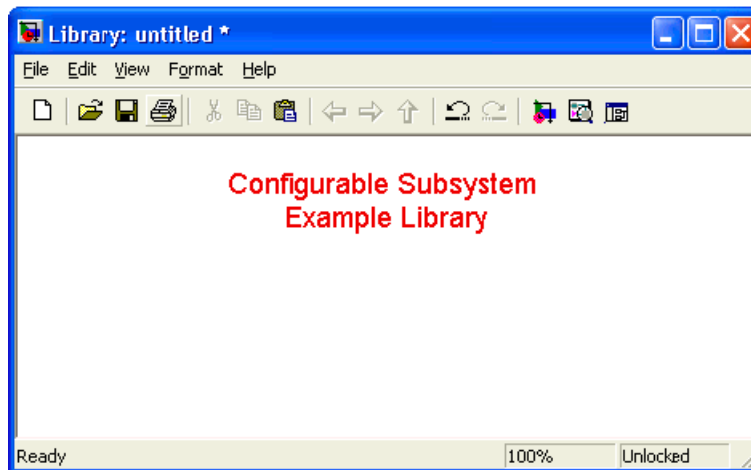

- Add the underlying blocks to the library.

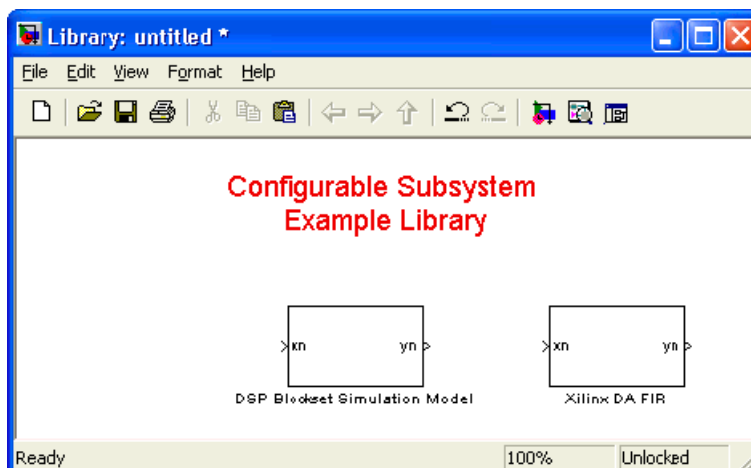

- Drag a template block into the library. (Templates can be found in the Simulink library browser under Simulink/Ports & Subsystems/Configurable Subsystem.)

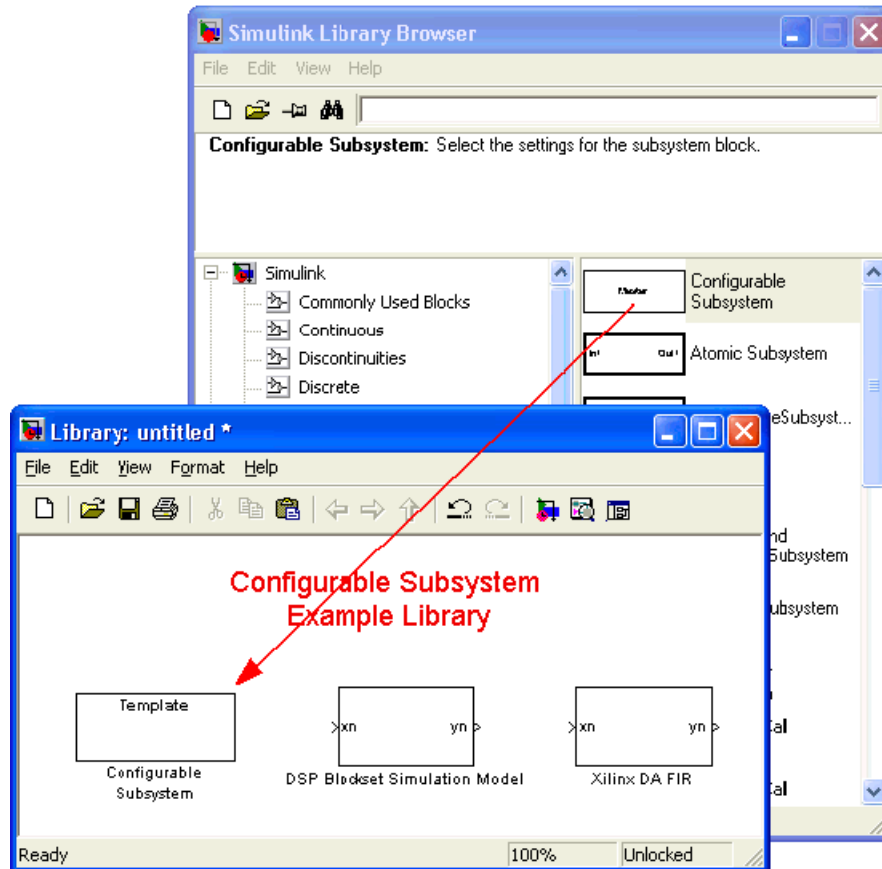

- Rename the template block if desired.
- Save the library.
- Double click to open the template for the library.
- In the template GUI, turn on each checkbox corresponding to a block that should be an implementation.

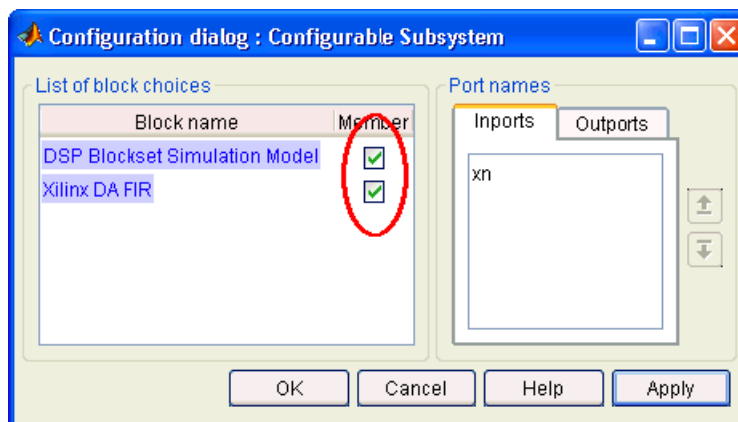

- Press **OK**, and then save the library again.

## Using a Configurable Subsystem

To use a configurable subsystem in a design, do the following:

- As described above, create the library that defines the configurable subsystem.
- Open the library.
- Drag a copy of the template block from the library to the appropriate part of the design.
- The copy becomes an instance of the configurable subsystem.

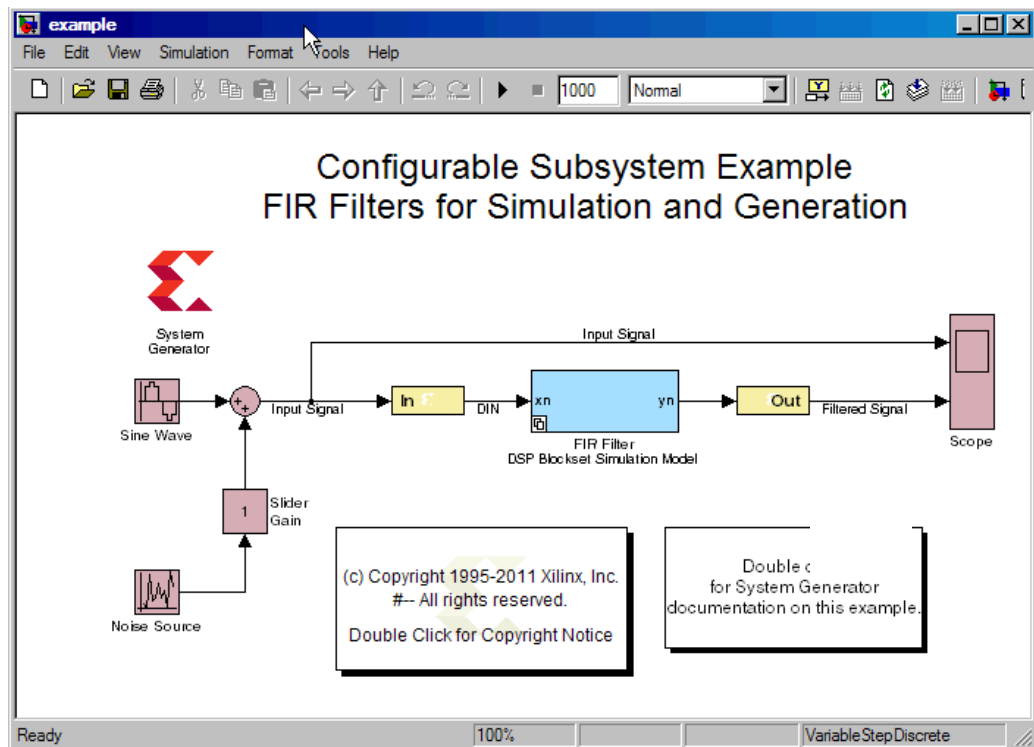

- Right-click on the instance, and under **Block choice** select the block that should be used as the underlying implementation for the instance.

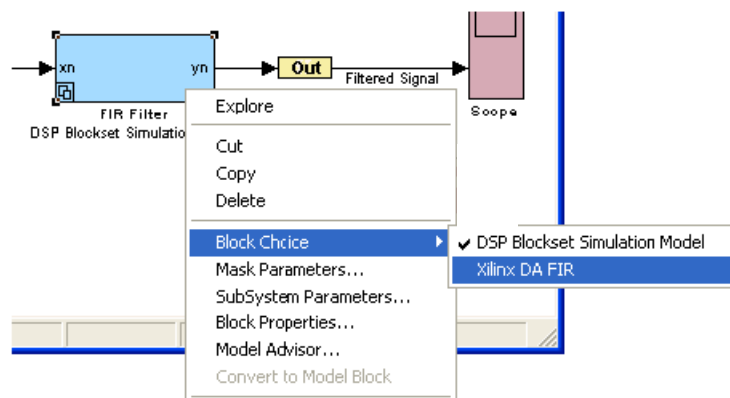

## Deleting a Block from a Configurable Subsystem

To delete an underlying block from a configurable subsystem, do the following:

- Open and unlock the library for the subsystem.
- Double click on the template, and turn off the checkbox associated to the block to be deleted.
- Press **OK**, and then delete the block.

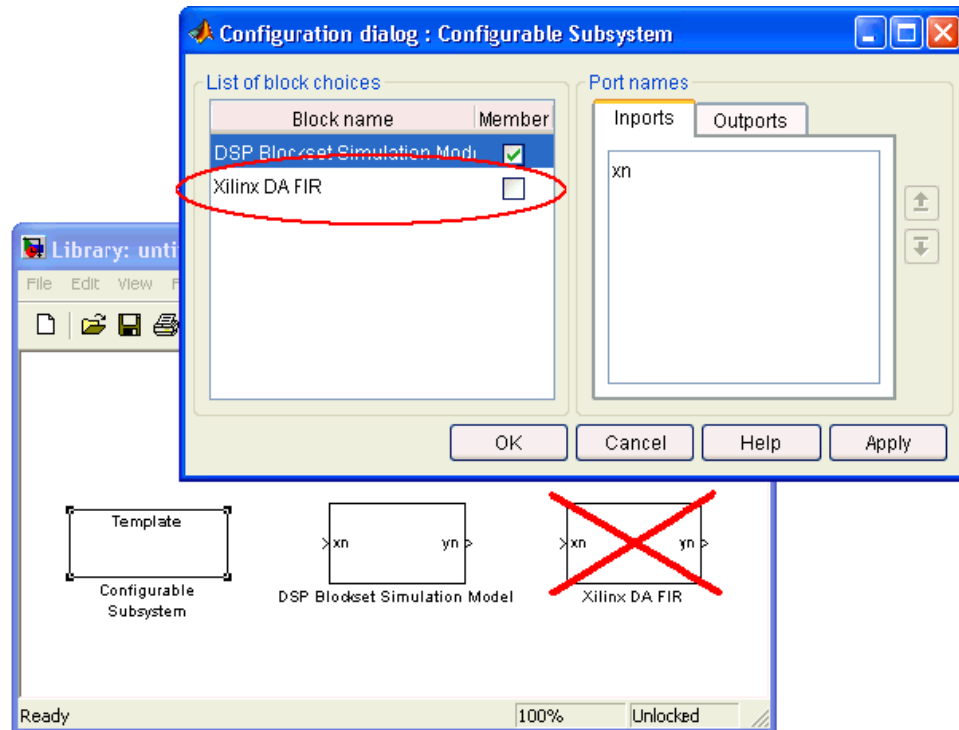

- Save the library.
- Compile the design by typing Ctrl-d.
- If necessary, update the choice for each instance of the configurable subsystem.

## Adding a Block to a Configurable Subsystem

To add an underlying block to a configurable subsystem, do the following:

- Open and unlock the library for the subsystem.
- Drag a block into the library.

- Double click on the template, and turn on the checkbox next to the added block.

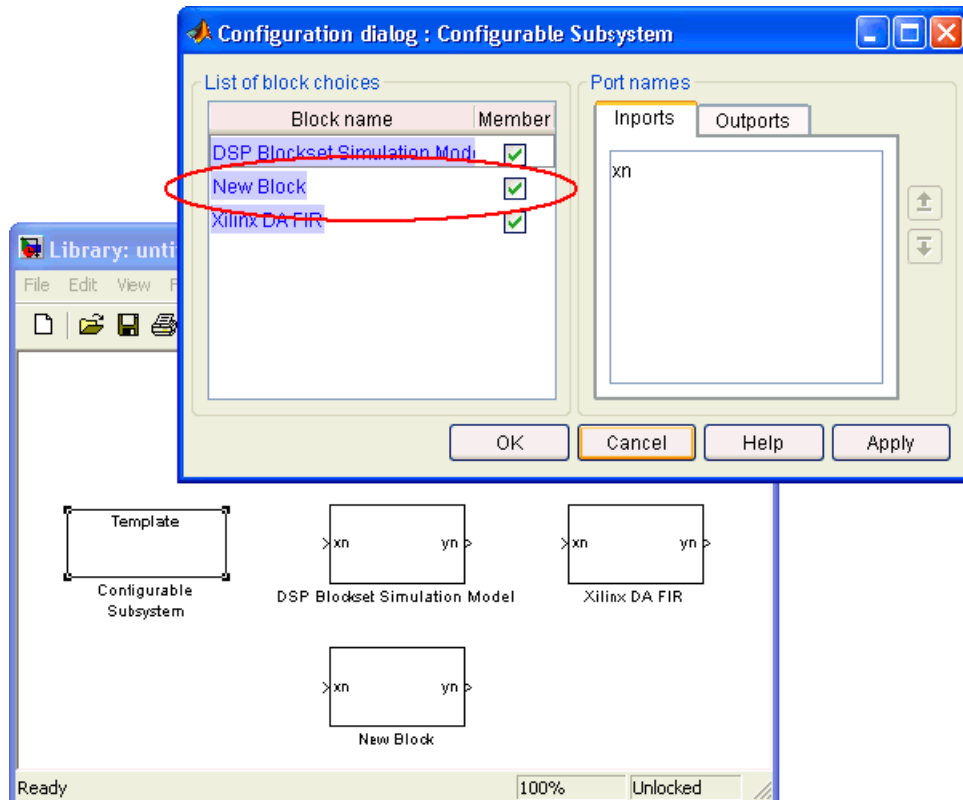

- Press **OK**, and then save the library.
- Compile the design by typing Ctrl-d.
- If necessary, update the choice for each instance of the configurable subsystem.

## Generating Hardware from Configurable Subsystems

In System Generator, blocks both participate in simulations and produce hardware. Sometimes, for a configurable subsystem, it is worthwhile to use one underlying block for simulation, but use another for hardware generation. For example, it might make sense to use ordinary System Generator blocks to produce simulation results, but use a black box to supply the corresponding HDL. The System Generator configurable subsystem manager block makes this possible; the ordinary block choice for the configurable subsystem is used when simulating, and the block specified in the manager is used for hardware generation.

To use a configurable subsystem manager, do the following:

- Open and unlock the library for the configurable subsystem.
- Select one of the blocks in the library, and double click to open it. (Aside from the template any block will do, provided the block is itself a subsystem. If there is no such subsystem in the library, it is not possible to use a configurable subsystem manager.)



- Drag a manager block into the subsystem opened above. (The manager block can be found in Xilinx Blockset/Tools/Configurable Subsystem Manager).

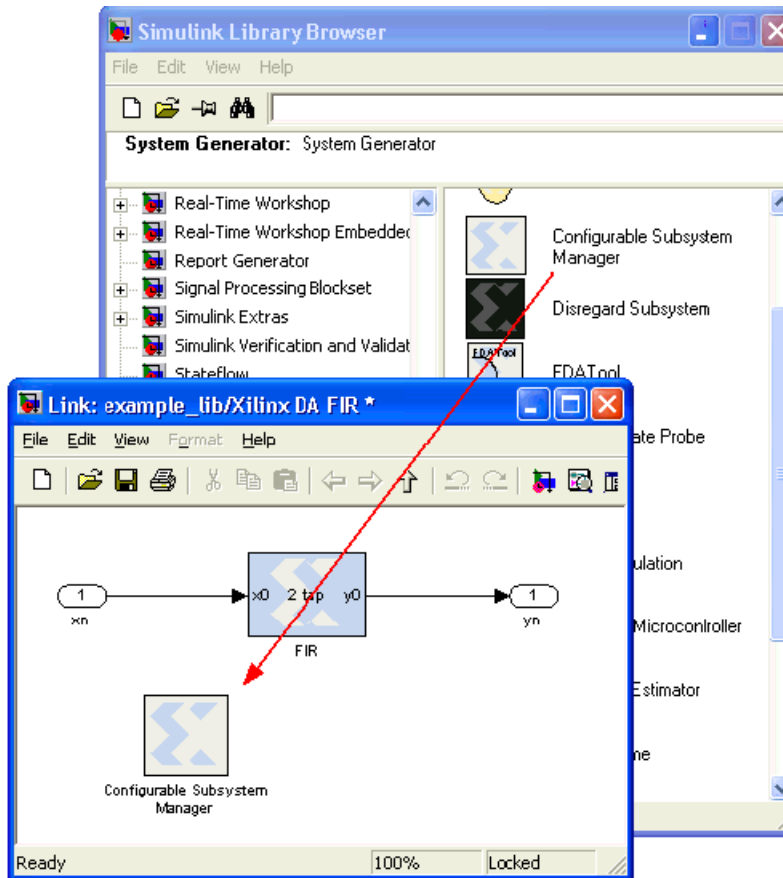

- Double click to open the GUI on the manager, then select the block that should be used for hardware generation in the configurable subsystem.

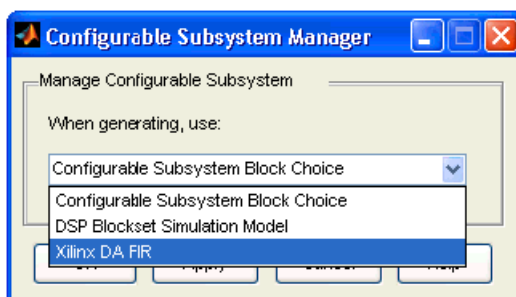

- Press **OK**, then save the subsystem, and the library.

The MathWorks description of configurable subsystems can be found the following address:

<http://www.mathworks.com/access/helpdesk/help/toolbox/simulink/slref/configurablesubsystem.shtml>.

## Notes for Higher Performance FPGA Design

If you focus all your optimization efforts using the back-end implementation tools like MAP and PAR, you may not be able to achieve timing closure because of the following reasons:

- The more complex IP blocks in a System Generator design like FIR Compiler and FFT are generated by CORE Generator under the hood. They are provided as highly-optimized NGC netlists to the synthesis tool and the implementation tools, so further optimization may not be possible.
- System Generator netlisting produces HDL code with many instantiated primitives such as registers, BRAMs, and DSP48s. There is not much a synthesis tool can do to optimize these elements.
- ISE SmartXplorer relies on previous optimization techniques applied in System Generator itself and on optimum RTL synthesis results.

The following tips focus on what you can do in System Generator to increase the performance of your design before you start the implementation process.

- [Review the Hardware Notes Included with Each Block Dialog Box](#)
- [Register the Inputs and Outputs of Your Design](#)
- [Insert Pipeline Registers](#)
- [Use Saturation Arithmetic and Rounding Only When Necessary](#)
- [Use the System Generator Timing and Power Analysis Tools](#)
- [Set the Data Rate Option on All Gateway Blocks](#)
- [Reduce the Clock Enable \(CE\) Fanout](#)
- [Experiment with Different Synthesis Settings](#)
- [Other Things to Try](#)

### Review the Hardware Notes Included with Each Block Dialog Box

Pay close attention to the Hardware Notes included in the block dialog boxes. Many blocks in the Xilinx Blockset library have notes that explain how to achieve the most hardware efficient implementation. For example, the notes point out that the Scale block costs nothing in hardware. By contrast, the Shift block (which is sometimes used for the same purpose) can use hardware.

### Register the Inputs and Outputs of Your Design

Register the inputs and outputs of your design. As shown below, this can be done by placing one or more Delay blocks with a latency 1 or Register blocks after the Gateway In

and before Gateway Out blocks. Selecting any of the Register block features adds hardware.

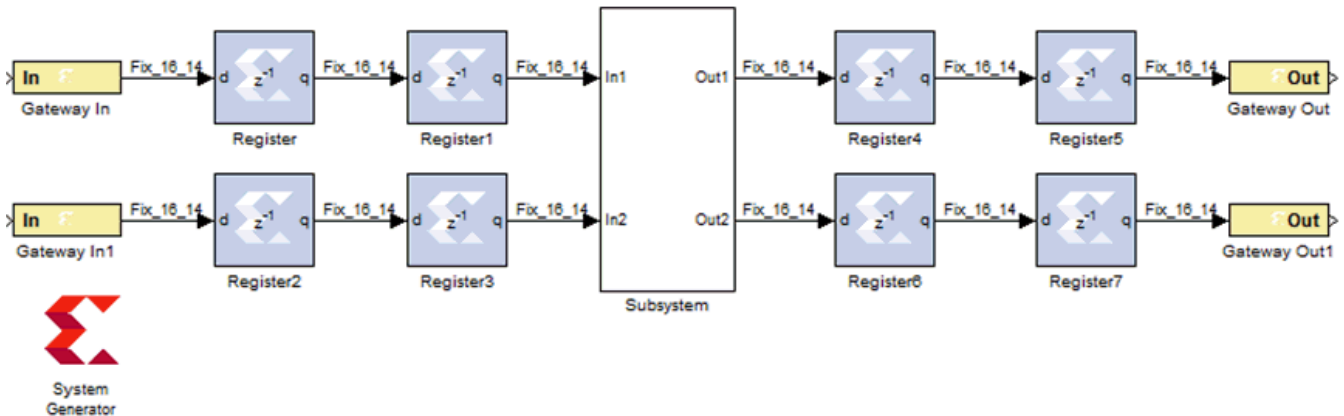

Double registering the I/Os may also be beneficial. This can be performed by instantiating two separate Register blocks, or by instantiating two Delay blocks, each having latency 1. This allows one of the registers to be packed into the IOB and the other to be placed next to the logic in the FPGA fabric. A Delay block with latency 2 does not give the same result because the block with a latency of 2 is implemented using an SRL16 and cannot be packed into an IOB.

### Insert Pipeline Registers

Insert pipeline registers wherever possible and reasonable. Deep pipelines are efficiently implemented with the Delay blocks since the SRL16 primitive is used. If an initial value is needed on a register, the Register block should be used. Also, if the input path of an SRL16 is failing timing, you should place a Register block before the related Delay block and reduce the latency of the Delay block by one. This allows the router more flexibility to place the Register and Delay block (SRL + Register) away from each other to maximize the margin for the routing delay of this path.

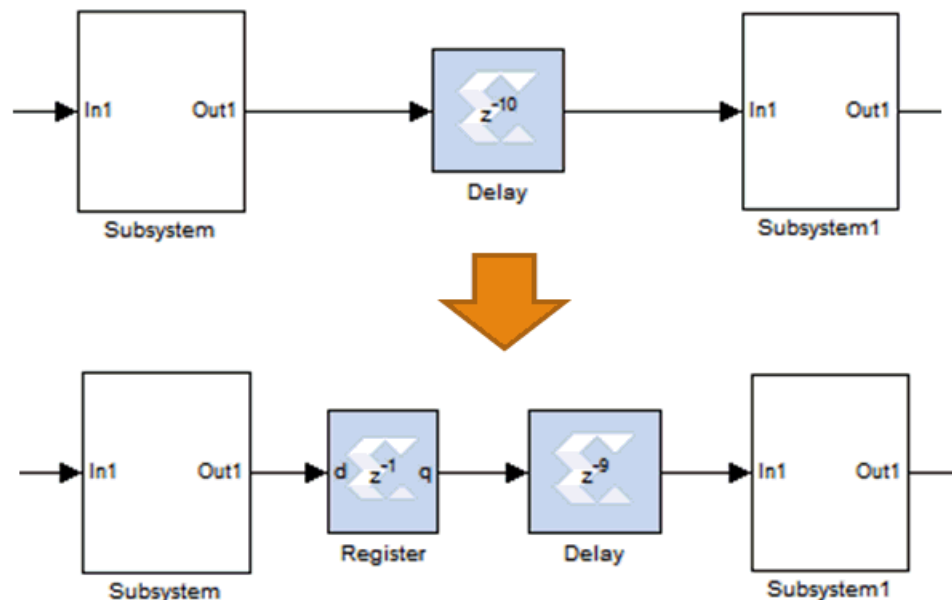

As shown below, the Convert block can be pipelined with embedded register stages to guarantee maximum performance.

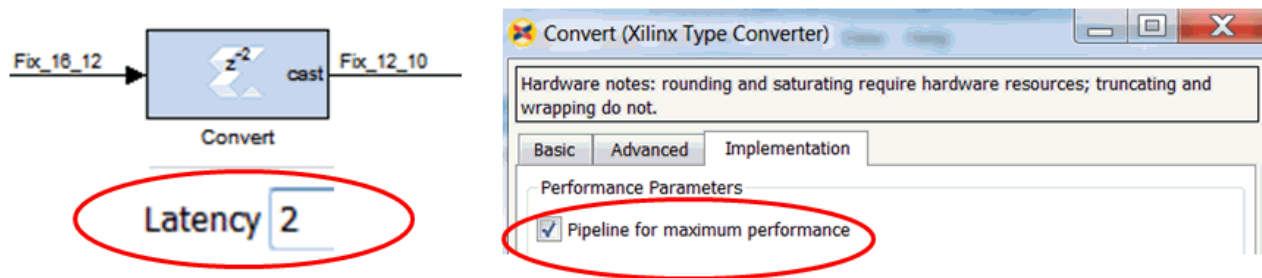

To achieve a more efficient implementation on some Xilinx blocks, you can select the **Implement using behavioral HDL** option. As shown below, if the delay on a Delay block is 32 or greater, Xilinx synthesis infers a SRLC32E (32-bit Shift-Register) which maps into a single LUT.

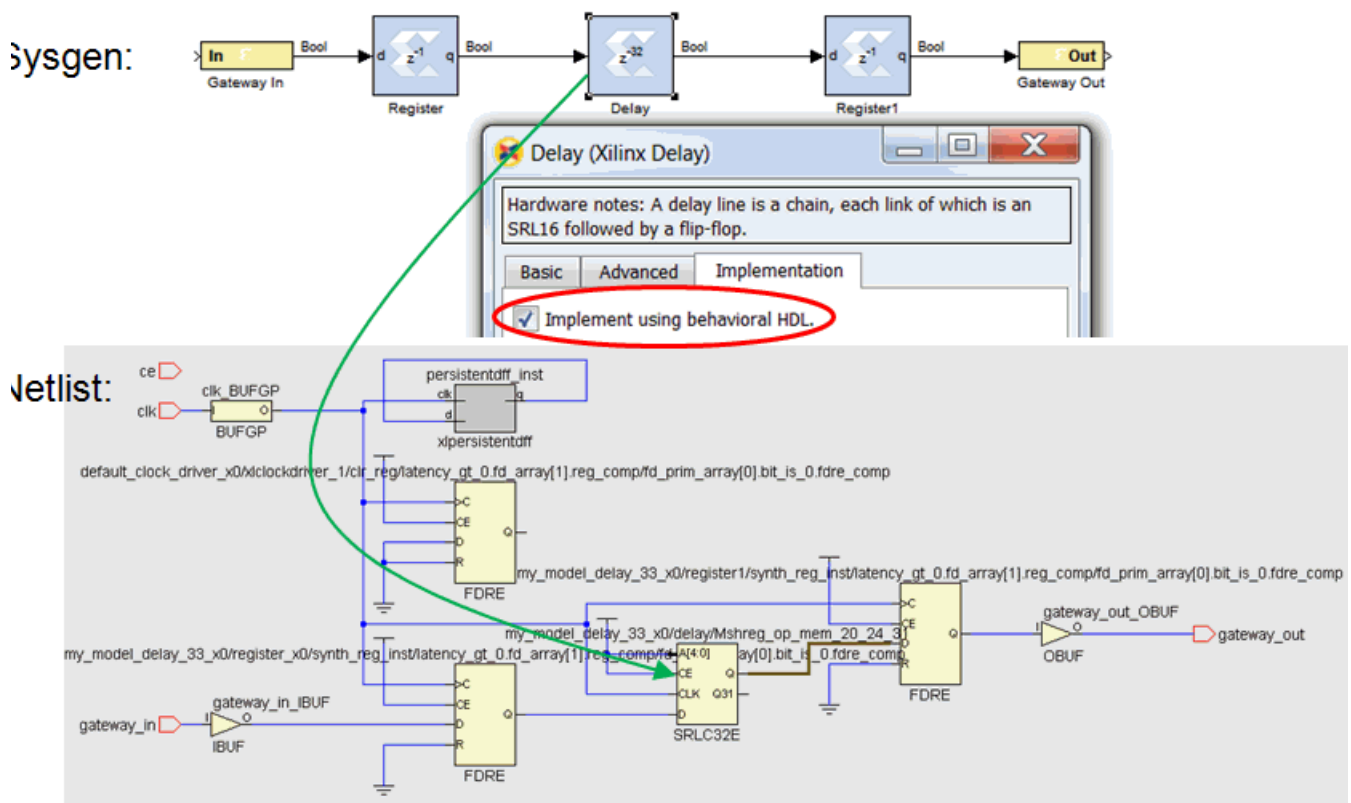

For BRAMS, use the internal output register. You do this by setting the latency from 1 (the default) to 2. This enables the BRAM output register.

When you are using DSP48s, use the input, output and internal registers; for FIFOs, use the embedded registers option. Also, check all the high-level IP blocks for pipelining options.

## Use Saturation Arithmetic and Rounding Only When Necessary

Saturation arithmetic and rounding have area and performance costs. Use only if necessary. For example a Reinterpret block doesn't cost any logic. A Convert (cast) block doesn't cost any logic if Quantization is set to Truncate and if Overflow is set to Wrap. If the data type requires the use of the Rounding and Saturation options, then pipeline the Convert block with embedded register stages. If you are using a DSP48, the rounding can be done within the DSP48.

## Use the System Generator Timing and Power Analysis Tools

If your System Generator design is to be included as a sub-module in a larger design, you should use the System Generator Timing and Power Analysis Tools to achieve timing closure before including the module in the larger design. If the System Generator design doesn't meet timing on its own, it is very unlikely that the module will meet timing when it is included in the larger design. It is much easier to identify and fix timing critical paths and parts of the design when doing timing closure on a module by module basis.

The timing analysis tool shows you the slowest paths and those paths which are failing to meet timing. The power analysis tool XPower can be used to provide a quick, less accurate analysis or a complete analysis using a full HDL simulation run. For more information, refer to topic [Timing and Power Analysis Compilation](#).

Before doing timing analysis, give subsystems, blocks from the Xilinx blockset as well as signals (wires) representative names. During the HDL netlisting process, SysGen preserves these instance and net names and you will be able to much easier trace back the failing paths listed in the Timing Report (TRW file) to the related instances and nets inside the System Generator design

## Set the Data Rate Option on All Gateway Blocks

Select the IOB timing constraint option **Data Rate** on all Gateway In and Gateway Out blocks. When **Data Rate** is selected, the IOBs are constrained at the data rate at which the IOBs operate. The rate is determined by the **Simulink system period(sec)** field in the System Generator token and the sample rate of the Gateway relative to the other sample periods in the design.

## Reduce the Clock Enable (CE) Fanout

An algorithm in the ISE® Mapper uses register duplication and placement based on recursive partitioning of loads on high fanout nets. This means improved FMAX on System Generator designs with large CE fanout.

Although this feature is enabled in System Generator by default, the fanout reduction occurs downstream during the ISE mapping operation and the following MAP options must be turned on:

- **Perform Timing-Driven Packing and Placement:** on
- **Map Effort Level:** High
- **Register Duplication:** on

If you are using the ISE Project Navigator flow, these MAP options are also on by default. However, if you are using a System Generator flow like Bitstream, you must turn on these MAP options by modifying the bitstream **OPT** file or by providing your own **OPT** file. See the topic [XFLOW Option Files](#) for more information.

## Experiment with Different Synthesis Settings

Try several implementations with different RTL synthesis options. You can use the automatically generated ISE project (.xise file within the System Generator **netlist** directory) and change the synthesis options there. If you are using XST, using **Read Cores**, **Optimize Instantiated Primitives** and the appropriate **Control Set** implementation settings can give better timing results.

## Other Things to Try

- **Change the Source Design**
  - ◆ **Use Additional Pipelining**  
Use the Output and Pipeline registers inside BRAM and DSP48s.
  - ◆ **Run Functions in Parallel**  
Run functions in parallel at a slower clock rate
  - ◆ **Use Retiming Techniques**  
Move existing registers through combinational logic.
  - ◆ **Use Hard Cores where Possible**  
Use Block RAM instead of distributed RAM.
  - ◆ **Use a Different Design Approach for Functions**
- **Avoid Over-Constraining the Design**  
Don't over-constrain the design and use up/down sample blocks where appropriate.
- **Consider Decreasing the Frequency of Critical Design Modules**
- **Squeeze Out the Implementation Tools**
  - ◆ **Try Different Synthesis Options.**
  - ◆ **Increase the MAP/PAR Effort Level**
  - ◆ **Use the SmartXplorer Tool**
  - ◆ **Floorplan Critical Modules**
- **Use a Faster Device**

# Processing a System Generator Design with FPGA Physical Design Tools

## HDL Simulation

System Generator creates custom .do files for use with your generated project and a ModelSim simulator. To use these files, you must have ModelSim. You may run your simulations from the standalone ModelSim tool, or you may associate it with the Xilinx ISE® Project Navigator, and run your simulations from within Project Navigator as part of the full software implementation flow.

## Compiling Your IP

Before you can simulate your design, you must compile your IP (cores) libraries with ModelSim.

## ModelSim SE

There are multiple ways to compile your IP libraries. Complete instructions for running compxlib can be found in the chapter titled COMPXLIB in the Command Line Tools User Guide.

From the Windows command line you can compile the necessary HDL libraries using the compxlib program. For example, the following command can be used to compile all the HDL libraries with ModelSim SE:

```
complib -s mti_se -f all -l all
```

## Simulation using ModelSim within Project Navigator

Before you can launch ModelSim from Project Navigator you must specify the location of your installed version of ModelSim. To do so, open Project Navigator and choose the main menu **Edit > Preferences**. This brings up a dialog box. Choose the **ISE General > Integrated Tools** category in the dialog box. Enter the full path to the version of ModelSim

on your PC in the Model Tech Simulator edit box. You must include the name of the executable file in this field.

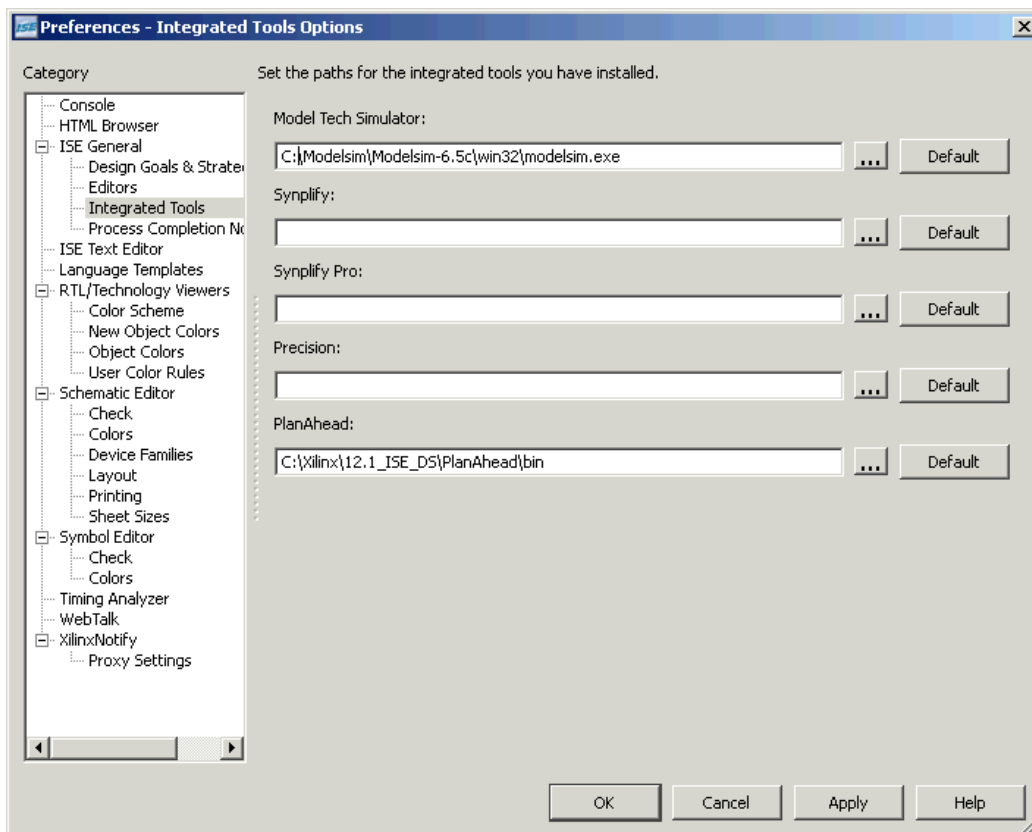

The Project Navigator project is already set up to run simulations at four different stages of implementation. System Generator creates four different ModelSim .do files when the Create Testbench option is selected on the System Generator token. The ModelSim do files created by System Generator are:

- `pn_behavioral.do` - for a behavioral (HDL) simulation on the HDL files in the project, before any synthesis or implementation.
- `pn_posttranslate.do` - this file runs a simulation on the output of the Xilinx translation (ngdbuild) step, the first step of implementation.
- `pn_postmap.do` - to run a simulation after your design has been mapped. This file also includes a back-annotated simulation on the post-mapped design.
- `pn_postpar.do` - to run a simulation after your design has been placed and routed. This file also includes a back-annotated simulation step.



In the Project Navigator **Design Simulation** view, you can use the pull-down menu to select Behavioral Simulation, Post-Translate Simulation, Post-Map Simulation, or Post-Route Simulation (corresponding to `pn_behavioral.do`, `pn_posttranslate.do`, `pn_postmap.do`, and `pn_postpar.do` respectively).

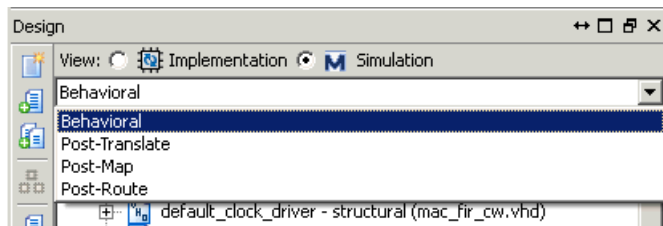

If you select the `<your design>_tb.vhd/.v` file in the Project Navigator **Design Simulation** view, the ModelSim Simulator will become available in the **Processes** view. Expand the ModelSim Simulator process by clicking on the plus button to the left of it. A simulation process associated with the ModelSim Simulator will appear (in the image below the process is labeled Simulate Behavioral Model).

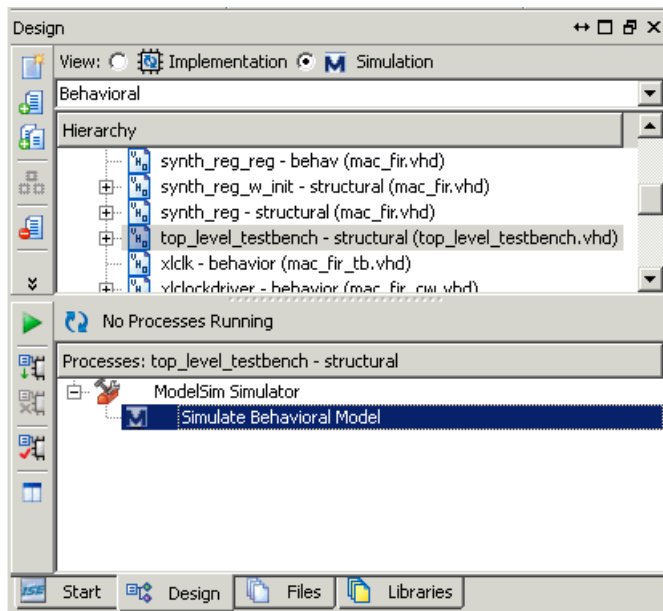

The **Process Properties** dialog box shows that the System Generator .do file is already associated as a custom file for this process.

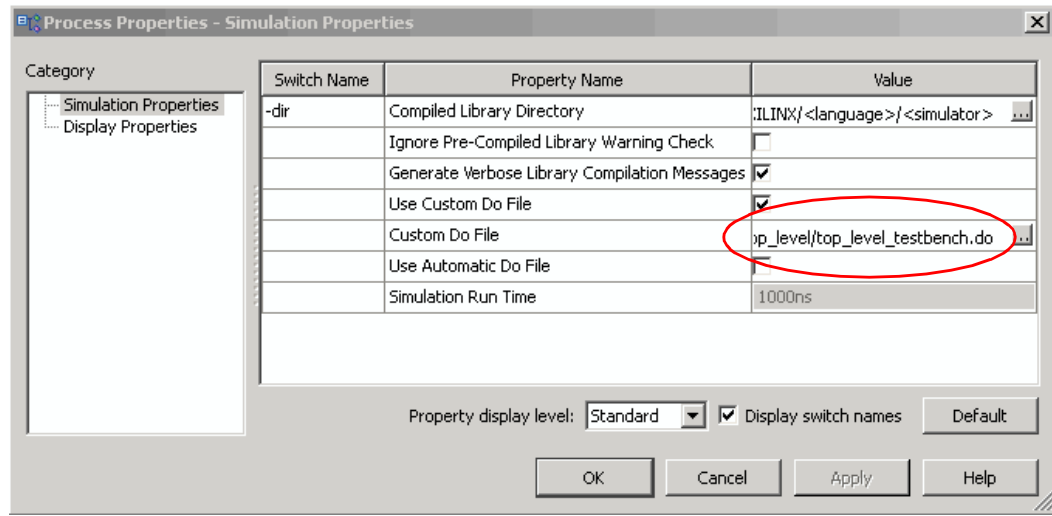

Now if you double-click on the simulation process, the ModelSim console opens, and the associated custom do file is used to compile and run your System Generator testbench. The testbench uses the same input stimuli that was generated in Simulink, and compares the HDL simulation results with the Simulink results. Provided that your design was error free, ModelSim reports that the simulation finished without errors.

## Generating an FPGA Bitstream

### Xilinx ISE Project Navigator

During code generation, the System Generator creates several project files for use in Xilinx and partner software tools. One of these project files is for the Xilinx ISE® Project Navigator tool. By opening this project file, you can import your System Generator design into the Project Navigator, and from there, you can synthesize, simulate, and implement the design. This file is called <design\_name>\_cw.ise and it is created in the target directory specified in the System Generator token.

**Note:** my\_project\_cw.ise is used in the following discussion.

### Opening a System Generator Project

You may double-click on your .ise file in Windows Explorer. The Project Navigator file association with .ise causes Project Navigator to launch, opening your my\_project\_cw.ise System Generator design project. You may also open the Project Navigator tool directly, then choose **File > Open Project** from the top-level pull down menu. Browse to the location of your System Generator my\_project\_cw.ise and open it.

## Customizing your System Generator Project

When first opening your System Generator project, you will see that it has been set up with the synthesis tool, device, package, and speed grade that you specified in the System Generator token. To change these settings, right-click on **top\_level** in the Design Implementation View and select **Design Properties...**

This brings up the **Design Properties** dialog box. From this dialog box, you can change your Device, Package, Speed, and Synthesis Tool. Note that if you change the device family, the Xilinx IP cores that were produced by System Generator must be regenerated. In such a case, it is better if you return to the System Generator and re-generate your project.

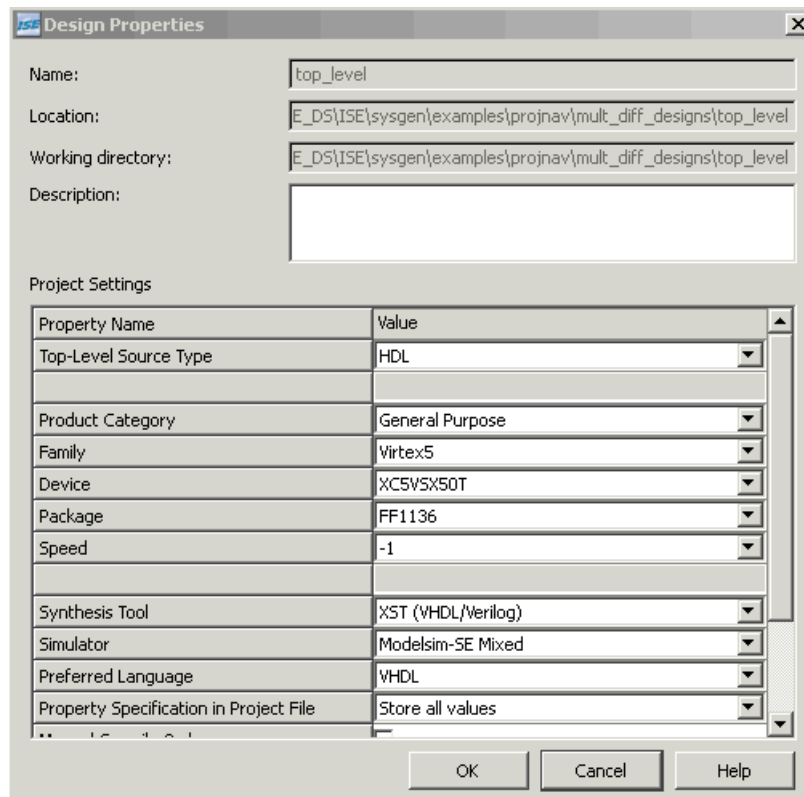

## Implementing Your Design

You have many options within Project Navigator for working on your project. You can open any of the Xilinx software tools such as the Constraints Editor, report viewers, etc. To implement your design, you can simply instruct Project Navigator to run your design all the way from synthesis to bitstream. In the **Sources** window, select the top-level HDL module in your design. In our example the top-level HDL module is named

my\_project\_cw - structural. The **Processes** window shows the processes that can be run on the top-level HDL module.

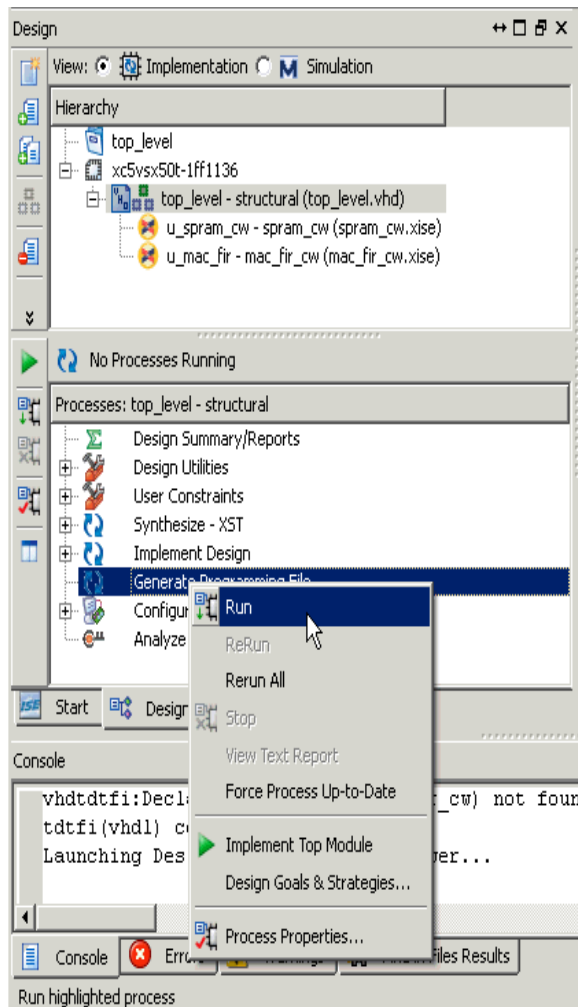

In the **Processes** window, if you right-click on Generate Programming File and select Run, you are instructing Project Navigator to run through whatever processes are necessary to produce a programming file (FPGA bitstream) from the selected HDL source. In the messages console window, you see that Project Navigator is synthesizing, translating, mapping, routing, and generating a bitstream for your design.

Now that you have generated a bitstream for your design, you have access to all the files that were produced on the way to bitstream creation.

## Resetting Auto-Generated Clock Enable Logic

System Generator provides a bit and cycle accurate modeling of FPGA hardware in the Simulink environment. Several clocking options are available including the default option **Clock Enables**. With this option, System Generator uses a single clock accompanied by clock enables (ce) to keep various sample domains in sync. Multirate clocking is described in detail in the topic [Compilation Results](#). System Generator models are often included as part of a bigger system design which need dynamic control for specifying the beginning of data path sampling. To allow this control within a bigger framework System Generator token provides an optional `ce_clr` port in the top-level HDL clock wrapper for resetting the clock enable generation logic. The figure below shows the reset of the CE4 signal generation logic after `ce_clr` signal is de-asserted.

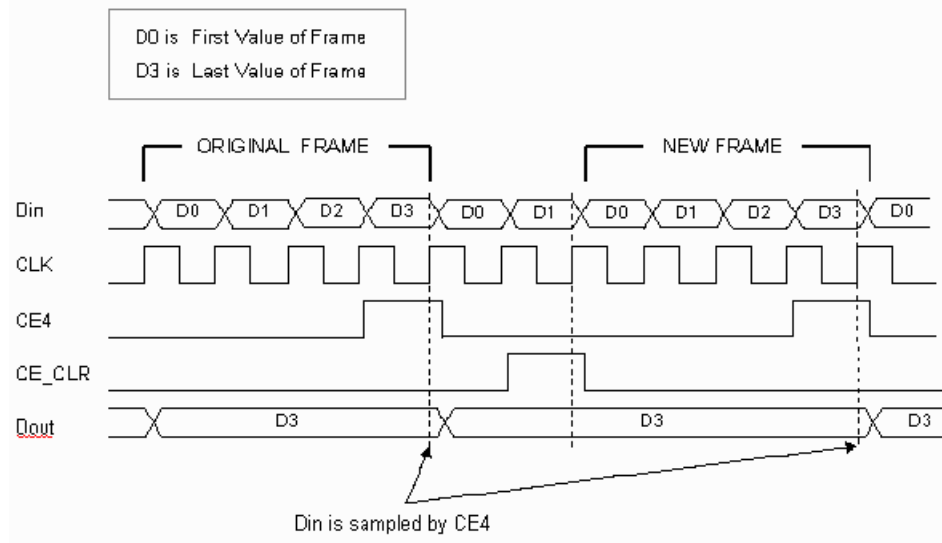

The effect of `ce_clr` signal cannot be simulated using the original System Generator design. To model this behavior within Simulink follow the steps below:

1. Select **Provide clock enable clear pin** and [NGC Netlist Compilation](#) option on the [System Generator](#) token.
2. Press the **Generate** button on the System Generator token.
3. Run the following command from the MATLAB console to produce the post translate VHDL netlist. Use `-ofmt verilog` with netgen for generating Verilog netlist:
 

```
>> !netgen -ofmt vhdl ./<target_directory>/<design_name>_cw.ngc
```
4. Bring in the post translate VHDL/Verilog file as a Black Box within Simulink and use HDL co-simulation to model the effect of asserting `ce_clr` signal on your design.

### ce\_clr and Rate Changing Blocks

The `ce_clr` signal changes the sampling phase of all the multi-sample data signals. This behavior has the potential of changing the functionality of all rate changing blocks which rely heavily on the ce signal to have a periodic occurrence. The various rate changing blocks and their behavior with regards to the de-assertion of the `ce_clr` signal is explained in the table below. These blocks were characterized by importing and simulating the post translate HDL model as a black box.

Table 1-1:

Block Name	Synchronized to ce_clr	Synchronized to ce after ce_clr deasserted ( 1 sample cycle delay)	Behavior after ce_clr is de-asserted and the next ce pulse
Down Sampler with Last Value of frame	Yes	N/A	The last sampled value is held till the new ce signal arrives.
Down Sampler with First Value of frame	No	No	Re-synchronization does not occur after de-assertion of the ce_clr signal.
Up Sampler with copy samples	Yes	N/A	In hardware, this block is implemented as a wire.
Up Sampler with zeros inserted	No	Yes	The last value (zero or sample) is held till the next destination ce signal arrives.
Time Division Multiplexer	No	Yes	The TDM block samples through all the remaining input channels and then sets the output to 0 till the next ce arrives. The new ce signal re-synchronizes the output to the new frame definition.
Time Division Demultiplexer	No	Yes	The TDD block holds the output channels to the same value till the next ce signal arrives. The new ce signal re-synchronizes the output to the new frame definition.
Parallel to Serial	No	Yes	The p2s block samples through all the remaining data words and then holds the output to the last sampled word until the next ce arrives. The new ce signal starts the conversion of the parallel data stream to a serial one.
Serial to Parallel	No	Yes	The s2p block holds the output when the ce_clr is asserted. When de-asserted, the input is sampled on the last value of the input sample frame, and the output occurs on the first ce pulse corresponding to the output rate.

Table 1-1:

Block Name	Synchronized to ce_clr	Synchronized to ce after ce_clr deasserted ( 1 sample cycle delay)	Behavior after ce_clr is de-asserted and the next ce pulse
Addressable Shift Register (ASR)	No	Yes	The ASR block will hold the values in the shift register when ce_clr is asserted. When de-asserted, the stored values will be shifted out, and new data will be put into the shift register.
Polyphase FIR	No	No	Interpolating or Decimating FIR does not work with the ce_clr signal unless the optional reset port is used to reset the FIR after the ce_clr is de-asserted.

### ce\_clr Usage Recommendations

- Based on the above analysis, the ce\_clr signal can be used if the following recommendations are adhered to:
- Replace down sampler blocks with first value of frame behavior with an equivalent circuit using down sampler block with last value of frame selected.
- Design for N clock cycles of invalid data after ce\_clr is de-asserted, where N is the slowest ce associated with the block.
- Design the model to always use down sampler with last value of frame and up sampler with copy samples.
- If N cycle invalid data is not desired replace parallel to serial, serial to parallel, time division multiplexer and time division demultiplexer block with an equivalent circuit built out of a counter, mux and up/down sampler blocks. The equivalent design circuit should also have a reset port pulled to the top-level and connected to the same signal driving the ce\_clr port.
- Counters used in performing operations like multiply-accumulate should always be reset using a combination of user reset which is tied to the ce\_clr signal and ce signal extracted from the [Clock Enable Probe](#) block.
- Always verify the effect of ce\_clr signal on the design by importing and simulating the post translate HDL model as a black box.

## Design Styles for the DSP48

### About the DSP48

Xilinx Virtex® and Spartan® devices offer an efficient building block for DSP applications called the DSP48 (also known as the Xtreme DSP Slice). The DSP48 is available as a System Generator block which is a wrapper for the DSP48 UNISIM primitive. Architectural and usage information for this primitive can be found in the DSP48 Users Guide for your device.

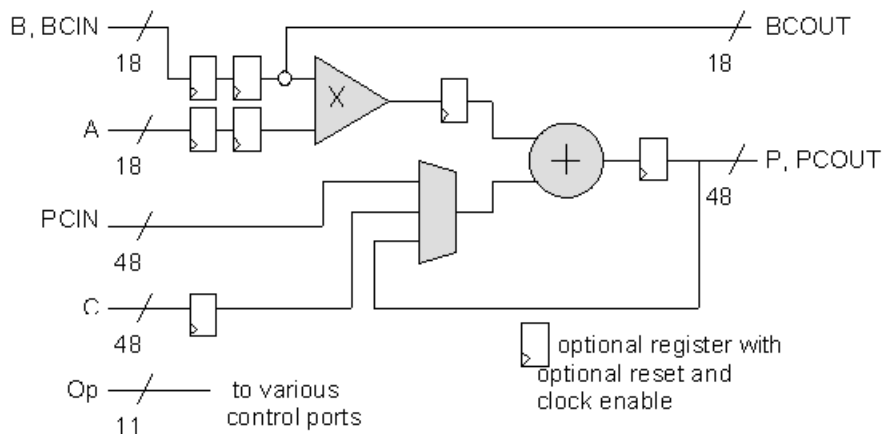

The DSP48 combines an 18-bit by 18-bit signed multiplier with a 48-bit adder and a programmable mux to select the adder's inputs. It implements the basic operation: " $p = a * b + (c + cin)$ "; however other operations can be selected dynamically. Optional input and multiplier pipeline registers are also included and must be used to achieve maximum speed. Also included with the DSP48 are high performance local interconnects between adjacent DSP48 blocks (BCIN-BCOUT and PCIN-PCOUT). The DSP48 also includes support for symmetric rounding. This combination of features enables DSP systems which use the higher-speed DSP48 devices to be clocked at over 500 MHz.

There are three ways to program a DSP48 in System Generator:

- **Use Standard Components** - Map designs to Mult and AddSub blocks or use higher-level IP such as the MACFIR filter generator blocks. This approach is useful if the design uses a lower-speed clock and the mapping to DSP48s is not required.
- **Use Synthesizable Blocks** - Structure the design to map onto the DSP48's internal architecture and compose the design from synthesizable Mult, AddSub, Mux and Delay blocks. This approach relies on logic synthesis to infer DSP48 blocks where appropriate. This approach gives the compiler the most freedom and can often achieve full-rate performance.
- **Use DSP48 Blocks** - Use System Generator's DSP48 and DSP48 Macro blocks to directly implement DSP48-based designs. This is the highest performance design technique. Be aware however that obtaining maximum performance and minimum area for designs using DSP48s may require careful mapping of the target algorithm to the DSP48's internal architecture, as well as the physical planning of the design.



## Designs Using Standard Components

Designs for Xilinx FPGAs such as Spartan®-3 will compile to the Virtex®-4 devices. Multipliers will be mapped into the DSP48 block, however, logic synthesis tools cannot pack adders and muxes into the DSP48 block since these blocks are delivered as cores which prevents synthesis from optimizing the logic. Place and route tools do place the MULT18x18S and MULT18x18 into the DSP48 block but do not pack the adder, or mux into the DSP48 block. (PAR will however pack the mux into the LUT-based adder).

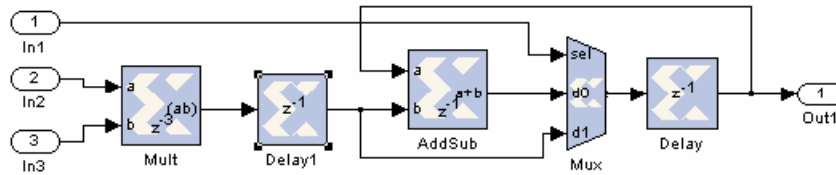

To obtain the best possible performance, you should set the multiplier latency to 3 and include an input register to cover the delay from the DSP48's output to the adder. In Virtex®-4, unlike Spartan®-3 devices, the multiply speed is nearly independent of bit width. For medium speed designs, this approach works fine.

An additional way to use the DSP48 is to use IP blocks optimized for the DSP48 such as the MACFIR block available from coregen, or to use the architecture wizard to generate a custom configured DSP48. Both of these approaches require importing the logic containing the DSP48 as a black box into System Generator. Simulation will require ModelSim HDL cosim.

## Designs Using Synthesizable Mult, Mux and AddSub Blocks

Synthesis tools now have the ability to infer DSP48 logic. This enables the tools to pack adders, multipliers and muxes into the DSP48 block, as well as to enable the application of retiming and other synthesis techniques such as register duplication.

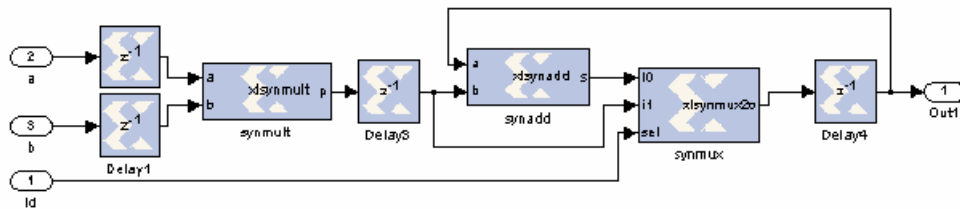

If the design is composed of synthesizable blocks, both Synplify Pro and XST have demonstrated the ability to infer DSP48s and to make use of the DSP48's local interconnect buses (PCOUT-PCIN and BCOUT-BCIN). In the above example, three blocks have been built using the MCode blocks which are defined by the following M-functions.

```
function o = xlsynmux2(i0,i1,sel)
if (sel==0) o=i0; else o=i1; end

function p = xlsynmult(a,b)
p=a*b;

function s = xlsynadd(a,b)
s=a+b;
```

For synthesis to work, the circuit must be mappable to the DSP48 and signal bitwidths must be less than the equivalent buses in the DSP48.

You should keep in mind that the logic synthesis tools are rapidly evolving and that inferring DSP48 configurations is more of an art than a science. This means that some mappable designs may not be mapped efficiently, or that the mapping results may not be consistent. It will be necessary to inspect the post synthesis netlist using a tool similar to Synplify Pro's gate-level technology viewer to determine if the design is being correctly mapped. If not, it may be possible to recast it to be correctly inferred. A model of a fully synthesizable FIR filter is located at the following pathname in the System Generator software tree:

```
.../sysgen/examples/dsp48/synth_fir/synth_fir_tb.mdl
```

## Designs that Use DSP48 and DSP48 Macro Blocks

### DSP48 Block

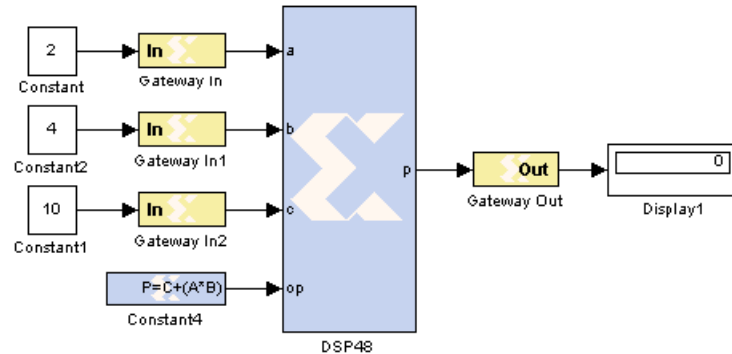

The [DSP48](#) block is effectively a wrapper for the DSP48 UNISIM primitive. Because of this, any possible DSP48 design can be implemented. This low-level implementation however requires an 11-bit binary opcode to be routed to the DSP48's control ports in order to configure its function. The [Constant](#) block has a special mode enabling it to generate a DSP48 control field. The DSP48's parameters dialog box is used to configure the pipelining mode of the DSP48 as well as the use of the DSP48's local interconnect buses named PCOUT-PCIN and BCOUT-BCIN. You can try out the DSP48 block by opening the simmlink model that is located at the following pathname in the System Generator software tree:

```
.../sysgen/examples/dsp48/dsp48_primitive.mdl
```

### Dynamic Control of the DSP48

The DSP48 has the unique capability of being able to change its operation on a per cycle basis. This is useful in applications where the DSP48 is used in a 'resource shared' mode such as a FIR filter where multiple taps are implemented by the same multiplier. A simple

method of generating this type of control pattern is to use a mux to select the DSP48 instruction on a clock by clock basis.

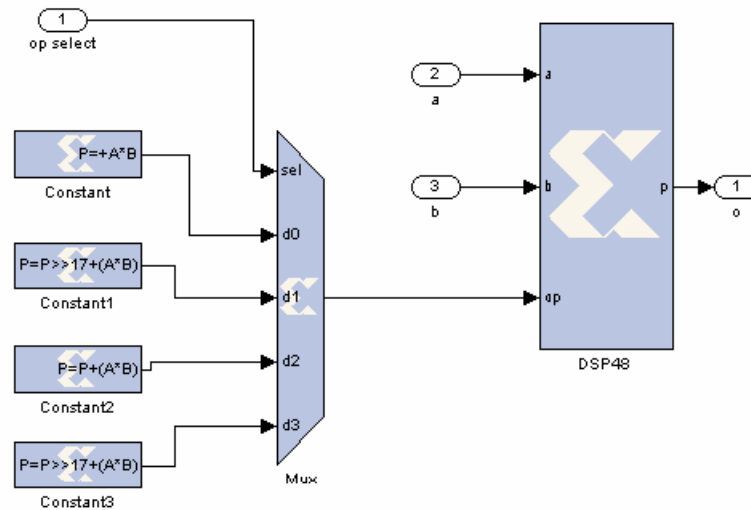

The above example illustrates the use of a DSP48 and Constant blocks to implement a 35-bit by 35-bit multiplier over 4 clock cycles. During synthesis, the mux and constant logic is reduced by logic optimization. In the example above, the DSP48 block and the 4:1 mux are reduced to just two 4-LUTs. A Simulink model that illustrates how to implement both parallel and sequential 35\*35-bit multipliers using dynamic operation for the sequential mode of operation is located at the following pathname in the System Generator software tree:

.../sysgen/examples/dsp48/mult35x35/mult35x35\_tb.mdl

### DSP48 Macro Block

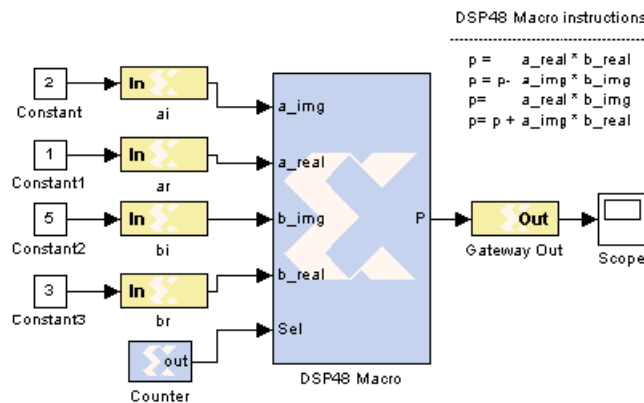

The [DSP48 Macro](#) block is a wrapper for the DSP48 block which makes it simple to implement a sequence of DSP48 instructions (known as dynamic instructions). In addition, it provides support for specifying input and output types. For example, in the model above, a DSP48 Macro block is configured to implement a complex multiplier using a sequence of four different instructions. The instructions are entered in a text window in the DSP48 Macro's dialog menu. You can try out the DSP48 Macro block by opening the simulink model that is located at the following pathname in the System Generator software

```
tree:
.../sysgen/examples/dsp48/dsp48_macro.mdl
```

## Replacing a DSP48 Macro Block with DSP48 Macro 2.0 Block

In Release 11.4, Xilinx introduced version 2.0 of the DSP Macro block. The following text describes how to replace an existing DSP Macro block with a DSP Macro 2.0 block.

One fundamental difference of the new DSP48 Macro 2.0 block compared to the previous version is that internal input multiplexer circuits are removed from the core in order to streamline and minimize the size of logic for this IP. This has some implications when migrating from an existing design with DSP48 Macro to the new DSP48 Macro 2.0. You can no longer specify multiple input operands (i.e. A1, A2, B1, B2, etc...). Because of this, you must add a simple MUX circuit when designing with the new DSP48 Macro 2.0 if there is more than one unique input operand as shown in the following example.

### DSP48 Macro-Based Signed 35x35 Multiplier

The following DSP48 Macro consists of multiple 18-bit input operands such as alo, ahi for input to port A and blo, bhi for input to port B. The input operands and Opcode instructions are specified as shown below. Notice that the multiple input operands are handled internally by the DSP48 Macro block.

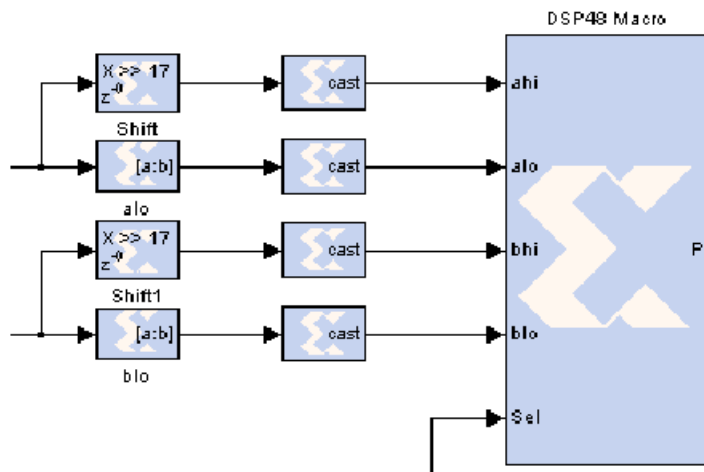

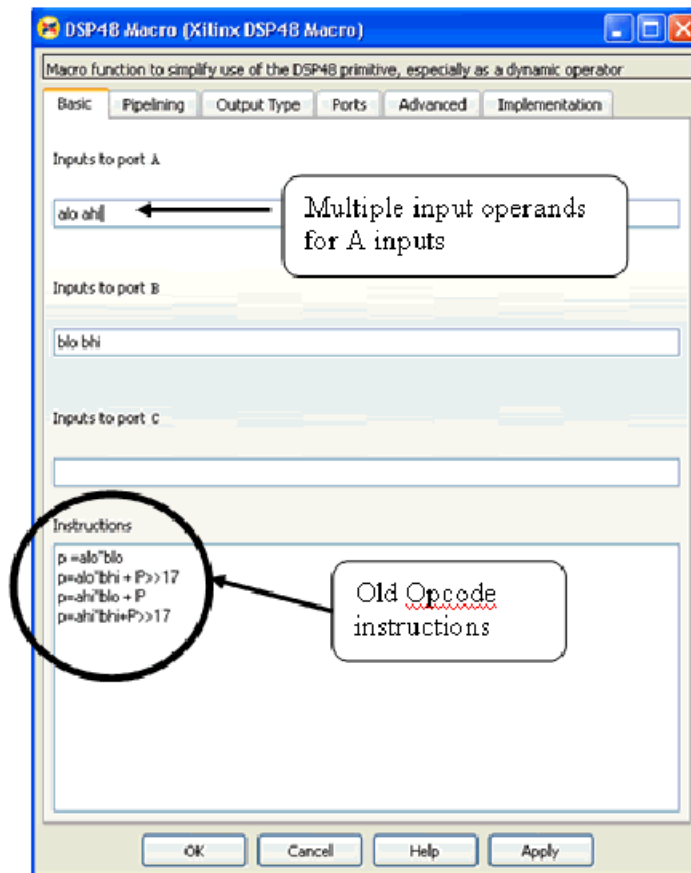

### DSP48 Macro 2.0-Based Signed 35x35 Multiplier

The same model shown above can be migrated to the new DSP48 Macro 2.0 block. The following simple steps and design guidelines are required when updating the design.

1. Make sure that input and output pipeline register selections between the old and the new block are the same. You can do this by examining and comparing the Pipeline Options settings.
2. If there is more than one unique input operand required, you must provide MUX circuits as shown in the figure below.
3. Ensure that the new design provides the same functionality correctness and quality of results compared to the old version. This can be accomplished by performing a quick Simulink simulation and implementing the design.
4. When configuring and specifying a pre-adder mode using the DSP48 Macro 2.0 block in System Generator, certain design parameters such as data width input operands are device dependent. Refer to the LogiCORE IP DSP48 Macro v2.0 Product Specification for details on all the parameters on this LogicCore IP.

4 inputs and 2 outputs MUX circuit can be decoded as the following:

sel	A inputs	B inputs	Opcode
0	alo	blo	A*B
1	alo	bhi	A*B+P>>17
2	ahi	blo	A*B+P
3	ahi	bhi	A*B+P>>17

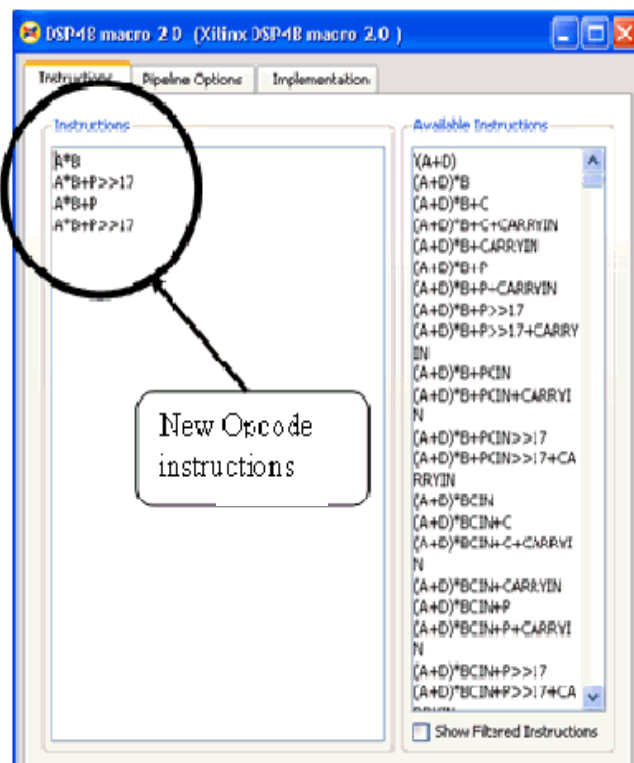
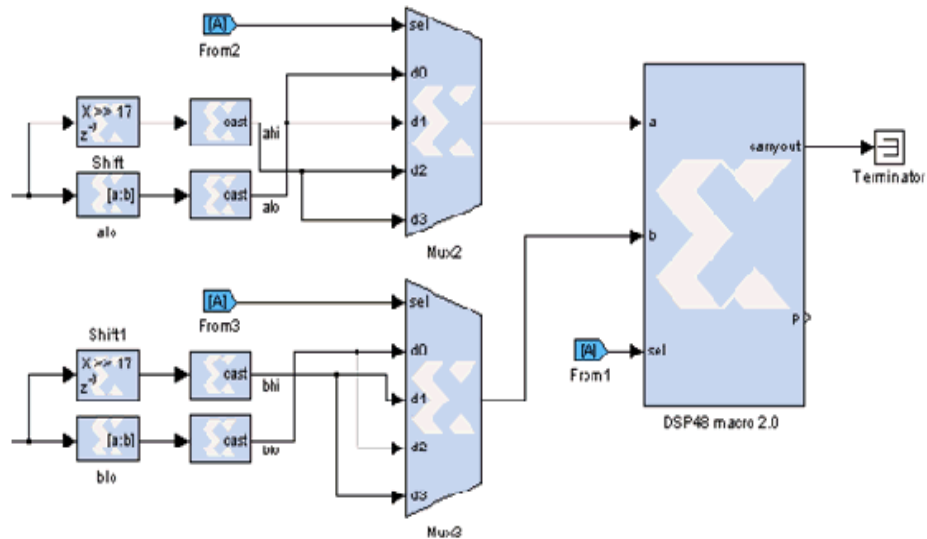

You can find the above complete model at the following pathname:  
 <sysgen\_path>/examples/dsp48/mult35x35/dsp48macro\_mult35x35.mdl

## DSP48 Design Techniques

### Designing Filters with the DSP48

The DSP48 is an ideal block to implement FIR filters. You can examine how to use the DSP48 block for Type 1 and Type 2 FIR filters by opening the simulink model that is located at the following pathname in the System Generator software tree:  
 .../sysgen/examples/dsp48/firs/dsp48\_firs\_tb.mdl

### Design Techniques for Very-High Performance Designs

DSP48-based designs usually require I/O, BRAMS and SLICE logic. Typically, this associated SLICE logic is used to implement delay registers, SRL16s, muxes, counters, and control logic. Since the DSP48 block is expected to operate at speeds greater than 500 MHz, other components will also be required to operate at the same speed. This generally requires special design techniques for the non-DSP48 logic.

At 500 MHz only 2 ns is available in each clock. For V4-11 devices, roughly 300 ps are required for register clock to out and 300 ps for setup. For comparison, a LUT delay is 166 ps. Special inputs and outputs such as clock enables and DSP48 and BRAM signals generally have setup and clock to out times closer to 500 ps. With clock skew and jitter, roughly 1 ns is available for net delays. This restriction will generally allow only 1 net in each path and it must be fairly short.

There are a number of guidelines that can be used to insure the operation at DSP48 speeds. Some of these guidelines are outlined below.

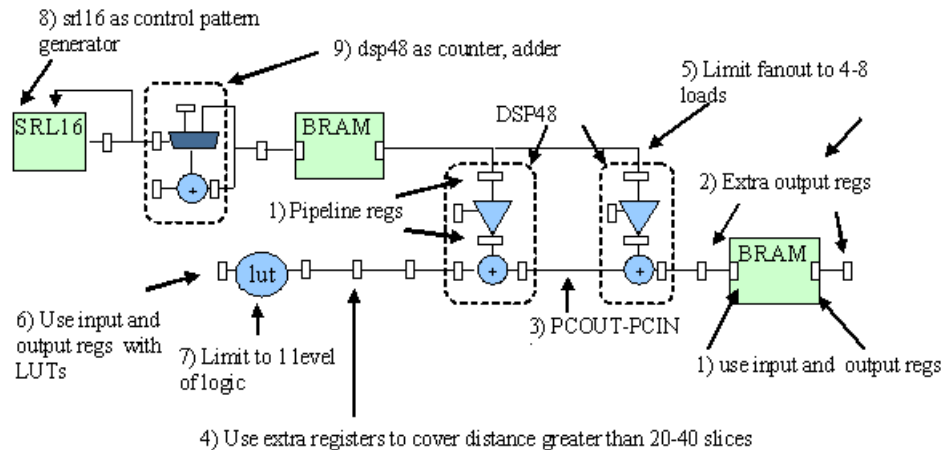

1. Always use DSP48, BRAM16, FIFO16 with input, mult and output registers
2. Use additional FF to buffer DSP48 and BRAM outputs if necessary
3. Plan out the usage of the PCOUT-PCIN bus to allow DSP48 chaining
4. Add registers to any path that is greater than 20 - 40 slices long
5. Limit fanout to 32 loads located within a 20 slice distance
6. Add output registers to any LUT-based logic
7. Limit LUTs to 1 level or a 4:1 MUX and insure a local register for input or output

8. Use RAMs, SRL16 to clock out control patterns instead of state machines
9. Use DSP48 to implement counters and adders greater than 8-16 bits
10. Use area constraints – "INST ff1\* LOC = SLICE\_X0Y8:SLICE\_X1Y23;"

## Physical Planning for DSP48-Based Designs

The DSP48 requires correct placement to achieve dense, high performance designs. While the automatic place and route tools do a good job, the best results may require manual placement of DSP48 and RAM blocks. There are several additional issues with the DSP48s.

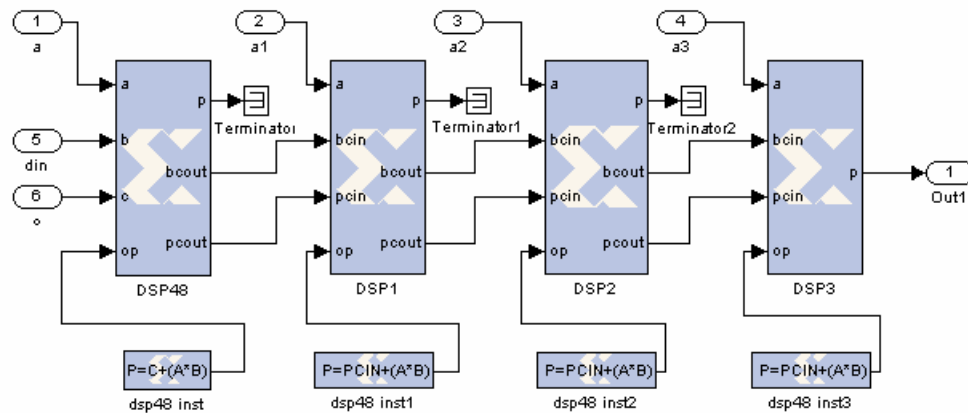

### Cascade Routing Buses

Adjacent DSP48 blocks are connected with two local buses called PCOUT, and BCOUT. The PCOUT bus is used to pass accumulation data from one DSP48 to the next. The BCOUT bus is used to pass delayed B input data to the next DSP48. The DSP48 and DSP48 Macro block both support PCOUT and BCOUT buses. The use of the buses is shown in the figure above, which illustrates a pipelined 4-Tap Type 1 FIR filter.

### C-Input Sharing

Each pair of DSP48s share a single C input. You should be aware of this when you do resource planning. Since the placer will not always find the most optimal placement to share C inputs, DSP48s should avoid using C inputs if possible.

### Adder Trees Planning

Tree-based filter topologies are problematic for efficient DSP48 implementation. An adder tree requires isolated 2-input adders. Two input 36-bit adders can be implemented using a single DSP48, however this requires a C input and precludes the use of the multiplier. In addition, the long signals between DSP48s may require additional pipeline stages. A better approach is to convert the tree into a pipelined cascade.

### Placement

Most designs will benefit from some placement of DSP48 and BRAMs. Use of area constraints to constrain LUT fabric logic placement may also be beneficial.

### Signal Length Planning

At 500 MHz, signal lengths should be limited to around 20 slices. This means that long signals should have multiple pipeline stages.



## Clock Enable Planning

When using the **Clock Enables** clocking option, the clock enables are often the limiting path at high frequencies. This is partially due to System Generator's use of LUTs to gate clocks at the destination. To avoid clock enables in the critical path, avoid using the System Generator upsampled and downsampled clock domains. This requires the manual use of clock enables for logic that runs at less than the system clock rate.

## Place and Route Flow

- Use the command `map -timing` with effort level high for both map and place
- Use `trce -v 100` to get a good sense of the failing nets and inspect the `xflow/design.twr` file to understand the nature of the design's timing.
- The file `bitstream_v4.opt` is available in the `examples/dsp48` directory. This file can be used with the **Bitstream** compile target to set the PAR options mentioned above.

## Synthesis Flow

- Use Synplify Pro with retiming and pipelining enabled to avoid having to manually pipeline every LUT and signal.
- Use Synplify Pro with the fanout limit set around 32 to avoid long net delays.
- Open compiled projects in Synplify Pro and inspect the generated logic using the RTL- and Gate-level views to get a good idea of what logic is being generated.
- The file `syn.pl` is available in the `examples/dsp48` directory. Place this file in `<ISE_Design_Suite_tree>/sysgen/scripts` directory to modify the synthesis options in System Generator

## Logic Depth Planning

The following rules seem to allow the LUT fabric to run at 450 MHz using a -11 V4 device:

- Only one net can be allowed in a critical path at 450 MHz. This allows a 4:1 mux to a reg a 4\_input LUT to a reg or a net through a LUT directly to a DSP48
- Counters up to 16-bits can be used, but do not use count limited counters without additional pipelining
- If accumulators or counters are used, invert the enable line to an active-low condition to prevent a extra LUT from being inserted in the critical path
- Any adders must have local input registers. It may be necessary to place control counters in the DSP48 to insure speed.

## Fanout Planning

Avoid fanouts of more than 32 LUTs or 8 DSP48s or BRAMs. This can be avoided by inserting additional pipeline registers in these signals paths.

## Register Retiming

Check retiming on delay blocks to allow them to be used as registers for pipelining. Then use Synplify Pro or XST with retiming enabled to allow the synthesis tool to move registers into optimal positions.

## Using FDATool in Digital Filter Applications

The following example demonstrates one way of specifying, implementing, and simulating a FIR filter using the FDATool block. The FDATool block is used to define the filter order and coefficients and the Xilinx Blocksets are used to implement a MAC-based FIR filter using a single MAC (Multiply-ACcumulate) engine. The quality of frequency response is then validated by comparing it to a double-precision Simulink filter model.

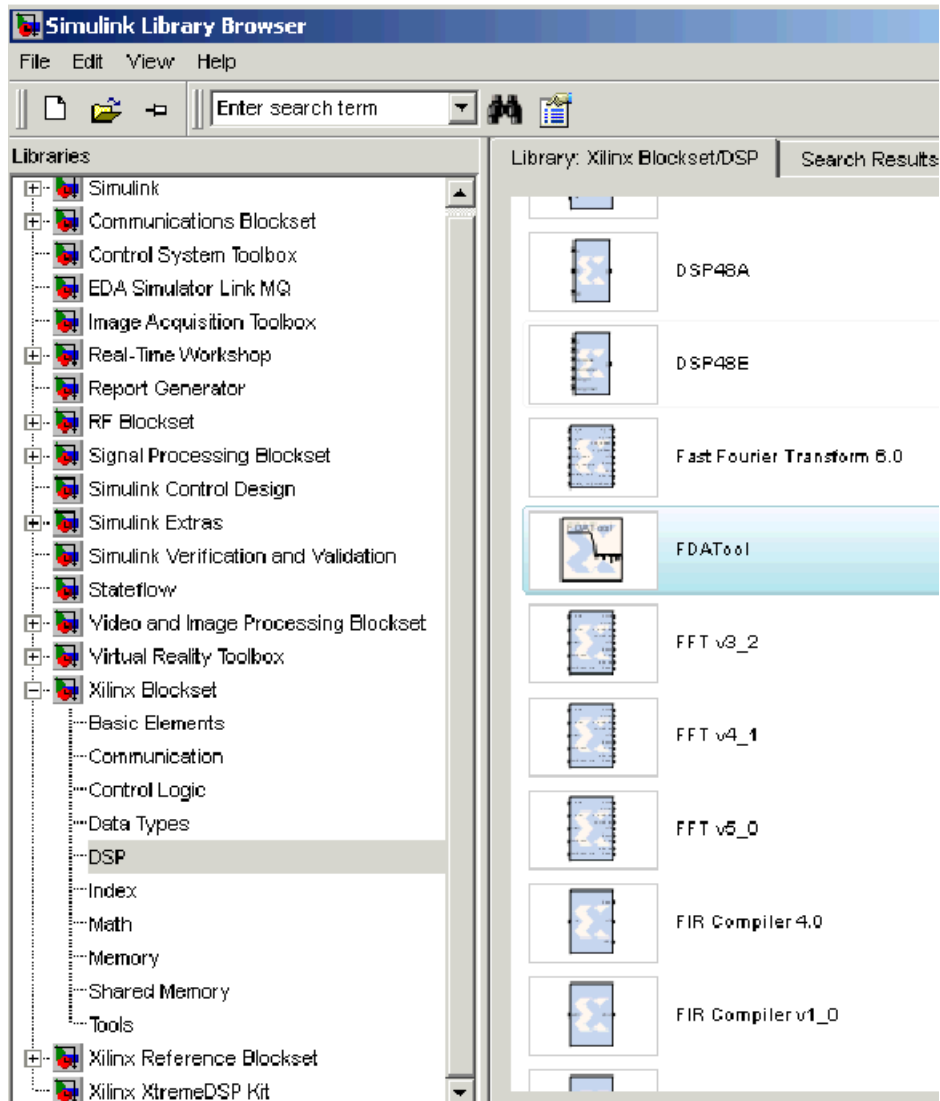

Although a single MAC engine FIR filter is used for this example, we strongly recommend that you look at the DSP Reference Library provided as a part of the Xilinx Reference Blockset. The DSP Reference Library consists of multi-MAC, as well as, multi-channel implementation examples with variations on the type of memory used.

A demo included in the System Generator demos library also shows an efficient way to implement a MAC-based interpolation filter. To see the demo, type the following in the MATLAB command window:

```
>> demo blockset xilinx
```

then select FIR filtering: Polyphase 1:8 filter using SRL16Es from the list of demo designs.

## Design Overview

This design uses the random number source block from the DSP Blockset library to drive two different implementations of a FIR filter:

- The first filter is the one that could be implemented in a Xilinx device. It is a fixed-point FIR filter implemented with a dual-port Block memory and a single multiply-accumulator.
- The second filter is what is referred to as reference filter. It is a double-precision, direct-form II transpose filter.

The frequency response of each filter is then plotted in a transfer function scope.

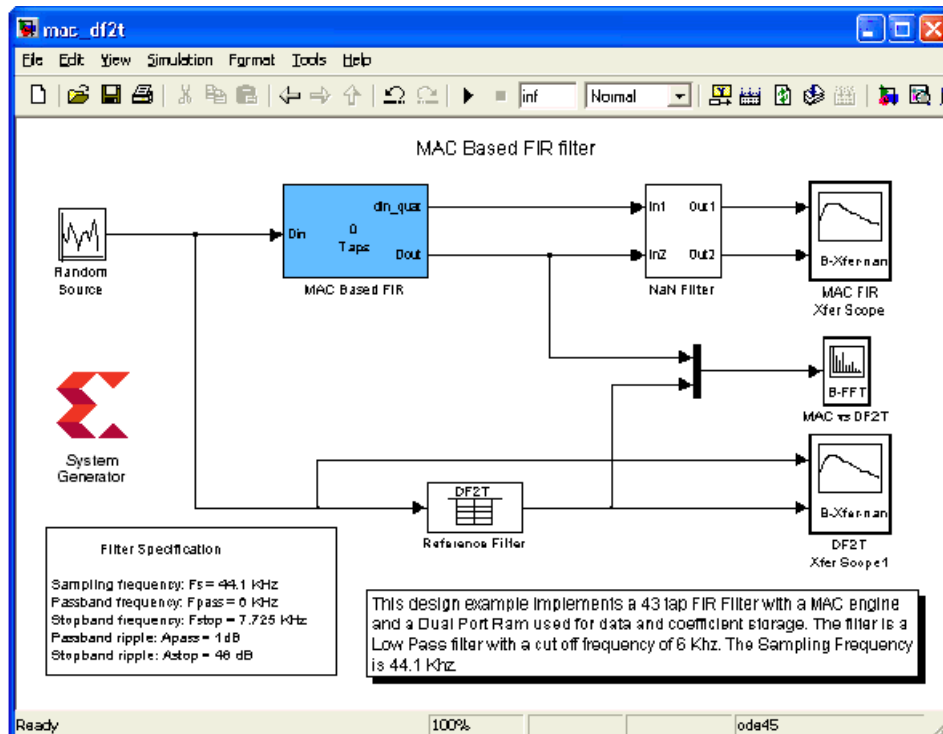

## Open and Generate the Coefficients for this FIR Filter

1. From the MATLAB console window, `cd` into the directory `<ISE_Design_Suite_tree>/sysgen/sysgen/examples/mac_fir`.
2. Open the design model by typing `mac_df2t` from your MATLAB command window.

For the purpose of this tutorial, the variables `coef`, `coef_width`, `coef_binpt`, `data_width`, `data_binpt` and `Fs` are not defined. You will first use these variables as mask parameters to the MAC Based FIR block and then design and assign the filter

coefficients using the FDATool. The fully functional model is available in the current directory and is called `mac_df2t_soln.mdl`.

## Parameterize the MAC-Based FIR Block

1. Right Click on the MAC-Based FIR block and select **Edit Mask** as shown in the figure below.

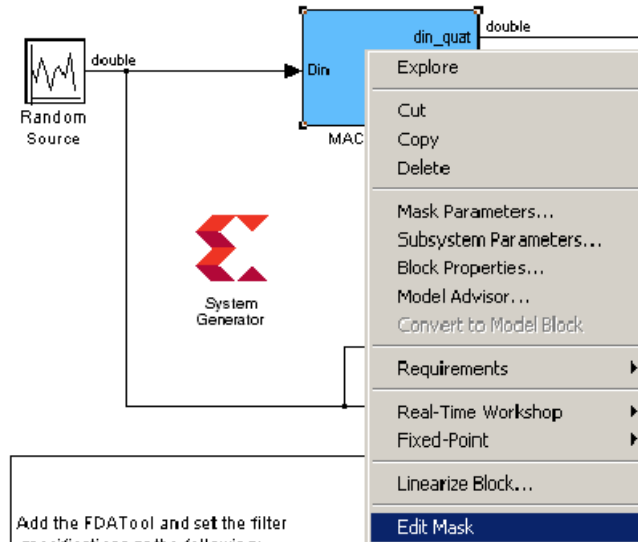

2. Double-click on the Parameters tab and add the parameters `coef`, `data_width` and `data_binpt` as shown below.

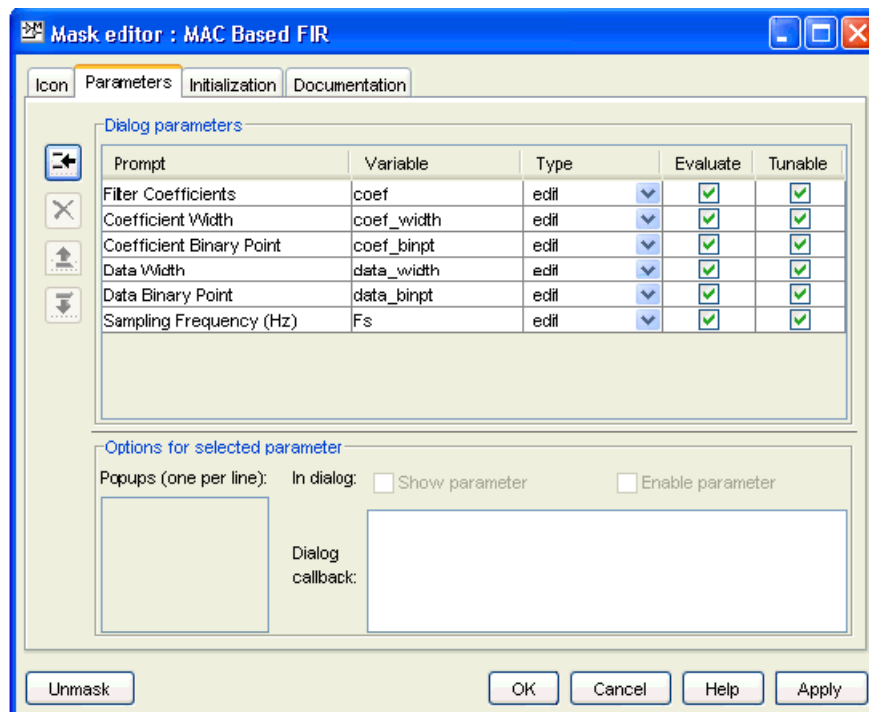

## Generate and Assign Coefficients for the FIR Filter

1. Drag and drop the FDATool block into your model from the DSP Xilinx Blockset Library.
2. Double-click on the FDATool block and enter the following specifications in the Filter Design & Analysis Tool for a low-pass filter designed to eliminate high-frequency noise in audio systems:
  - ◆ Response Type: **Lowpass**
  - ◆ Filter Order: **Minimum order**
  - ◆ Frequency Specifications
    - Units: **Hz**
    - Fs: **44100**
    - Fpass: **6000**
    - Fstop: **7725**
  - ◆ Magnitude Specifications
    - Units: **dB**
    - Apass: **1**
    - Astop: **48**

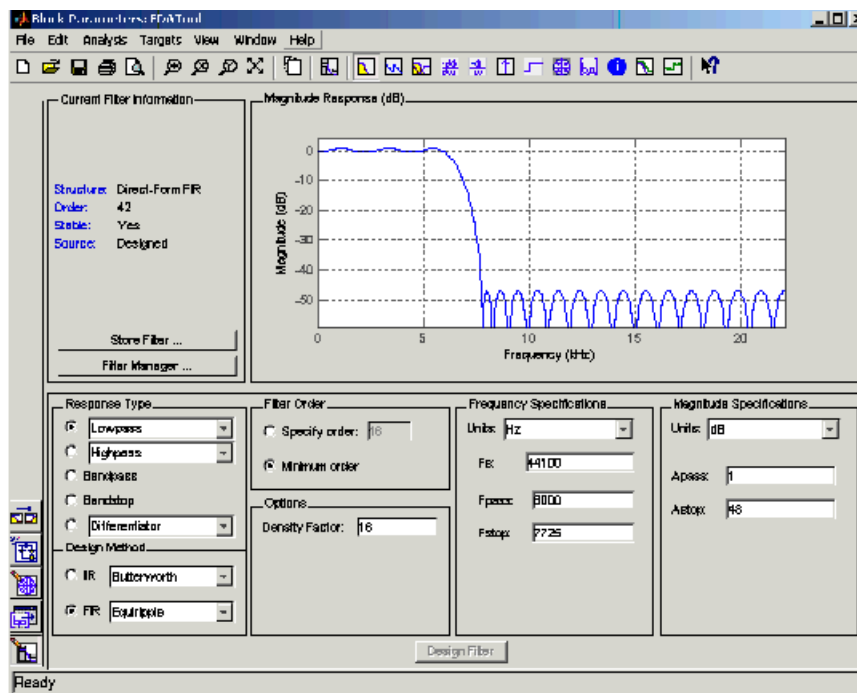

3. Click on **Design Filter** at the bottom of the tool window to find out the filter order and observe the magnitude response.

You can also view the phase response, impulse response, coefficients and more by selecting the appropriate icon at the top-right of the GUI. Based on the FDATool, a 43-tap FIR filter (order 0-42) is required in order to meet the design specifications listed above.

The filter coefficients can be displayed in the MATLAB workspace by typing:

```
>> xlfda_numerator('FDATool')
```

These useful functions help you find the maximum and minimum coefficient value in order to adequately specify the coefficient width and binary point:

```
>> max(xlfda_numerator('FDATool'))
>> min(xlfda_numerator('FDATool'))
```

For this tutorial, the coefficient type has been set to be Fix\_12\_12, which is a 12-bit number with the binary point to the left of the twelfth bit. The result of the max() function above shows that the largest coefficient is 0.3022, which means that the binary point may be positioned to the left of the most significant bit. How do you reason that? A Fix\_12\_12 number has a range of -0.5 to 0.4998, meaning the dynamic range is maximized by putting the binary point left of the most significant bit. If you moved the binary point to the right (by using a Fix\_12\_11 number) you would lose one bit of dynamic range because a Fix\_12\_11 number has a range of -1 to 0.9995, which is more than you require to represent the coefficients.

4. Click on the Reference Filter block and the MAC Based FIR block and verify the parameter values for coef, coef\_width, coef\_binpt, data\_width, data\_binpt and Fs as shown below.

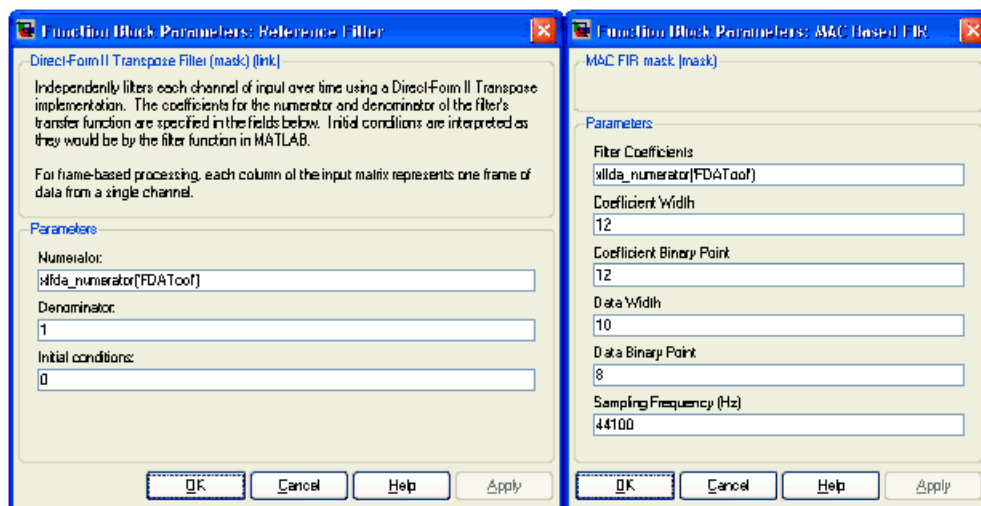

Click OK on each dialog box

## Browse Through and Understand the Xilinx Filter Block

The following block diagram showing how the MAC-based FIR filter has been implemented for this tutorial.

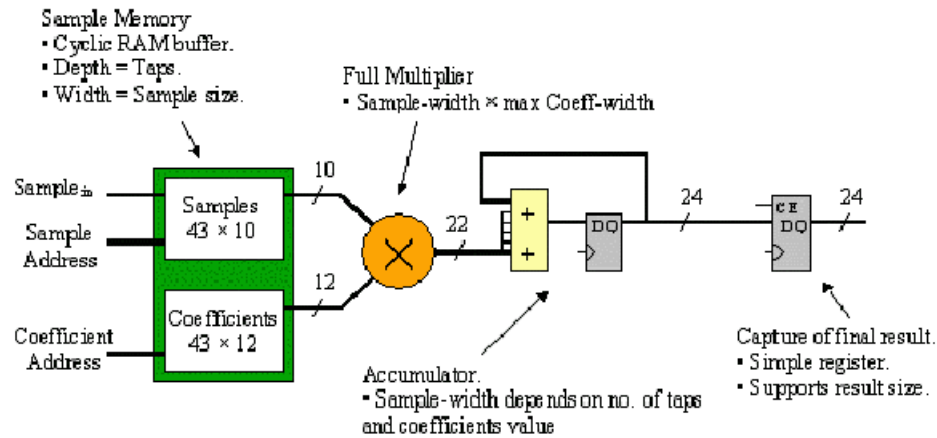

At this point, the MAC filter is set up for a 10-bit signed input data (Fix\_10\_8), a 12-bit signed coefficient (Fix\_12\_12), and 43 taps. All these parameters can be modified directly from the MAC block GUI. The coefficients and data need to be stored in a memory system. For the tutorial, you choose to use a dual-port memory to store the data and coefficients, with the data being captured and read out using a circular RAM buffer. The RAM is used in a mixed-mode configuration: values are written and read from port A (RAM mode), and the coefficients are only read from port B (ROM mode).

The multiplier is set up to use the embedded multiplier resource available in Xilinx Virtex® devices as well as three levels of latency in order to achieve the fastest performance possible. The precision required for the multiplier and the accumulator is a function of the filter taps (coefficients) and the number of taps. Since these are fixed at design time, it is possible to tailor the hardware resources to the filter specification. The accumulator need only have sufficient precision to accumulate maximal input against the filter taps, which is calculated as follows:

$$\text{acc\_nbits} = \text{ceil}(\log_2(\text{sum}(\text{abs}(\text{coef} * 2^{\text{coef\_width\_bp}})))) + \text{data\_width} + 1;$$

Upon reset, the accumulator re-initializes to its current input value rather than zero, which allows the MAC engine to stream data without stalling. A capture register is required for streaming operation since the MAC engine reloads its accumulator with an incoming sample after computing the last partial product for an output sample.

Finally, a downsampler reduces the capture register sample period to the output sample period. The block is configured with latency to obtain the most efficient hardware implementation. The downsampling rate is equal to the coefficient array length.

## Run the Simulation

1. Change the simulation time to 0.05, then run the simulation  
You should get the message shown in the figure below.

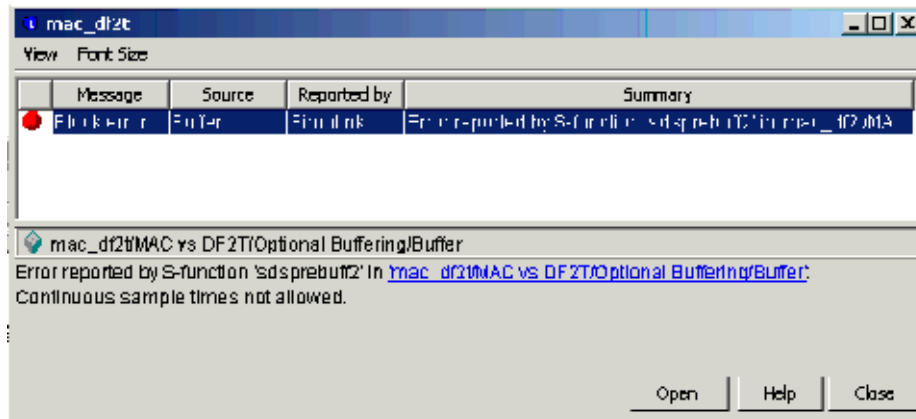

System Generator gets its input sample period from the **din Gateway In** block which has  $1/F_s$  specified as the data input sample period. As the MAC-based FIR filter is over-sampled according to the number of taps, the System Clock Period will always be equal to  $1/(\text{Filter Taps} * F_s)$ .

2. Double click on the System Generator token and change the Simulink system period to specify the System Clock Period as  $5.273427e-007 = 1/(43 * 44100)$  as shown below.

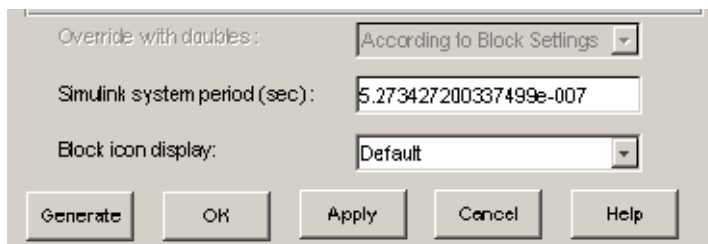

3. Run the simulation again and notice that the Xilinx implementation of the MAC-based FIR filter meets the original filter specifications and that its frequency response is almost identical to the double precision Simulink models.

As you can see, the filter passband response measurement as well as zeros can clearly be seen. You should get similar frequency responses as shown in the following figure.



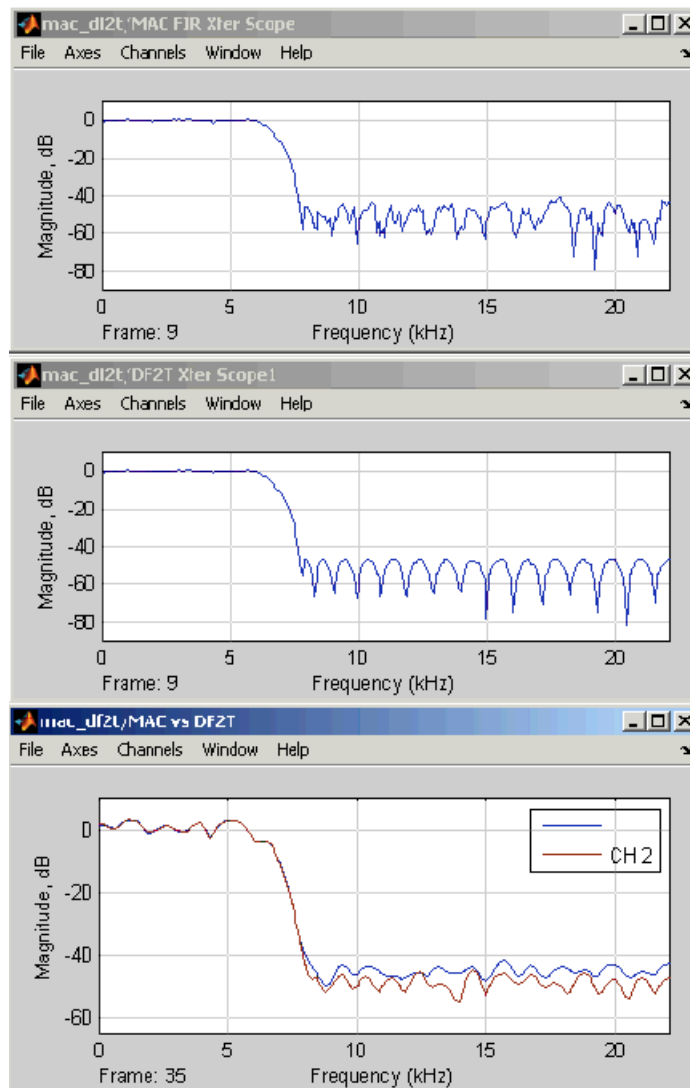

It is possible to increase or decrease the precision of the Xilinx Filter in order to reach the perfect area/performance/quality trade off required by your design specifications.

Stop the simulation and modify the coefficient width to **FIX\_10\_10** and the data width to **FIX\_8\_6** from the block GUI. Update the model (Ctrl-d) and push into the MAC engine block. You should now notice that the datapath has been automatically updated to only eighteen bits on the output of the multiplier and twenty on the output of the accumulator.

Restart the simulation and observe how the frequency response has been affected. The attenuation has indeed degraded (less than 40dB) due to the fixed-wordlength effects.

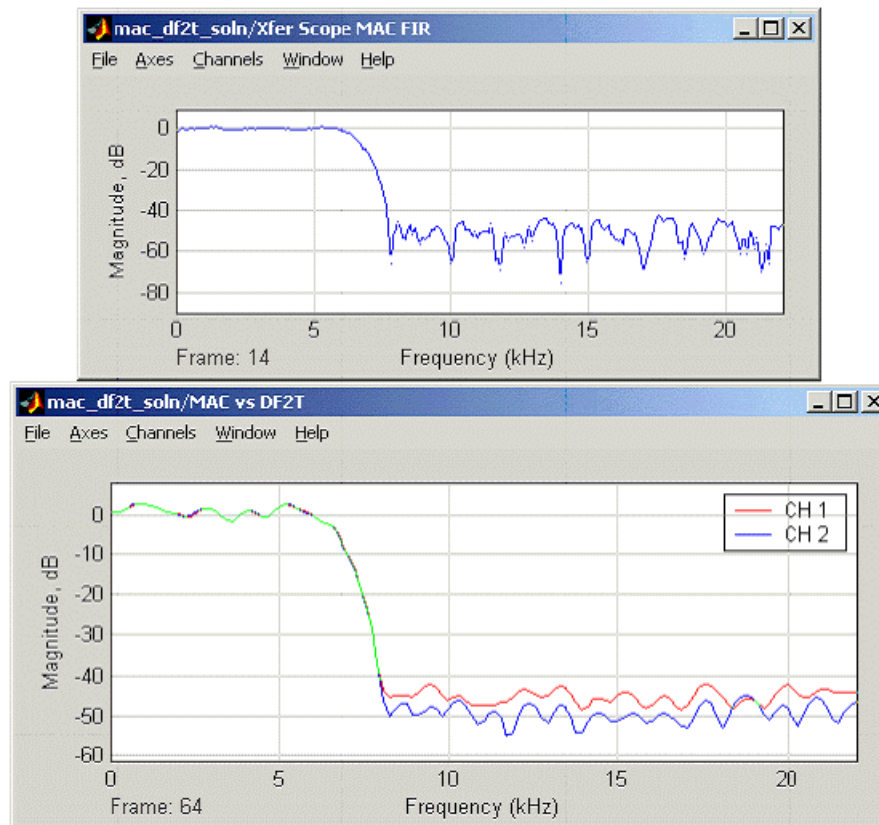

## Generating Multiple Cycle-True Islands for Distinct Clocks

System Generator's shared memory interfaces allow you to implement designs that are driven by multiple-clock sources. These multi-clock designs may employ a combination of distinct clocks and derived clock enables to implement advanced clocking strategies completely within a single design environment. This topic describes how to implement multi-clock designs in System Generator through discussions of the following topics:

- Applications that benefit from multiple clocks;
- Using hierarchy to partition a System Generator model into two or more clock domains;
- Using shared memories to cross clock domains;
- Simulating and netlisting multiple clock designs;
- Wiring multiple clock domains together using the Xilinx [Multiple Subsystem Generator](#) block.

A step-by-step example is provided to help clarify the topics listed above. Although the example uses two clocks, the concepts presented here can be extended so that System Generator designs requiring any number of clock sources can be constructed using similar techniques.

Before continuing with the example, you may want to familiarize yourself with standard System Generator clocking terminology and implementation methodologies. This information is covered in-depth in the topic [Timing and Clocking](#). In general, System Generator designs are driven by a single, system clock source. Multirate design portions are handled using clock enables derived from the system clock source. It is possible, however, to use System Generator to implement designs that are driven by distinct clock sources.

Broadly speaking, the approach is the following:

Divide the design into several subsystems, each of which is to be driven by a different clock. In the example, you call these subsystems *asynchronous clock islands*. Xilinx shared memory blocks should be used as bridges that communicate between these clock islands. Once the design is partitioned, the Xilinx Multiple Subsystem Generator block may be used to translate the design into hardware that uses multiple distinct clock sources.

### Multiple Clock Applications

A common application for multiple clock domains is for interfacing different pieces of external hardware that operate at different clock rates. For example, you may need to provide a set of I/O registers to a microprocessor, and the processor must be able to read and write these registers synchronous to its own clock. You may get data from a clock/data recovery unit and need to re-synchronize the data to your local clock domain. You may need to feed data to a digital-to-analog converter that must be running at a precise sample rate which is different from your system clock.

Another important application for multiple clock domains is in employing a high-speed processing unit. Let us take an example of an interpolating FIR filter. The filter gets symbol data from an external unit, and the filter needs to take the symbols and perform a 4X interpolation that creates four output samples for each input symbol. The output samples are fed to a digital-to-analog converter (DAC) that is clocked at the sample rate.

The FIR filter may be clocked at any of several rates. It may be clocked at the symbol rate, and on each cycle it must create four samples which will then be fed to the DAC at the sample rate. This highly parallel implementation has large hardware resource

requirements and would only be employed if the sample rate were very fast. An alternative approach is to clock the FIR filter at the sample rate, creating one sample per cycle. This scenario takes an intermediate amount of hardware and would be used for intermediate sample rates. If the sample rate is slow, the FIR filter may be clocked at a rate several times faster than the sample rate, perhaps by means of a DCM that multiplies the sample-rate clock. In this way the multiplier-accumulator units of the FIR filter may be reused several times during the calculation of each sample output, requiring the least amount of hardware. This last method would use a symbol-rate clock domain, a high-speed processing clock domain, and a sample-rate clock domain.

A good FPGA design practice is to have each resource in the FPGA device operating at the highest possible rate to optimize hardware usage. In general, it is best to use a single clock domain when possible and to use clock enables to gate slower circuitry, creating multiclock paths. The drawback to this technique is that it increases power consumption and may make it difficult to route the high-speed clock enable. As a result, separate domains for high-speed processing are preferable in some instances. Also, it may not be possible to avoid dealing with different clock domains when dealing with asynchronous data inputs and outputs.

## Clock Domain Partitioning

Partitioning a multiple-clock design into multiple domains is an important aspect of FPGA design. System Generator uses design hierarchy to support clock domain partitioning. More specifically, when a design uses multiple clock domains, the logic associated with each distinct clock domain should be grouped together in a Simulink subsystem.

The subsystems, or in this case, synchronous islands, are cycle-true in the sense that the hardware that is generated for an island is faithful to the Simulink behavior of the island model. The notion of bit and cycle accuracy is preserved only within the individual synchronous islands. The end model containing the synchronous islands is not necessarily cycle-true, because it drives the islands with asynchronous clocks. Although System Generator and Simulink are able to simulate the design using ideal clock sources, the complexities involved with asynchronous clocking systems can result in discrepancies between the software simulations and hardware realizations.

The advantages to partitioning a design using subsystems are manifold:

- The physical clock lines are abstracted away from the block diagram;
- Cross-domain transfers are well-defined and can be handled with metastable-safe blocks from the Xilinx Blockset;
- Because the domains are well-defined, System Generator can accurately produce timing constraints for the synchronous islands.

The abstraction level of System Generator reduces the risk that users will perpetrate some of the more common design errors. These include:

- **Gated Clocks:** because the clocks in System Generator are inferred during hardware generation, it is not possible to connect non-clock lines to clock inputs (i.e., gated clocks).
- **Asynchronous Clears:** because the asynchronous resets in System Generator are inferred during hardware generation, it is not possible to explicitly clear synchronous logic using the asynchronous reset, which often results in timing problems.
- **Inferred Latches:** latches will not be generated from System Generator designs.

## Crossing Clock Domains

System Generator shared memory blocks should be used whenever it is necessary to cross clock domains. The tool provides several blocks for transferring data across clock domains, each of which is available in the Xilinx Shared Memory library:

- [Shared Memory](#)
- [To FIFO](#) / [From FIFO](#)
- [To Register](#) / [From Register](#)

When these shared memory blocks are used to cross clock domains, each set should be split into a matched pair.

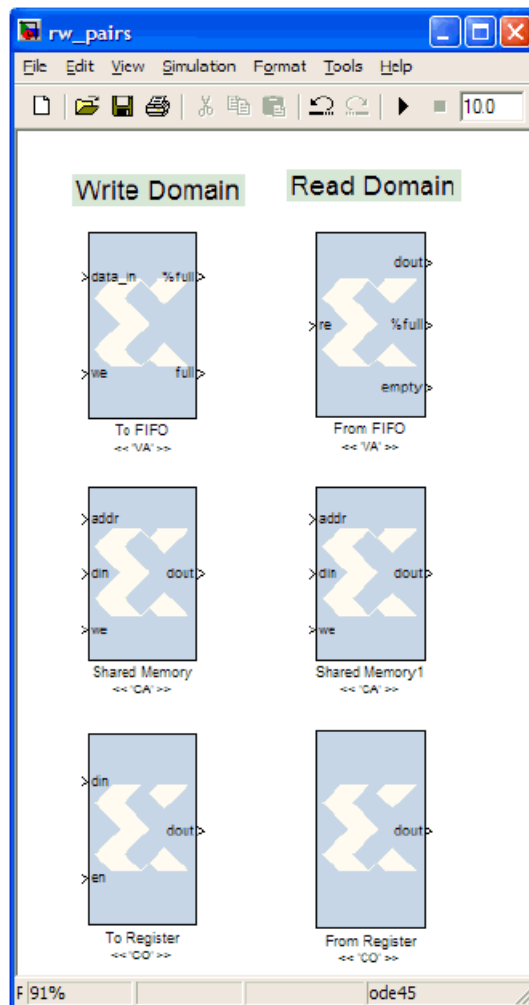

The `To FIFO` block is put in the domain in which it is to be written. The `From FIFO` is put in the domain in which it is to be read. The two blocks are linked by the name of the Shared memory name parameter. The FIFO is implemented in hardware using the Xilinx FIFO Generator core. Using FIFO blocks is the safest and easiest-to-use of the three blocks which cross domains and is the best for high-bandwidth, sequential data transfers.

A pair of Shared Memory blocks is implemented as embedded Xilinx dual-port block RAM core. The two blocks are linked by the name of the shared memory object. Each

member of the pair resides in a different domain. Because the RAM is a true dual-port, each domain may write to the RAM. Care must be taken, by means of semaphores or other logic, to ensure that two writes or a read and a write to the same address do not happen simultaneously. For example, if domain A writes to a memory location at the same time that domain B is reading from it, the data read may not be valid. The shared memory is implemented as a using Xilinx Dual Port Block Memory core to ensure that large memories are efficiently mapped across multiple BRAMs.

The `To Register` is put in the domain in which it is to be written, and the `From Register` in the domain from which it is to be read. The two blocks are linked by the name of the shared memory. The `To Register` may also be read synchronously in its own domain. The register may be of variable width and will synthesize as flip-flops. A 1-bit `To/From Register` pair will synthesize as a single flop.

**Note:** Crossing domains in this manner can be unsafe, and requires the use of metastability-reducing synchronization flops and semaphores for multiple-bit transfers. This technique should only be used when the hardware pitfalls are well-understood.

## Netlisting Multiple Clock Designs

Each clock domain should have its own subsystem in a System Generator design. The diagram below shows a two-domain design. The top-level block contains the Multiple Subsystem Generator block and two subsystems which each comprise a clock domain. Each subsystem has a System Generator token that sets the system clock period for that clock domain.

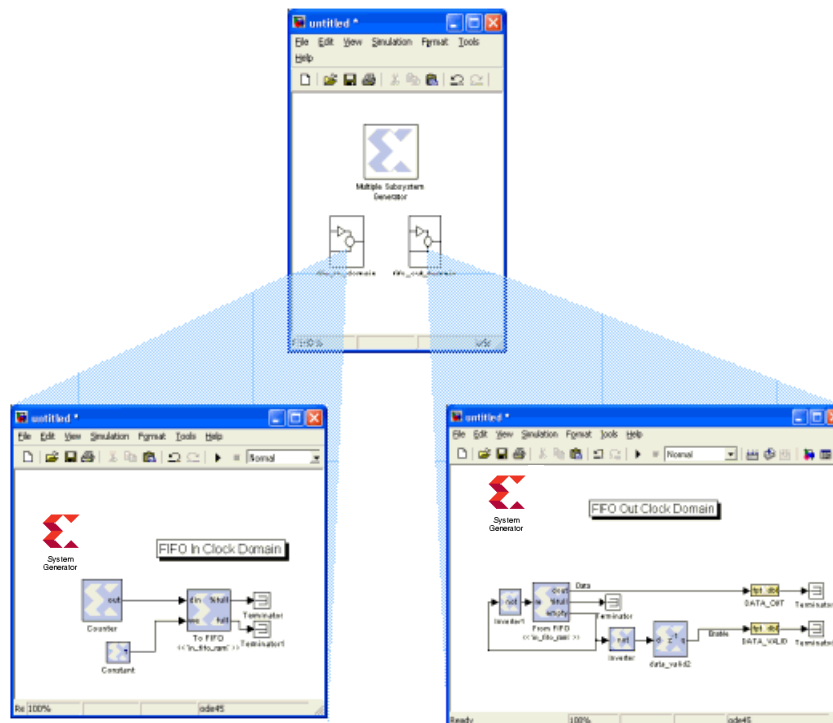

**Note:** The Multiple Subsystem Generator block does not support designs that include an EDK Processor block

The diagram below illustrates the concept of putting domain-crossing blocks into their own subsystem. When a multiple-domain design is netlisted, System Generator does the following:

- Creates an HDL file for Domain 0 (on the left), excluding the To FIFO block, and calls the netlister to create a black-box netlist delivered as an NGC file;
- Creates an HDL file for Domain 1 (on the right), excluding the From FIFO block, and calls the netlister to create a black-box netlist delivered as an NGC file;
- Invokes the Xilinx CORE Generator™ to produce a core for the FIFO block (middle);
- Creates a top-level HDL wrapper that instantiates three block components.

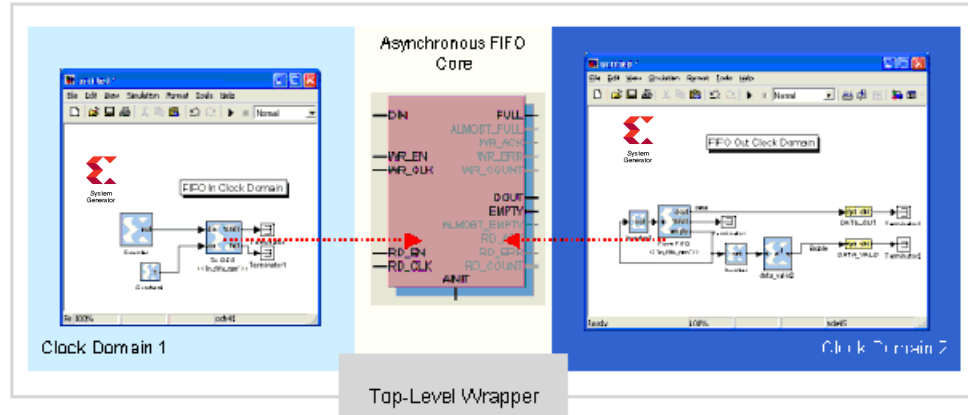

### Step-by-Step Example

This example shows how design hierarchy can be used to partition a System Generator design into multiple asynchronous clock islands. The example also demonstrates how Xilinx Shared Memory blocks may be used to communicate between these islands. Lastly, the example describes how the Multiple Subsystem Generator block can be used to netlist the complete multi-clock design.

1. From the MATLAB window, change directory to the following:  
`<ISE_Design_Suite_tree>/sysgen/examples/multiple_clocks/.`
2. Open the `two_async_clks` model from the MATLAB command window, and save it into a temporary directory of your choosing.

Subsystem hierarchy is used in this example to partition the design into two synchronous clock domains, to which you refer as domains A and B, that are internally synchronous to a single clock, but asynchronous relative to each other. The design includes two subsystems named `ss_clk_domainA` and `ss_clk_domainB`, which include logic associated with clock domains, A and B, respectively. The blocks inside the `ss_clk_domainA` subsystem operate in clock domain A while all blocks inside the `ss_clk_domainB` subsystem operate in a second clock domain, B.

The asynchronous islands in the example communicate with one another via a shared memory interface implemented using a pair of Xilinx [Shared Memory](#) blocks. The two Shared Memory blocks are distributed so that one block resides in domain `ss_clk_domainA` and the other resides in domain `ss_clk_domainB`. Both blocks specify the same shared memory object name, `bram_iface`. This allows the Shared Memory blocks to access a common address space during simulation. Note that in the diagram there is no physical connection shown between the two shared memory halves.



This is because the connection is implicitly defined by the fact that the two Shared Memory blocks specify the same shared memory object name and therefore, share an address space. When the two subsystems are wired together and translated into hardware, the shared memory blocks are moved from their respective subsystems and merged into a block RAM core. For more information on how this works, refer to the topic [Multiple Subsystem Generator](#).

The synchronous islands sample different input sources. Island `ss_clk_domainA` samples a sinusoid input, while `ss_clk_domainB` samples a saw-tooth wave input. Each subsystem writes its samples into opposite halves of the shared memory. Once an island has filled its half of memory, it reads samples from the other island's half. You can simulate the design to visualize of the model's behavior.

3. Press the Simulink **Start** button to simulate the design.
4. Open the scope to visualize the output signals.

Also shown in the output scope are the two clocks, `clk_A` and `clk_B`. At the default time scale, it is difficult to distinguish the two. Zoom in to get a more detailed view.

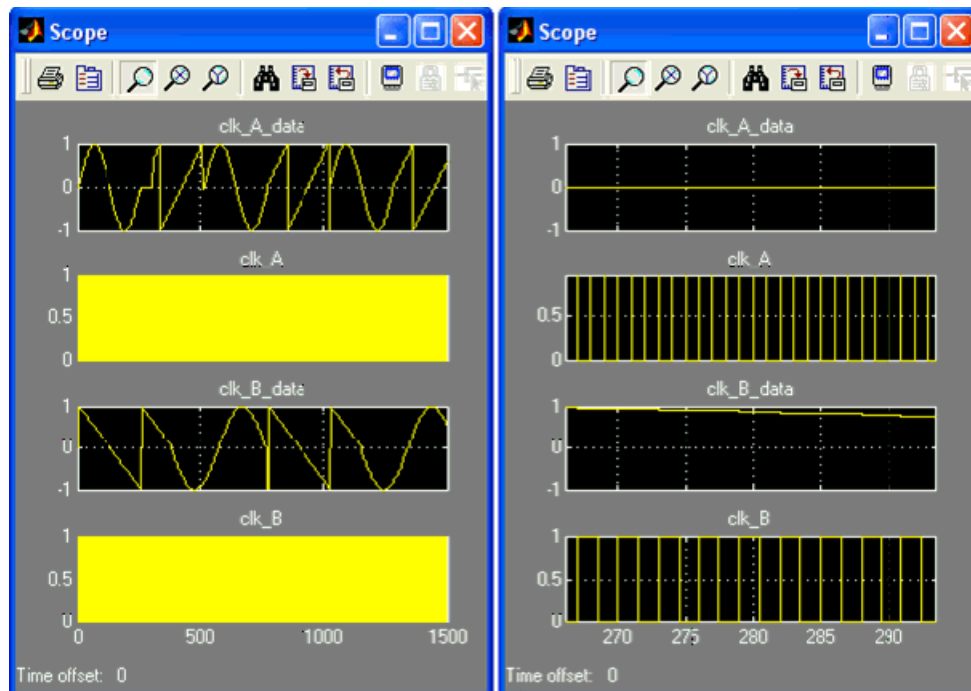

Notice that `clk_A` and `clk_B` have different periods and are out of phase with one another. Earlier, it was claimed that System Generator uses a single clock source per design. In the scope, you clearly see two different clocks. How is this possible?

The answer is in the hierarchical construction of the design. All blocks are buried in at least one level of hierarchy using subsystems. Because there is no System Generator token at the top level, you can consider each subsystem as a completely separate System Generator design (at least for the time being). In this model, you have effectively defined two clock domains by giving the `ss_clk_domainA` and `ss_clk_domainB` subsystems different Simulink system periods. This is allowed since you are treating these subsystems as separate System Generator designs. The clock probes in the `ss_clk_domainA` and `ss_clk_domainB` subsystems use the Simulink system periods in their respective



subsystems to determine their output, hence different system periods yield different system clocks.

Now consider the clocks defined by the System Generator token in the `ss_clk_domainA` and `ss_clk_domainB` subsystems.

- Open the System Generator token parameter dialog boxes inside the `ss_clk_domainA` and `ss_clk_domainB` subsystems.

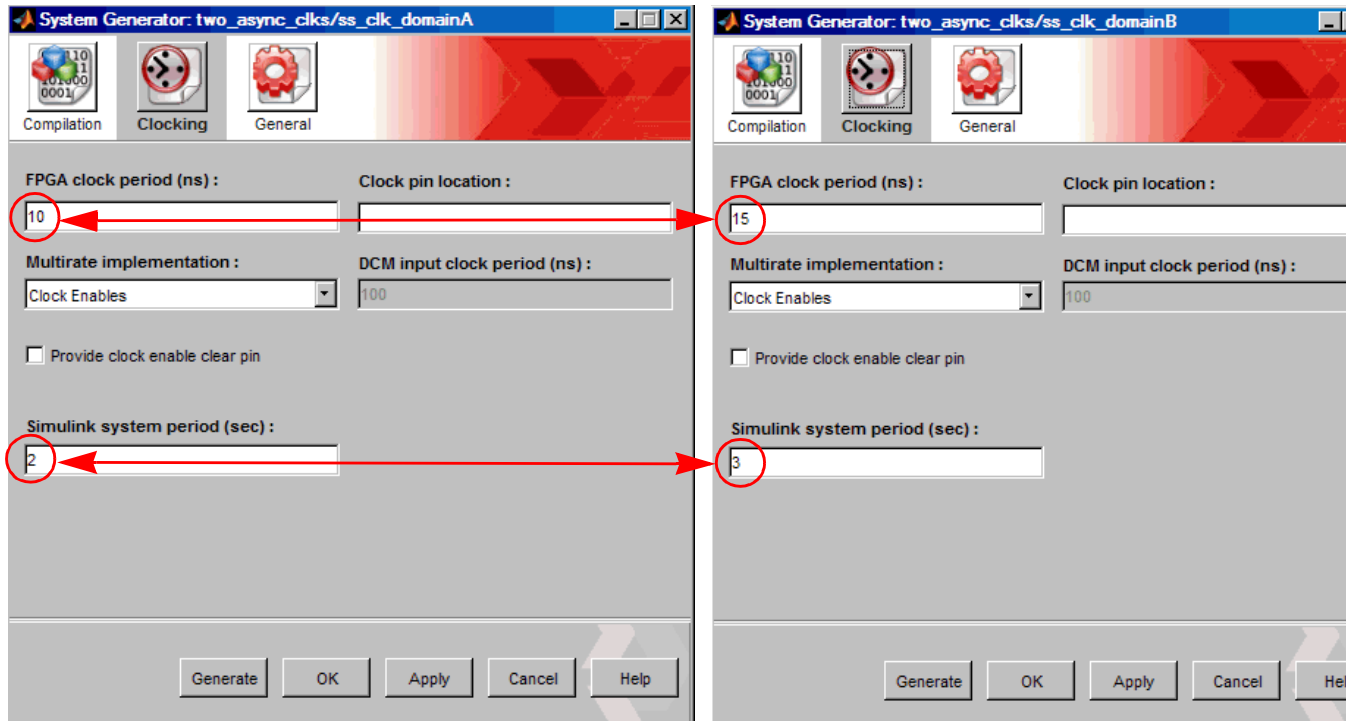

The System Generator token dialog box in the `ss_clk_domainA` subsystem defines an FPGA clock period of 10ns (i.e., a frequency of 100MHz). To simplify the sample period values in the model, the 10 ns clock is normalized to a Simulink system period value of 2 sec. In the `ss_clk_domainB` subsystem, an FPGA clock period of 15ns (i.e., a frequency 66.7 MHz) is defined. Normalizing this clock period gives us a Simulink system period value of 3 sec.

Because the two subsystems in this example implement multiple, synchronous, System Generator domains, you will use the Multiple Subsystem Generator block to wire the subsystems together into a single HDL top-level component that exposes two clock ports. When the Multiple Subsystem Generator translates a design into hardware, it generates each subsystem individually as an NGC netlist file. It also creates a top-level VHDL component or Verilog module that instantiates the subsystem netlist files as black boxes, and wires them together using shared memory cores as clock domain bridges.

You begin by using the Multiple Subsystem Generator block to netlist subsystems `ss_clk_domainA` and `ss_clk_domainB`.

- Open the Multiple Subsystem Generator dialog box by double clicking on the Multiple Subsystem Generator block included in the top-level of the `two_async_clocks` model.
- Pick a suitable target directory inside the Multiple Subsystem Generator dialog box. The default directory is `netlist`.

- Press the **Generate** button. You may leave the **Part**, **Synthesis Tool**, and **Hardware Description Language** fields as they are.

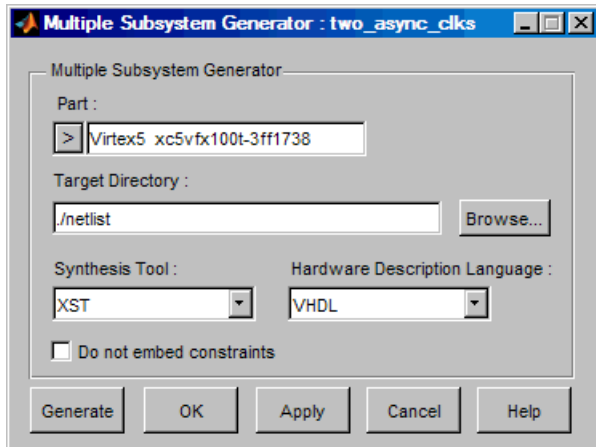

Once the Multiple Subsystem Generator block is finished running, it will display a message box indicating that generation is complete. It is worthwhile to take a look at the generated results.

- `cd` into the design's target directory, `netlist`.

There are two NGC files in this directory: `ss_clk_domaina_cw.ngc` and `ss_clk_domainb_cw.ngc`. These files store the netlist and constraints information corresponding to the subsystems `ss_clk_domaina` and `ss_clk_domainb`. Note that these NGC files include the clock wrapper layer logic associated with each subsystem. This is necessary to ensure that any clock enable logic required by a multirate design is included in netlist file. By using the clock wrapper layer of a design, the corresponding clock driver components are automatically included in the netlist.

Also in this directory is a dual port memory core netlist file named `dual_port_block_memory_virtex2_6_1_ef64ec122427b7be.edn`. This core provides the hardware implementation for the Shared Memory blocks used in the original design. The width and depth of the memory are based on values used in the Shared Memory block configurations.

You will now take a look at the top-level HDL component that the Multiple Subsystem Generator block produced for the design.

- Open the `two_async_clks.vhd` file in a text editor.

This component defines the HDL top-level for the `two_async_clks` model.

```
entity two_async_clks is
  port (
    din_a: in std_logic_vector(7 downto 0);
    din_b: in std_logic_vector(7 downto 0);
    ss_clk_domaina_cw_ce: in std_logic := '1';
    ss_clk_domaina_cw_clk: in std_logic;
    ss_clk_domainb_cw_ce: in std_logic := '1';
    ss_clk_domainb_cw_clk: in std_logic;
    dout_a: out std_logic_vector(7 downto 0);
    dout_b: out std_logic_vector(7 downto 0)
  );
end two_async_clks;
```

There are several interesting things to notice about the port interface. First, the component exposes two clock ports (shown in **bold** text). The two clock ports are named after the subsystems from which they are derived (e.g., *ss\_clk\_domaina*), and are wired to their respective subsystem NGC netlist files. Also note that the top-level ports of each subsystem (e.g., *din\_a* and *dout\_a*) appear as top-level ports in the port interface.

The Multiple Subsystem Generator block does not generate circuitry (e.g., a DCM) to generate multiple clock sources. You may modify the top-level HDL component to include the circuitry, or instantiate the top-level HDL as a component in a separate wrapper that includes the clocking circuitry.

## Creating a Top-Level Wrapper

If you decide to create a top-level HDL wrapper for your multi-clock System Generator design, it should perform the following tasks at a minimum:

- Instantiate the System Generator top-level component along with other wrapper logic (e.g., a DCM);
- Wire the System generator component to the other logic;
- Create a new top-level port map which supersedes that from the System Generator component.

The following is an example of making a top-level HDL component to instantiate clocking circuitry. In this example, you take the output created when the example from the previous topic is generated using the Multiple Subsystem Generator block. The resulting System Generator design is called *two\_async\_clks* and the top-level HDL component is called *top\_wrapper* (for the case of VHDL synthesis).

Because the clock lines and main clock enables are inferred, the names of the clocks and clock enables (with the *\_ce* and *\_clk* suffixes above) are generated automatically by putting suffixes on the subsystem names from which the clocks are inferred. The other port names, such as *dout\_a*, are taken directly from the names given to the gateway blocks in the System Generator design.

An example VHDL top-level wrapper to instantiate the entity *two\_async\_clks*, with deletions made for clarity, is provided below. Note that the wrapper uses a DCM component to generate the two clocks required by the System Generator design.

```
-----
-----
-- top_wrapper.vhd
-- Example Top Level Wrapper
--
-- This is an example top-level wrapper for instantiating a System
Generator
-- design along with a DCM. In this example, the DCM connects the two
clock
-- inputs of the System Generator block ('two_async_clks') to two
buffered
-- outputs of the DCM, namely, CLK0 and CLKFX. CLK0 is the same
frequency
-- and phase as the input clock, and CLKFX is configured to be twice the
-- frequency of the input clock.
-----
-----
library IEEE;
library unisim;
use IEEE.std_logic_1164.all;
```

```

use unisim.vcomponents.all;
entity top_wrapper is
  port (
    clk : in std_logic;
    din_a : in std_logic_vector(7 downto 0);
    din_b : in std_logic_vector(7 downto 0);
    dout_a : out std_logic_vector(7 downto 0);
    dout_b : out std_logic_vector(7 downto 0)
  );
end top_wrapper;

architecture structural of top_wrapper is
  -----
  -- SysGen Model Component Declaration
  -----
  component two_async_clks
  port (
    din_a: in std_logic_vector(7 downto 0);
    din_b: in std_logic_vector(7 downto 0);
    ss_clk_domaina_cw_ce: in std_logic := '1';
    ss_clk_domaina_cw_clk: in std_logic;
    ss_clk_domainb_cw_ce: in std_logic := '1';
    ss_clk_domainb_cw_clk: in std_logic;
    dout_a: out std_logic_vector(7 downto 0);
    dout_b: out std_logic_vector(7 downto 0)
  );
end component;
component bufg
port(i: in std_logic;
    o: out std_logic);
end component;
  -----
  -- DCM Component Declaration
  -----
  component dcm
  -- synopsys translate_off
  generic (clkout_phase_shift : string := "fixed";
    dll_frequency_mode : string := "low";
    duty_cycle_correction : boolean := true;
    clkdv_divide : real := 3;
    clkfx_multiply : integer := 2;
    clkfx_divide : integer := 1);
  -- synopsys translate_on
  port (clkkin : in std_logic;
    clkfb : in std_logic;
    dssen : in std_logic;
    psincdec : in std_logic;
    psen : in std_logic;
    psclk : in std_logic;
    rst : in std_logic;
    clk0 : out std_logic;
    clk90 : out std_logic;
    clk180 : out std_logic;
    clk270 : out std_logic;
    clk2x : out std_logic;
    clk2x180 : out std_logic;
    clkdv : out std_logic;
    clkfx : out std_logic;
    clkfx180 : out std_logic;
  );
end component;

```

```

        locked : out std_logic;
        psdone : out std_logic;
        status : out std_ulogic_vector(7 downto 0));
end component;
-----
-- DCM Attributes
-----
attribute dll_frequency_mode : string;
attribute duty_cycle_correction : string;
attribute startup_wait : string;
attribute clkdv_divide : string;
attribute clkfx_multiply : string;
attribute clkfx_divide : string;
attribute clkin_period : string;

attribute duty_cycle_correction of dcm0 : label is "true";
attribute startup_wait of dcm0 : label is "false";
attribute dll_frequency_mode of dcm0 : label is "low";
attribute clkdv_divide of dcm0 : label is "3";
attribute clkfx_multiply of dcm0 : label is "2";
attribute clkfx_divide of dcm0 : label is "1";
attribute clkin_period of dcm0 : label is "10";

signal clk0unbuf : std_logic;
signal clk0buf : std_logic;
signal clkfxbuf : std_logic;
signal clk2xunbuf : std_logic;
signal clkfxunbuf : std_logic;
signal clkdvunbuf : std_logic;
signal clkdvbuf : std_logic;
signal ff1,ff2,ff3,ff4 : std_logic;
signal dcm_rst : std_logic;
signal intlock : std_logic;

-----
-----
-- The top level instantiates the SysGen design, a DCM, and two BUFs.
-- The DCM generates two clocks of different frequencies.
-- These two clocks are used to drive the two different clock domains
-- in the SysGen block.
-----
-----
begin
  dcm0: dcm
    -- synopsys translate_off
    generic map (dll_frequency_mode => frequency_mode,
                 clkdv_divide => clkdv_divide_generic,
                 clkfx_multiply => clkfx_multiply_generic,
                 clkfx_divide => clkfx_divide_generic)
    -- synopsys translate_on
    port map (clkin => clk,
              clkfb => clk0buf,
              dssen => '0',
              psincdec => '0',
              psen => '0',
              psclk => '0',
              rst => dcm_rst,
              clk0 => clk0unbuf,
              clk2x => clk2xunbuf,

```

```

        clkfx => clkfxunbuf,
        clkdv => clkdvunbuf,
        locked => intlock);
bufg_clk0: bufg
port map (i => clk0unbuf,
         o => clk0buf);
bufg_clkfx: bufg
port map (i => clkfxunbuf,
         o => clkfxbuf);

-----
-- This is the DCM reset. It is a four-cycle shift register used to
-- hold the DCM in reset for a few cycles after programming.
-----
flop1: FDS port map (D => '0', C => clk, Q => ff1, S => '0');
flop2: FD port map (D => ff1, C => clk, Q => ff2);
flop3: FD port map (D => ff2, C => clk, Q => ff3);
flop4: FD port map (D => ff3, C => clk, Q => ff4);
dcm_rst <= ff2 or ff3 or ff4;

-----
-- SysGen Component Port Mapping
-- One clock input is being connected to clk0 of the DCM,
-- and the other clock is being connected to clkfx.
-----
two_async_clks: two_async_clks
port map (
    din_a => din_a,
    din_b => din_b,
    ss_clk_domaina_cw_ce => '1',
    ss_clk_domaina_cw_clk => clk0buf,
    ss_clk_domainb_cw_ce => '1',
    ss_clk_domainb_cw_clk => clkfxbuf,
    dout_b => dout_b);
end structural;

```

# Using ChipScope Pro Analyzer for Real-Time Hardware Debugging

The integration of ChipScope™ Pro in the System Generator flow allows real-time debugging at system speed. By inserting a ChipScope block into your System generator design, you can debug and verify all the internal signals and nodes within your FPGA.

## ChipScope Pro Overview

The increasing density of FPGA devices has rendered attaching test probes to these devices impractical. The ChipScope™ Pro tools integrate key logic analyzer hardware components with the target design inside of a Xilinx device. The ChipScope Pro tools communicate with these components during system operation and in effect provide the designer with a logic analyzer for nodes inside the Xilinx FPGA. ChipScope gives you a deep trace memory, fast clock speeds and multiple trigger options, which can vary in complexity. You can easily capture and view signal activity inside your FPGA without having to dedicate critical logic space, come up with complex capture schemes, or allocate additional I/O pins. Data samples are captured based on user-defined trigger conditions and stored in internal block memory. All control and data transfer is done via the JTAG port eliminating the need to drive data off-chip using I/O pins.

Please refer to the following Web page for further details on ChipScope Pro:

[http://www.xilinx.com/ise/optional\\_prod/cspro.htm](http://www.xilinx.com/ise/optional_prod/cspro.htm)

## Tutorial Example: Using ChipScope in System Generator

**Note:** This tutorial assumes that you have already installed and configured both the hardware and software required to run an ML506 platform. For installation and configuration information, refer to the ML506 documents located at the following web address:

<http://www.xilinx.com/products/boards/ml506/docs.htm>

This tutorial shows how to modify a Simulink model to integrate the ChipScope™ block and how to select the data to be captured and viewed for debugging. The steps are as follows:

1. From the MATLAB console, change the directory to `<sysgen_path>/examples/chipscope/example1`. The following files are located in this directory:
  - ◆ `chipscope_ex1.mdl` – Your working model.
  - ◆ `chipscope_ex1_soln.mdl` – Solution model, including the ChipScope block.
2. Open the `chip_ex1.mdl` model from the MATLAB console. This model represents a simple usage model of a DDS Compiler block that will produce sine and cosine output waveforms. Both sine and cosine output waveforms will later be connected to a Chipscope block, enabling you to debug and verify the System Generator block by probing and plotting the waveforms.

- The 8-bit Counter is used to trigger ChipScope. The most significant bit is extracted with a slice block and can be used for a variety of purposes such as driving an LED on the ML506 Platform for this exercise.

## ChipScope Pro Tutorial Example

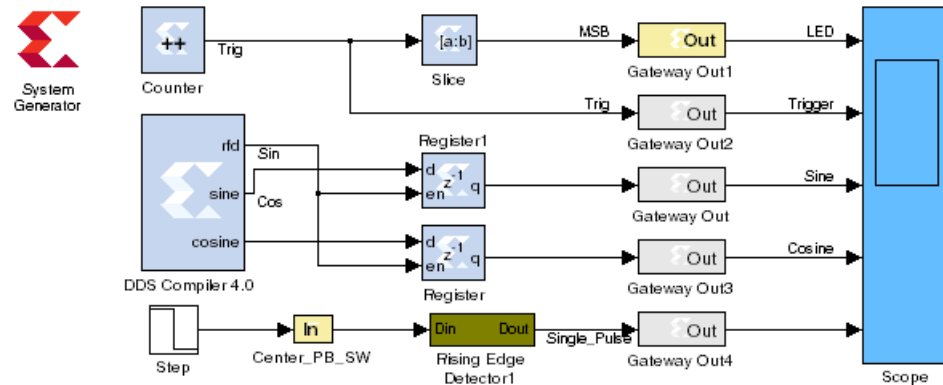

- Simulate the model by clicking on the **Start simulation** Icon . At this point, without modifying the model, you should be able to see the following plot.

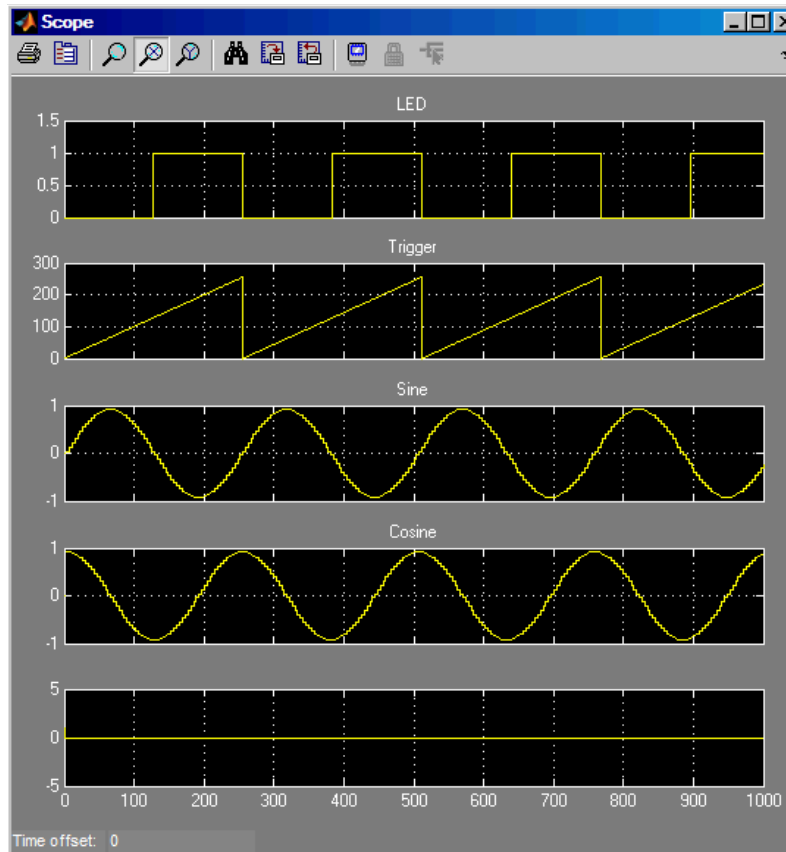

- The first plot represents the most significant bit of the 8-bit counter. The MSB becomes 1 when the counter output is within the range of 128 through 255.
- The second plot represents the full output of the counter.



- ◆ The third and forth plots show the output sine and cosine respectively.
- 5. Integrate ChipScope into the Simulink model. The ChipScope block can be found in the Simulink Library Browser in the Xilinx Blockset, under the Tools library. While holding down the left mouse button, select the ChipScope block and drag it into the open area in the lower-right corner of the Simulink model.
- 6. Double click on the ChipScope block in order to set the following parameters:
  - ◆ **Number of trigger ports:** Multiple trigger ports allow a larger range of events to be detected and can reduce the number of values that must be stored. Up to 16 trigger ports can be selected. In this example, only one is used.
  - ◆ **Display settings for trigger port:** For each trigger port, the number of match units and the match type need to be set. The pulldown menu displays options for a particular trigger port. For N ports, the display options for trigger port 0 to N-1 can be shown. In this example, there is one Trigger port named Trig0. This option should therefore be set to 0.
  - ◆ **Number of match units:** Using multiple match units per trigger port increases the flexibility of event detection. One to four match units can be used in conjunction to test for a trigger event. In this example, this option should be set to 1 since you are only checking for one condition (i.e., the 8-bit counter value). You will set the trigger value at run-time in the ChipScope Pro Analyzer.
  - ◆ **Match type:** This option can be set to one of the following six types:
    1. **Basic:** performs = or <> comparisons
    2. **Basic With Edges:** in addition to the basic operations high/low, low/high transitions can also be detected
    3. **Extended:** performs =, <>, >,<, <=, >= comparisons
    4. **Extended With Edges:** in addition to the extended operations, high/low, low/high transitions can also be detected.
    5. **Range:** performs =, <>, >, >=, <, <=, in range, not in range comparisons
    6. **Range With Edges:** in addition to the range operations, high/low, low/high transitions can also be detected. In this example, set the Match Type to **Basic with Edges**.
  - ◆ **Number of data ports:** Up to 256 bits can be captured per sample. This means that the sum over all ports of the bits used per port must be less than or equal to 256. System Generator propagates the data width automatically; therefore, only the number of data ports needs to be specified. In this example, you want to view the sine and cosine and trig\_counter, hence you enter 3.
  - ◆ **Depth of capture buffer:** The depth of the capture buffer is a power of 2, up to 16384 samples. In this example, set the depth to 1024 (min value required for V5).

After parameterization the ChipScope™ GUI should look like the following:

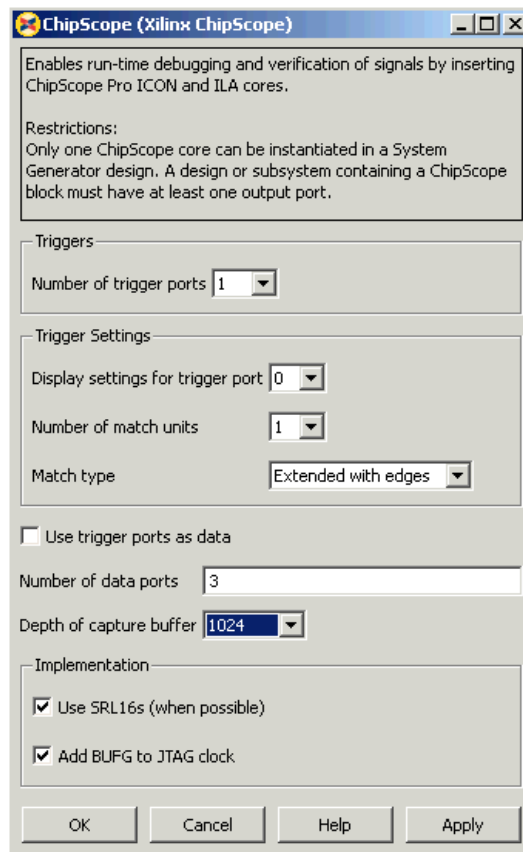

7. Connecting the ChipScope Block

The signal used to trigger ChipScope is the counter output. The two buses that you want to probe are the sine and cosine from the Sine/Cosine table. Connect the signals appropriately as shown on the following figure:

ChipScope Pro Tutorial Example

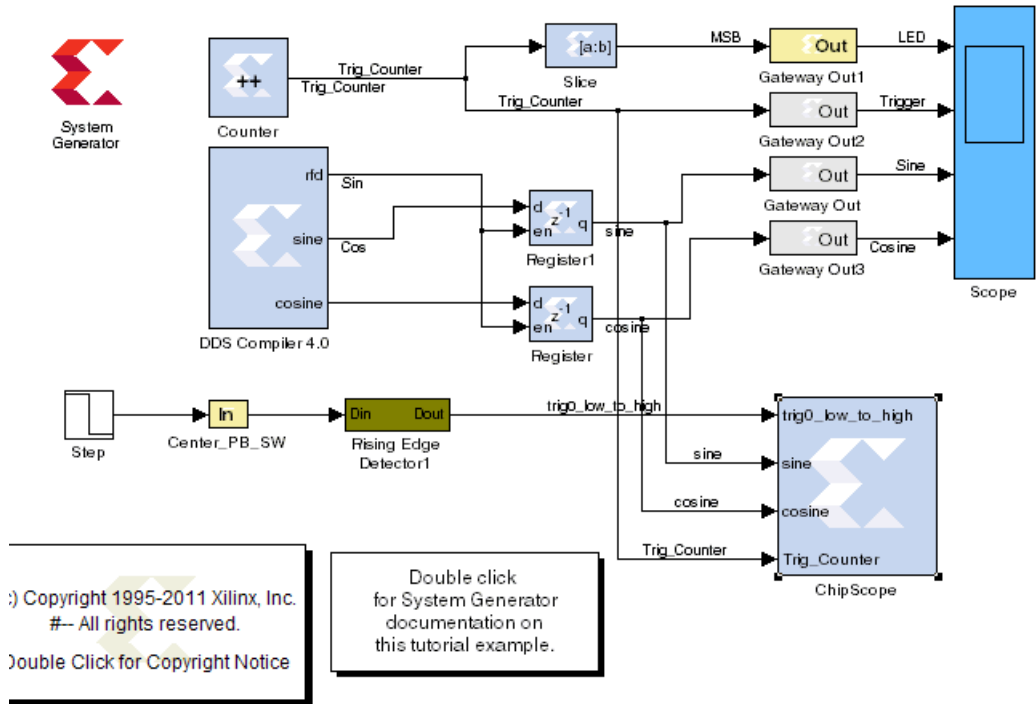

Note that the names of the ports on the ChipScope block are specified by names given to the signals connected to the block, e.g. Sine and Cosine.

8. Location Constraints

Now that the design is fully implemented and simulates correctly, the next step is to prepare it for connection to the hardware target. Although it can work on any hardware platform, the process is described for the ML506.

Two pins need to be locked down in this design: The LED and the clock pin.

- ◆ **LED Pin:** Double click on the Gateway Out1 block, select Specify IOB Location constraints and type in {'AE24'} (note the need for single quotes).

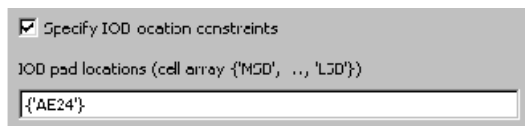

- ◆ **Clock Pin:** Double click on the System Generator token, set the clock period to 10ns and the clock pin location to AH15.

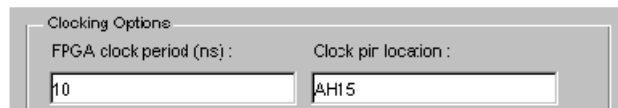

If you are using a different board, the pin locations should be modified appropriately.

#### 9. System Generator GUI settings

The last two parameters that should be updated before generating a bitstream are the target device and the compilation target.

- ◆ Double click on the System Generator token and verify the parameter settings as follows:

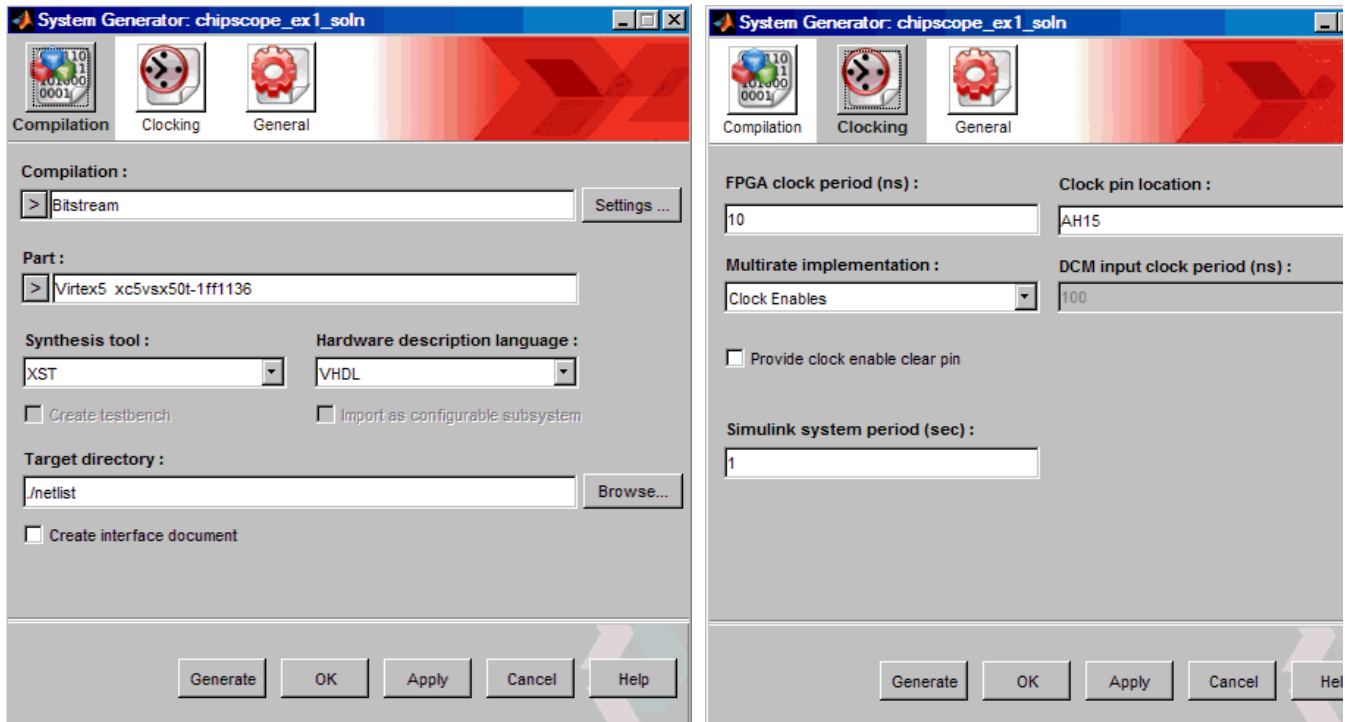

#### 10. Bitstream Generation

Xilinx System Generator software automatically calls both the Core Generator™ and ChipScope generator to create the netlist and cores. In addition, when the **Bitstream** target is selected, a configuration bitstream is created.

- ◆ Create a bitstream by pressing the **Generate** button.
- ◆ The Core Generator is automatically called to generate the Sine/Cosine table and Counter netlists. ChipScope generator is called to create an Integrated Logic Analyzer (ILA) core and an ICON core to communicate with the ChipScope Pro software via the JTAG port.

## Real-Time Debug

The next step is to run the design on the ML506 platform and view the probed outputs with the ChipScope™ Pro Analyzer.

1. Connect one end of the Parallel Cable IV or Platform USB cable to the General JTAG connector (J1) on the ML506 board. Connect the other end to your computer.

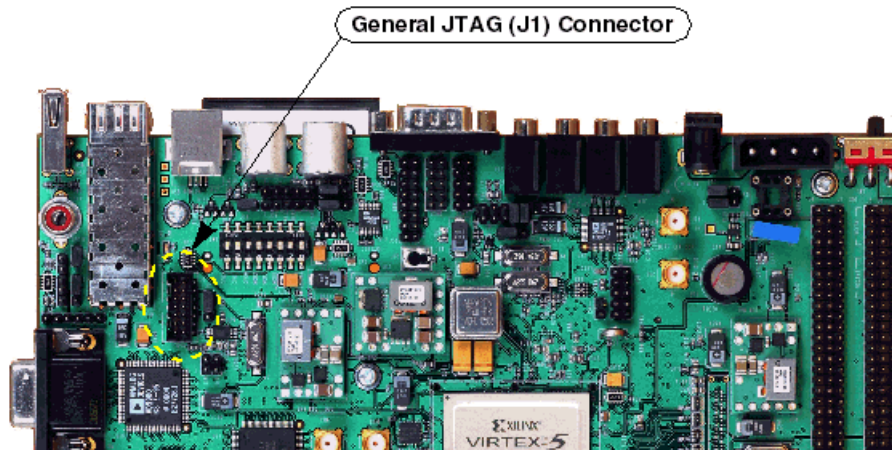

2. Launch ChipScope Pro Analyzer
  - ◆ Open the JTAG Chain by clicking on the following icon , or by selecting **JTAG Chain > Xilinx Platform USB Cable**. You should see the following table of the JTAG Chain Device Order. After observing the order, click **OK**

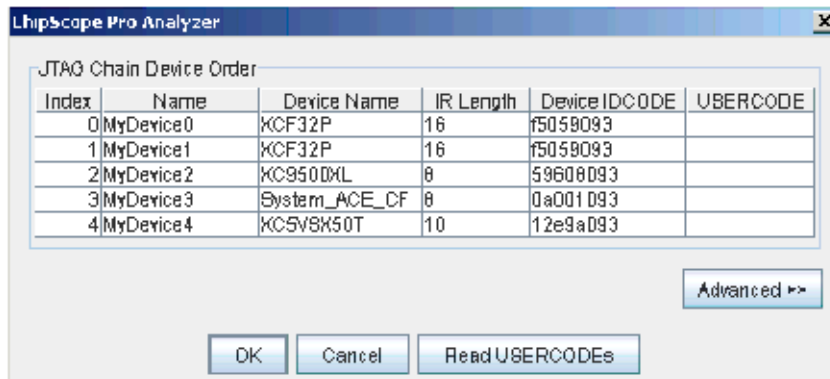

3. Configure the FPGA
  - ◆ Under the New Project Window, right click on **Device 4 > Configure > Select New File**. At this point, you need to look for the bitstream which was generated in step 10 of the previous section ( ./bitstream/chip\_cw.bit). After configuration, you should see an INFO message at the bottom of the ChipScope Analyzer window “Found 1 Core Unit in the JTAG chain”.

4. Import ChipScope Project File

System Generator creates a project file for ChipScope in order to group data signals into buses. A bus is created for each data port so that it can be viewed in the same manner (sign and precision) in which it was viewed in the Simulink environment.

Load this project file by going under **File > Import > Select New File**, and select <ISE\_Design\_Suite\_tree>/sysgen/examples/chipscope/netlist/temp/chip\_chipscope.cdc.

5. Plot the Sine Waves

- ◆ In the New Project window, under **Device 4**, double click on **Trigger Setup** to bring up the setup window but do not set it yet at this step.
- ◆ In the New Project window, under Device \$ > Unit 0 MyILA0 (ILA), double click on **Bus Plot**.

A Bus Plot window appears. Select cosine and sine in the Bus Selection section, and then arm the trigger by clicking the  button. Since you have not yet set any trigger conditions, values are captured immediately. Both the sine and cosine appear as shown below. You can change the display option to represent the waveforms with points, lines, or both.

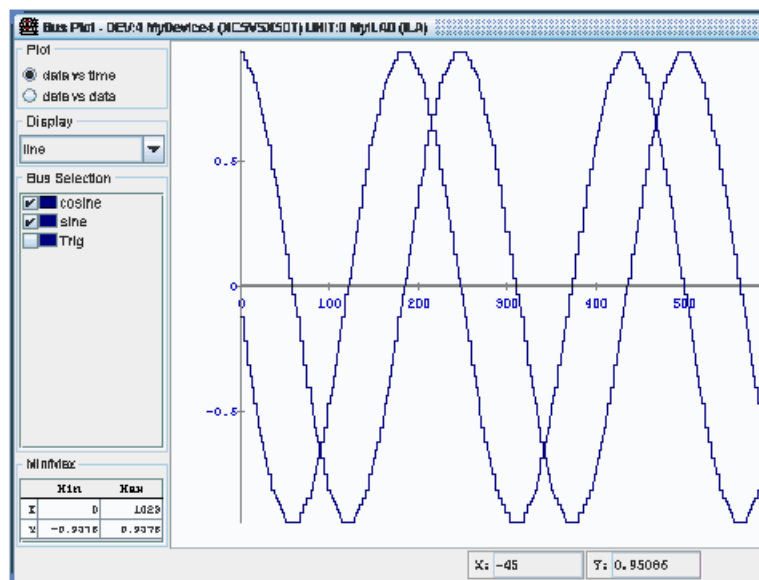

6. Setup Trigger

In the Trigger Setup window, change the current X value with all 1s. A low-to-high pulse is used for this trigger and can be manually triggered by pushing the center PB SW as shown below. ChipScope starts capturing data when it detects a low-to-high pulse. Earlier, you setup the buffer to 1024 so that up to 1024 data points can be captured and visualized in ChipScope.

Re-capture the data by clicking on the  button and you should see this screen below indicating that the ChipScope is waiting for a qualified trigger signal before capturing and displaying data.

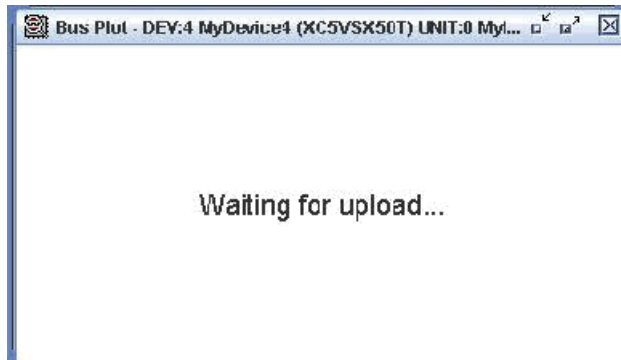

This method of triggering is useful if you want a full control of when you like to capture the data. This is accomplished by connecting one of the PB switches to a single shot (Rising Edge Detector) circuit. The center PB switch (AJ6, SW14) is used for this exercise.

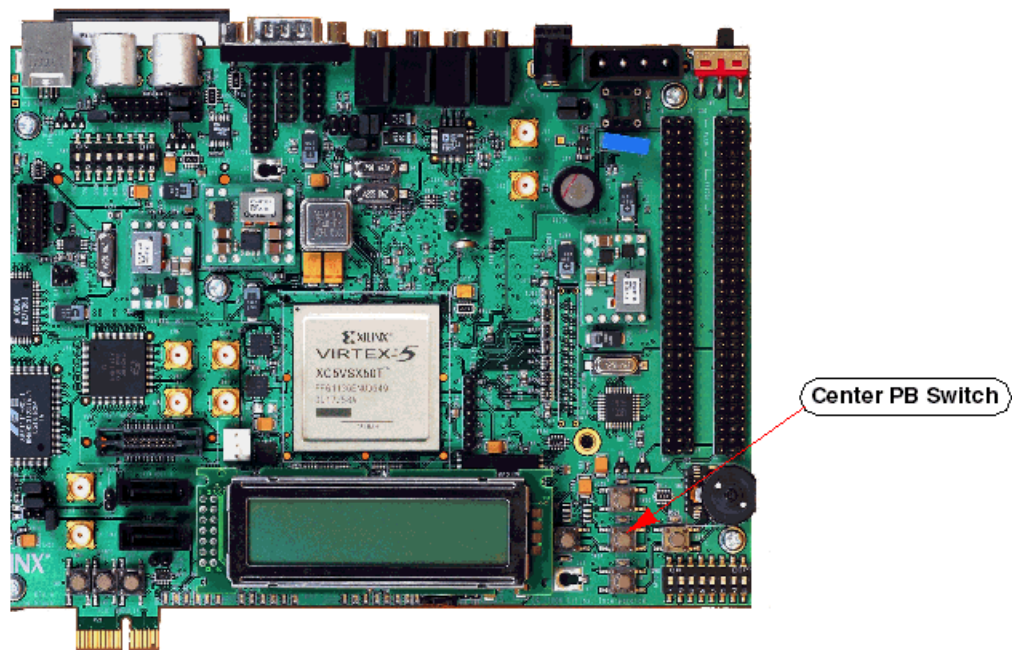



## Importing Data Into the MATLAB Workspace From ChipScope

Now you can export the data captured by ChipScope™ back into the MATLAB workspace.

1. Export data from ChipScope Pro Analyzer
  - ◆ **Select File > Export** option from within ChipScope Pro Analyzer. Select ASCII format and choose **Bus Plot Buses** to export. Press the **Export** button and save the file as `sinecos.prn`.
2. Start MATLAB and change the current working directory to the location where you saved `sinecos.prn`.
  - ◆ Type `xlLoadChipScopeData('sinecos.prn');` This loads the data from the `.prn` file into the MATLAB workspace. In the workspace there are two new arrays named `Sin` and `Cos`.
3. You can plot the values using the MATLAB plot function.
  - ◆ Type: `plot(1:1024, sine, 1:1024, cosine)` and the following plot is generated:

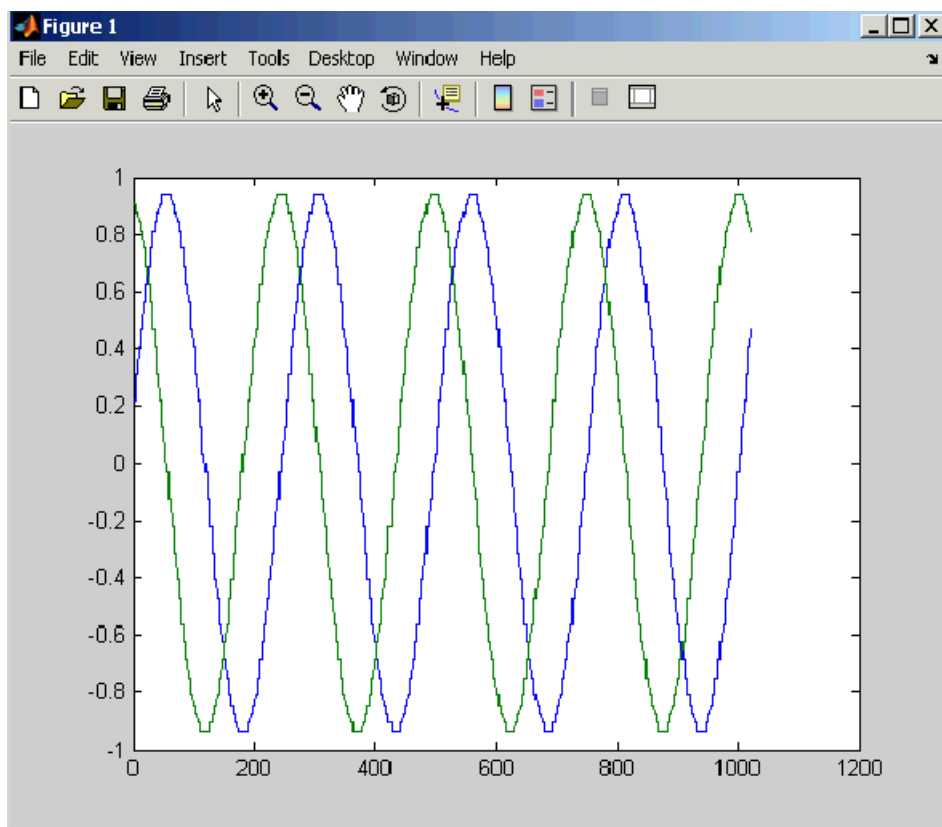



## Tutorial Example: Using ChipScope Pro Analyzer with JTAG Hardware Co-Simulation

### Design Description

The following Simulink design model is used to demonstrate an integrated design flow between ChipScope Pro Analyzer and JTAG Hardware Co-simulation. The model contains a DDS Compiler block and a ChipScope block. The `phase_in` input port of the DDS Compiler block is accumulated phase variations, which are in turn used to adjust sine and cosine output waveforms. These outputs are then internally captured by ChipScope Pro Analyzer in real time.

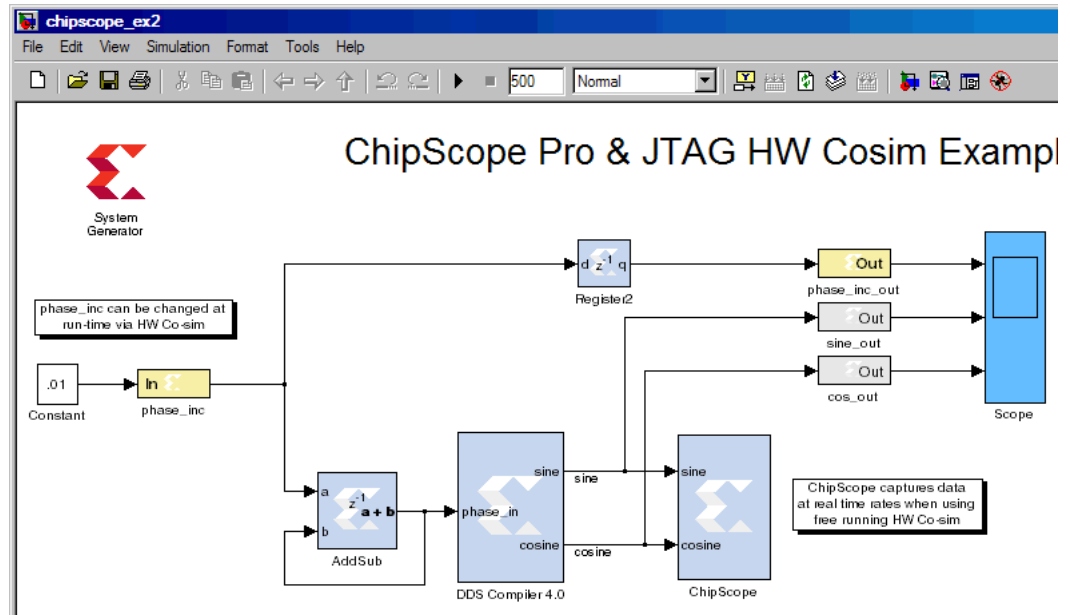

### Setup the SP601 Hardware Co-Simulation Platform

Setup the SP601 Platform for JTAG Hardware Co-Simulation as described in the topic [Installing an SP601/SP605 Board for JTAG Hardware Co-Simulation](#).

### Generate a Bitstream File

1. Open `<sysgen_path>/examples/chipscope/example2/chipscope_ex2.mdl` and generate a netlist targeting SP601 JTAG
2. Save the current Simulink model as `chipscope_ex2_hwcs.mdl`
3. Replace all the Simulink blocks with the JTAG HWCS block that you just generated except for input and output gateways

4. Add a Simulink Slider Gain block to attenuate phase inc/dec changes and your model should look similar to the figure below:

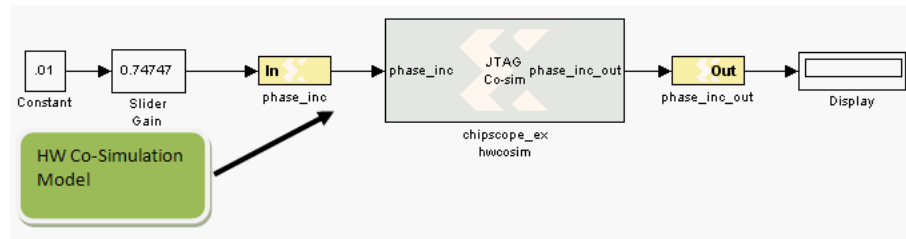

## Benefits

One of the main benefits for this feature is the ability capture and examine the System Generator data in real time. The data can be captured directly from external IO pins via non-memory-mapped IO such as Analog to Digital without having to capture the data onto Shared Memory of FIFO and then read it onto Simulink. In this particular example, ChipScope captures data at real time rates when using Free Running, HW Co-simulation mode.

## How to Iterate a Design between System Generator for DSP and ChipScope Pro Analyzer

### In Simulink

Press play on the Simulink model to start hardware co-simulation to download the bitstream

### In ChipScope Pro Analyzer

1. Start the ChipScope Pro Analyzer from the Windows **Start** menu
2. From the pulldown menu: **File > Open Project...** and select `chipscope_ex2_chipscope.cpj`
3. From the pulldown menu: **JTAG Chain > Xilinx Platform USB Cable...** then press **OK**
4. From the toolbar: Press the **Trigger Now** button (i.e. T! button)

**Note:** You should be able to observe the following output waveform from the Bus Plot

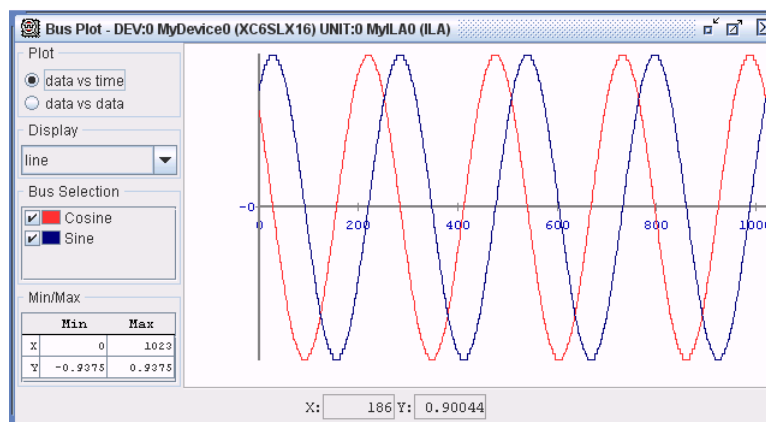

### In Simulink

1. Press **Play** and change the Slider Gain setting to change the frequency of the DDS
2. Press **Pause** in Simulink

### In ChipScope Pro Analyzer

1. Press the **Trigger Now** button again to capture the new Sine and Cosine waves that are running at a different frequency

## AXI Interface

### Introduction

AMBA® AXI™4 (Advanced eXtensible Interface 4) is the fourth generation of the AMBA interface defined and controlled by ARM®, and has been adopted by Xilinx as the next-generation interconnect for FPGA designs. Xilinx and ARM worked closely to ensure that the AXI4 specification addresses the needs of FPGAs.

AXI is an open interface standard that is widely used by many 3rd-party IP vendors since it is public, royalty-free and an industry standard.

The AMBA AXI4 interface connections are point-to-point and come in three different flavors: AXI4, AXI4-Lite and AXI4-Stream.

- AXI4 is a memory-mapped interface which support burst transactions
- AXI4-Lite is a lightweight version of AXI4 and has a non-bursting interface
- AXI4-Stream is a high-performance streaming interface for unidirectional data transfers (from master to slave) with reduced signaling requirements (compared to AXI4). AXI4-Stream supports multiple channels of data on the same set of wires.

In the following documentation, AXI4 refers to the AXI4 memory map interface, and AXI4-Lite and AXI4-Stream each refer to their respective flavor of the AMBA AXI4 interface. When referring to the collection of interfaces, the term AMBA AXI4 shall be used.

The purpose of this section is to provide an introduction to AMBA AXI4 and to draw attention to AMBA AXI4 details with respect to System Generator. For more detailed information on the AMBA AXI4 specification please refer to the Xilinx AMBA-AXI4 documents found in <http://www.xilinx.com/ipcenter/axi4.htm>.

### AXI4 Support in System Generator

AXI4 (memory-mapped) support in System Generator is available through the EDK Processor block found in the System Generator block set. The EDK Processor block allows users to connect hardware circuits created in System Generator to a Xilinx Microblaze processor; users have the option to connect to the processor via a PLB46 or AXI4 interface.

Users need not be fluent in AXI4 nomenclature when using this flow because the EDK Processor block presents to the users a bus-agnostic interface that is memory centric. Users need only create hardware that utilize Shared Registers, Shared FIFOs and Shared Memories and The EDK Processor block will take care of connecting these memories to the chosen interface.

Please refer to the System Generator documentation for more information on Hardware and Software Co-design refer to the topic titled [Integrating a Processor with Custom Logic](#) and [EDK\\_Processor](#) block.

## AXI4-Stream Support in System Generator

The 3 most common AXI4-Stream signals are TVALID, TREADY and TDATA. Of all the AXI4-Stream signals, only TVALID is denoted as mandatory, all other signals are optional. All information-carrying signals propagate in the same direction as TVALID; only TREADY propagates in the opposite direction.

Since AXI4-Stream is a point-to-point interface, the concept of master and slave interface is pertinent to describe the direction of data flow. A master produces data and a slave consumes data.

### Naming conventions

AXI4-Stream signals are named in the following manner:

```
<Role>_<ClassName>[_<BusName>]_[<ChannelName>]<SignalName>
```

For instance:

```
m_axis_tvalid
```

Here *m* denotes the Role (master), *axis* the ClassName (AXI4-Stream) and *tvalid* the SignalName

```
s_axis_control_tdata
```

Here *s* denotes the Role (slave), *axis* the ClassName, *control* the BusName which distinguishes between multiple instances of the same class on a particular IP, and *tdata* the SignalName.

### Notes on TREADY/TVALID handshaking

The TREADY/TVALID handshake is a fundamental concept in AXI to control how data is exchanged between the master and slave allowing for bidirectional flow control. TDATA, and all the other AXI-Streaming signals (TSTRB, TUSER, TLAST, TID, and TDEST) are all qualified by the TREADY/TVALID handshake. The master indicates a valid beat of data by the assertion of TVALID and must hold the data beat until TREADY is asserted. TVALID once asserted cannot be de-asserted until TREADY is asserted in response (this behavior is referred to as a “sticky” TVALID). **AXI also adds the rule that TREADY can depend on TVALID, but the assertion of TVALID cannot depend on TREADY.** This rule prevents circular timing loops. The timing diagram below provides an example of the TREADY/TVALID handshake.

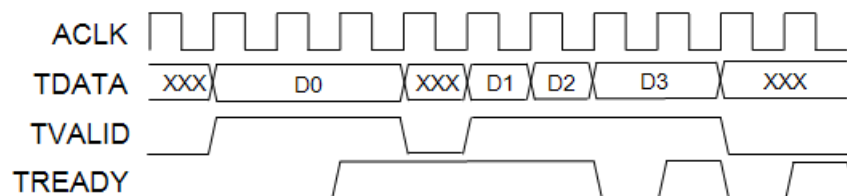

### Handshaking Key Points

- A transfer on any given channel occurs when both TREADY and TVALID are high in the same cycle.
- TVALID once asserted, may only be de-asserted after a transfer has completed (TREADY is sampled high). Transfers may not be retracted or aborted.

- Once TVALID is asserted, no other signals in the same channel (except TREADY) may change value until the transfer completes (the cycle after TREADY is asserted).
- TREADY may be asserted before, during or after the cycle in which TVALID is asserted.
- The assertion of TVALID may not be dependent on the value of TREADY. But the assertion of TREADY may be dependent on the value of TVALID.
- There must be no combinatorial paths between input and output signals on both master and slave interfaces:
  - ◆ Applied to AXI4-Stream IP, this means that the TREADY slave output cannot be combinatorially generated from the TVALID slave input. A slave that can immediately accept data qualified by TVALID, should pre-assert its TREADY signal until data is received. Alternatively TREADY can be registered and driven the cycle following TVALID assertion.
  - ◆ The default design convention is that a slave should drive TREADY independently or pre-assert TREADY to minimize latency.
  - ◆ Note that combinatorial paths between input and output signals are permitted across separate AXI4-Stream channels. It is however a recommendation that multiple channels belonging to the same interface (related group of channels that operate together) should not have any combinatorial paths between input and output signals.
- For any given channel, all signals propagate from the source (typically master) to the destination (typically slave) except for TREADY. Any other information-carrying or control signals that need to propagate in the opposite direction must either be part of a separate channel (“back-channel” with separate TREADY/TVALID handshake) or be an out-of-band signal (no handshake). TREADY should not be used as a mechanism to transfer opposite direction information from a slave to a master.
- AXI4-Stream allows TREADY to be omitted which defaults its value to 1. This may limit interoperability with IP that generates TREADY. It is possible to connect an AXI4-Stream master with only forward flow control (TVALID only)

## AXI-Stream Blocks in System Generator

System Generator blocks that present an AXI4-Stream interface can be found in the Xilinx Blockset Library entitled AXI4. Blocks in this library are drawn slightly differently from regular (non AXI4-Stream) blocks.

### Port Groupings

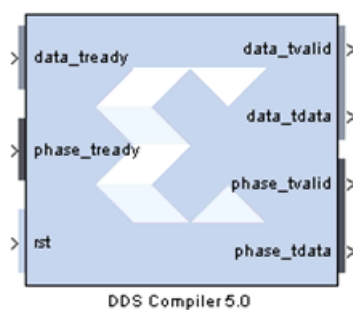

Blocks that proffer AXI4-Stream interfaces have AXI4-Stream channels grouped together and color coded. For example, on the DDS Compiler 5.0 block shown above, the top-most input port **data\_tready** and the top two output ports, **data\_tvalid** and **data\_tdata** belong in the same AXI4-Stream channel. As does **phase\_tready**, **phase\_tvalid** and **phase\_tdata**.

Signals that are not part of any AXI4-Stream channels are given the same background color as the block; **rst** is an example.

## Port Name Shortening

In the example shown below, the AXI4-Stream signal names have been shortened to improve readability on the block. Name shortening is purely cosmetic and when netlisting occurs, the full AXI4-Stream name is used. Name shortening is turned on by default; you can uncheck the **Display shortened port names** option in the block parameter dialog box to reveal the full name.

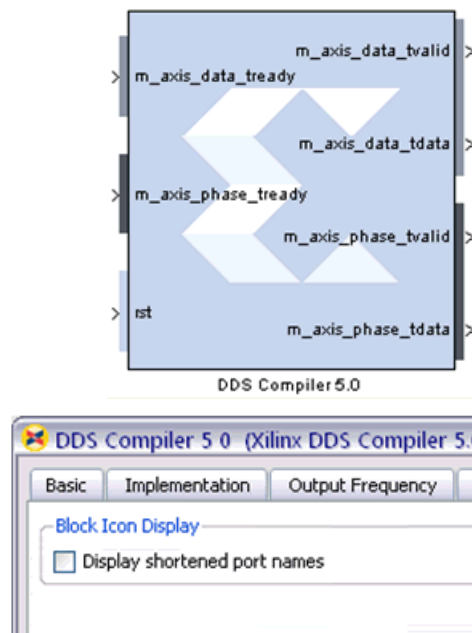

## Breaking Out Multi-Channel TDATA

In AXI4-Stream, TDATA can contain multiple channels of data. In System Generator, the individual channels for TDATA are broken out. So for example, the TDATA of port **dout** below contains both real and imaginary components.

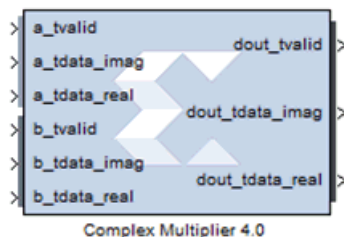

The breaking out of multi-channel TDATA does not add additional logic to the design and is done in System Generator as a convenience to the users. The data in each broken out TDATA port is also correctly byte-aligned.

# Hardware/Software Co-Design

---

The Chapter covers topics regarding developing software and hardware in System Generator.

<a href="#">Hardware/Software Co-Design in System Generator</a>	A collection of tutorial exercises that touch on designs with embedded processors.
<a href="#">Integrating a Processor with Custom Logic</a>	A collection of tutorial exercises that touch on designs with embedded processors
<a href="#">EDK Support</a>	Describes System Generator support for the Xilinx Embedded Development Kit.
<a href="#">Designing with Embedded Processors and Microcontrollers</a>	A collection of tutorial exercises that touch on designs with embedded processors.

## Hardware/Software Co-Design in System Generator

System Generator provides three ways for processors to be brought into a model; processors can be imported through a [Black Box](#) block, a [PicoBlaze Microcontroller](#) block and an [EDK Processor](#) block.

### Black Box Block

The Black Box approach provides the largest degree of flexibility, at the cost of design complexity. You can interface any processor HDL into a System Generator design in this manner. All ports and buses on the processor can be exposed to the System Generator diagram, and you are free to engineer the required connectivity between the processor and other System Generator blocks. You also have complete control over software compilation issues. Please refer to the topic [Importing HDL Modules](#) for more information.

### PicoBlaze Block

The PicoBlaze™ block provides the smallest degree of flexibility but is the least complex to use. The Xilinx PicoBlaze Microcontroller block implements an embedded 8-bit microcontroller using the PicoBlaze macro, and exposes a fixed interface to System Generator. Ordinarily, a single block ROM containing 1024 or fewer 8 bit words serves as the program store. You can program the PicoBlaze using the PicoBlaze Assembler language. This flow is documented in the topic [Designing PicoBlaze Microcontroller Applications](#).

### EDK Processor Block

The EDK Processor block provides an interface to MicroBlaze™ processors created using the Xilinx Platform Studio (XPS). The EDK Processor block allows System Generator Shared Memory blocks (i.e., "From/To Register"s, "From/To FIFOs", and "Shared Memory" blocks) to be associated with a processor through an automatically generated memory map interface. Once associated, that memory can be read or written in software running on the MicroBlaze processor. This flow is documented in the topic [Integrating a Processor with Custom Logic](#).

The EDK Processor block can import a MicroBlaze processor specified through an EDK project created using Xilinx Platform Studio and Base System Builder. Alternatively, a System Generator design with an EDK Processor block can also be exported into an EDK project.

The export process creates a PLB-based pcore, which can be added to any XPS project and communicate with the MicroBlaze or PowerPC® processor.

## Integrating a Processor with Custom Logic

Integrating a processor with a piece of user-defined logic is typically a fairly involved process. The communications between a processor and a custom piece of hardware often occurs over a shared bus. Additionally, the information conveyed frequently consists of different types of data; for example data for processing, data denoting the status of the hardware or data affecting the mode of operation. Organizing how this data is transferred between the processor and custom logic is a tedious and error prone process that would benefit from automation. Furthermore, connectivity is only half of the problem, writing software to communicate with custom logic can also be challenging.



The EDK Processor block provides a solution to both these problems through automation. The EDK Processor block encourages the interface between the processor and the custom logic to be specified via shared-memories. Shared-memories are used to provide storage locations that can be referenced by name. This allows a memory map and the associated software drivers to be generated.

Please refer to the [EDK Processor](#) block documentation regarding information on the use of the block. The topics that follow describe the automatic memory map creation, hardware generation in different compilation flows, and the use of the associated software drivers, and the two clock wiring schemes provided by the EDK Processor block.

<a href="#">Memory Map Creation</a>	Explains the memory map generated when shared memories are added to a processor.
<a href="#">Hardware Generation</a>	Documents the different hardware generation options in different compilation flows.
<a href="#">Hardware Co-Simulation</a>	Explains how to create a hardware co-simulation model for the EDK Processor block.
<a href="#">The Software Driver</a>	Documents how a software driver is created and how to writing software using the software driver to perform read/write operations to the memory-mapped interface.
<a href="#">Writing a Software Program</a>	Documents the process of writing software to control hardware created in System Generator.
<a href="#">Asynchronous Support</a>	Documents the capability in System Generator, in both import and export mode, to allow the processor and the System Generator design to run with different clocks.
<a href="#">Clock Wiring in the Hardware Co-Simulation Flow</a>	Documents the dual clock wiring and single clock wiring scheme offered by the EDK Processor block in the hardware co-simulation flow.
<a href="#">Troubleshooting</a>	Describes how to resolve issues such as how to update outdated netlists that are cached inside XPS.

## Memory Map Creation

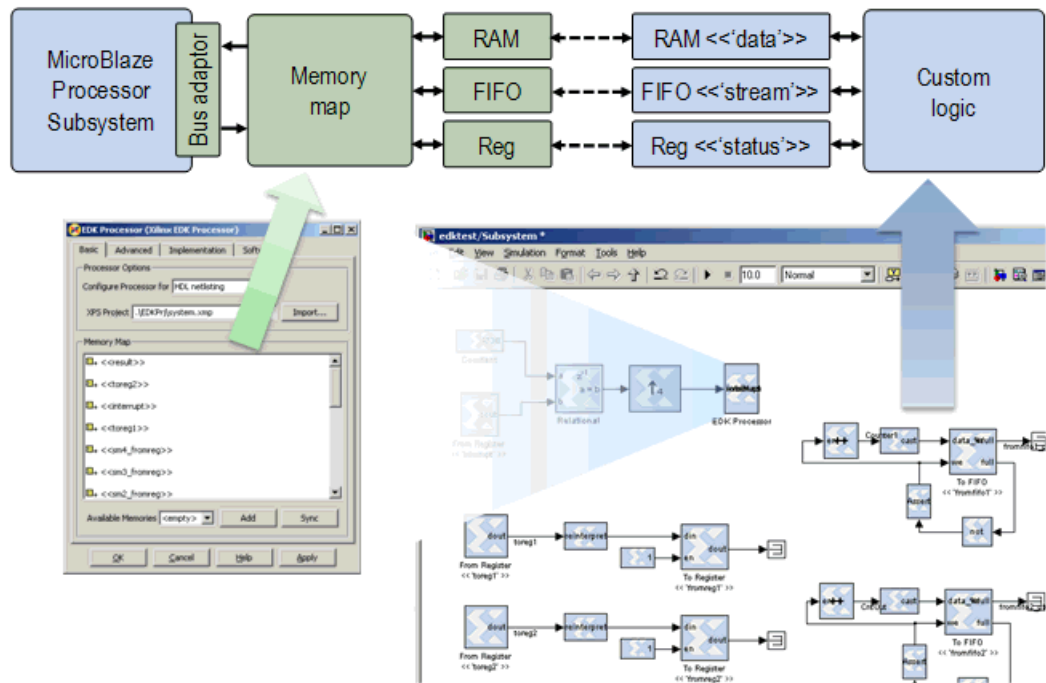

A System Generator model is shown on the bottom-right of the figure above. The System Generator model corresponds to custom logic that will be integrated with the MicroBlaze™ processor. In the construction of the model, shared-memories are used in locations where software access is required. For example, the status of the hardware might be kept in a register. To make that status information visible in the processor, the register is replaced by a named shared-register. Naming the shared-register "status" gives the name of the memory context that will be useful later on during software development.

The block GUI of the EDK Processor block allows these shared-memories to be added to the memory map of the processor (bottom-left of the figure). The block diagram at the top of the figure above shows the flow of data. When a shared memory is added to the memory map of the processor, the EDK Processor block creates the corresponding matching shared memory. This shared memory is attached to the memory map that is generated for that EDK Processor block. Next, a bus adaptor is used to connect that memory map to the MicroBlaze processor.

**Note:** The EDK Processor block does not support Shared Memory blocks with spaces in their names.

When hardware is generated, each shared memory pair is implemented with a single physical memory. The implementation for each class of shared memory is documented in the topic [Shared Memory Support](#), found under the topic [Using Hardware Co-Simulation](#).

## Hardware Generation

The EDK Processor block supports two modes of operation: EDK pcore generation and HDL netlisting. The different modes of operation are illustrated below and can be chosen from a list-box in the EDK Processor block's GUI.

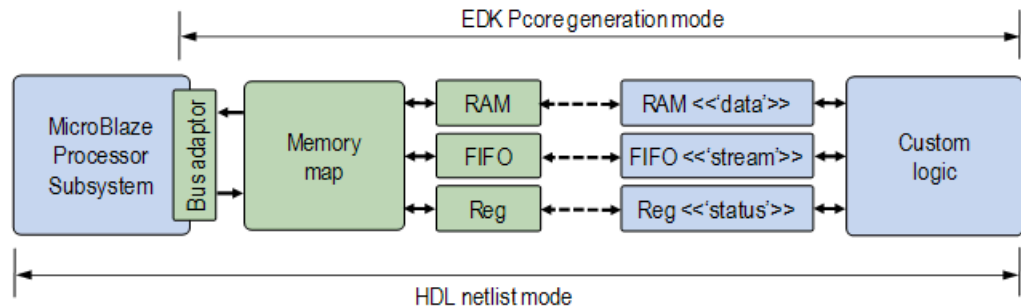

### EDK pcore Generation Mode

The Xilinx Embedded Development Kit (EDK) allows peripherals to be attached to processors created within the EDK. These peripherals can be packaged as pcors. Each pcore contains a collection of files describing the peripheral's hardware description, software drivers, bus connectivity and documentation.

When set in EDK-pcore-generation mode and used with the [EDK Export Tool](#) (selected via the System Generator token), System Generator is able to create a pcore from the given System Generator model. The figure above shows the part of the model that is created as a pcore. When set in this mode, the assumption is that the MicroBlaze™ processor added to the model is just a place-holder. Its actual implementation will be filled in by the EDK when the peripheral is finally added into an EDK project. As such, the pcore that is created consists of the custom logic, the generated memory map and virtual connections to the custom logic, and the bus adaptor.

### HDL Netlist Mode

An EDK processor can also be brought into a System Generator model when HDL netlisting mode is selected. The EDK Processor block can be set to HDL netlisting mode only when an EDK project is supplied to the block. When in HDL netlisting mode, the processor described in the EDK project will be imported into System Generator as a black box. The supplied EDK project is also augmented with the bus interfaces necessary to connect the System Generator memory map to the processor. During netlisting, the MicroBlaze™ processor and the generated memory-map hardware are both netlisted into hardware.

## Hardware Co-Simulation

Currently the EDK Processor block provides hardware-based simulation through hardware co-simulation. The creation of a Hardware Co-Simulation block follows the standard co-simulation flow described in the topic [Using Hardware Co-Simulation](#). The only difference is how top-level ports of the imported XPS project are treated.

When an XPS project is imported into System Generator, the import wizard assumes that all the ports are well constrained and applies that given constraint on the ports during the creation of the Hardware Co-Simulation block. That is to say, if the top-level entity of the XPS system contains ports that connect to pads on the FPGA, when compiling a Hardware

Co-Simulation block, these ports will still connect to the pads on the FPGA and will not appear as ports on the Hardware Co-Simulation block. Similarly, the bitstream flow constraints specified on top-level ports in the imported XPS system will be honored.

Should there be top-level ports that do not connect to pads, or are not constrained, these ports can be made visible in System Generator by exposing the ports using the Processor Port Interface table in the Advanced tab of the EDK Processor block. See the topic [Exposing Processor Ports to System Generator](#) for details.

You may use the EDK's XPS tool to write and compile your software. However before simulation can begin, the **Compile and update bitstream** button in the co-simulation block's **Software** tab must be used to put the compiled C-code into the bitstream.

When used in conjunction with a hardware-board supported by network-based hardware co-simulation, it is possible to free up the JTAG port on the FPGA and use that for software debug with XMD.

## The Software Driver

For both the EDK pcore generation mode and the HDL netlist mode, the EDK Processor block automatically generates a custom software driver, which can be used to drive the memory map which is automatically generated by the block.

### Location of the Software Driver

In the EDK pcore generation mode, the software driver is located at pathname `<pcores>/<sysgen_pcore_dir>/src.<sysgen_pcore_dir>` which is the directory where System Generator places the exported pcore. Normally, this is under the netlist directory specified by the System Generator token.

In the HDL netlist mode, when the XPS project is imported into System Generator, the software driver is placed at `<xps_project_dir>/pcores/sg_plbiface_v1_00_a/src`, where `<xps_project_dir>` is the location of the imported XPS project. After going through the HDL netlist, NGC netlist, Bitstream, or other hardware co-simulation compilation flows as provided by the System Generator token, the software driver and the associated API documentation are placed under the directory `<netlist_dir>/SDK_Export/sysgen_repos/drivers/sg_plbiface_v1_00_a/src` along with other SDK export files. By doing so, the generated software driver can be used in the Xilinx SDK (Software Development Kit).

### Launching Xilinx SDK from System Generator

In the HDL netlist mode, the EDK Processor automatically invokes the **Export to SDK** utility provided by XPS (Xilinx Platform Studio) to export the imported XPS project to `<netlist_dir>/SDK_Export`. For the Bitstream compilation flow, this directory also contains the bit file and the back-annotation BMM file generated from the compilation flow. Thus, for the Bitstream compilation flow, the `SDK_Export` directory is the only directory required to be handed off to a software developer for software development.

As shown in the following figure, you can click on the **Launch Xilinx SDK** button on the Software tab of a Hardware Co-Simulation block GUI to launch the Xilinx SDK.

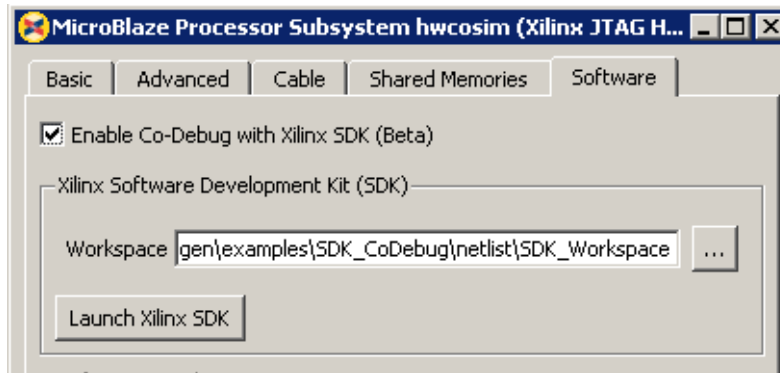

When Xilinx SDK is launched from System Generator, the following items are automatically set up by System Generator.

1. The workspace is set to the one as specified on the above Hardware Co-Simulation block GUI.
2. A Xilinx Hardware Platform Specification is automatically created and points to `<netlist_dir>/SDK_Export/hw/<edk_project_name>.xml`. This XML file is generated by XPS through the **Export to SDK** utility. It contains information from the hardware specification MHS file and software specification MSS file in the original XPS project.
3. System Generator automatically adds `<netlist_dir>/SDK_Export/sysgen_repos` to local software repositories. You can verify this by going to **Xilinx Tools > Repositories > Local Repositories** as shown in the following figure. By doing so, Xilinx SDK can locate the software driver generated by System Generator.

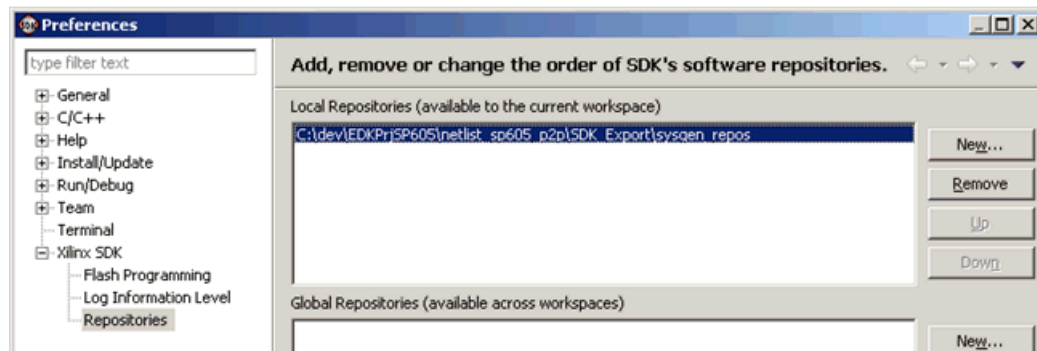

**Note:** If you launch Xilinx SDK standalone, rather than through System Generator as mentioned above, you need to specify the Workspace directory and manually add the folder `<netlist_dir>/SDK_Export/sysgen_repos` to the local repositories.

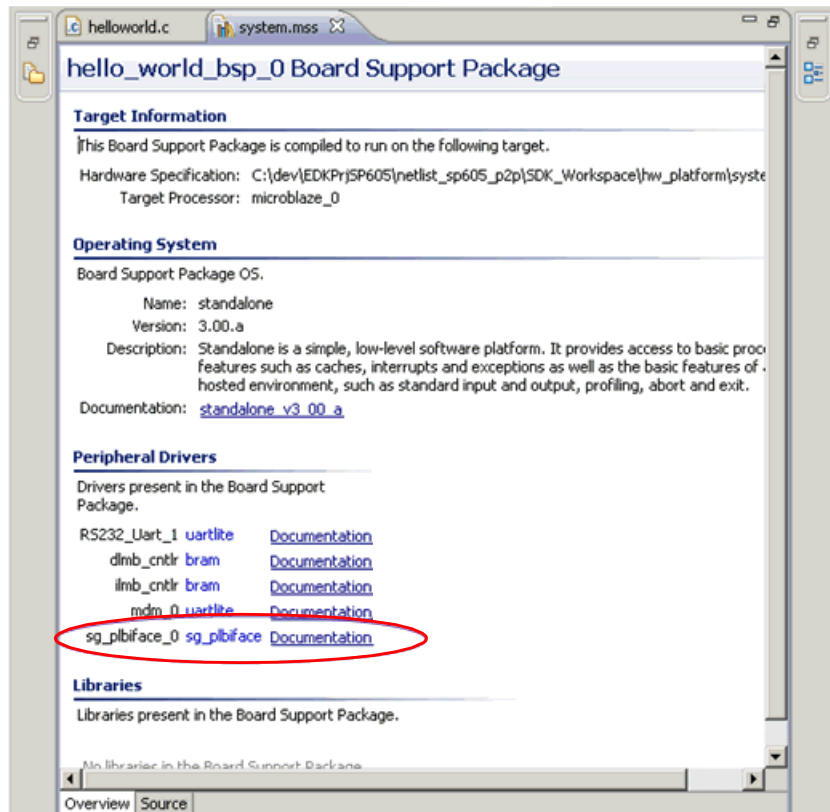

## API Documentation

There is API documentation associated with the software driver, which you can find by clicking the Documentation link shown in the above the figure.

In order to utilize these functions, the following two header files need to be included in your C code.

```
#include "xparameters.h"
#include "sg_plbiface.h"
```

The hardware settings of the shared memories inside the System Generator pcore can be found in the header file `xparameters.h`. For example, absolute memory-mapped addresses, data bit widths (`n_bits`) and binary point positions (`bin_pt`), depths of the "To FIFO" shared memories on the processor memory map can be found in this header file. The header file `sg_plbiface.h` defines the basic data types and software driver functions for accessing the shared memories.

There is a *Shared Memory Settings* session in the API documentation, which lists the settings of the available shared memories contained by the System Generator peripheral as shown in the following figure.

Shared Memory Settings			
Shared Memory Name	Memory type	Access Data Type	Native Precision*
dout	From FIFO	xc_from_fifo_t	UFix_32_0
din	To FIFO	xc_to_fifo_t	UFix_32_0

## Writing a Software Program

You should follow the Xilinx SDK flow to create a software application project and write software to drive the System Generator peripheral. In the HDL netlist mode, you can choose a sample application to customize for the System Generator peripheral as shown in the figure below.

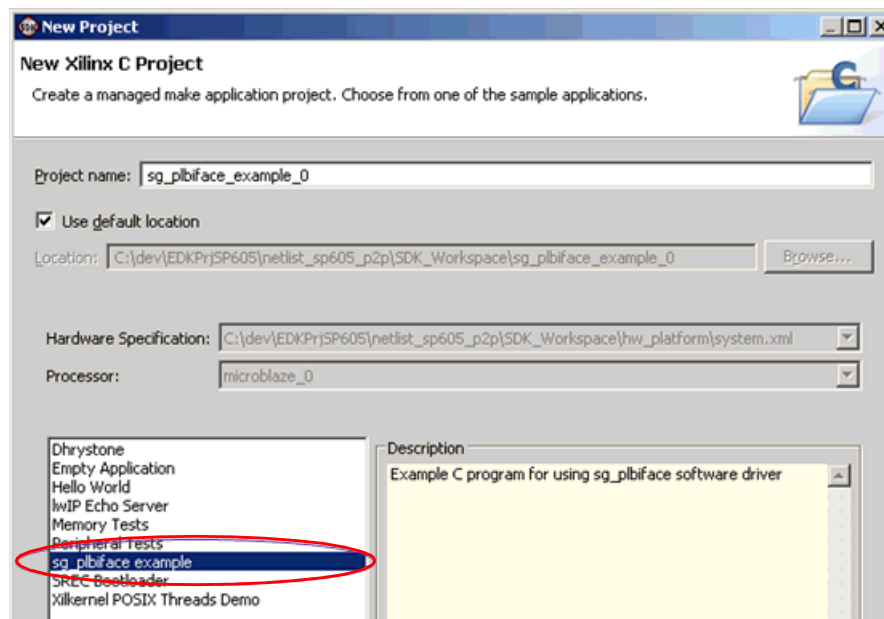

In the API documentation, a number of example code snippets are provided to perform read/write operations. These code snippets are detailed in the following text.

## Accessing "From Register" and "To Register" shared memories

### Single-Word Writes

The following code snippet writes a value to the "To Register" shared memory named "toreg".

```
uint32_t value;
xc_iface_t *iface;
xc_to_reg_t *toreg;

// initialize the software driver, assuming the Pcore device ID is 0
xc_create(&iface, &SG_PLBIFACE_ConfigTable[0]);
```

```
// obtain the memory location for storing the settings of shared memory
"t"
xc_get_shmem(iface, "toreg", &toreg);
// write value to the "din" port of shared memory "toreg"
xc_write(iface, toreg->din, (const unsigned) value);
```

### Single-Word Reads

The following code snippet reads data stored in the "From Register" shared memory named "fromreg" into "value".

```
uint32_t value;
xc_iface_t *iface;
xc_from_reg_t *fromreg;
// initialize the software driver, assuming the Pcore device ID is 0
xc_create(&iface, &SG_PLBIFACE_ConfigTable[0]);

// obtain the memory location for storing the settings of shared memory
"fromreg"
xc_get_shmem(iface, "fromreg", (void **) &fromreg);
// read data from the "dout" port of shared memory "fromreg" and store
at value
xc_read(iface, fromreg->dout, &value);
```

## Accessing "From FIFO" and "To FIFO" shared memories

### Single-Word Writes

The following code snippet writes value to the "To FIFO" shared memory named "tofifo".

```
uint32_t full;
uint32_t value;
xc_iface_t *iface;
xc_to_fifo_t *tofifo;
// initialize the software driver, assuming the Pcore device ID is 0
xc_create(&iface, &SG_PLBIFACE_ConfigTable[0]);

// obtain the memory location for storing the settings of shared memory
"t"
xc_get_shmem(iface, "tofifo", (void **) &tofifo);
// check the "full" port of shared memory "tofifo"
do {
    xc_read(iface, tofifo->full, &full);
} while (full == 1);
// write value to the "din" port of shared memory "tofifo"
value = 100;
xc_write(iface, tofifo->din, value);
```



## Single-Word Reads

The following code snippet reads data stored in the "From Register" shared memory named "fromreg" into "value".

```
uint32_t empty;
uint32_t value;
xc_iface_t *iface;
xc_from_fifo_t *fromfifo;
// initialize the software driver, assuming the Pcore device ID is 0
xc_create(&iface, &SG_PLBIFACE_ConfigTable[0]);

// obtain the memory location for storing the settings of shared memory
"fromfifo"
xc_get_shmem(iface, "fromreg", (void **) &fromfifo);
// check the "empty" port of shared memory "fromfifo"
do {
    xc_read(iface, fromfifo->empty, 0);
} while (empty == 1);
// read data from the "dout" port of shared memory "fromfifo" and store
at value
xc_read(iface, fromfifo->dout, &value);
```

## Accessing "Shared Memory" Shared Memories

### Single-Word Writes

The following code snippet writes "value" to the shared memory named "shram1".

```
uint32_t value;
xc_iface_t *iface;
xc_shram_t *shram;
// initialize the software driver, assuming the Pcore device ID is 0
xc_create(&iface, &SG_PLBIFACE_ConfigTable[0]);

// obtain the memory location for storing the settings of shared memory
"shram1"
xc_get_shmem(iface, "shram1", (void **) &shram);
// write value to the shared memory "shram1"
xc_write(iface, xc_get_addr(shram->addr, 2), (const unsigned) value);
```

### Single-Word Reads

The following code snippet reads data stored in the shared memory named "shram2" into "value".

```
uint32_t value;
xc_iface_t *iface;
xc_shram_t *shram;
// initialize the software driver, assuming the Pcore device ID is 0
xc_create(&iface, &SG_PLBIFACE_ConfigTable[0]);

// obtain the memory location for storing the settings of shared memory
"fromfifo"
xc_get_shmem(iface, "shram2", (void **) &shram);
// read data from the shared memory "shram2" and store at value
xc_read(iface, xc_get_addr(shram->addr, 2), &value);
```

## Asynchronous Support

Asynchronous support for processors allow for the processor and the accelerator hardware hanging off the processor to be clocked with different clocks. This allows the hardware accelerator to run at the fastest possible clock rate, or at a clock rate that is necessary for its correct functioning, for example when it is required to interface with an external peripheral.

This feature is enabled when the **Dual Clock** check box is selected in the EDK Processor block GUI's Implementation tab. The figure below shows how clocks will be connected for the import and export flow; in the export flow, the MicroBlaze™(MB) block is not present. Basically, the custom logic design in System Generator is driven with the clk clock and the processor system is driven with the xps\_clk clock. The clock source that drives the PLB bus in the MicroBlaze processor system is extracted to drive the bus adaptor, the memory map, and halves of the shared memories. Shared memories straddle between these two domains (e.g. the clk domain and the plb\_clk domain) and are driven by both these clocks. In the import flow where an XPS project is imported into System Generator, the PLB bus on the processor must be driven with the same clock as the xps\_clk signal.

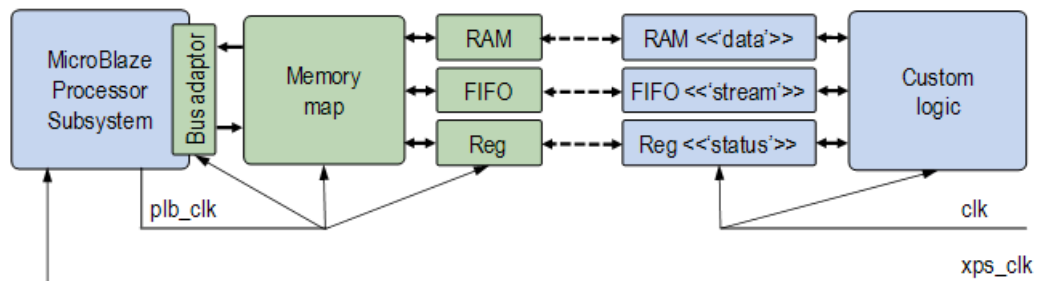

When **Dual Clock** is enabled and a design is netlisted for hardware co-simulation, a slightly different clock wiring topology is used. This is shown in the figure below. The clock source from the board is bifurcated with one branch going into the Hardware Co-simulation module before being connected to the clk clock (depicted in the figure above). The other branch is routed through a clock buffer and connected to the xps\_clk clock signal.

This topology allows for the custom logic designed in System Generator to be single-stepped, while allowing the MicroBlaze processor to continue in free-running mode. This allows for clock-sensitive peripherals (such as the RS232 UARTS) to work when the Hardware Co-Simulation token is set to single-step.

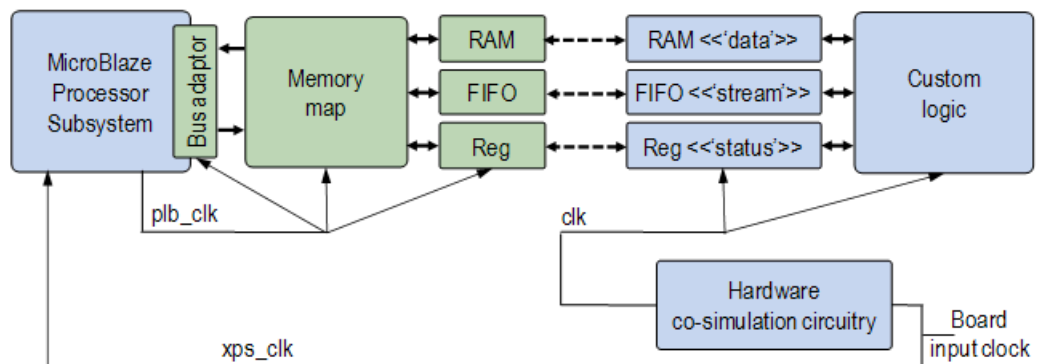

In hardware co-simulation, the processor subsystem is driven by the board clock directly. This means that the processor subsystem must be able to meet the requirements set by this clock. In hardware co-simulation, it is possible for users to select different ratios of clock frequencies based on the input board frequency. Note that this hardware co-simulation clock is generated in the hardware co-simulation module and is not available to the processor subsystem.

For example, if the input board frequency is 125 MHz, and the hardware co-simulation frequency is set to 33 MHz, only the custom logic portion of the design will be constrained to 33 MHz, the MicroBlaze processor must still run at 125 MHz. If the MicroBlaze processor cannot meet timing at this speed, you need to instantiate a clock generator peripheral in your XPS project and slow down the clock in that way.

## Clock Wiring in the Hardware Co-Simulation Flow

When a Xilinx Platform Studio (XPS) project is imported into System Generator using the EDK Processor block, you can generate a Hardware Co-Simulation block for the imported XPS project. The Hardware Co-Simulation block allows you to run the XPS system on the hardware while simulating the System Generator design in Simulink on the host PC.

In a typical hardware co-simulation session, a portion of the System Generator design runs on hardware, while the rest of the design is simulated in software. The design portion running in hardware is driven with a clock generated by a clock control module. This clock control module is a piece of hardware automatically inserted by System Generator hardware co-simulation to ensure that the hardware and the Simulink simulation are synchronized. The hardware co-simulation flow allows you to select the clock frequency used to drive the hardware. For example, in the hardware co-simulation settings dialog box for the ML506 board shown below, a 100 MHz clock frequency is selected. The Design Under Test (DUT) running on hardware is then driven by a 100 MHz clock output from the hardware co-simulation clock control module.

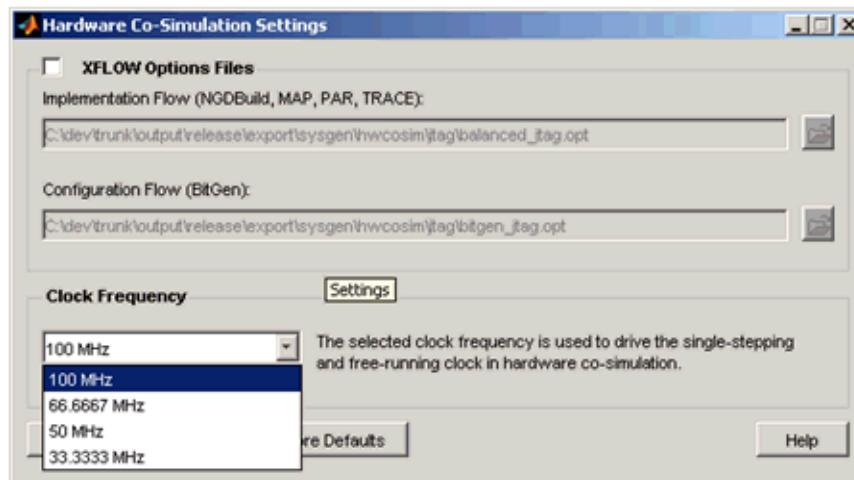

When participating in hardware co-simulation, the EDK Processor block provides two clocking schemes to suit different simulation and runtime requirements: *dual*-clock wiring and *single*-clock wiring. In dual-clock wiring, the EDK Processor and the System Generator design are driven by two asynchronous clocks; in single-clock wiring, the EDK Processor and the rest of the System Generator design are driven by the same clock.

As a rule of thumb, if you want the processor to free-run at the board rate, you should choose the dual-clock wiring scheme. In case you want to single-step the processor for debug or profiling purposes, you should choose the single-clock wiring scheme.

Starting with Release 12.1, the dual-clock wiring scheme is turned on by default. You can change the wiring scheme to single-clock wiring through the Implementation tab on the EDK Processor block GUI.

## Dual Clock Wiring Scheme

There are three key advantages of the dual-clock wiring scheme. The first advantage is to allow the imported XPS project (processor) to run at full speed. This allows peripherals interfacing with external I/Os such as UART and memory controller to function correctly during simulation.

The second advantage is to speed up the simulation time by having an asynchronous communication interface between the XPS project with the DUT. In fact, the DUT and the imported XPS project run asynchronously. The DUT is controlled by the clock control module automatically added by System Generator hardware co-simulation. This clock control module ensures that the DUT is synchronized with the Simulink software simulation during single-stepped hardware co-simulation. Allowing the imported XPS project and the processor inside it to run asynchronously from the DUT eliminates the need to simulate though thousands of lines of boot-loading code before meaningful data shows up in Simulink.

The dual-clock wiring scheme is shown in the figure below. The main difference compared with the single-clock wiring scheme is that the board input clock directly drives the hardware co-simulation module and the imported XPS project.

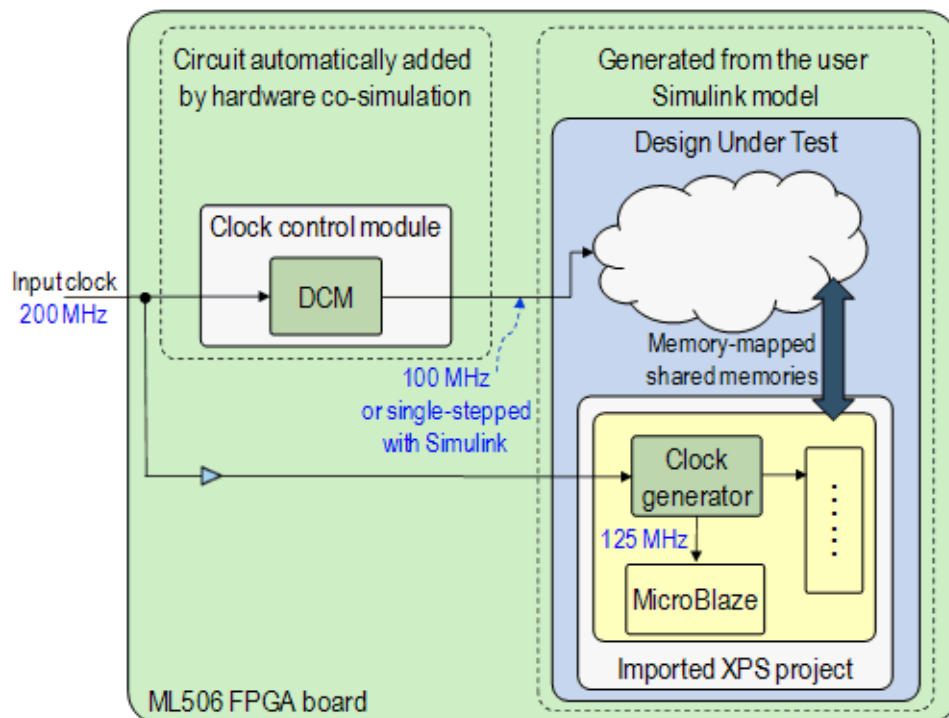

The third advantage is that designs compiled with the dual-clock wiring scheme tend to meet timing more easily compared with the single-clock wiring scheme. With the dual-clock wiring scheme, the DCM in the hardware co-simulation clock control module and the clock generator in the imported XPS project are not cascaded (as is the case when single-clock wiring is used). This greatly improves the chances of meeting timing when generating the Hardware Co-Simulation block with the imported XPS project.

### Limitations for Boards with Multiple-Input Clocks

In the dual-clock wiring scheme, both the hardware co-simulation clock control module and the imported XPS project are driven by the board input clock specified by the hardware co-simulation compilation target. For FPGA boards with multiple clock sources, it is possible that the imported XPS project uses a different board input clock than the System Generator hardware co-simulation compilation target.

An example is the ML506 FPGA board. The ML506 FPGA board has two input clock sources, one crystal 100 MHz input clock and one LVDS 200 MHz input clock. The XPS project generated by Base System Builder uses the 100 MHz input clock, while the System Generator ML506 hardware co-simulation compilation target uses the LVDS 200 MHz input clock.

The following procedure uses the ML506 board to illustrate how to change the clock sources in an XPS project in order to match the input clock source used by System Generator hardware co-simulation.

1. Find out the frequency of the board input clock used by the System Generator hardware co-simulation target. For the JTAG ML506 hardware co-simulation compilation target, you can look at the file  
`<sysgen>/plugins/compilation/Hardware Co-Simulation/ML506/JTAG/ML506_JTAG.ucf`
2. Verify that the board input clock frequency is 200 MHz. Another way to find out the board input clock source is to run the hardware co-simulation compilation target once and look at the file `<netlist_dir>/jtagcosim_top.ucf`. In the following snippet of the file `ML506_JTAG.ucf`, you can see that the System Generator hardware co-simulation uses a 200 MHz LVDS board input clock source.

```
NET "sys_clk_p" LOC = "L19";
NET "sys_clk_n" LOC = "K19";
NET "sys_clk_p" TNM_NET = "hwcosim_sys_clk";
NET "sys_clk_n" TNM_NET = "hwcosim_sys_clk";
TIMESPEC "TS_hwcosim_sys_clk" = PERIOD "hwcosim_sys_clk" 200 MHz HIGH
50%;
```

3. In the `system.mhs` file found in the XPS project, change the input clock frequency from 100 MHz to 200 MHz, which is the frequency of the clock source used by the System Generator hardware co-simulation compilation target.

```
PORT fpga_0_clk_1_sys_clk_pin = dcm_clk_s, DIR = I, SIGIS = CLK,
CLK_FREQ = 20000000
```

- Change the input clock frequency of the clock generator in the imported XPS project.

```

BEGIN clock_generator
  PARAMETER INSTANCE = clock_generator_0
  PARAMETER C_CLKIN_FREQ = 200000000
  PARAMETER C_CLKOUT0_FREQ = 125000000
  PARAMETER C_CLKOUT0_PHASE = 0
  PARAMETER C_CLKOUT0_GROUP = NONE
  PARAMETER C_CLKOUT0_BUF = TRUE
  PARAMETER C_EXT_RESET_HIGH = 0
  PARAMETER HW_VER = 4.00.a
  PORT CLKIN = dcm_clk_s
  PORT CLKOUT0 = clk_125_0000MHz
  PORT RST = sys_rst_s
  PORT LOCKED = Dcm_all_locked
END

```

- After this, you can import the modified XPS project through the EDK Processor block and generate a Hardware Co-Simulation block for this project.

## Single Clock Wiring Scheme

The System Generator hardware co-simulation module can use the DCM (Digital Clock Manager), the MMCM (Mix-Mode Clock Manager), or the PLL (Phase Lock Loop) to convert the board input clock to the clock frequency requested by you. The clock generated by hardware co-simulation is used to drive all blocks in the DUT.

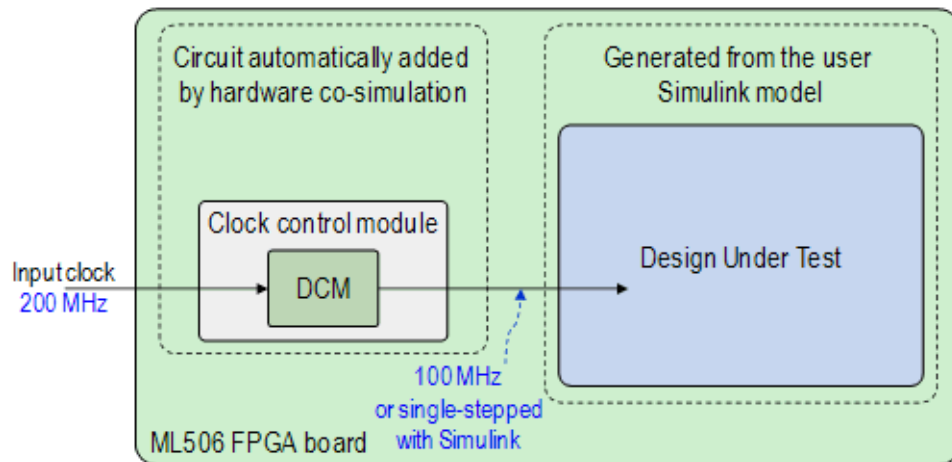

When a System Generator model contains an XPS project imported through the EDK Processor block in single clock mode, the XPS project is driven by the clock generated by the Hardware Co-Simulation module. This allows the processor to be simulated in lock-step with the rest of the DUT and the Simulink simulation. This kind of simulation can be very helpful when you are debugging transactions over a custom bus or when you are profiling code.

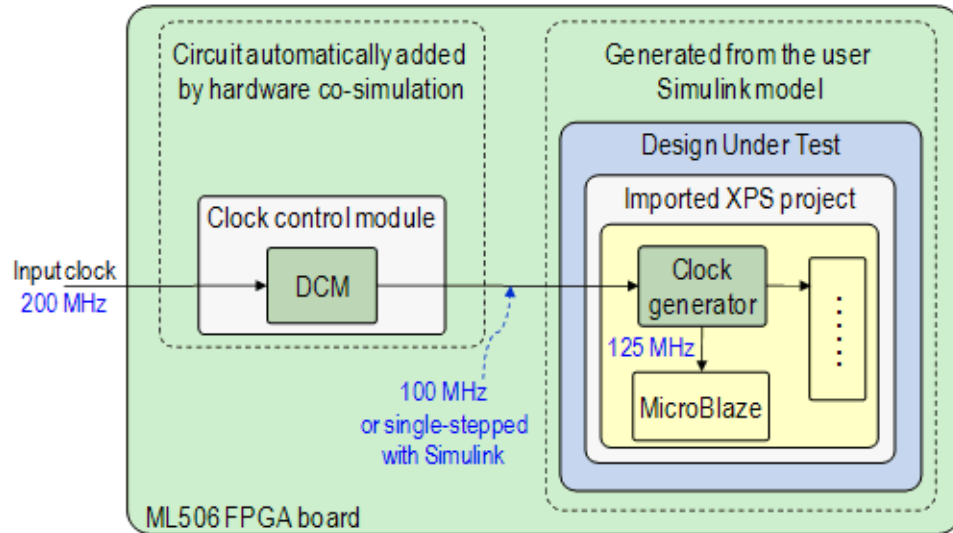

### Limitations with the XPS Clock Generator

An XPS project created using BSB (Base System Builder) usually includes a clock generator, which is used to generate clock signals with requested frequencies to drive the MicroBlaze processor and other peripherals such as DDR3 external memory and Ethernet MAC. Similar to the hardware co-simulation module, the clock generator generates the requested clock frequencies using DCM/MMCM/PLL.

In the single-clock wiring scheme depicted in the previous figure, the DCM inside the hardware co-simulation clock control module and the clock generator from the imported XPS project are cascaded. For some FPGA boards such as ML506 and SP601, cascading DCM/PLLs prevents the design from achieving timing closure.

Additionally, in single-step hardware co-simulation, the output clock from the hardware co-simulation module is synchronized with the Simulink simulation. The XPS clock generator simply stops working in single-stepped hardware co-simulation.

### One Solution to the Single-Clock Wiring Limitations

One solution to the limitation described above is to take out the clock generator in the XPS project and re-import it into System Generator. The following procedure illustrates how to take out the clock generator using a ML506-based project generated using BSB. While you can do this through the XPS GUI, this procedure shows you how to modify the MHS (Microprocessor Hardware Specification) file and MSS (Microprocessor Software Specification) file directly to remove clock generator.

1. The original `system.mhs` file created using BSB is shown below. Observe that the input board clock `fpga_0_clk_1_sys_clk_pin` is connected to the `CLKIN` pin of the clock generator instance. The output clock pin `CLKOUT0` is then used to drive the processor and the other hardware peripherals.



```
PORT fpga_0_clk_1_sys_clk_pin = dcm_clk_s, DIR = I, SIGIS = CLK,
CLK_FREQ = 100000000
```

```
BEGIN clock_generator
PARAMETER INSTANCE = clock_generator_0
PARAMETER C_CLKIN_FREQ = 100000000
PARAMETER C_CLKOUT0_FREQ = 125000000
PARAMETER C_CLKOUT0_PHASE = 0
PARAMETER C_CLKOUT0_GROUP = NONE
PARAMETER C_CLKOUT0_BUF = TRUE
PARAMETER C_EXT_RESET_HIGH = 0
PARAMETER HW_VER = 4.00.a
PORT CLKIN = dcm_clk_s # input clock
PORT CLKOUT0 = clk_125_000MHz # output clock
PORT RST = sys_rst_s
PORT LOCKED = Dcm_all_locked
END
```

- Next, you should simply comment out the clock generator. The output clock is directly attached to the board input clock. The modified `system.mhs` file is like the following:

```
PORT fpga_0_clk_1_sys_clk_pin = clk_125_000MHz, DIR = I, SIGIS = CLK,
CLK_FREQ = 100000000
# BEGIN clock_generator
# PARAMETER INSTANCE = clock_generator_0
# PARAMETER C_CLKIN_FREQ = 100000000
# PARAMETER C_CLKOUT0_FREQ = 125000000
# PARAMETER C_CLKOUT0_PHASE = 0
# PARAMETER C_CLKOUT0_GROUP = NONE
# PARAMETER C_CLKOUT0_BUF = TRUE
# PARAMETER C_EXT_RESET_HIGH = 0
# PARAMETER HW_VER = 4.00.a
# PORT CLKIN = dcm_clk_s # input clock
# PORT CLKOUT0 = clk_125_000MHz # output clock
# PORT RST = sys_rst_s
# PORT LOCKED = Dcm_all_locked
# END
```

- The `Dcm_all_locked` pin on the clock generator is used to indicate whether the output clock signal is locked with the input clock signal. Replace the input pins driven by this signal with `net_vcc`. These kind of changes can be tricky in some design scenarios. So far, no abnormality has been observed for the hardware peripherals generated from BSB.

```
BEGIN proc_sys_reset
PARAMETER INSTANCE = proc_sys_reset_0
PARAMETER C_EXT_RESET_HIGH = 0
PARAMETER HW_VER = 2.00.a
PORT Slowest_sync_clk = clk_125_000MHz
PORT Ext_Reset_In = sys_rst_s
PORT MB_Debug_Sys_Rst = Debug_SYS_Rst
PORT Dcm_locked = net_vcc # changed from Dcm_all_locked
PORT MB_Reset = mb_reset
PORT Bus_Struct_Reset = sys_bus_reset
PORT Peripheral_Reset = sys_periph_reset
END
```



4. Comment out the software driver for the clock generator in the `system.mss` file
 

```
# BEGIN DRIVER
# PARAMETER DRIVER_NAME = generic
# PARAMETER DRIVER_VER = 1.00.a
# PARAMETER HW_INSTANCE = clock_generator_0
# END
```
5. After the modification, the clock generator is safely removed from the XPS project. You can import this modified XPS project into System Generator through the single-clock wiring scheme.

## Caveats with Peripherals like UART and MDM

Peripherals like UART and MDM (microprocessor debugger module) do not work in the single-stepped hardware co-simulation mode.

The UART peripheral needs to be driven by a specific input clock source in order to communicate properly through the serial ports. If you choose a hardware co-simulation frequency on the hardware co-simulation dialog box which is different from the clock frequency with the original XPS project, you will see invalid output on the serial port console.

For MDM, its connection with `gdb` will time out if its input clock frequency is too slow. In this case, the debug session in SDK (Software Development Kit) or XMD (Xilinx Microprocessor Debugger) will run into errors such as “Unable to stop MicroBlaze processor.”

## Troubleshooting

### Limitations on the Imported XPS Project

In theory, any XPS project can be imported into System Generator through the EDK Processor block. However, you may need to modify the XPS project in some situations to avoid resource conflicts and to allow the EDK Processor block to properly interpret the project.

- **Input clock port:** XPS uses `SIGIS = CLK` to tag an external port as a clock port. The EDK Processor block only recognizes a single input clock to implement the single clock and dual clock wiring described above. In this case, you need to remove the `SIGIS = CLK` tag on other clock ports. The following XPS project example has two input clock ports, `sys_clk_pin` and `fpga_0_PCIe_Diff_Clk_IBUF_DS`. In order to import this project into System Generator, you need to ensure that `SIGIS = CLK` is removed from the PCI input clock ports.
 

```
PORT sys_clk_pin = dcm_clk_s, DIR = I, SIGIS = CLK, CLK_FREQ = 100000000
PORT fpga_0_PCIe_Diff_Clk_IBUF_DS_P_pin = PCIe_Diff_Clk, DIR = I,
DIFFERENTIAL_POLARITY = P # need to remove SIGIS = CLK
PORT fpga_0_PCIe_Diff_Clk_IBUF_DS_N_pin = PCIe_Diff_Clk, DIR = I,
DIFFERENTIAL_POLARITY = N # need to remove SIGIS = CLK
```
- **Resource conflict:** You need to ensure that there is no resource conflict between the imported XPS project and the rest of the System Generator design. For example, if you use the Point-to-Point Ethernet-Based Hardware Co-Simulation flow and the target hardware board has only one Ethernet MAC component (e.g., the Xilinx ML506, SP601, and SP605 evaluation boards), the XPS project can contain peripherals that use the Ethernet MAC (e.g., `xps_ethernetlite`). You should consider changing to the JTAG-Based Hardware Co-Simulation flow in this case. Another example is when the target hardware board only has a single BSCAN module (e.g., the Spartan 3A DSP 1800

Starter board). You have to remove the JTAG-Based MDM (Microprocessor Debug Module) peripheral from the imported XPS project. Otherwise, you need to switch to the Point-to-Point Ethernet-Based Hardware Co-Simulation flow and use the Ethernet for downloading the bitstream.

- **Constraint handling:** The EDK Processor block automatically modifies the UCF (user constraint file) file from the imported XPS based on the compilation flow that is used. Upon importing an XPS project, a copy of the modified UCF file is placed under `<xps_project_dir>/data/sg_<xps_project_name>.ucf`. The snippet of a modified UCF file is shown below. Constraints that belong to certain external ports of the imported XPS are commented/uncommented depending on whether or not the port is exposed on the EDK Processor block. The input clock ports are commented out in the hardware co-simulation flow automatically.

```
# constraints for pin 'fpga_0_RS232_Uart_1_RX_pin' (not exposed)
Net fpga_0_RS232_Uart_1_RX_pin LOC = AG15 | IOSTANDARD=LVCMOS33;

# constraints for pin 'fpga_0_RS232_Uart_1_TX_pin' (not exposed)
Net fpga_0_RS232_Uart_1_TX_pin LOC = AG20 | IOSTANDARD=LVCMOS33;

# constraints for pin 'fpga_0_clk_1_sys_clk_pin' (exposed, clock port)
# Net fpga_0_clk_1_sys_clk_pin TNM_NET = sys_clk_pin;
# TIMESPEC TS_sys_clk_pin = PERIOD sys_clk_pin 100000 kHz;
# Net fpga_0_clk_1_sys_clk_pin LOC = AH15 | IOSTANDARD=LVCMOS33;
```

In case where you do not want the EDK Processor block to make automatic modifications, you can put the line `#### SYSGEN VERBATIM ###` in the original XPS project UCF file. All the lines after this commented line will be untouched. See the explanation found from the beginning of the modified UCF file, which is also shown in the code snippet below.

```
# This file is generated automatically by System Generator for DSP from
# the following file:
#
# C:\dev\trunk\test\edk\edkplbimport\EDKPrj\data\system.ucf
# Do NOT modify this file directly. Instead, change the above original
# file. Synchronize the processor memory map, or re-import the XPS
# project to apply the changes. # # In case that the automatic changes
# by System Generator for DSP are
# undesired, put the following comment in the above original file. All
# the contents after this comment will be copied verbatim.

# #### SYSGEN VERBATIM ###
```

## EDK Support

### Importing an EDK Processor

How to import an EDK project into System Generator using the EDK Import Wizard.

### Exposing Processor Ports to System Generator

How to route top-level ports in the EDK into System Generator.

### Exporting a pcore

How to export a System Generator design to the EDK as a pcore.

## Importing an EDK Processor

A processor created using the Xilinx Platform Studio (XPS) tool, found in the Xilinx EDK suite of tools, can be imported into a System Generator model using the EDK Import Wizard.

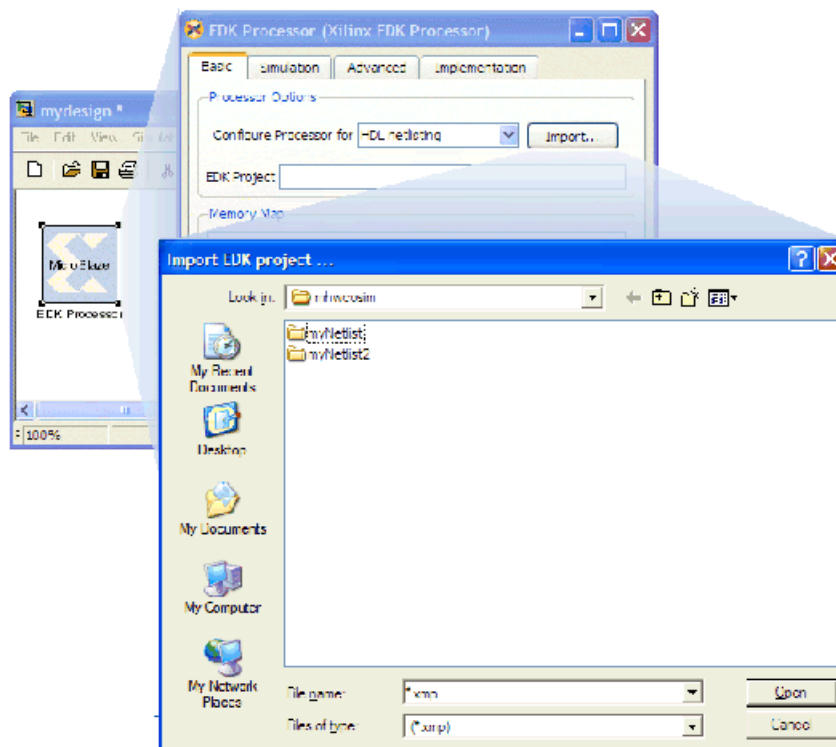

There are two ways to launch the EDK Import Wizard in the EDK Processor block: (1) press the **Import...** button, or (2) select **HDL netlisting** when the **EDK project** field is empty.

**Note:** When you import the EDK Project into System Generator, there are modifications made to the EDK project. These modifications are described in the following topic.

## EDK Import Wizard

When the Wizard starts up, it prompts you for an EDK project file (xmp file).

Clicking the **Import...** button starts the import process.

**Note:** The import process will alter your EDK project to work inside System Generator. If you wish to retain an unadulterated version, please make a copy before importing. System Generator automatically backs up the hardware platform specification (i.e., the MHS file) and the software platform specification (the MSS file) of the EDK project to files with the "bak" suffix.

When an EDK project is imported into System Generator, the EDK project is augmented with a PLB46 interface depending on the options made on the EDK Processor block. A pcore (xlsg\_plbiface) is also added to provide software drivers for the interface. The MHS and MSS files in the EDK project will be altered. Following that, the HDL files that describe the processor will be generated and linked to your System Generator project.

## Making Changes to Processor Hardware After an Import

After importing an EDK project, further changes to the hardware inside of the EDK will not be reflected inside of System Generator. In other words, the hardware makeup of the processor is now fixed. If changes to the processor hardware are to be made, the EDK project must be re-imported using the EDK Import Wizard.

It is recommended that you re-import an EDK project when it is changed. The EDK Processor block can detect the PLB interfaces and the related pcores that are automatically added by System Generator during a previous import, and will not include redundant hardware or software to the XPS project.

## Limitations

Currently the Wizard can only import single processor projects. Only the MicroBlaze processor is supported. Peripherals added to the processor cannot conflict with the resources used by other System Generator services. For instance, if network-based hardware co-simulation is used, the EDK project cannot make use of the peripherals using the Ethernet MAC.

## Exposing Processor Ports to System Generator

The preferred mechanism for getting data to and from the processor and System Generator is via shared-memories. It is however possible to expose ports on the top-level of the processor to System Generator.

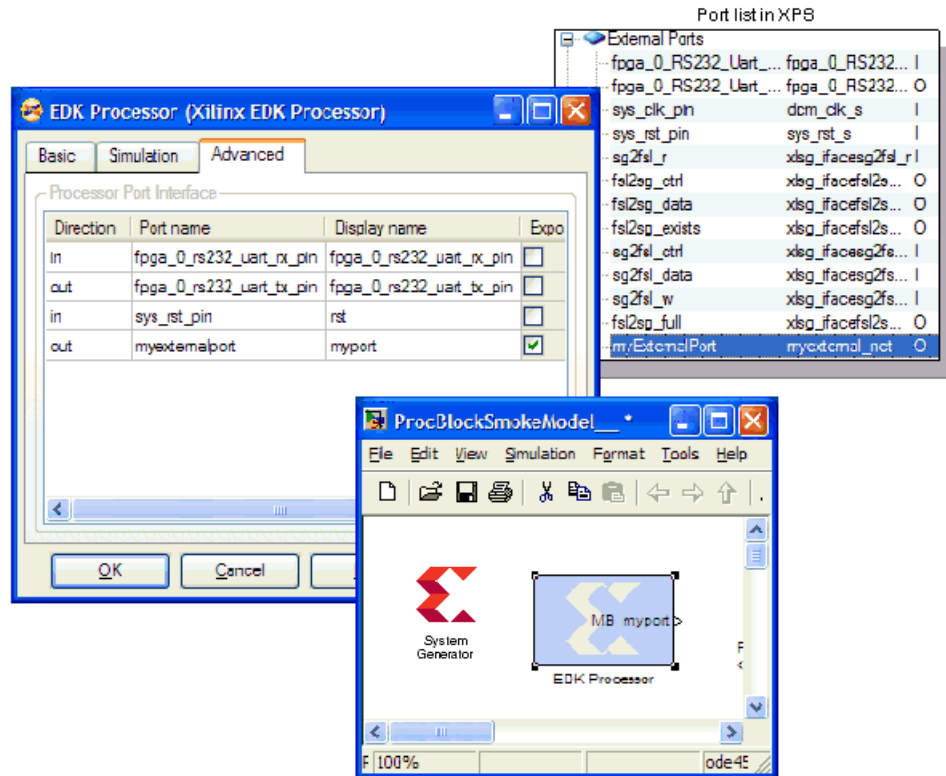

The top-right box in the figure above shows a snippet from an EDK project in XPS. The external port list has among other ports, a user-defined port called *myExternalPort*.

After importing the EDK project, open up the processor's block GUI in System Generator. Select the **Advanced** tab to reveal the processor port interface table.

The port list shows all the top-level ports available on the processor. This port list has been filtered to remove clock ports and also signals used by System Generator to implement the memory-map interface. In this example, the RS232 ports, *sys\_rst\_pin* and *myexternalport* are shown to be ports that can be exposed to the top-level of the System Generator block. Selecting the **expose** check box will cause the port to be exposed on the EDK Processor block. As shown in the figure above, the display name of the port can be changed, should the original name be too long.

This mechanism allows ports from the processor to be directly exposed to the System Generator design without going through the memory map generated by System Generator. You may choose to do this to expose the reset ports on the processor, or to expose interrupt ports directly to the System Generator diagram.

## Exporting a pcore

System Generator designs containing an EDK Processor block can be exported as an EDK pcore using the **EDK Export Tool** compilation target on the System Generator token.

Before exporting to the EDK as a pcore, the EDK Processor block must be configured for "EDK pcore generation". This can be done by opening the EDK Processor block GUI and selecting the relevant drop down option in the "Configure processor for" parameter.

Please refer to the topic [EDK Export Tool](#) for more information.

## Designing with Embedded Processors and Microcontrollers

### Designing PicoBlaze Microcontroller Applications

The PicoBlaze™ block in System Generator implements an 8-bit microcontroller. Applications requiring a complex, but non-time critical state machine as well as data processing applications are candidates to employ this block. The microcontroller is fully embedded into the device and requires no external support. Any additional logic can be connected to the microcontroller inside the device providing ultimate flexibility.

#### PicoBlaze Overview

The following example uses PicoBlaze 3 (hereto referred to simply as PicoBlaze), which is optimized for low resource requirements. A memory block is used as a program store for up to 1024 instructions.

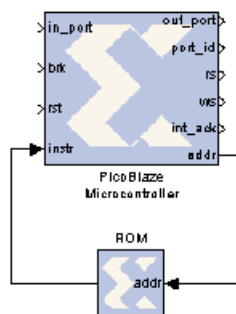

Signal	Direction	Description
in_port[7:0]	Input	Input Data Port. During an INPUT operation, data is transferred from the port to a register.
brk	Input	Interrupt. Must be at least two clock cycles in duration.
rst	Input	Reset
instr[17:0]	Input	Instruction Input.
out_port[7:0]	Output	Output Data Port.
port_id[7:0]	Output	Port Address.

Signal	Direction	Description
rs	Output	Read Strobe.
ws	Output	Write Strobe.
addr[9:0]	Output	Address of the next instruction.
ack	Output	Interrupt Acknowledge.

### Architecture Highlights

- Predictable performance, two clock cycles per instruction
- 43 - 66 MIPS (dependent upon device type and speed grade)
- Fast interrupt response
- 96 slices, 0.5 to 1 block RAM
- 16 8-bit general-purpose registers
- 64-byte internal RAM
- Internal 31-location CALL/RETURN stack
- 256 input and 256 output ports

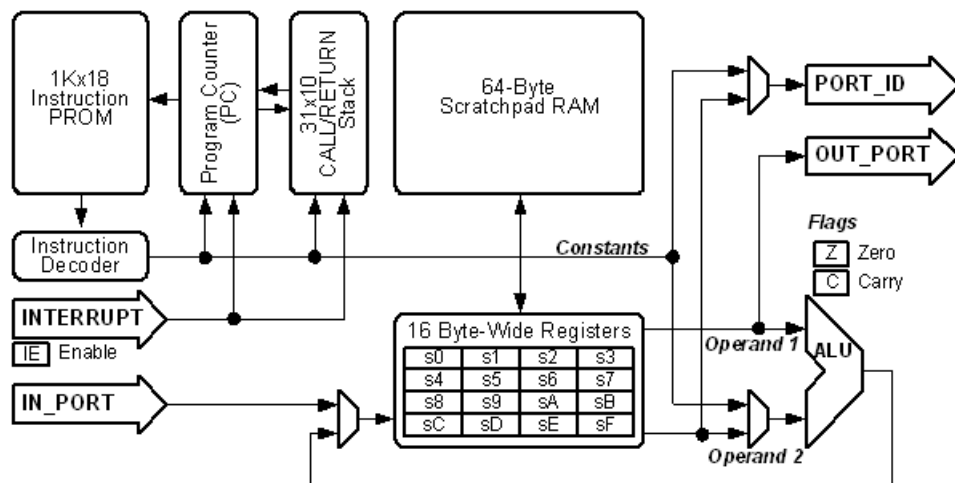

### PicoBlaze Instruction Set Architecture

PicoBlaze is a hardware-centric microcontroller, which can be programmed using assembly code. It supports a program length up to 1024 instructions. Requirements for larger program space are typically addressed by using multiple microcontrollers.

### 16 General Purpose Registers

There are 16 8-bit general-purpose registers specified 's0' to 'sF'.

## ALU

The Arithmetic Logic Unit (ALU) provides operations such as **add**, **sub**, **load**, and, **or**, **xor**, **shift**, **rotate**, **compare**, and **test**. The first operand to each instruction is a register to which the result is stored. Operations requiring a second operand can specify either a second register or an 8-bit constant value.

## Flags and Program Control

The result of an ALU operation determines the status of the zero and carry flags. The zero flag is set whenever the result is zero. The carry flag is set when there is an overflow from an arithmetic operation. The status of the flags can be used to determine the execution sequence of the program using conditional program flow control instructions such as **jump** and **call**.

## Input/Output

There are 256 input ports and 256 output ports. The port being accessed is indicated by an 8-bit address value provided on `port_id`. The port address can be specified in the program as an absolute value or indirectly specified as the contents of a register. During an **input** operation, the value provided to `in_port` is transferred into any of the 16 registers. During an output operation, a value is transferred from a register to `out_port`.

## Interrupt

The processor provides a single interrupt input port, `brk`. When interrupts are enabled, setting `brk` to 1 causes the program counter to be set to memory location 0x3FF, where a jump vector to the interrupt service routine is stored. At this time, a pulse is generated on the `ack` port (two clock cycles after `brk` is asserted), the control flags are preserved and further interrupts are disabled. The **return** instruction ensures that the end of an interrupt routine restores the status of the control flags and specifies if future interrupts should be enabled.

For extensive details regarding the feature and instruction set, please refer online to the topic [PicoBlaze User Resources](#).

## Tutorial Example - Using PicoBlaze in System Generator

In the following example, you modify a PicoBlaze program that alters the output frequency of a Direct Digital Synthesizer (DDS) during an interrupt.

A Simulink model and PicoBlaze assembler code are provided but need modification.

1. From the MATLAB console, change directory to `<ISE_Design_Suite_tree>/sysgen/examples/picoblaze`. The following files are located in this directory:
  - ◆ **Pico\_dds.mdl** – An unfinished Simulink model
  - ◆ **Pico\_code.psm** – Unfinished PicoBlaze code
2. Open `Pico_dds.mdl`.
3. Modify the design.
  - a. Find the PicoBlaze block in the Xilinx Blockset Library under Index or Control Logic and add it to the model where indicated. The default settings of the block do not give the same number of ports as is expected by the model. This will be corrected in the following step. You may need to resize the block to fit into the space allocated in the design.



- b. Double-click the block and set **Version** to **PicoBlaze 3**. Turn off the option to **Display internal state**. Connect the ports to the existing lines in the model.

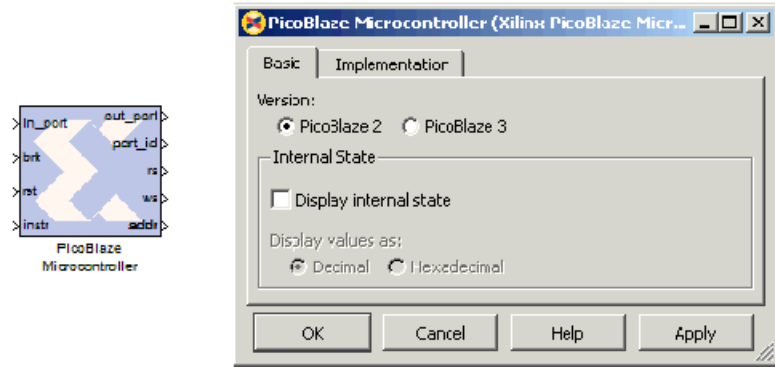

- c. Find the *PicoBlaze Instruction Display* block in the Index or Tools Library and add it to the model where indicated. Make sure it is connected properly, as shown in the figure below:

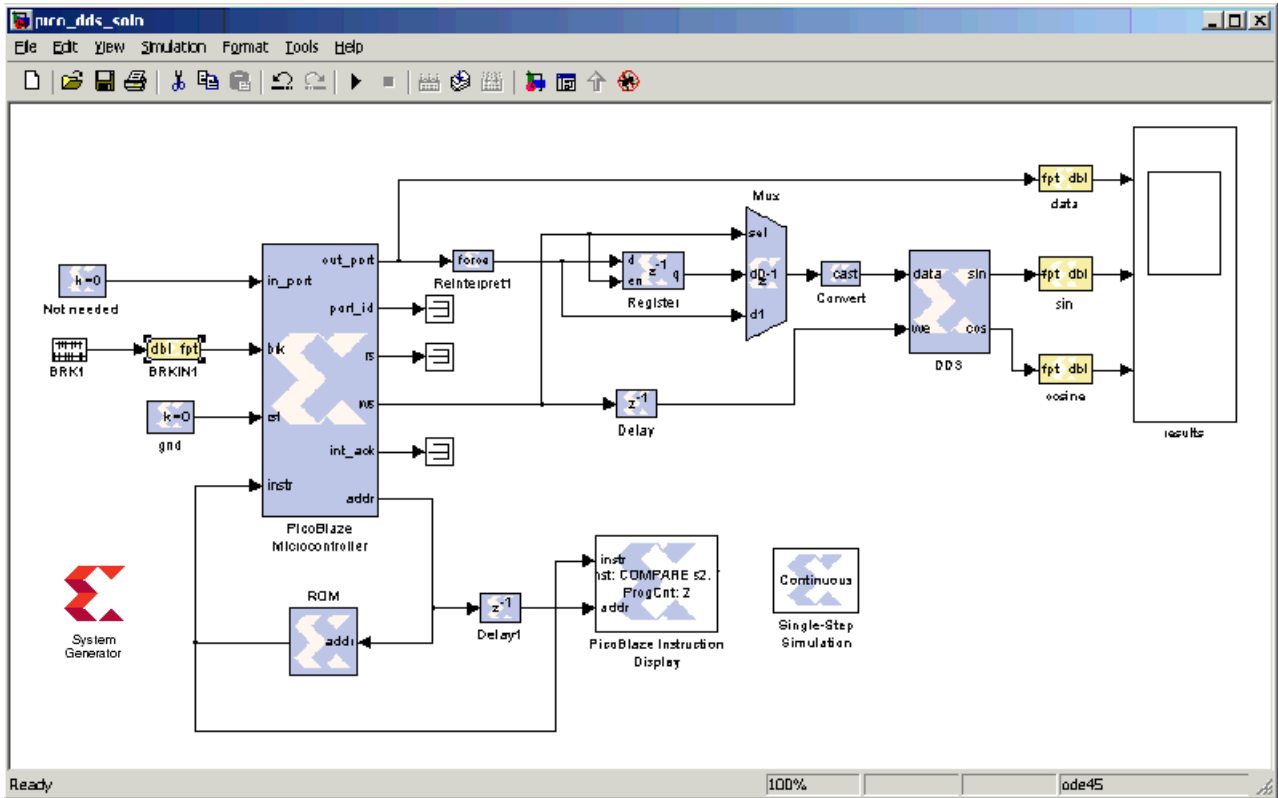

- d. Double-click the *PicoBlaze Instruction Display* block and set the **Version** to **PicoBlaze 3**. Check the **Disable Display** option. Disabling the display option allows the simulation to run without the overhead of updating the block display.

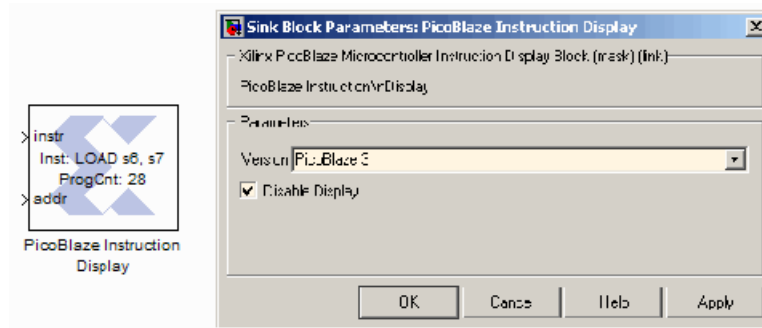

- e. Find the *ROM* block in the Memory Library and add it to the model where indicated. Flip the block by Right clicking on the block and selecting **Format > Flip Block**. Attach the ports to the existing lines.
  - f. Change the *Single-Step Simulation* block to be in continuous mode by double clicking on the block.
4. Configure the program store. Double click the ROM to do the following.
 

With the Basic tab selected:

    - a. The ROM block is used to store the PicoBlaze instructions. The depth of the ROM must be set to **1024**. This is because the program uses interrupts and setting `brk` to 1 causes the program counter to be set to `0x3FF`.
    - b. As detailed in step 5, the code is assembled and produces an initialization file for the memory named `fill_pico_code_program_store.m`. Hence the ROM Initial Value Vector should be set to **fill\_pico\_code\_program\_store**.
    - c. To increase the performance for synchronous designs, the Latency should be set to

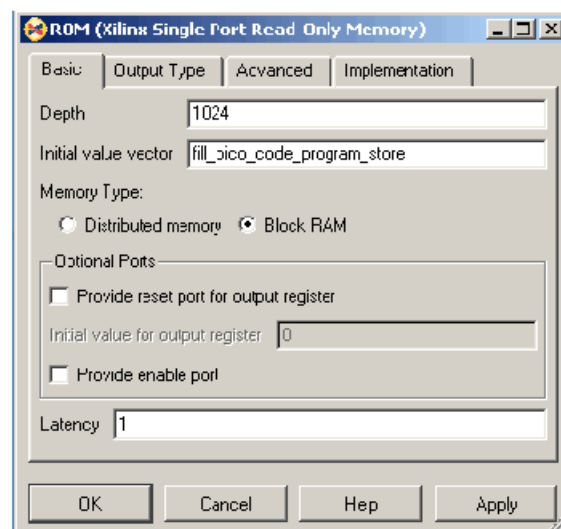

Click on the Output tab and enter the following:

- a. The Word Type should be **Unsigned** and Number of Bits should be set to **18** with the Binary Point at **0**.

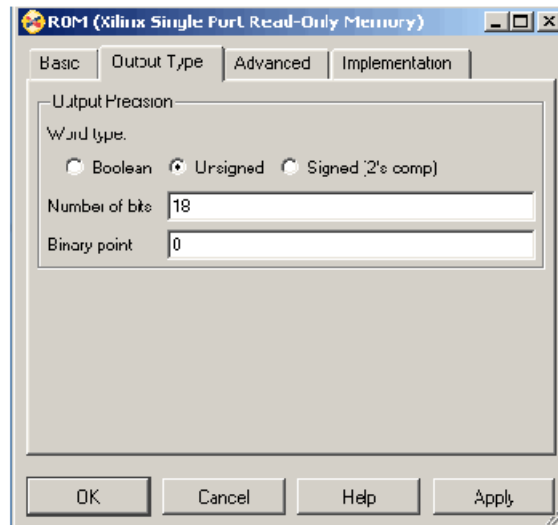

5. Edit the PicoBlaze assembly program.
  - a. Open `pico_code.psm`.
  - b. Add instructions as described in the `pico_code.psm` file. For detailed information about the PicoBlaze instruction set see the Xilinx Application Note XAPP627 at [http://www.xilinx.com/support/documentation/application\\_notes/xapp627.pdf](http://www.xilinx.com/support/documentation/application_notes/xapp627.pdf)
  - c. Save the file.
6. Run the assembler to generate the memory initialization file.

**Note:** The Xilinx PicoBlaze Assembler is only available with the Windows Operating System. Third-party PicoBlaze Assemblers are available for Linux, but are not shipped by Xilinx.

In the MATLAB command window, type:

```
>> xlpb_as -p pico_code.psm
```

`xlpb_as` stands for Xilinx PicoBlaze Assembler.

A file named `fill_pico_code_program_store.m` was created.

7. Simulate the Simulink model.

Run the simulation by clicking on the **Start Simulation Icon**.

Output should look like this:

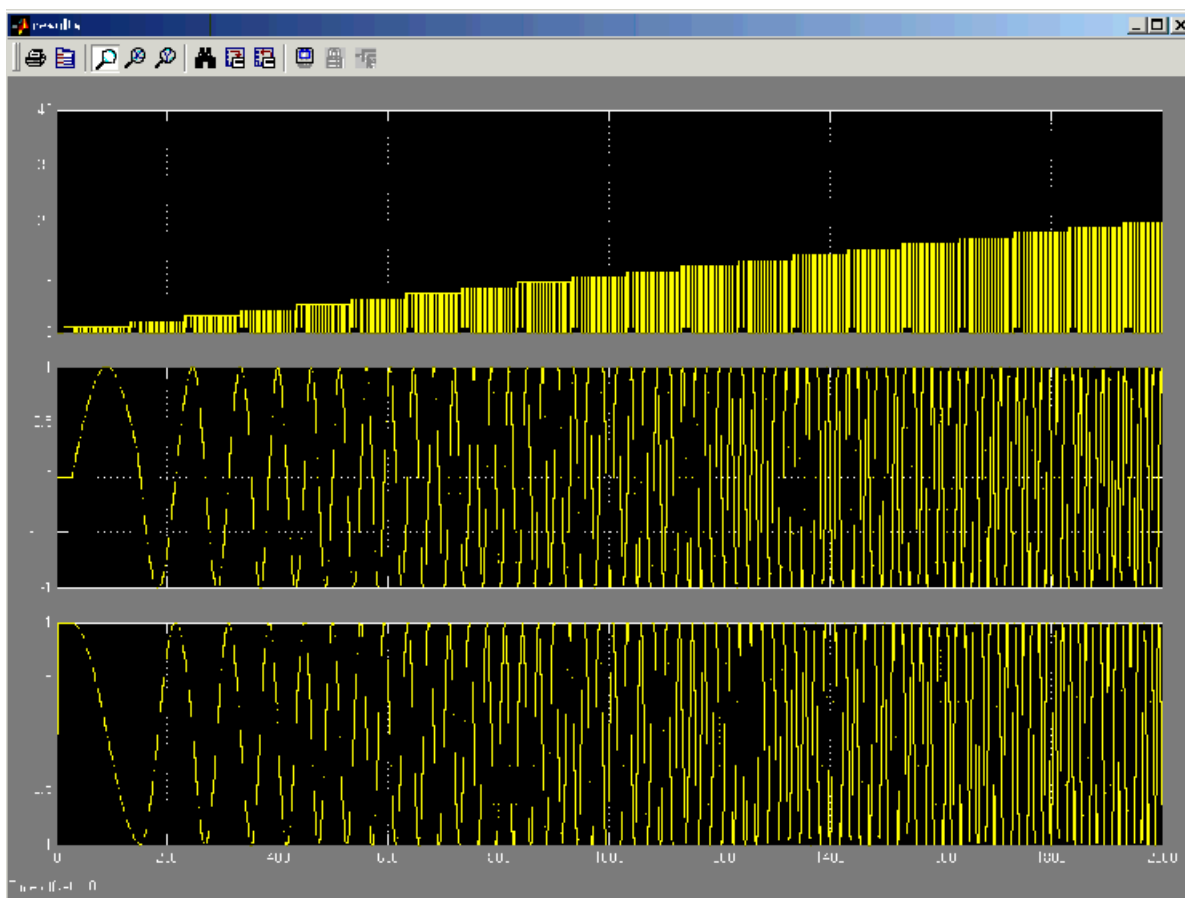

Notice the sine wave frequency increasing proportionally to the phase increment.

#### 8. Utilize Debug Tools

If the program is not working properly, there are several tools that can be utilized to ease debugging. Deselecting the **Disable Display** checkbox in the PicoBlaze Instruction Display block causes the block to be activated, displaying the updated program counter and instruction each clock cycle. In conjunction with enabling the display, the registers and control flag values can be viewed by selecting the **Display Internal State** in the PicoBlaze Microcontroller block. Change the *Single-Step Simulation* block to single-step mode by double clicking on the block. Step through the simulation to debug.

## Designing and Exporting MicroBlaze Processor Peripherals

The Xilinx Platform Studio (XPS) tool suite allows the development of customized MicroBlaze™ and PowerPC® processor systems. A hardware peripheral of the processor system is called “pcore”, which consists of a bundle of design files organized according to a specific structure. These design files describe the hardware implementation, the connection interface, and software drivers of the XPS pcore.

The EDK Processor block in conjunction with the [EDK Export Tool](#) allows customized processor hardware peripherals to be designed in System Generator. A System Generator design can be exported as an XPS pcore, which can be included and used in an XPS project.

The following exercise illustrates how to create a XPS pcore using System Generator. The files used in this exercise can be found in:  
<ISE\_Design\_Suite\_tree>/sysgen/examples/EDK/rgb2gray, where  
<ISE\_Design\_Suite\_tree>/sysgen denotes the System Generator installation directory.

## Tutorial Example - Creating a MicroBlaze Peripheral in System Generator

**Note:** You must have EDK installed to complete this exercise.

### Prerequisites

The exercise assumes that you have the following items installed on your computer.

- ISE Design Suite 14
- Windows 7 (64 bit)
- MATLAB R2011a (or greater).
- Spartan6 SP601 Evaluation Platform

### Copy the export\_pcore Example Directory to Your Local Drive

1. Copy the export\_pcore example folder to your C:\drive.

You should see the following subfolders and files:

#### edk

- C:\export\_pcore\edk\system.xmp  
This is a pre-configured XPS project.

#### source

- C:\export\_pcore\source\rgb2gray.mdl  
This is a System Generator design that will be exported as a pcore.
- C:\export\_pcore\source\rgb2gray.c --provided C code  
This is a C code application program that will be used to drive the System Generator pcore and the processor-based hardware design from the Software Development Kit (SDK).

### Export the System Generator Design as a pcore

1. Launch MATLAB and from the MATLAB console, set the current directory to C:\export\_pcore\source.

- Open the `rgb2gray.mdl` model.

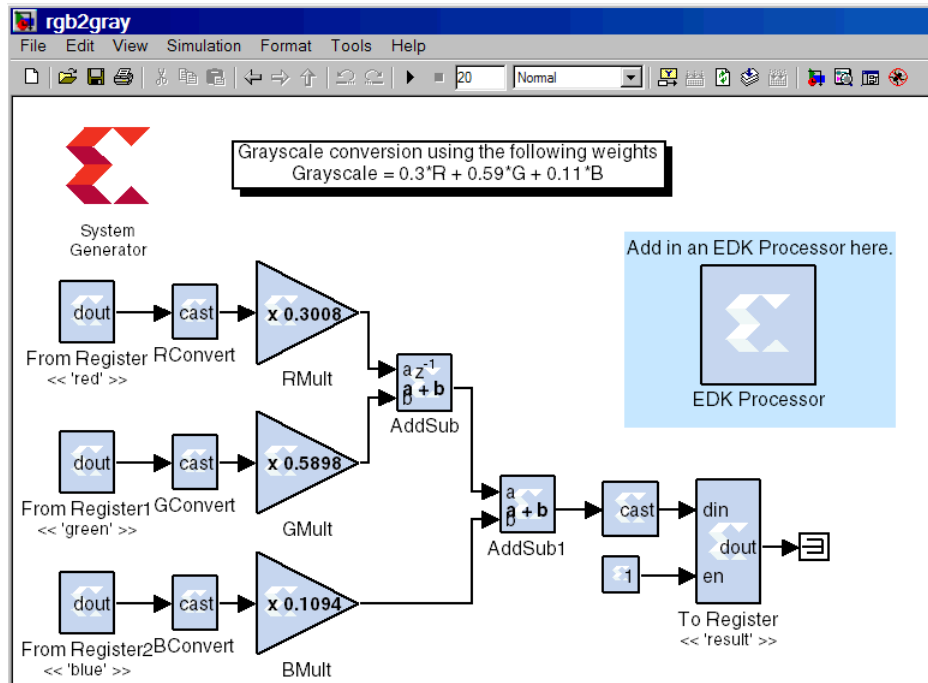

Notice that the EDK Processor block has already been added to this model.

- Click on the System Generator token and generate a pcore using the **Export as a pcore to EDKflow**.

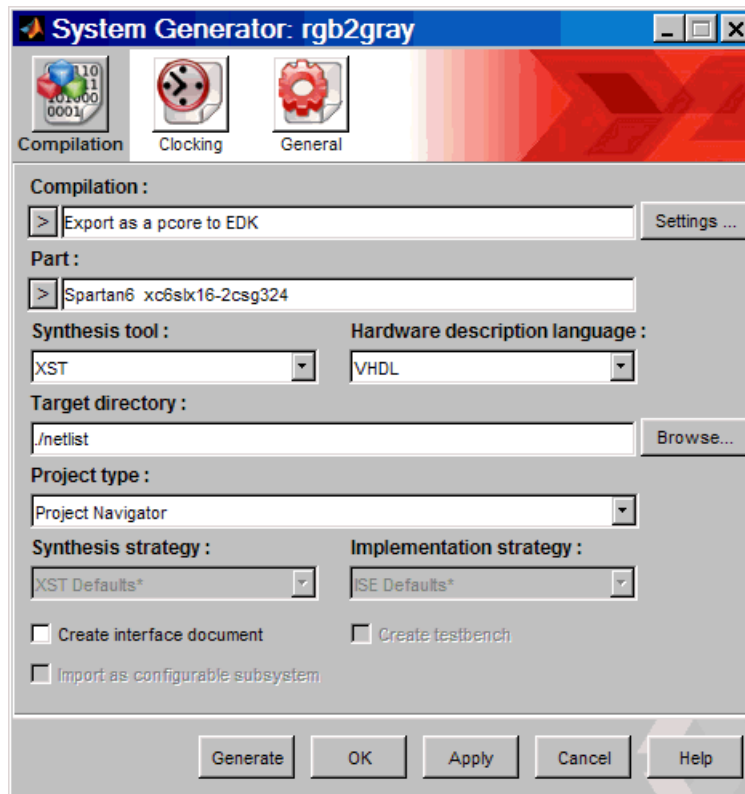

As shown above, set the Compilation type to be **Export as a pcore to EDK**. Click on the **Settings...** button to open up options for the compilation target. Accept the default settings so that the pcore is generated and exported into the model's target directory.

Click on the **Generate** button to initiate the pcore export process.

**Note:** This should take less than 5 mins.

- Open the provided XPS project at pathname C:\export\_pcore\edk\system.xmp. Under the IP Catalog tab select **Project Local PCores > Users**. You should see the pcore as shown below:

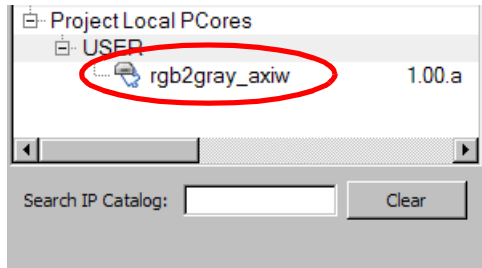

- Select all the default settings from the popped up dialog windows.

### Add the pcore to the Embedded Design

- Next, add the pcore into the embedded design. You can either use your mouse to drag and drop the pcore into the System Assembly View or you can right-click on the pcore instance and select **Add IP**.
- Connect a clock to the system pcore. From the System Assembly View, select the following: **Port tab > rgb2gray\_axiw\_0 > connect to 50 MHz clock**, as shown below::

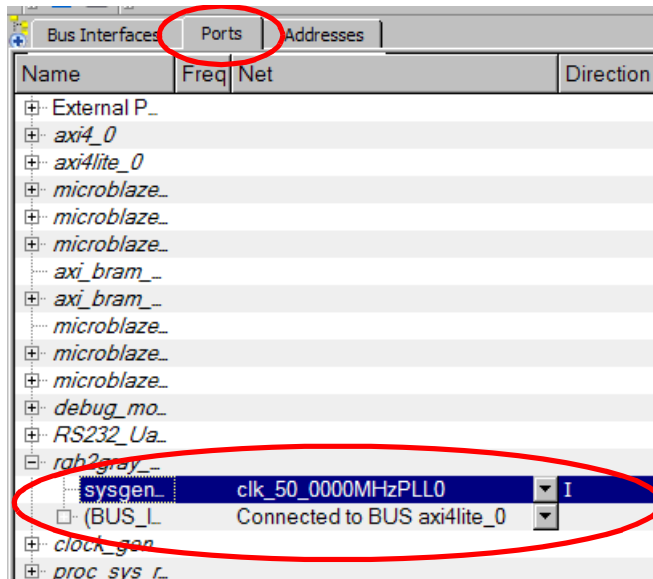

## Export the Embedded Hardware Design to SDK

Now you are ready to export an embedded hardware design to the Software Development Kit(SDK): click on Export Hardware Design to SDK as shown below:



1. Click on **Export & Launch SDK** as shown below:

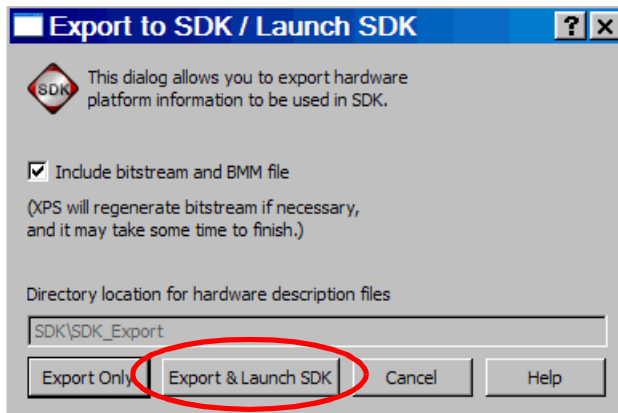

This will take about 15 minutes for this particular design because XPS has to generate a netlist and implement the entire design.

2. When you are asked to select a workspace, you can specify the following path:  
C:\export\_pcore\edk\SDK

## Embedded Flow with SysGen Pcore/XPS/SDK

1. From the SDK main menu, select **Xilinx Tools > Repositories**.
2. Click on **New...** and point to C:\export\_core\edk and then click **OK**.  
This is where the XPS project is located.

**Note:** If you skip this step, SDK won't be able to find System Generator pcore instances such as shared memories.

3. Right click on **edk\_hw\_platform** and select **New > Project**. Select **Xilinx C Project** and click **Next >**
4. Select **Hello World** and then click **Finish**. This step creates a Xilinx C project file in SDK.



**Note:** Note: after this step, a board package and a default ELF file are automatically created for you and you should see something similar to the following in SDK:

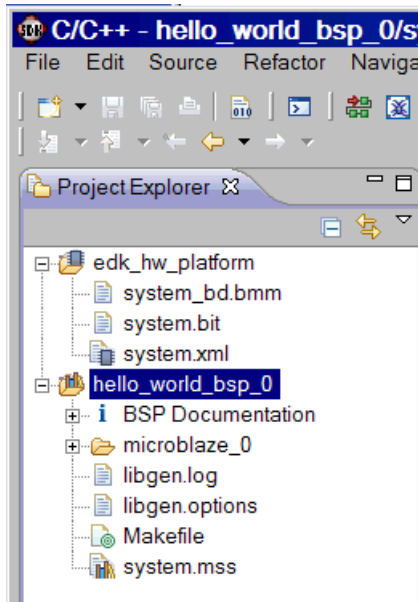

### Create a Software Application using SDK

In this next procedure, you will create a software application using SDK

1. Set the STDIO Connection. From the main SDK menu, select **Run > Run Configurations ...**
2. Double-click on the Xilinx C/C++ ELF. Select the **STDIO Connection** tab.
3. Click on the **Connect STDIO to Console** radio button, select an active channel like COM1 or COM2 and then click **Apply**.

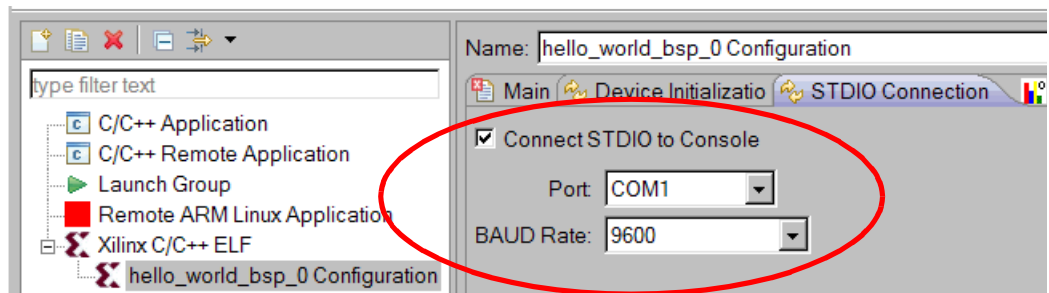

**Note:** You cables need to be connected to the SP601 - both the UART and JTAG cables

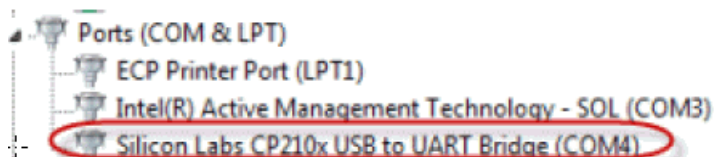

- Find and delete the `helloworld.c` file that was auto created by the tool as an example and replace it with the provided C code from `C:\export_pcore\source\rgb2gray.c` as shown below:

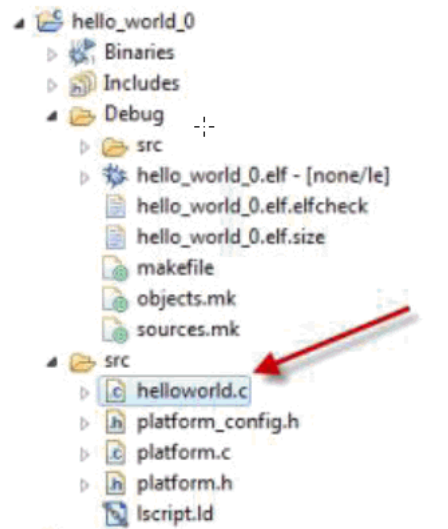

**Note:** Note: the easiest way to add a new source file is to drag and drop from Window Explorer. Once added, SDK should auto compile and if things go as planned, you should see the following compiling messages:

- Compile the Ccode and if things go as planned, you should see the following compiling messages:

```

Invoking: Xilinx ELF Check
elfcheck hello_world_0.elf -hw ../../hw_platform_0/system.xml -pe microblaze
elfcheck
Xilinx EDK 13.1 Build EDK_0.40d
Copyright (c) 1995-2010 Xilinx, Inc. All rights reserved.

Command Line: elfcheck -hw ../../hw_platform_0/system.xml -pe microblaze_0
hello_world_0.elf

ELF file      : hello_world_0.elf
elfcheck passed.
Finished building: hello_world_0.elf.elfcheck

```

- Now you're ready to configure and download a bit file to your SP601 evaluation board: from the main menu, select **Xilinx Tools > Program FPGA > Program**

- Execute the ELF file. Right-click on the elf file and select **Run As > Launch on Hardware**.

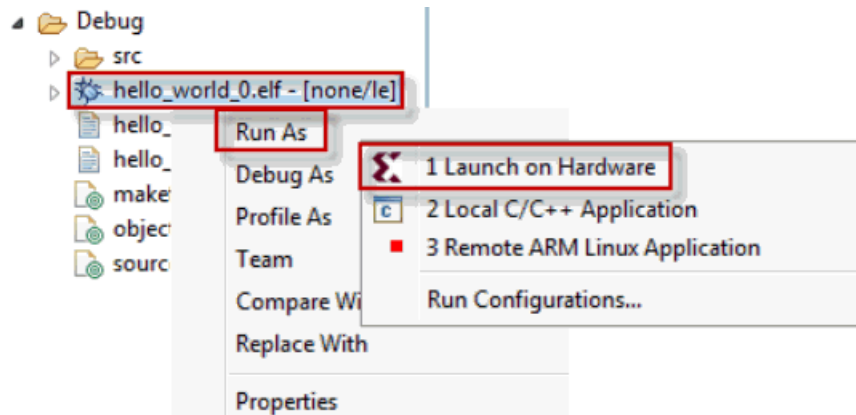

You should see the following messages echoed to the Console through the Uart peripheral:

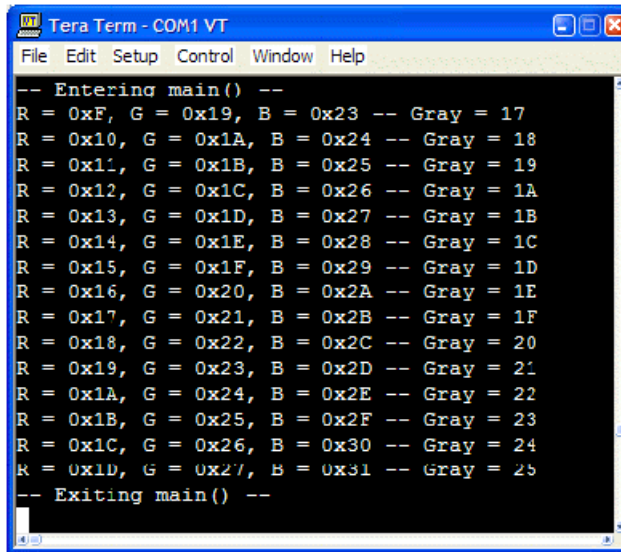

### Iterate Your Software

To iterate your software, you simply modify your `rgb2gray.c` file, save the file and then click **Run** (or **Play** button).



Try the following:

- Modify line 27 of your C code by changing `I` from 15 to 16.
- Re-run the C code file.

Did you see any differences on the Console?

## Tutorial Example - Designing and Simulating MicroBlaze Processor Systems

This topic shows an example on how to design and simulate a System Generator model containing a MicroBlaze™ processor. A DSP48 co-processor is developed using System Generator. Using the EDK Processor block, you import a MicroBlaze processor, customized in Xilinx Platform Studio (XPS), into the System Generator model. You then attach the DSP48 co-processor to the imported MicroBlaze processor through the automatic memory mapping mechanisms provided by the EDK Processor block.

This tutorial uses hardware co-simulation to simulate and verify the design. In this case, the MicroBlaze processor is compiled into hardware, while the DSP48 co-processor model is left in the System Generator diagram for software simulation. In this example, the hardware simulation and software simulation communicate with each other using the point-to-point Ethernet co-simulation technology.

This tutorial example contains the following topics:

- Create an XPS Project
- Create a DSP48 Co-Processor Model
- Import an XPS Project
- Configure Memory Map Interface
- Write Software Programs
- Create a Hardware Co-Simulation Block
- Create a Testbench Model
- Update the Co-Simulation Block with Compiled Software
- Run the Simulation

This example uses the *Xilinx Virtex®-4 ML402 Evaluation Platform*.

The files used in this tutorial can be found a pathname:

<ISE\_Design\_Suite\_tree>/sysgen/examples/EDK/DSP48CoProcessor, where <ISE\_Design\_Suite\_tree>/sysgen denotes the System Generator installation directory.

## Create an XPS Project

First of all, you will need to create a new XPS project, which contains an PLB-based UART peripheral. A tutorial on how to create a new XPS project can be found in the topic [Using XPS](#).

## Create a DSP48 Co-Processor Model

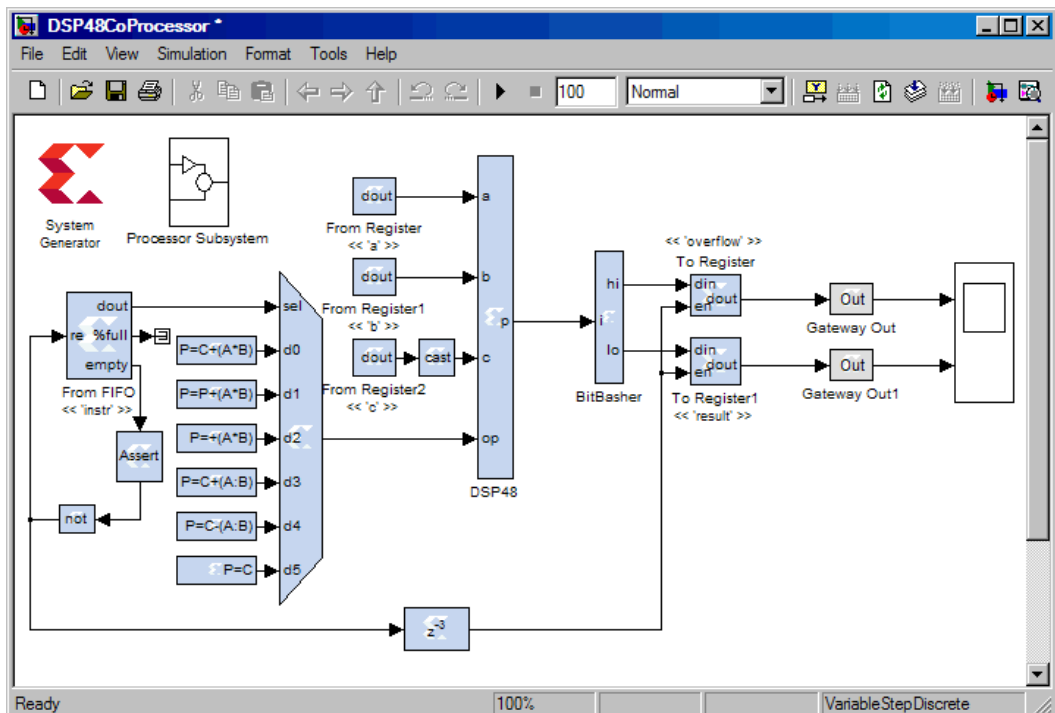

Copy the DSP48CoProcessorModel found in the folder <ISE\_Design\_Suite\_tree>/sysgen/examples/EDK/DSP48CoProcessor into a temporary working directory, then open the model.

The model contains a DSP48 block with the a, b, and c ports fed from three shared *From Registers* with corresponding names. The op port receives signals from a multiplexer whose select line is sourced from a shared *From FIFO* named instr.

The output port p of the DSP48 block is sliced and fed into another two shared *To Registers*: the top 16 bits into the overflow register and the bottom 32 bits into the result register.

## Import the XPS Project

In this step, you import an XPS project that contains a MicroBlaze processor into the DSP48 Co-Processor model. Double click on the subsystem called *Processor Subsystem* and look into it. In that subsystem, you will find a System Generator token and a blue text box as the place holder for an EDK Processor block. Open the System Generator block set and drag an EDK Processor block from the Index library into the Processor Subsystem. Your augmented subsystem should look like the one shown below:

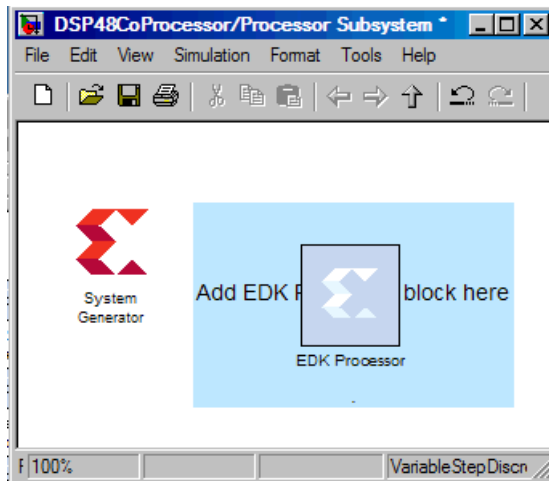

You will now configure the EDK Processor block to import the XPS project. The import process will make changes to the XPS project. Thus, ensure that the XPS project is *not* currently opened by Xilinx Platform Studio before importing.

Double click on the processor block to bring up the block dialog box. In the **Configure processor for** drop-down menu, select **HDL netlisting**. The **Import...** button is enabled as a result of the selection.

Note that the **Import...** button is disabled when the processor is configured for *EDK pcore generation*. In *EDK pcore generation* mode, it is expected that you will create a pcore in System Generator and export it to be used in another XPS project. In this case, the processor is not instanced inside the EDK Processor block. In **HDL netlisting** mode, it is expected that you import an XPS project into the System Generator model and netlist it with other System Generator blocks.

If no XPS project is ever imported, configuring the processor for **HDL netlisting** will automatically trigger the launching of the XPS Import Wizard. The XPS Import Wizard can be launched manually by pressing the **Import...** button.

In the pop-up file selection dialog, browse to the XPS project created in earlier steps. The import process starts once a XPS project file (xmp file) is selected. The import process copies necessary files into the XPS project and changes the project accordingly to allow the MicroBlaze processor to communicate with the System Generator model.

Note that if there is any software applications contained by the imported XPS project, they are not compiled during import.

## Configure Memory Map Interface

Re-open the dialog box of the EDK Processor block. Add all the shared memories in the model to the processor's memory map by selecting **<all>** in the **Available memories** pull-down menu and then press the **Add** button. The EDK Processor block dialog box should look like the following screenshot. Dismiss the dialog box by clicking the **OK** button at the bottom.

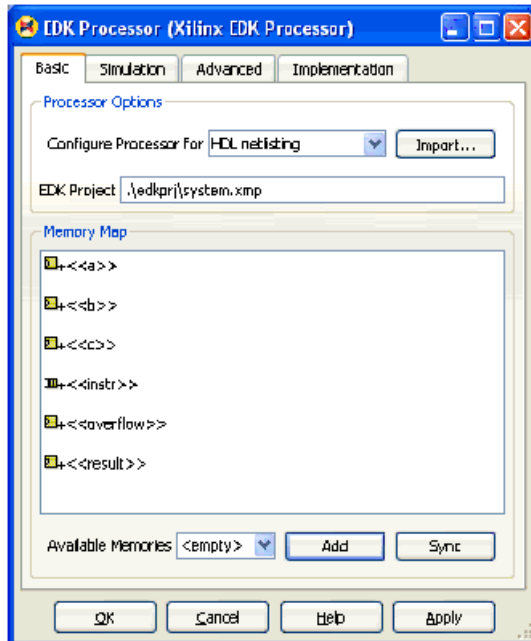

## Write Software Programs

You will write software programs running on MicroBlaze processor to read from and write to the shared memories. Re-open the XPS project in Xilinx Platform Studio. Create a new software application called *MyProject*. Make sure that the *MyProject* software application is marked for download into BRAM while the other software applications are unmarked. Refer to the topic [Using XPS](#) on how to add a new software application to an EDK project.

Create a new source code file *MyProject.c* for *MyProject* and open it in the XPS code editor.

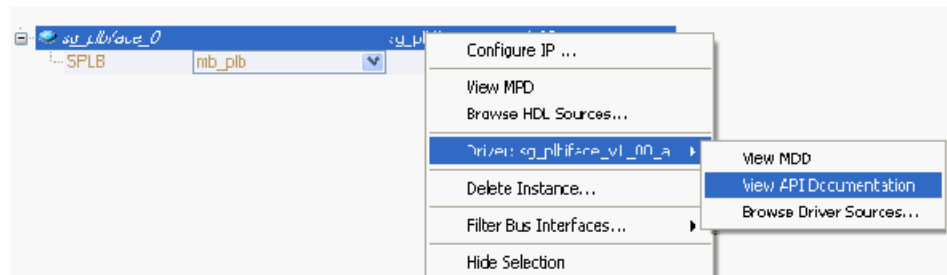

The above figure shows a portion of the System Assembly View of the XPS project in Xilinx Platform Studio. A *sg\_plbiface* peripheral is automatically added to an XPS project after it is successfully imported into System Generator. The *sg\_plbiface* peripheral connects the PLB bus attached to the imported MicroBlaze processor to the System Generator model through a memory-mapped interface, and to capture information on how to generate the

corresponding device software drivers. Right click on *sg\_plbiface* in the System Assembly View to see its API documentation.

Follow the instructions in the API documentation to include the following header file and initialize the software driver in `MyProject.c`.

```
#include "sg_plbiface.h"

xc_iface_t *iface;

// initialize the software driver
xc_create(&iface, &SG_PLBIFACE_ConfigTable[0]);
```

Before reviewing the code to run on the processor, first consider how to write data to the a register on the model. Look at the DSP48 Co-Processor model. Recall that the a port of the DSP48 block is driven by the output of a shared register by the same name. You want to write a value to that shared register from within MicroBlaze processor code. By referring to the driver API, you can see that the shared memory called a is a "To Register" memory type with *xc\_to\_reg\_t* access data type, which contains the following data fields:

```
typedef struct {
    xc_w_addr_t din;
    uint32_t n_bits;
    uint32_t bin_pt;
} xc_to_reg_t;
```

Once the software driver is initialized, `din` stores the memory-mapped address of the `din` port of the shared memory `a`, while `n_bits` and `bin_pt` store the number of bits and binary point information.

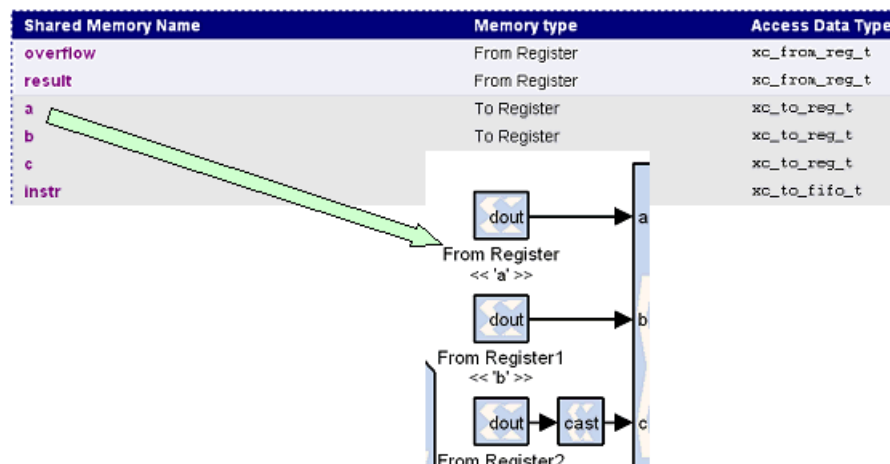

So in order to write a value to the a shared register, you need to first obtain the shared register settings through `xc_get_shmem` and thus:

```
xc_to_reg_t *toreg_a;
xc_get_shmem(iface, "a", (void **) &toreg_a);
```

**Note:** Calling `xc_get_shmem` is expensive. You should cache the returned `toreg_a` for later use and avoid calling `xc_get_shmem` multiple times in a program.



You can then use the following single-word write access function to write to the a shared register:

```
// -- Set the a port register to 2
xc_write(iface, toreg_a->din, 2);
```

Copy and paste the above code into your source code file `MyProject.c`

A reference copy of the full code of `MyProject.c` is located at the following pathname:

```
<ISE_Design_Suite_tree>/sysgen/examples/EDK/DSP48CoProcessor/MyProject
.c
```

## Create a Hardware Co-Simulation Block

The complete Simulink model can be simulated through hardware co-simulation. Make sure that the shared memories are added into the *Memory Maps* window and the EDK Processor block is configured for **HDL netlisting**. These are required for hardware co-simulation.

Open the dialog box of the System Generator token in the same subsystem as the EDK Processor block. You generate the hardware co-simulation block from this level of the model so that only the imported MicroBlaze processor runs in hardware while the rest of the design is kept in Simulink for software simulation.

Under the *Compilation* menu select **Hardware Co-simulation > ML402 > Ethernet > Point-to-point**. Next, press the **Generate** button to begin the compilation process. This may take some time. Upon completion, a hardware co-simulation block is created that contains a MicroBlaze processor.

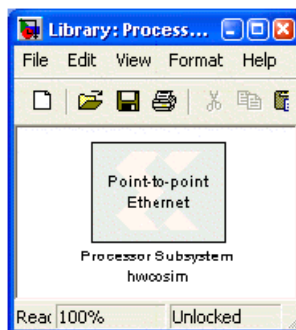

## Create a Testbench Model

A testbench model will be created to use the co-simulation block created in the previous step. Open the **DSP48CoProcessor** model and delete the Processor Subsystem. Copy the Processor Subsystem hwcosim block you just generated into the DSP48CoProcessor model. Save the model as `DSP48CoProcessor_testbench.mdl`.

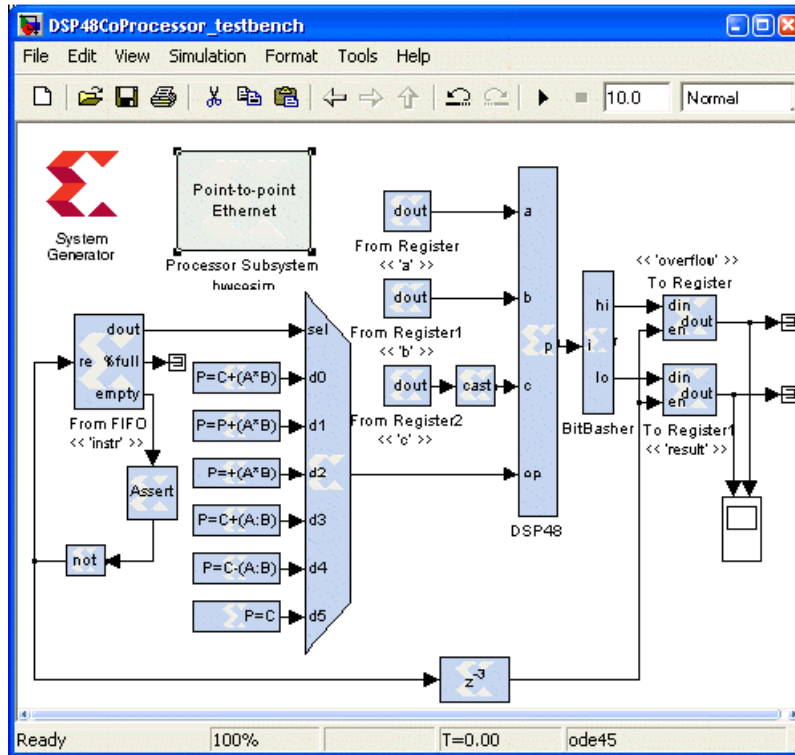

## Update the Co-Simulation Block with Compiled Software

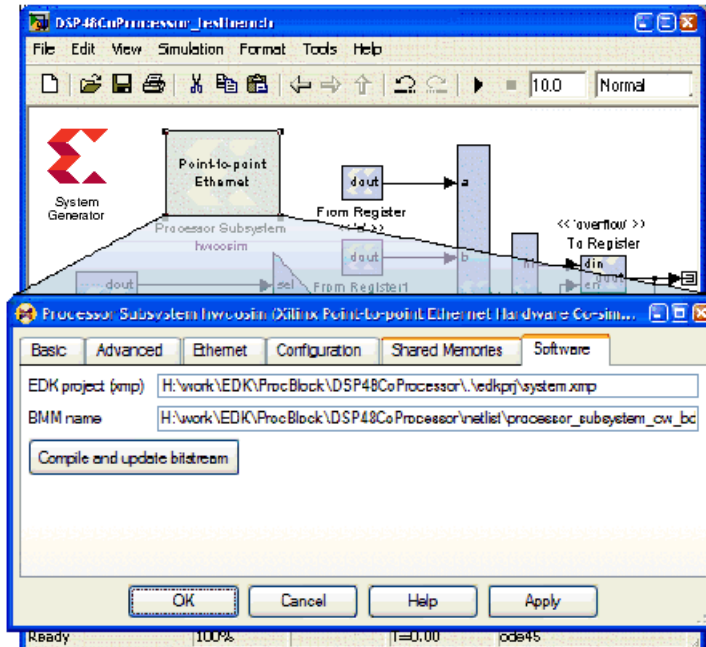

Return to the testbench model. Double click on the Processor Subsystem hwcosim block to bring up the dialog box shown above. To compile the software contained in the XPS project listed in the *Software* tab and load it into the hardware co-simulation bitstream, click the button labeled **Compile and update bitstream**.

Since Point-to-point Ethernet co-simulation is chosen, you need to configure the Ethernet interface and also the Configuration interface of the Processor Subsystem hwcosim block. Select a valid Host interface for your Ethernet communications, and set the configure interface to Point-to-point Ethernet. Refer to the topic [Using Hardware Co-Simulation](#) for more usage information of the hardware co-simulation block.

## Run the Simulation

Before starting the simulation, you need to set up a terminal connected to the COM port of your computer. This allows for text inputs and outputs to be read from and written to the MicroBlaze processor through the RS232 port.

Open up your favorite terminal program. Windows comes with a Hyperterminal application, which can be found in **Start > All Programs > Accessories > Communications > Hyperterminal**. Set up the terminal program to listen to the COM port that you have wired your RS232 to.

Configure your terminal as follows:

- Baud rate = 115200
- Data = 8 bits
- Parity = none
- Stop = 1 bit

- Flow control = none

Set the simulation time of the testbench model to inf, allowing enough simulation time for the MicroBlaze processor to wake up and respond.

## Using XPS

This topic provides a quick tutorial on several aspects of the [Xilinx Embedded Development Kit](#) (EDK). Please refer to the EDK documentation for more in depth explanations and tutorials.

### Tutorial Example - Creating a New XPS Project

The Base System Builder is an EDK Wizard to help you construct a fully configured EDK project. This topic walks you through creating an EDK project configured with a MicroBlaze™ Processor, running on a Xilinx ML402 hardware development board.

1. Launch Xilinx Platform Studio from the Windows start menu
2. When XPS launches, the following dialog should appear. Select **Base System Builder wizard (recommended)**, then click **OK**.

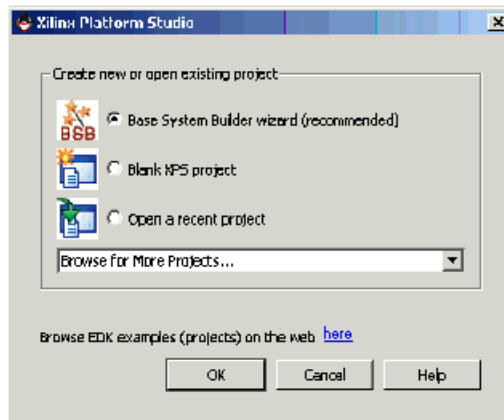

3. Next, specify the XPS project name as *system.xmp* and the location, as shown below, then click **OK**.

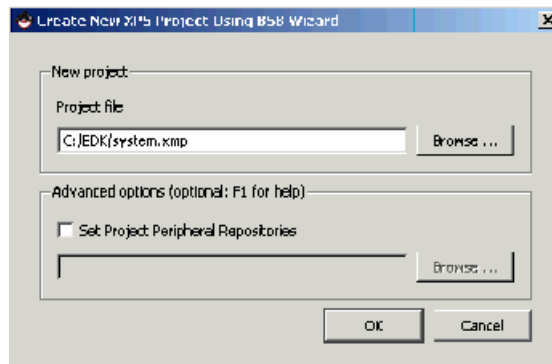

- Next, tell Base System Builder that you would like to create a new design, then click Next.

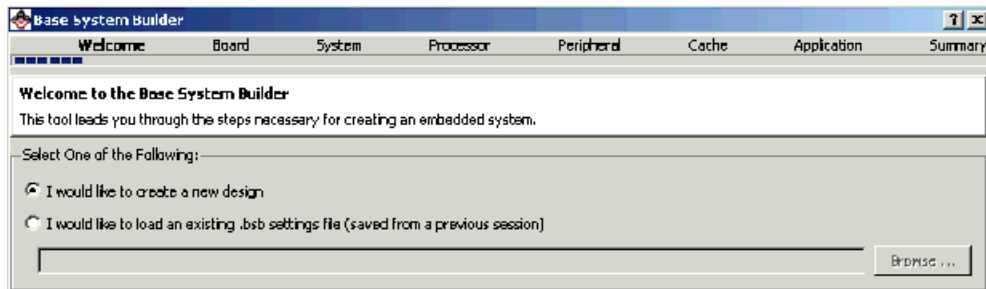

- Base System Builder – Select the Board Vendor and Board Name, then click Next.

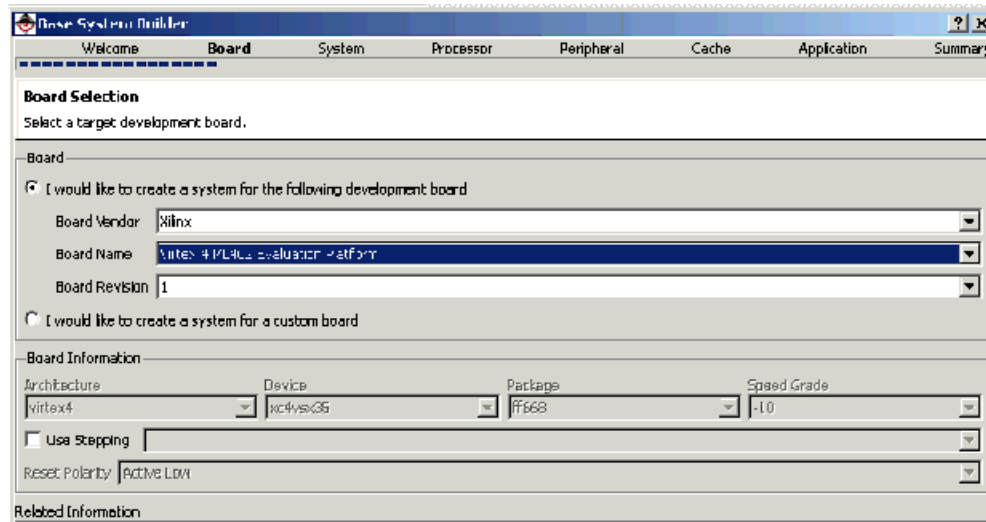

- Base System Builder – Select a Single Processor System, then click Next.

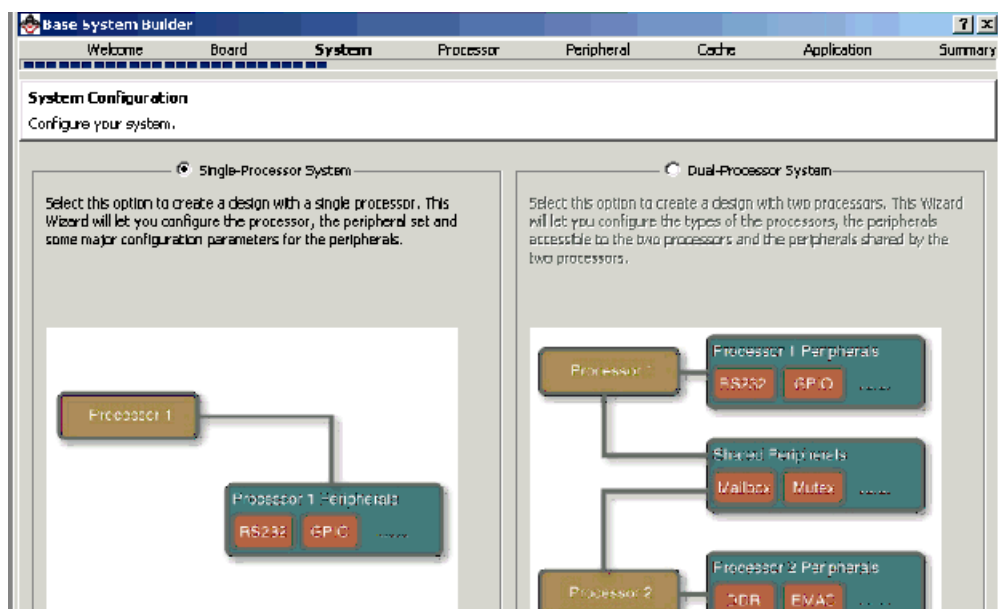

7. Base System Builder – Configure the **Reference Clock Frequency** and the **Local Memory**, as shown below, then click **Next**.

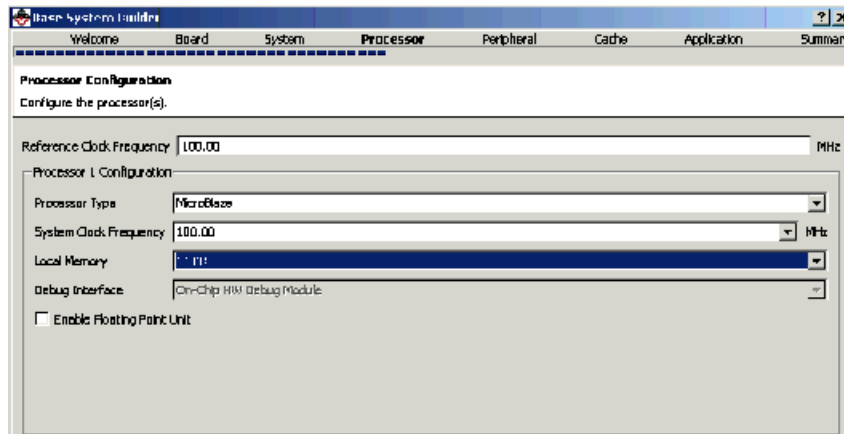

8. Base System Builder – Select **RS232\_Uart**, **dlmb\_cntlr** and **ilmb\_cntlr**. Remove other peripherals using the **Remove** button, then click **Next**.

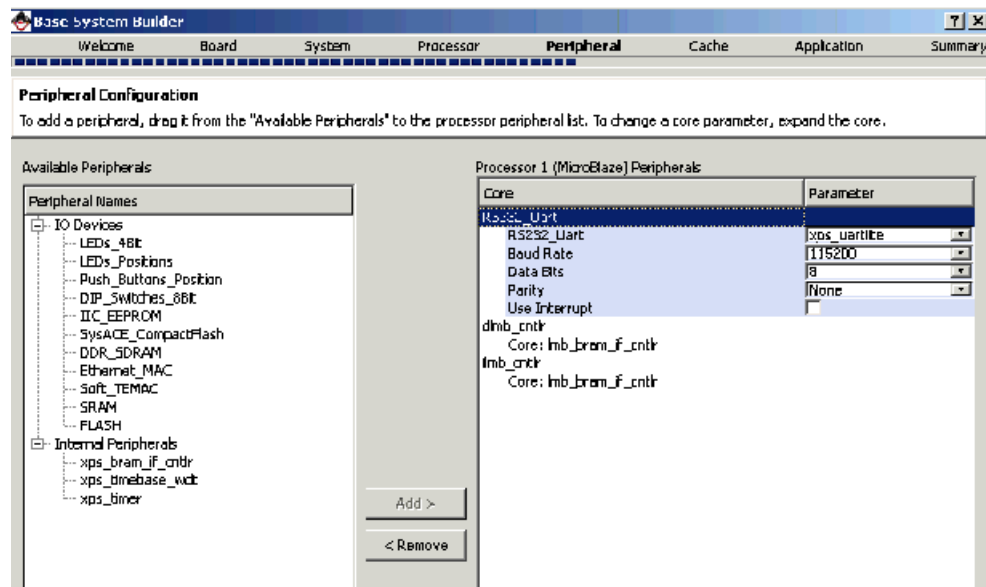

9. Base System Builder – Click **Next** in the **Cache configuration** dialog box.
10. Base System Builder – Click **Next** in the **Application configuration** dialog box.
11. Base System Builder – Click **Finish** in the Summary screen. At this point, the XPS project will be automatically generated.

## Adding a New Software Application

1. To add a new software application to an EDK Project, first open the EDK project in the EDK.
2. In the Project Information Area, click on the **Applications** tab to reveal the Software Projects page.

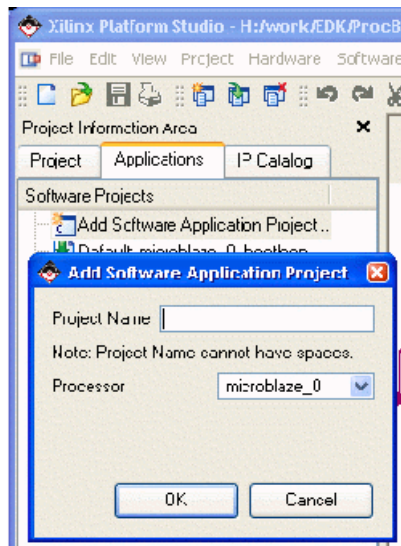

3. The first item on this page is **Add Software Application Project ...**. Double click on this to bring up the Add Software Application Project dialog box. Type in a project name, then click **OK**.
4. By default, the project is created and not set to be initialized into BRAMS. Make sure to initialize the project into BRAMS; otherwise, the software code will not be compiled and added to the bitstream. Also, if you have more than one application, ensure that all other applications have **Marked to Initialize BRAM** unchecked.

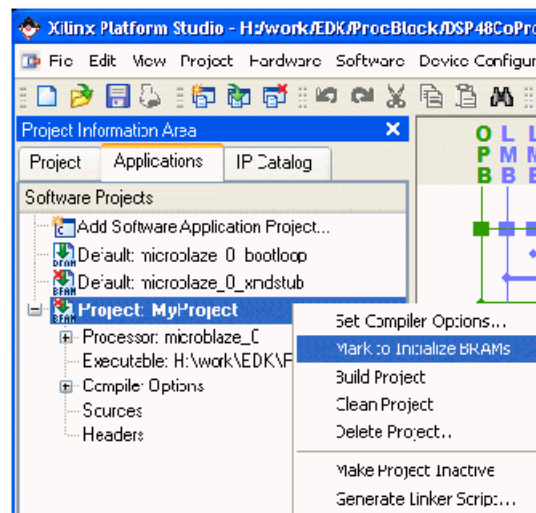

- Next, create Source or header files. Double click on the Sources branch of a project tree to cause a File Open Dialog to pop-up. The dialog is rooted at the base location of your EDK project. It is good to create a directory named after your project and keep your source and header files there; in this case, MyProject. Create the directory in the same directory as your EDK .xmp file

### Adding a pcore to an EDK Project

- Pcores in an EDK project must be in the user repository, or in a directory named pcores, at the same directory level as the EDK project file
- To ensure that the pcore has been loaded from XPS, select **Project > Rescan User Repositories**
- You may use the **Configure Co-processor** tool. The tool can be launched from XPS by selecting **Hardware > Configure Coprocessor...**

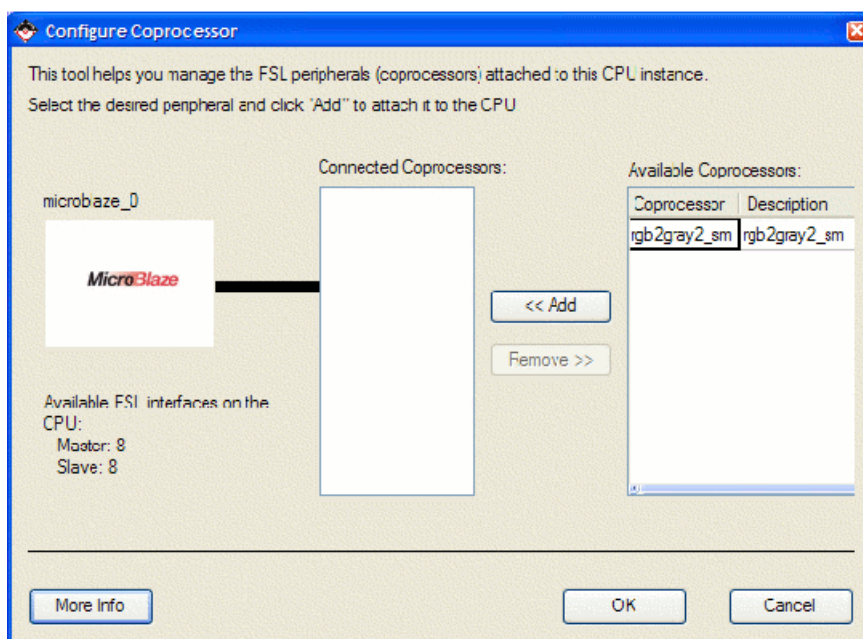

Available pcores are listed on the right hand window. Select the relevant pcore, then click on the **Add** button. The Configure Coprocessor tool takes care of connecting the clock and reset signals, however, any user signals must be wired up by you.



## Using Platform Studio SDK

### Introduction

The Xilinx Platform Studio Software Development Kit (SDK) is an Integrated Development Environment for creating software platform designs. The SDK is an eclipse-based IDE that makes it easier to write high-quality C/C++ code for Xilinx embedded processors. System Generator provides access to the SDK by automatically generating an SDK workspace and providing a "hello world" program template that contains example code which allows you to write productive code in a short period of time.

### Invoking the SDK

System Generator automatically generates an SDK workspace if an EDK Processor block is present during a Hardware Co-simulation compilation. Additionally, the Hardware Co-simulation token will have an additional tab in the block's GUI called **Software**. In this tab, there is a SDK panel that provides access to the SDK.

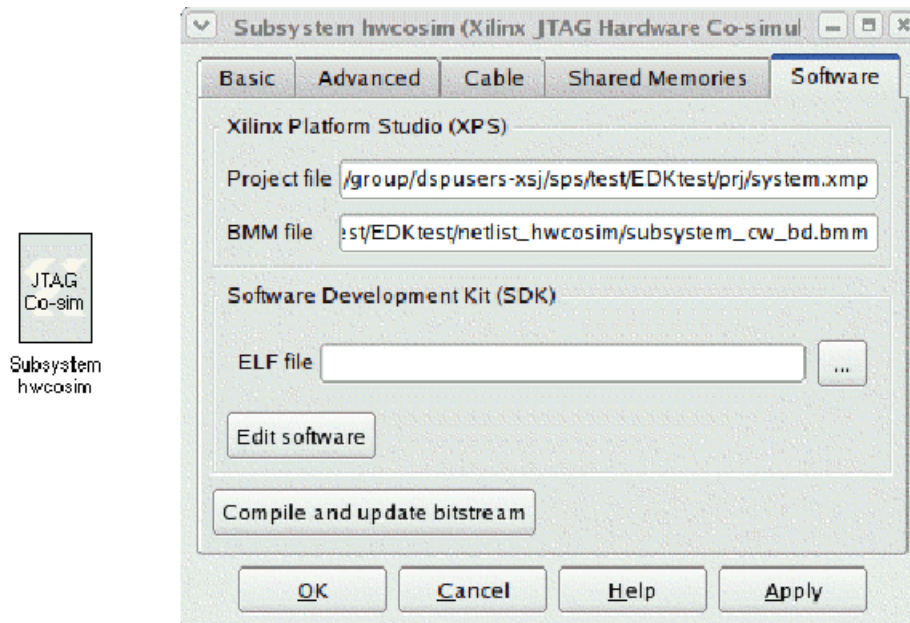

Pressing the **Edit software** button will launch the SDK. The SDK workspace can also be found under the netlist directory of the design. The **ELF file** field tells the Hardware Co-simulation block what executable binary to use during simulation, and the "Compile and update bitstream" takes the binary file specified in "ELF file" and merges it into the bitstream.

Please refer to documentation in the SDK regarding the creation of a software platform and a managed C or C++ project within the SDK.

## Creating a Hello World Application in SDK

When SDK is launched with a workspace created from System Generator, it is possible to create a C application project that has example code that shows how memories in System Generator can be read from and written to.

In the C/C++ Project navigation pane, right click on a Software Platform and select **New > Managed Make C Application Project**.

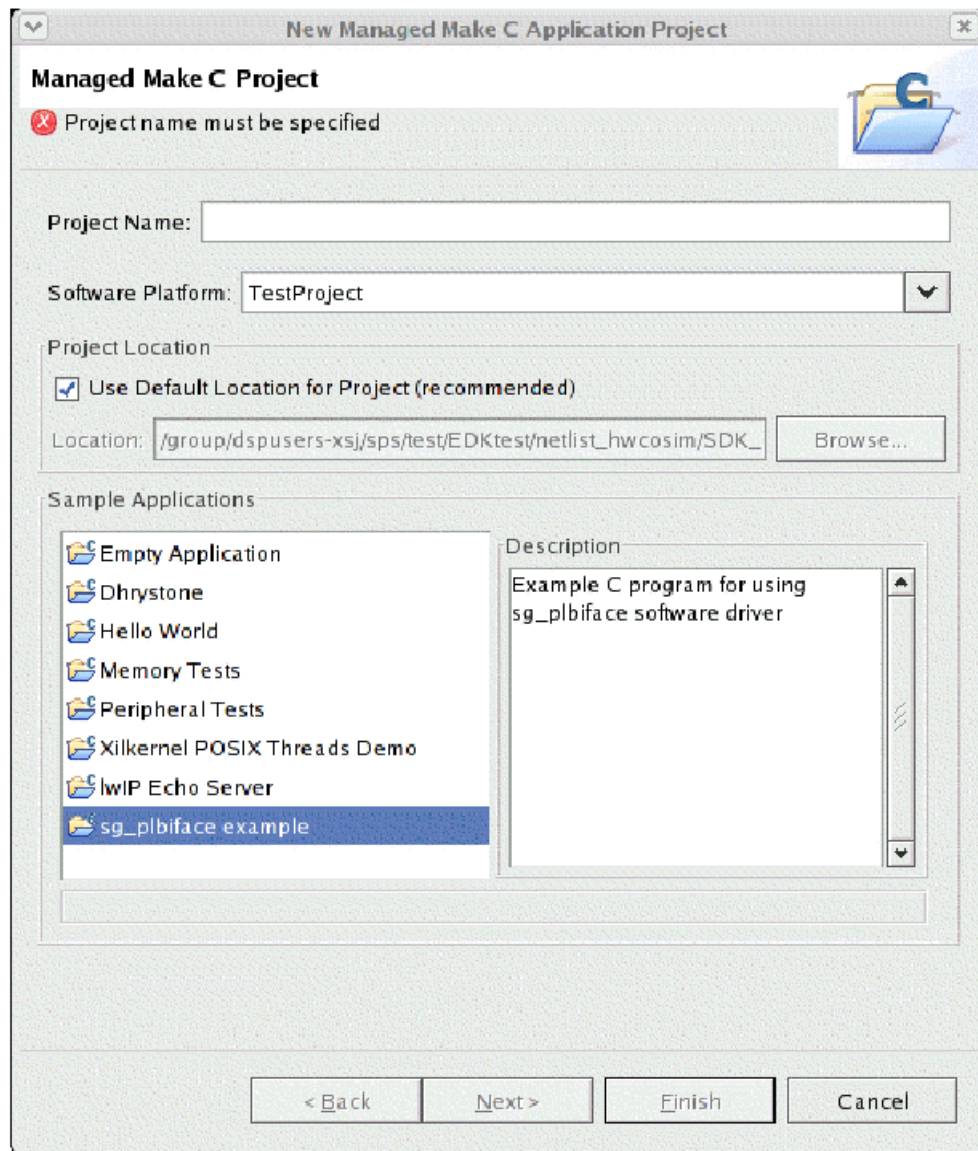

In the list of Sample Applications, select the **sg\_plbiface** example and click **Finish**. This creates a software project with a `main()` routine that prints "Hello World". The file also contains example functions that show how to access the memories in the System Generator design.

## Getting help on the Software Drivers Generated by System Generator

In the SDK menu, select **Hardware Design > View Design Report**. This will launch a web page that contains the resources available to this software platform. In the left hand navigation panel, select **Peripherals > sg\_plbiface\_0**.

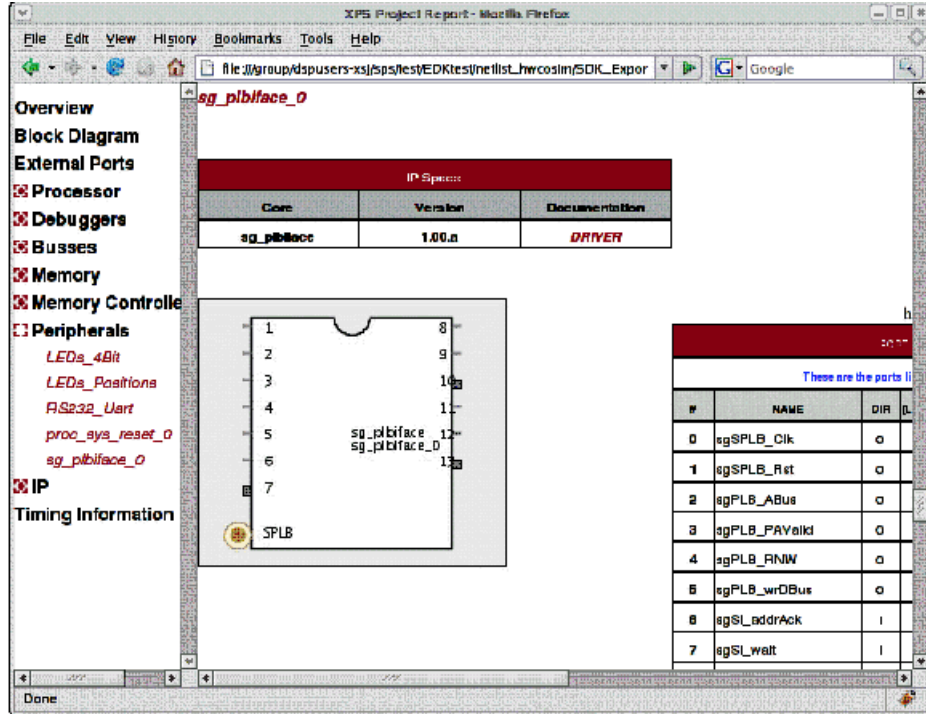

This will scroll the report into the section pertaining to the System Generator peripheral. In the IP Specs table, click on the **DRIVER** link and that will launch the documentation generated by System Generator for the peripheral.

## How to Migrate a Software Project from XPS to Standalone SDK

Adding and managing software applications in XPS is deprecated starting in release 11.1 and will become obsolete starting in release 12.1. You can still continue using an existing XPS project until 12.1, but it is highly recommend that you migrate the software portion to the Standalone SDK flow to take advantage of the flexibility and advanced features in adding and managing software. You can follow the step-by-step instructions described below on how to migrate from an existing XPS flow to an SDK design flow. The same generic steps can also be used on other Sysgen/EDK designs to accomplish the same migration paths between XPS and Standalone SDK.

## How to Migrate to the Standalone SDK Flow

In the following description, a design called VFBC will be used.

1. Open the System Generator model with the hardware co-sim block (vfbc\_hwcs.mdl). Double-click on the Hardware Co-Sim block and click on the **Edit** software button to launch SDK.

**Note:** Notice that you do not have to enter the ELF file yet at this point.

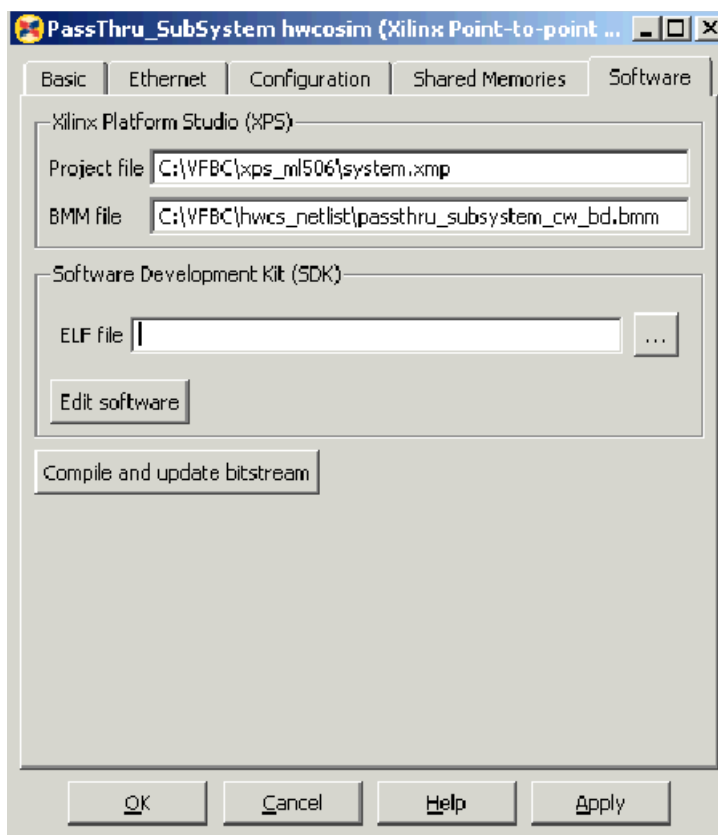

2. Click **OK** to start creating the software project.

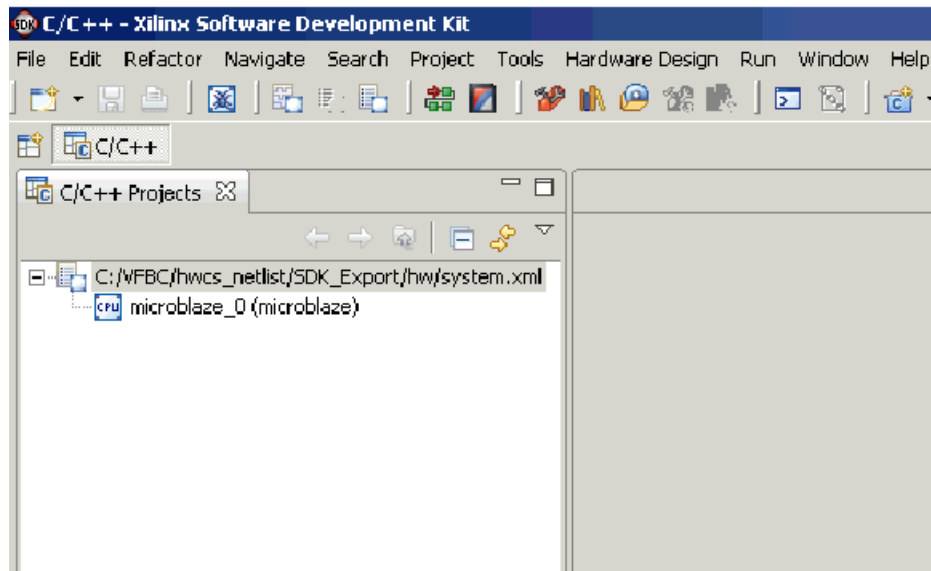
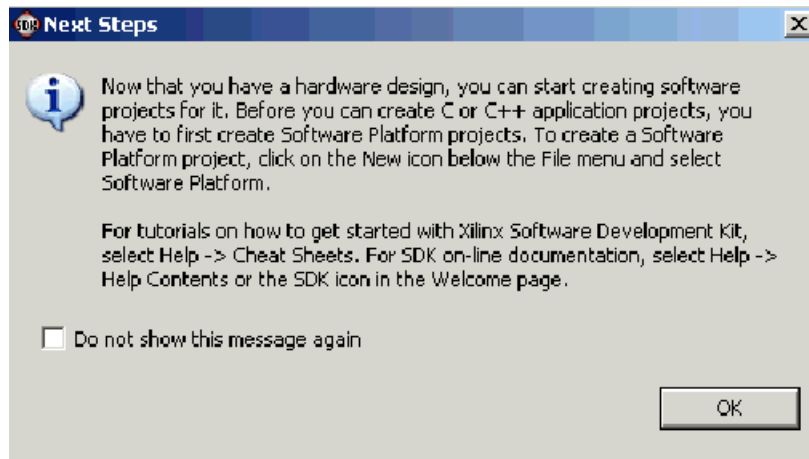

3. Right-click on the system.xml file and select **New > Project**

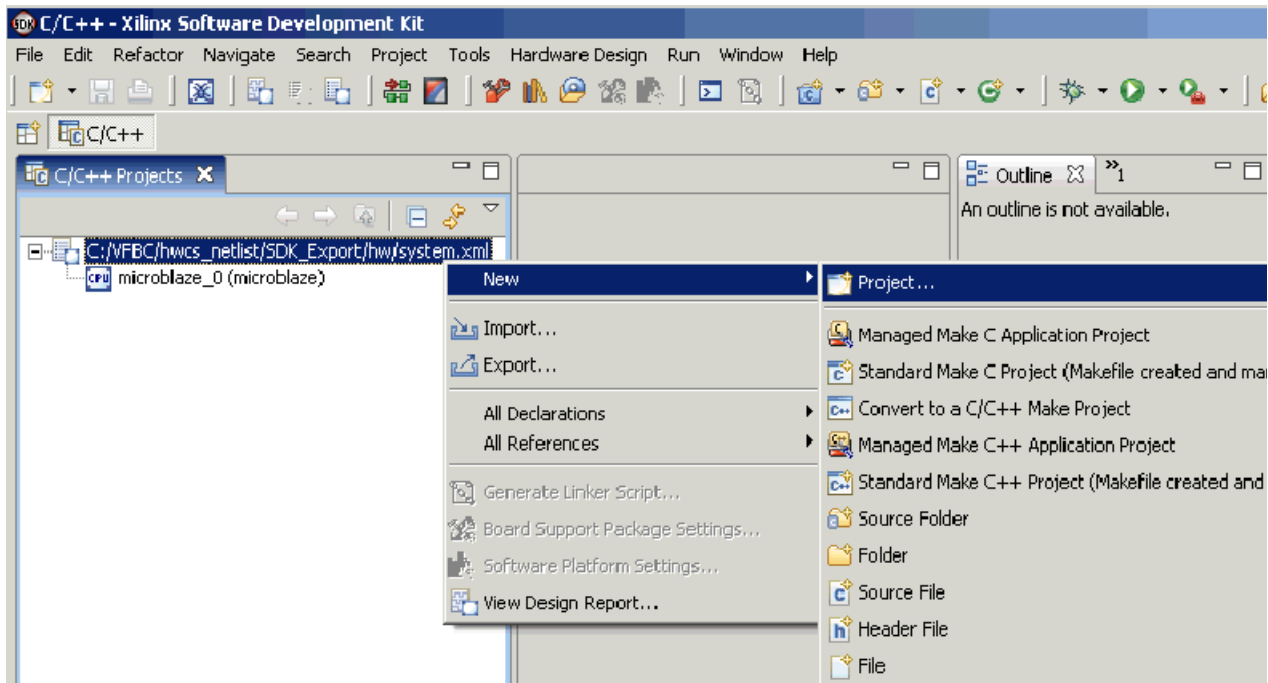

4. Select the Software Platform Wizard

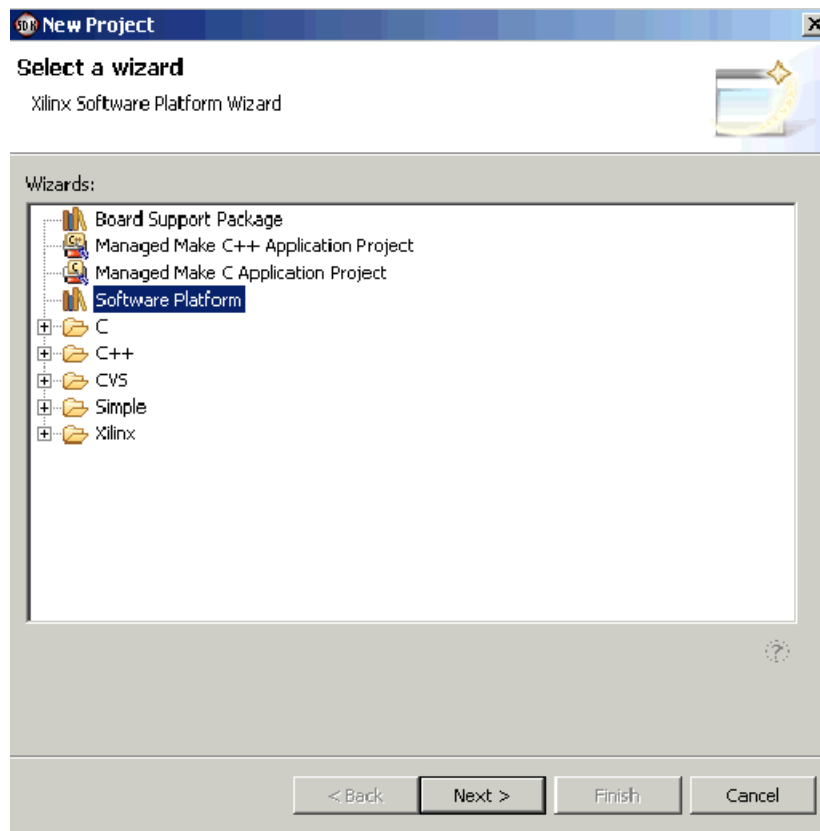

5. Enter the project name and click **Finish**

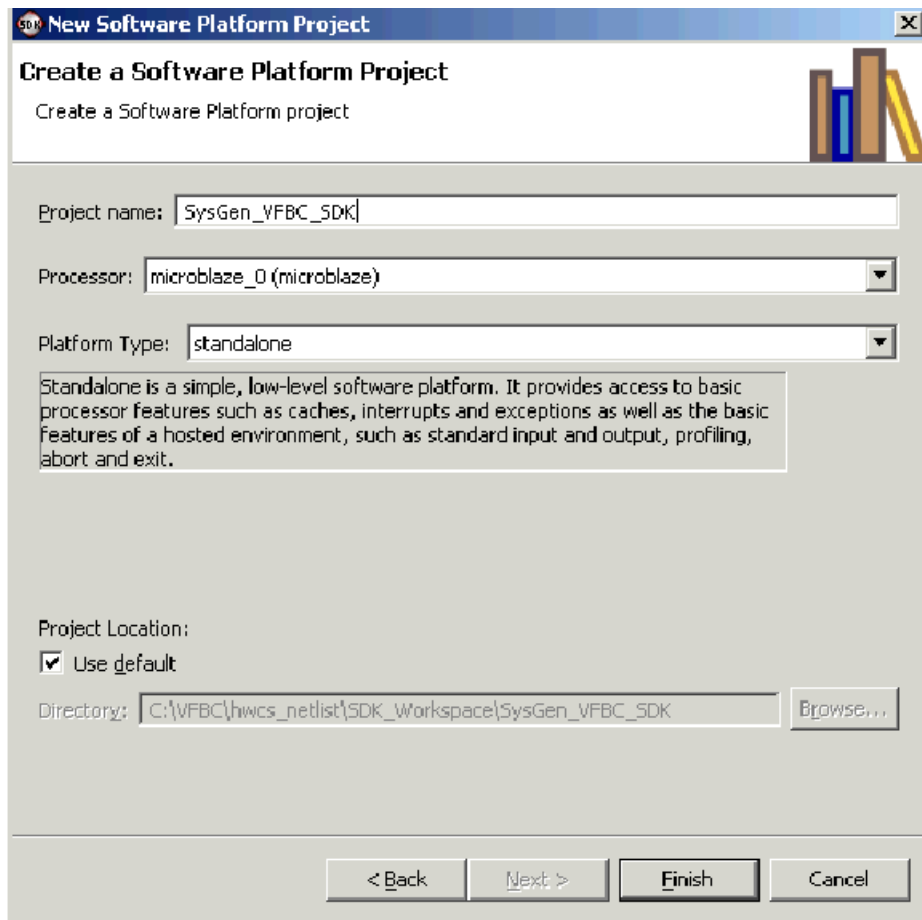

## 6. Right-click on SysGen\_VFBC &gt; New &gt; Manage Make C Application Project

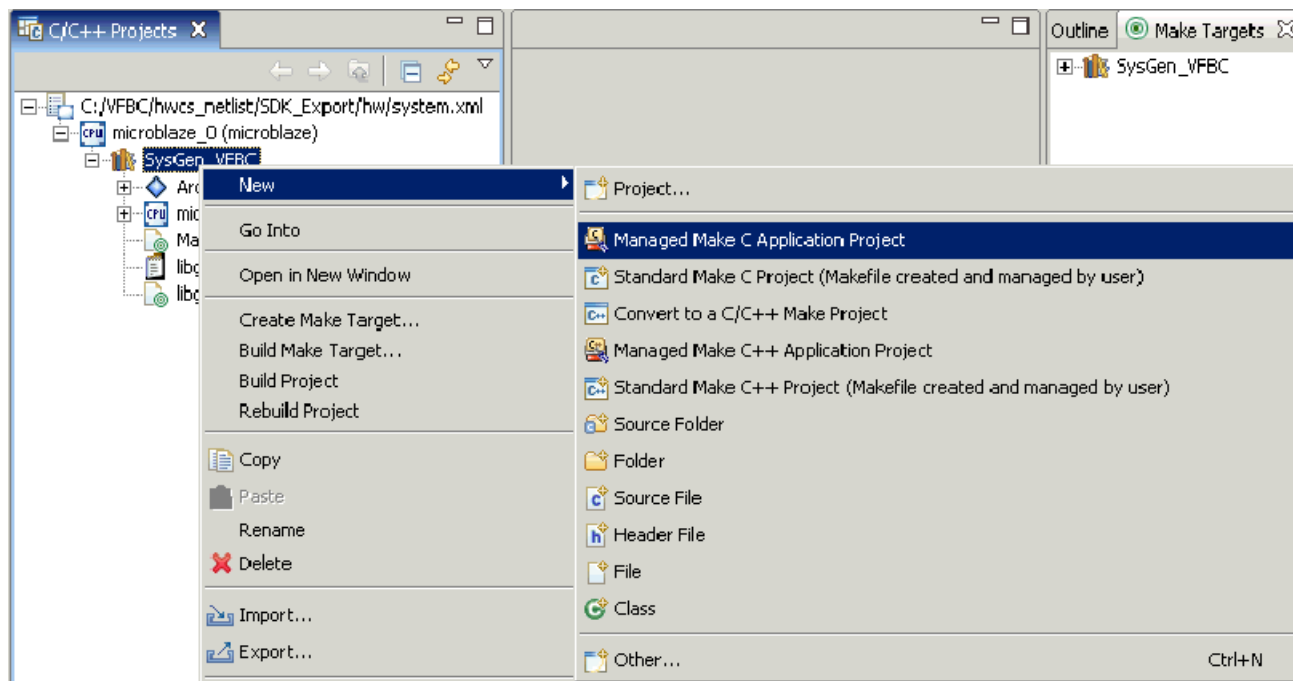



- Enter the Software Platform Project name, select **Empty Application** with no template and click **Finish**.

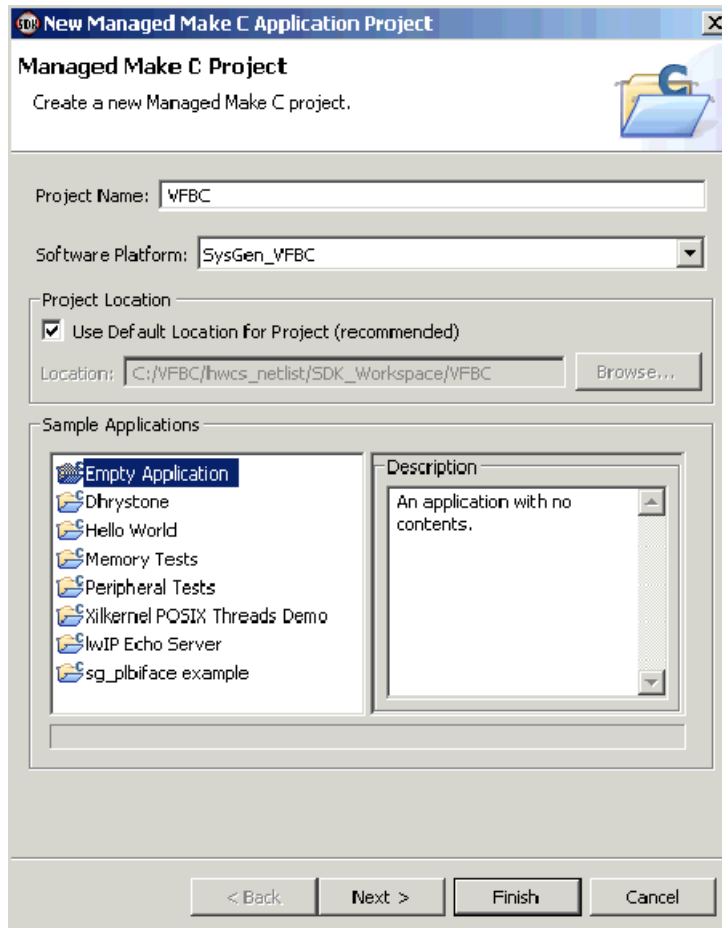

Your SDK design cockpit should look similar to the figure below.:

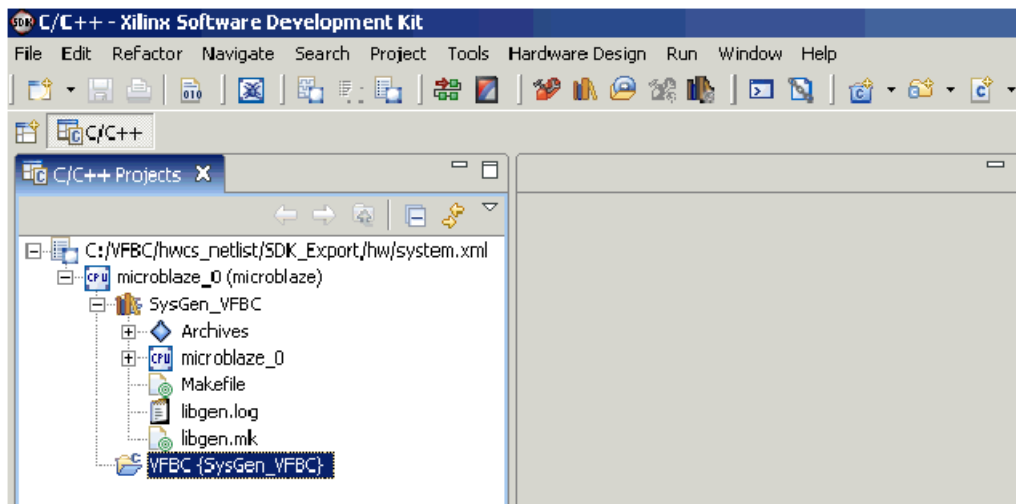

8. The last step is to either create a new C-code source file or add an existing one to the project. In this case, you can just add the existing one from C:\VFBC\C-code\vfbc.c. The easiest way to add a C-code source file to the VFBC {SysGen\_VFBC} application project is to simply Copy & Paste or Drag & Drop the file into the project. Once the file is added, the project will be built and compiled automatically.

## How to Iterate the Design between System Generator and SDK

By default, the ELF file is named after the application project name – VFBC.elf in this case. It's also located under the folder of the application project location.

Design iteration using the SDK is similar to that performed in XPS but with more advanced features and functionality. Once the C-code is modified and saved, the software application is rebuilt and recompiled automatically. This, in turn, generates a new ELF file that is then be used by System Generator to recompile and update the bitstream to the target platform.

### Software Iteration

1. SDK -- Modify C-code and make sure the software project is recompiled successfully
2. Sysgen – Simulate the design

### Hardware Iteration

1. SDK – Add new peripherals or modify existing ones
2. Sysgen – Re-import an XPS project into the Sysgen design
3. Sysgen – Re-generate a Hardware Co-Simulation block
4. SDK – Modify C-code accordingly
5. Sysgen – Re-simulate the design

**Note:** Making Hardware changes requires a new design implementation through Place & Route.

## Tutorial Example - Using System Generator and SDK to Co-Debug an Embedded DSP Design

### Introduction

Xilinx ISE Design Suite includes a new beta feature that introduces key improvements in the integration flow between System Generator, Xilinx Platform Studio (XPS), and Software Development Kit (SDK). These improvements concentrate on the following areas:

1. Enables you to rapidly import a test MicroBlaze processor subsystem into System Generator and simulated through hardware co-simulation in order to debug a DSP circuit under development
2. Perform co-debugging with System Generator and SDK together

The majority of this tutorial exercise is focused on the use-case where you import an XPS design into System Generator. This flow allows you to debug your DSP design in System Generator with real live data generated from the MicroBlaze. System Generator's Hardware Co-Simulation technology allows the MicroBlaze to be running in hardware and for the rest of the DSP design to be simulated (in software) in System Generator. This gives you visibility into all the signals of the DSP design and is useful for finding hardware and interface/protocol bugs.

The following are some of benefits of using Co-Debug between System Generator and SDK:

- Concurrent visibility of software and hardware for debug
  - ◆ Set a breakpoint and debug while the MicroBlaze and hardware are stopped
  - ◆ Signals to probe do not need to be chosen before the bit stream is generated
- Find a bug, modify the C code, recompile and update the bitstream in seconds.
  - ◆ No need to rerun synthesis and the implementation flow when the software changes
  - ◆ The initial software program (ELF file) is automatically updated to the download bitstream. You no longer need to manually click the **Compile and update bitstream** button on the Hardware Co-Simulation block.
- Tight integration
  - ◆ The SDK project is automatically setup with the correct hardware platform
  - ◆ The required logic is automatically added to the design

## Objectives

After completing this tutorial exercise, you will be able to:

- Use shared memories in System Generator to interface DSP hardware with the MicroBlaze embedded processor
- In XPS, create a basic XPS project using the BSB Wizard
- In System Generator, import an XPS project into a Sysgen design
- In System Generator, generate a hardware co-simulation block and launch SDK directly from System Generator
- In SDK, co-debug a design by single-stepping and observing output waveforms on a Simulink scope

## Tutorial Exercise Setup

The following software is required to be installed on your system to successfully complete this exercise:

- Xilinx ISE Design Suite 14 (System Edition)
- MATLAB / Simulink R2011a or R2011b
- SP601 Platform
- JTAG Cables that come with the SP601 Platform

## Design Description

The System Generator design below includes a FIR Compiler 5.0 block with Shared Memory blocks – From / To FIFOs. Also included is an SP601 embedded system with a MicroBlaze processor, PLB4.6 bus, and a UART Lite peripheral, all created using the Platform Studio BSB (Base System Builder) Wizard.

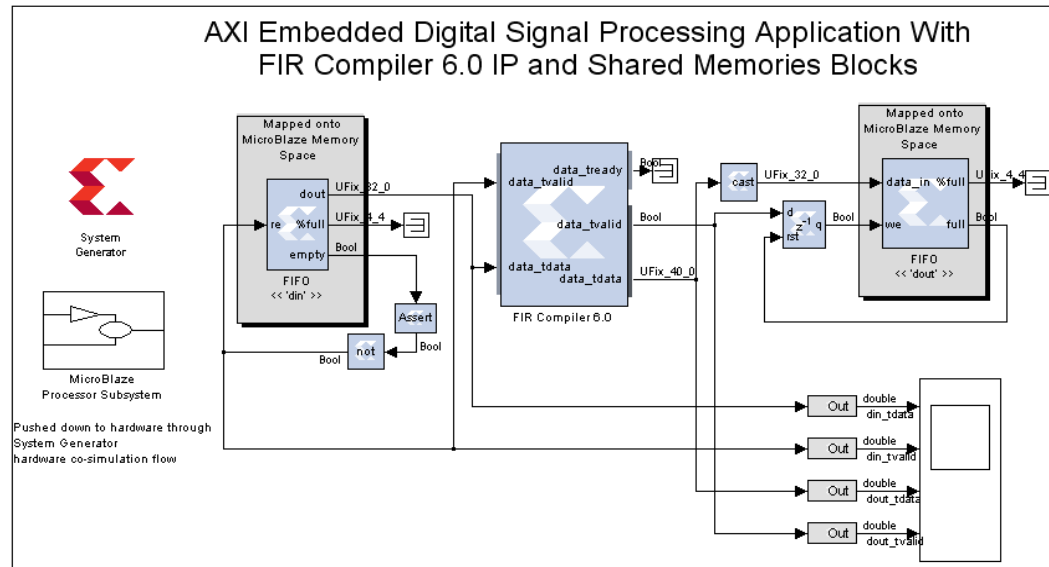

This simple design contains the following major components:

- **FIR Compiler 5.0:** a parameterizable FIR filter that accepts input data from the `din` pin.
- **MicroBlaze Processor Subsystem:** contains an SP601 embedded system with a MicroBlaze processor, PLB4.6 bus, and a UART Lite peripheral created using the Platform Studio BSB (Base System Builder) Wizard. This subsystem will be compiled into hardware using the System Generator hardware co-simulation design flow.
- **From FIFO `din` block:** is used to accept input data from the MicroBlaze processor and feed it to the input `din` of FIR Compiler. This input data is accessible via both Simulink and MicroBlaze during the co-debugging session.
- **To FIFO `dout` block:** is used to accept output data from the FIR Compiler `dout` and feed it to the MicroBlaze processor. This output data is also accessible via both Simulink and MicroBlaze during the co-debugging session.

The two design files for this exercise are located at the following pathname:

<ISE Design Suite\_tree>/sysgen/examples/SDK\_CoDebug

- ◆ **fir\_compiler\_mb.mdl** – A System Generator Simulink design model
- ◆ **axi\_sdk\_codebug\_example.c** or **plb\_sdk\_codebug\_example.c** – C code used to drive the DSP design from the Microblaze processor depending on which memory map type (AXI4 or PLB) you are using.

## PROCEDURE

In this procedure, you will follow four primary steps:

**Step 1** Familiarize yourself with the tool flow between System Generator and Platform Studio and how DSP and Embedded components can be integrated together

**Step 2** Create an embedded system that includes a MicroBlaze embedded processor using Xilinx Platform Studio (XPS)

**Step 3** Incorporate an XPS project into a System Generator design and generate a Hardware Co-Simulation block

**Step 4** Create a software application project and co-debug a System Generator design using an integrated flow between System Generator and SDK

### Step 1 Familiarize yourself with tool flow between System Generator and Xilinx Platform Studio

**Note:** You can skip this step and start with Step 2 if you are already familiar with Sysgen design flows. You can revisit these steps later if you like.

#### General Flow for this Exercise

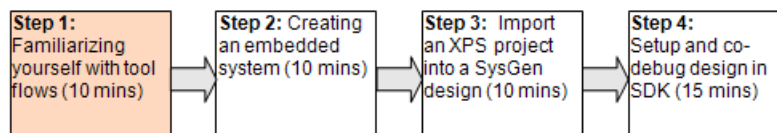

The figure above shows a typical Xilinx tool flow between IP, Project Navigator, Platform Studio, Software Development Kit and System Generator. Depending on your application, you may want to use different design methodologies when designing an Embedded DSP application. Sysgen provides two different approaches to integrating a MicroBlaze processor from Platform Studio with a System Generator design and they serve different purposes. It will be helpful to understand some of its basic differences between these two unique flows.

1. **EDK Export flow:** allows you to generate and export a Sysgen design model as a pcore to the MicroBlaze processor project. This flow works well if you want to integrate a System Generator design as a sub-level design to the MicroBlaze processor system. The typical steps to accomplish this design flow are described as follows:
  - ◆ Create a System Generator design model
  - ◆ Generate and export the System Generator model to an XPS project. The XPS project can be created using the Base System Builder Wizard. The System Generator pcore will appear in the XPS IP catalog.
  - ◆ Add and attach the System Generator pcore to an embedded MicroBlaze processor system

2. **EDK Import flow:** allows you to integrate a MicroBlaze processor system into a System Generator design as a sub-system. This flow is very useful especially if you want to bring the MicroBlaze processor system into the System Generator design environment for debugging and simulating purposes. You can take advantages of a very complex and powerful simulation platform – Simulink, HDL (including ModelSim and ISIM), and hardware simulations. The typical steps to accomplish this design flow can be described as follows:

- ◆ Create an XPS project using the Base System Builder Wizard
- ◆ Create a System Generator design model
- ◆ Import the XPS project into a System Generator design by using the EDK Processor block
- ◆ Depending on your needs, you can either perform hardware co-simulation for debugging or validating your hardware platform or add the netlist into a bigger design

**Note:** The obvious advantage with this flow is the ability to perform the hardware co-simulation on the processor block and its peripherals and take advantages of the rich and powerful Simulink simulation and debugging capability.

3. **System Generator Dual Clock Support for EDK Processors:** System Generator supports dual clock wiring, which means that the imported processor system and the other portion of a System Generator model are driven by two independent clock domains. One major benefit with dual clock wiring is that the MicroBlaze processor system and the System Generator user logic can run at different clock frequencies. For example, MicroBlaze can comfortably operate at 100 MHz, while a DSP FIR (finite impulse response) filter in System Generator can run at up to 400 MHz.

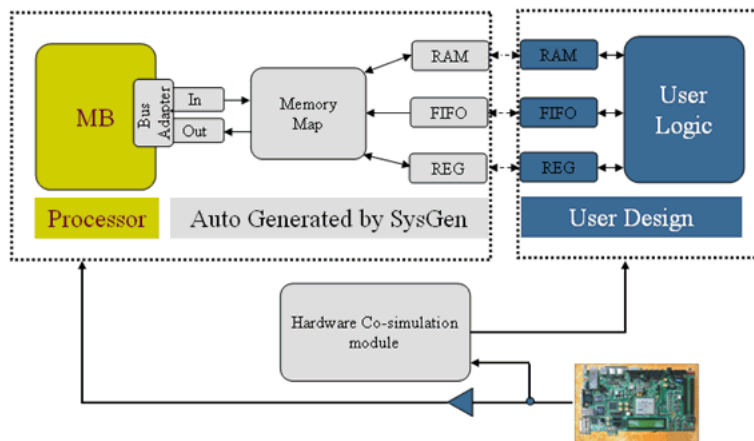

**Hardware Co-simulation with Dual Clock Wiring**

## Step 2 Generating the BSB System Using the XPS BSB Wizard

### General Flow for this Exercise

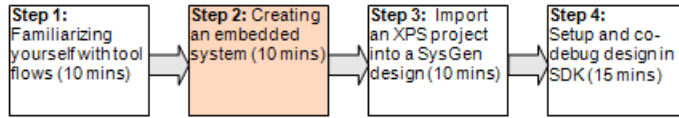

1. Create a sub-folder in the SDK\_CoDebug examples folder named “XPS”
1. Select **Start > All Programs > Xilinx Tools > ISE Design Suite 14 > EDK > Xilinx Platform Studio** or double-click the Xilinx Platform Studio shortcut on the desktop if available
2. Select **File > New Project**
3. Select Base System Builder wizard and click **OK**

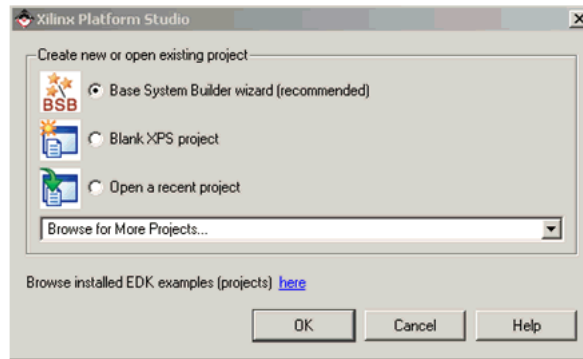

4. Specify an XPS project name, located in the **SDK\_CoDebug/XPS** folder and click **OK**.

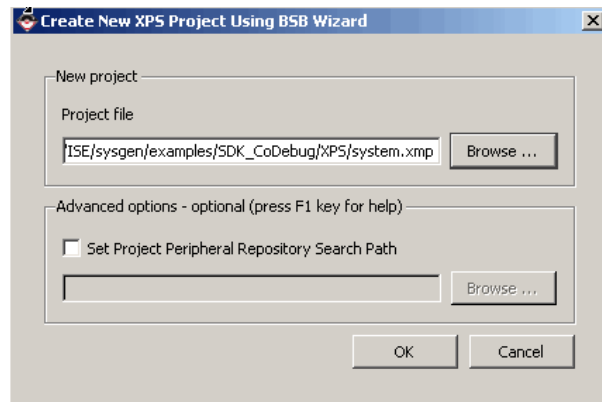

5. Click **Next**

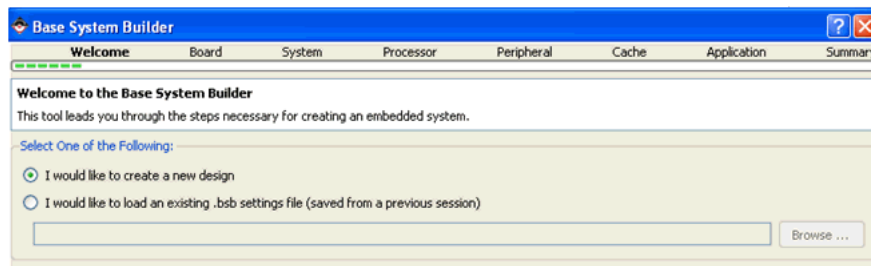

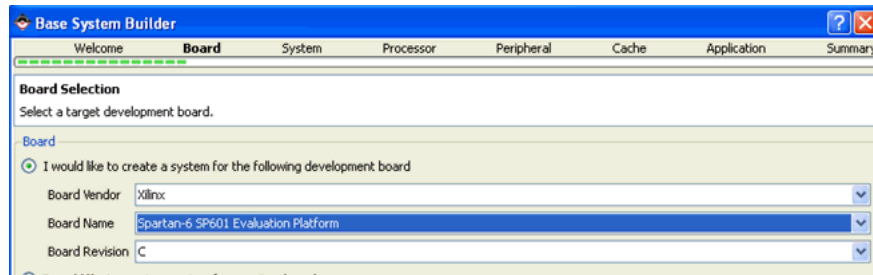
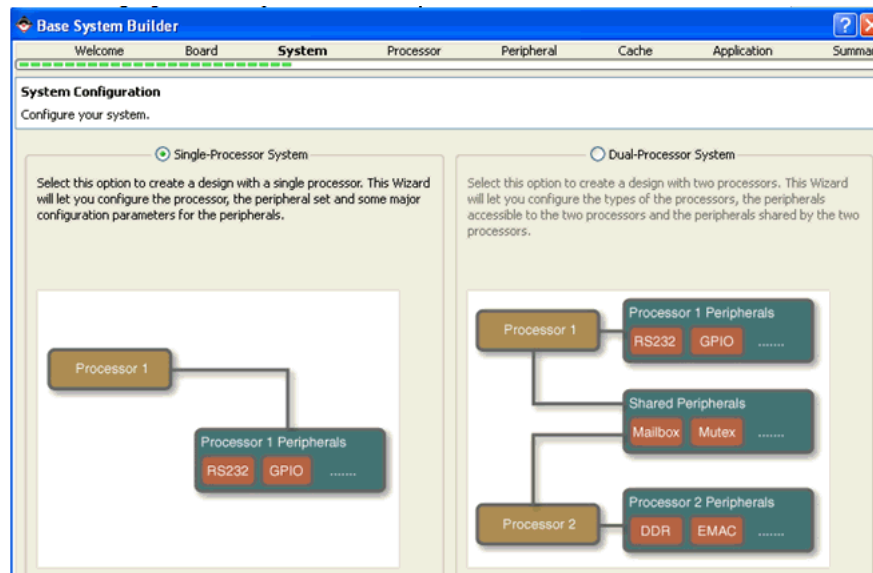
6. Select the **Spartan-6 SP601 Evaluation Platform** and click Next7. Select a **Single-Processor System** and click Next

## 8. Change "Local Memory" to 32 KB and click Next

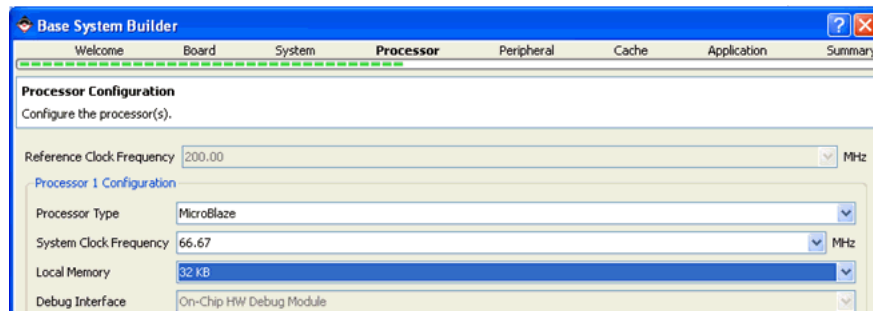



- Use the **Remove** button to remove unused **IO Devices** and **Internal Peripherals** under **Processor 1** at the right-hand side of the screen and only keep **RS232\_Uart\_1**, **dlmb\_cntlr**, and **ilmb\_cntnr** as shown in the figure below. Click **Next**.

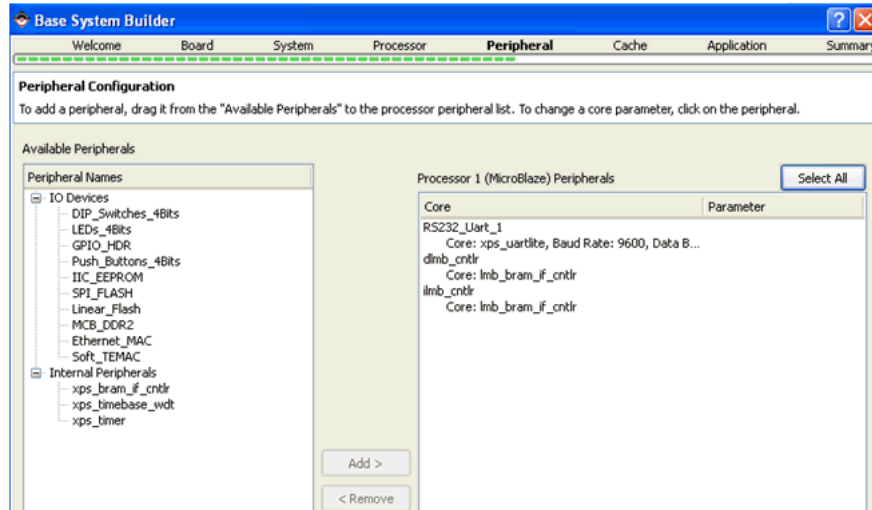

- Click **Next** in the **Cache configuration** screen and press OK on Timing closure Warning.
- Click **Next** in the **Application configuration** screen
- Click **Finish** in the **Summary** screen
- Click **OK** in **The Next Step** screen and close the XPS application

### Step 3 Import the Embedded System into the Sysgen Design and Generate a Hardware Co-Simulation Block

#### General Flow for this Exercise

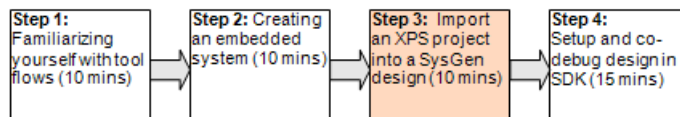

You have just completed the process of creating and configuring an embedded system for a Xilinx FPGA. This embedded system is now ready to be incorporated into a Sysgen design – **fir\_example\_mb.mdl**

- Switch to Sysgen and open the file **fir\_example\_mb.mdl**

**Note:** This may take up to 3 minutes the first time since Sysgen will call PartGen in order to populate the devices in the Sysgen token.

**Note:** Change the Simulink Solver on this model to 'ode45' or you will get the following warning:

*Warning: The model 'fir\_example\_mb' does not have continuous states, hence Simulink is using the solver 'VariableStepDiscrete' instead of solver 'ode45'*

- Double-click on the MicroBlaze Processor Subsystem to open down to a lower hierarchy

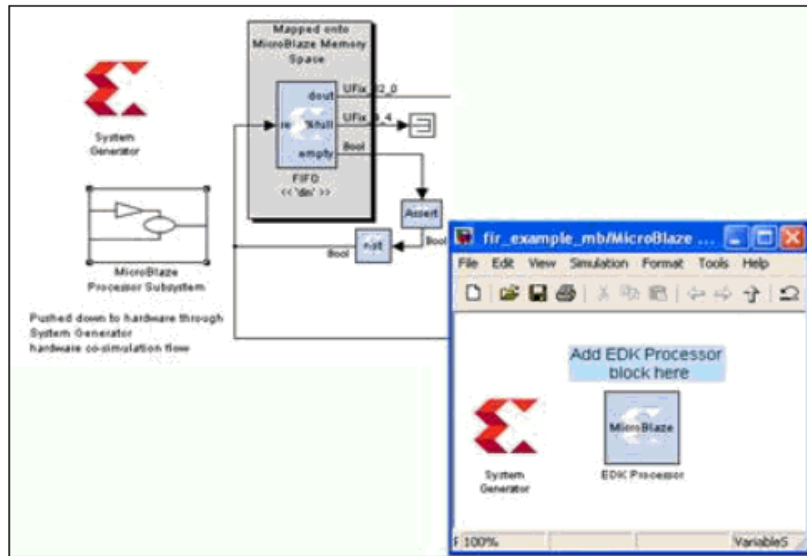

- Open the Simulink Library Browser, then open the Xilinx Blockset/Index folder. Select and Drag an EDK Processor block into the Subsystem sheet as shown above. Select the pulldown menu **File > Save** to save the sheet.
- Double-click on the **EDK Processor** block and click **Add** to map all available shared memory blocks and you should see the following shared memories:

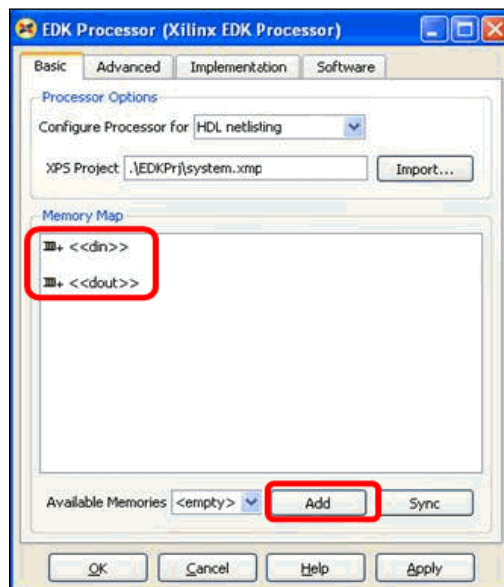

Click **Apply**, then proceed to the next step.

5. Select the **Implementation** tab and verify that the **Dual Clocks** options is selected. The **Bus Type** is automatically detected by System Generator.

**Note:** You will be using the Dual Clocks feature for this exercise. It enables System Generator and the imported XPS processor subsystem to operate in different asynchronous clock domains.

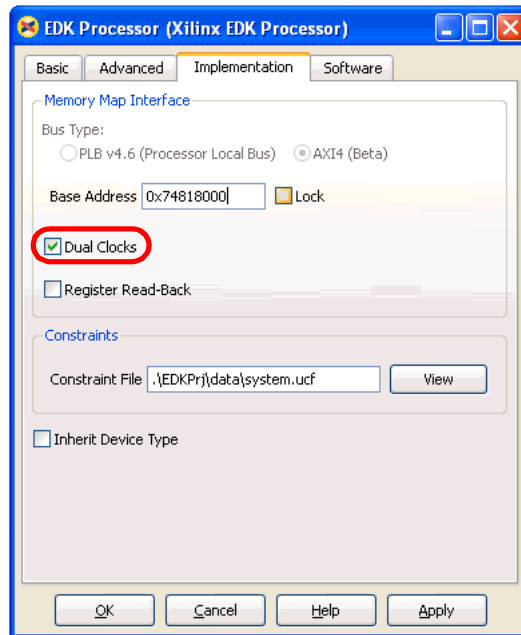

Click **Apply**, then proceed to the next step.

6. Select HDL netlisting in the Configure Processor for pull down menu. Click the **Import** button and use the **Import EDK project...** dialog box to select the XPS project that you just created in Step 2. The file is called system.xmp in the XPS directory.

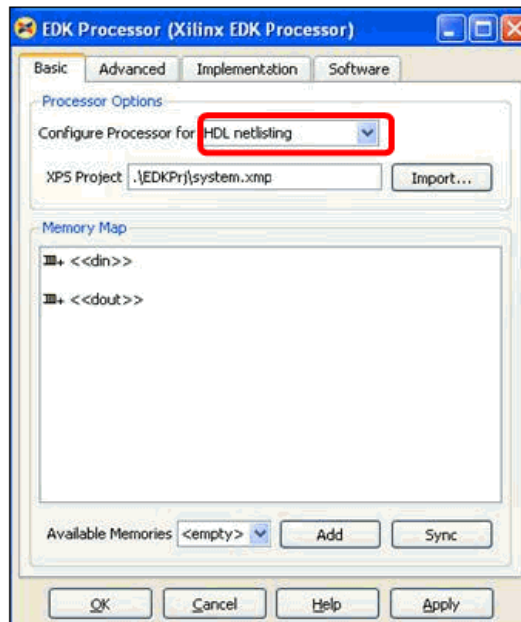

7. Click **Apply** and **OK** to close the dialog box. Save the design with the **File > Save** pulldown menu.
8. You are now ready to generate a hardware co-simulation block for this subsystem. Double-click on the Sysgen Token on this Subsystem and set its parameters as shown below.

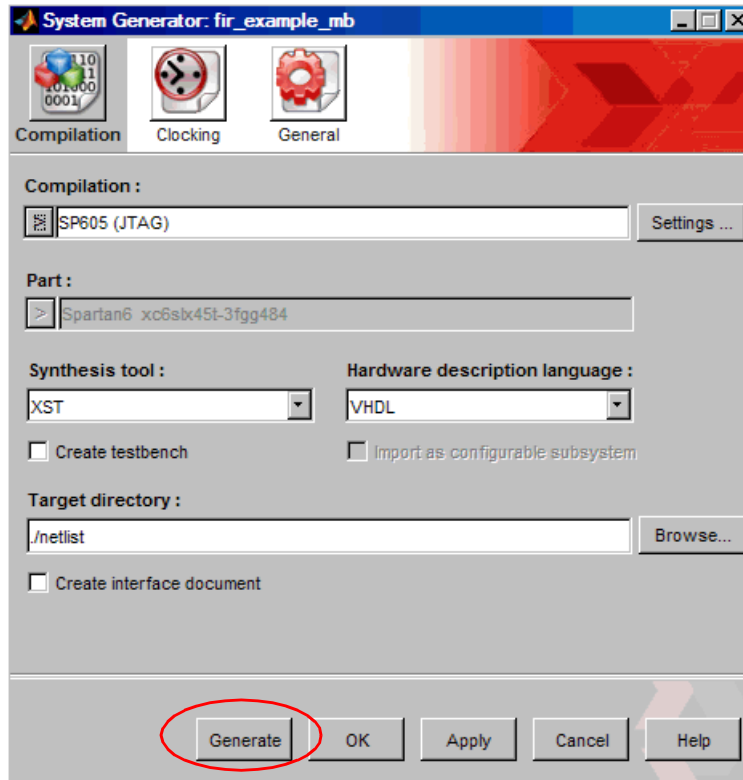

9. Click the **Generate** button to start generating a Hardware Co-Simulation block. This may take a few minutes.

#### Step 4 Create a Software Application Project and Co-Debug the Sysgen Design Using an Integrated Design Flow between Sysgen and SDK

##### General Flow for this Exercise

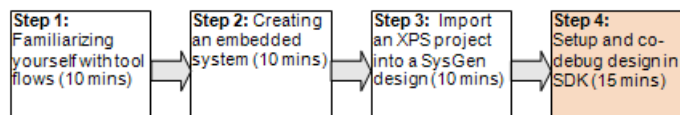

Importing an XPS design into System Generator allows you to co-debug your DSP design in SDK with real live data generated from the MicroBlaze while observing signals on the Simulink model. System Generator's Hardware Co-Simulation technology allows the MicroBlaze to be running in hardware and for the rest of the DSP design to be simulated (in software) in System Generator. This gives you visibility into all the signals of the DSP design and is useful for finding hardware and interface/protocol bugs.

In this section of the exercise, you will co-debug a System Generator design using SDK and System Generator. This will involve single-stepping the C-code and observing expected output signals inside the SDK console as well as on the waveform Scope of the Simulink

model. This co-debug methodology enables you to examine and verify signal values at different points in the C-code and Simulink signals.

1. Delete the Subsystem block from the `fir_example_mb.mdl` model as shown below:

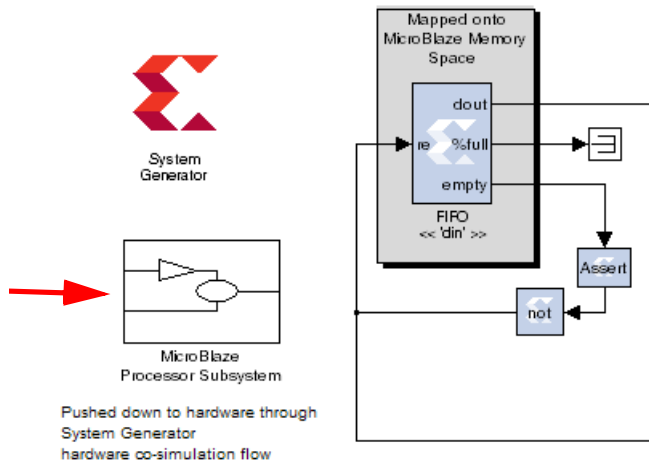

2. Now you will replace it with the hardware co-simulation block you just generated. Open the file `...netlist\Subsystem_hwcosim_lib.mdl`. then copy and paste the generated hwcosim block into the model as shown in the figure below.

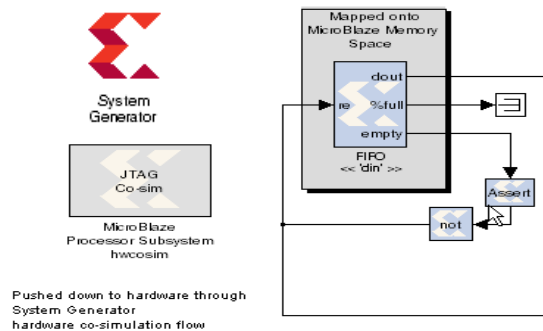

3. Save the model `fir_example_mb.mdl` as `fir_example_mb_hwcs.mdl`

4. Double click on the Subsystem hwcosim block and configure the block as follows:
  - **Basic Tab:** select Free running

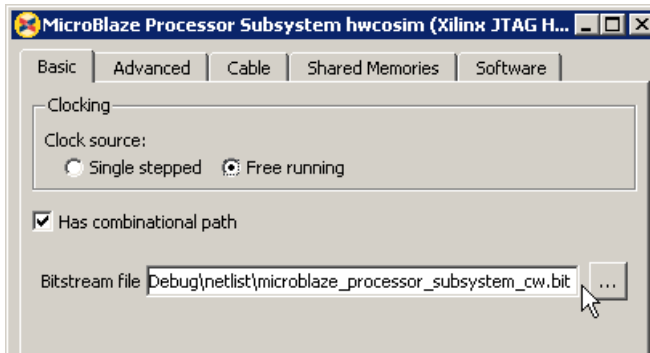

- **Cable Tab:** select Xilinx Platform USE

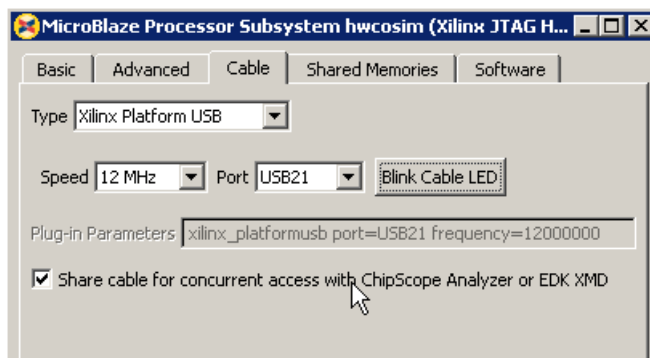

**Note:** Verify that the **Share cable for concurrent access with:** checkbox is selected

- **Shared Memories tab:**

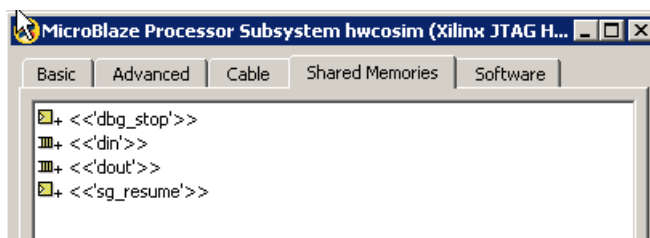

- **Software tab:**

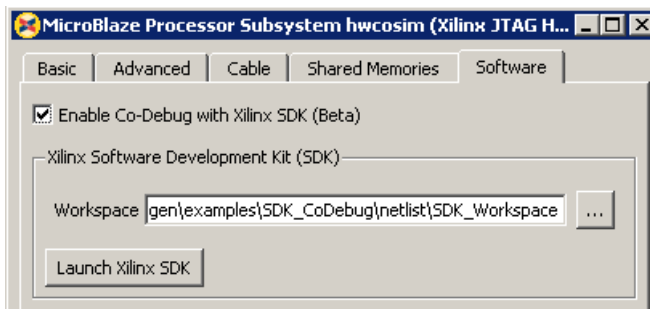

5. Click the Launch Xilinx SDK button, as shown in the figure above to launch SDK.

**Note:** When SDK is launched directly from System Generator, the target hardware platform should already be associated for you as shown by the figure below:

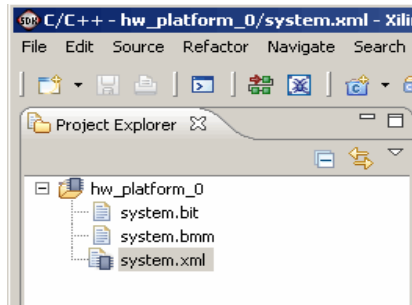

**Note:** You can also choose launch SDK independently and associate the SDK project with a hardware co-sim design using the following procedure:

- a. Launch SDK from the Windows Desktop
- b. Specify the SDK\_Working directory associated with the Sysgen design

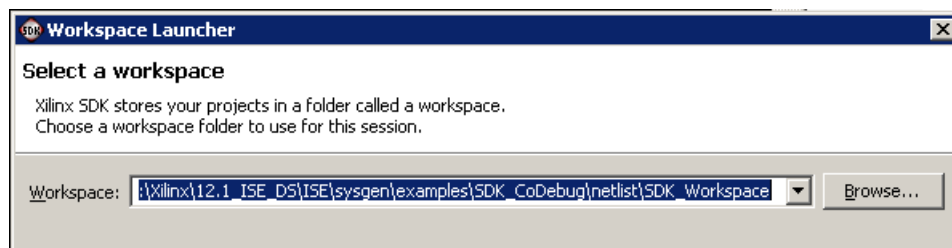

- c. From the SDK pulldown menu, select **Xilinx Tools > System Generator Co-Debug Settings**

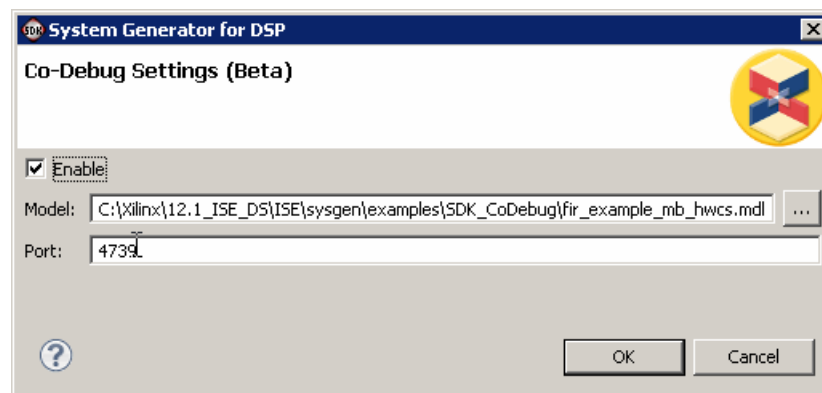

- d. Enter the pathname to the associated Hardware Co-Simulation model. You can use the default Port specification 4739.

- Continuing from step 5, create a new Xilinx C Project: **File > New > Xilinx C Project > Hello World (default project template)**

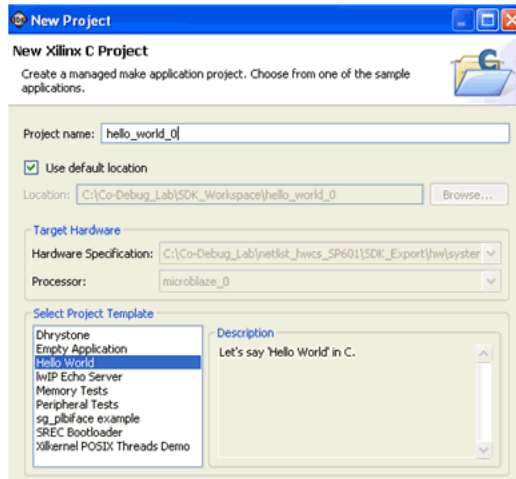

- Click **Next** and **Finish**

**Note:** At this point, both the Xilinx C application and Xilinx Software Platform should have already been created for you. (In the previous version of SDK, you would have to manually create each step separately.)

- The next task is to develop C-code to interface with the System Generator pcore. The default file **helloworld.c** is created for you and it can be used as your starting point. For your convenience, a complete C-code source file is provided for you named **sg\_hello\_world.c** and is located in the SDK\_CoDebug folder.
- Under the “hello\_world\_0” C application, within the src folder, delete the **helloworld.c** and replace it with the **...sg\_hello\_world.c**. The easiest way to add a new C-code file is to simply drag and drop it from **Windows Explorer** into the **src** directory.

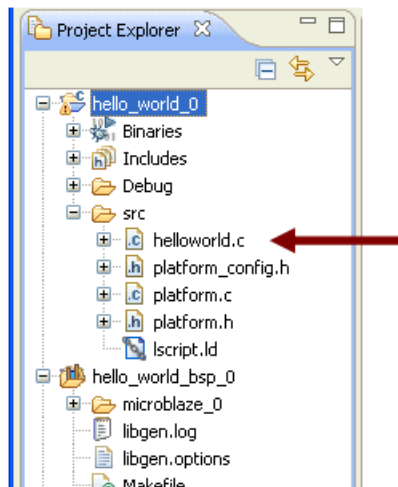



**Note:** Notice that the new C-code is automatically detected and compiled. If there is no syntax error and everything goes well, you should see a screen-shot similar to the one shown below.

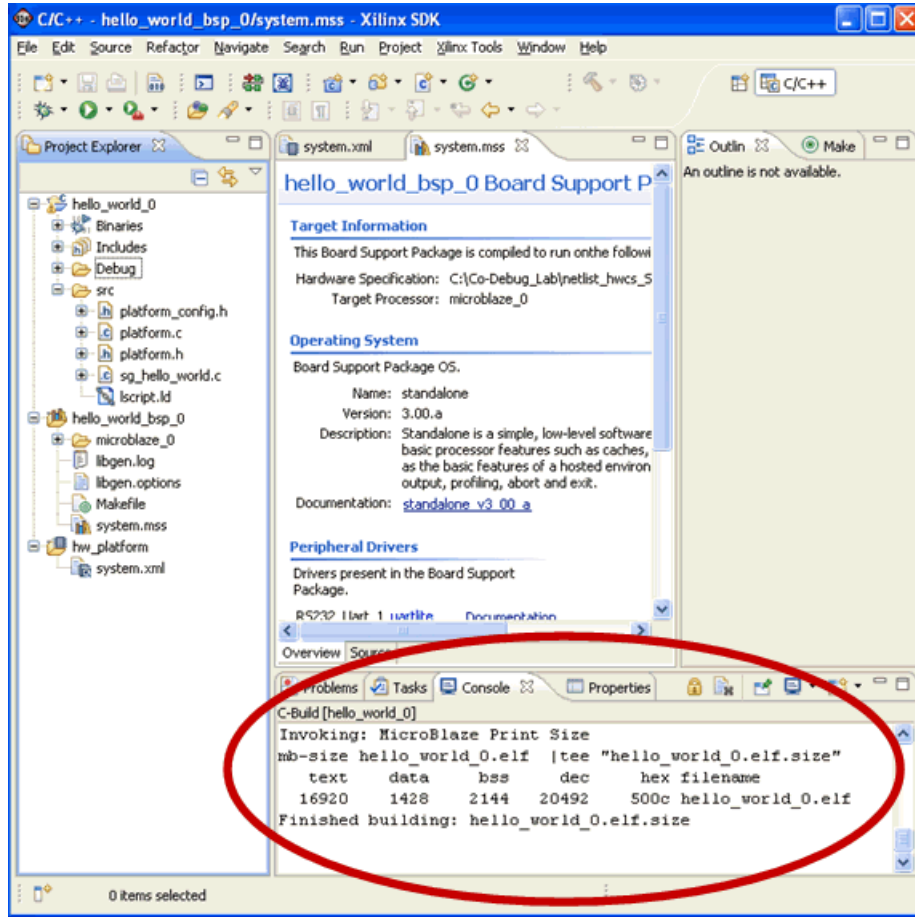

10. Before you start debugging your design, you may need to make sure that the COM port setting in SDK STUDIO is the same with what is being set on your PC.

Verify the COM port setting on your PC as follows:

- a. Right-click on **My Computer > Manage**, then click on **Device Manager**.
- b. Expand the **Ports (COM & LPT)** entry

- c. View the **Silicon Labs CP210x USB toUART Bridge** entry. The COM port assignment appears in parenthesis at the end of the line. In the case below, the port assignment is COM4.

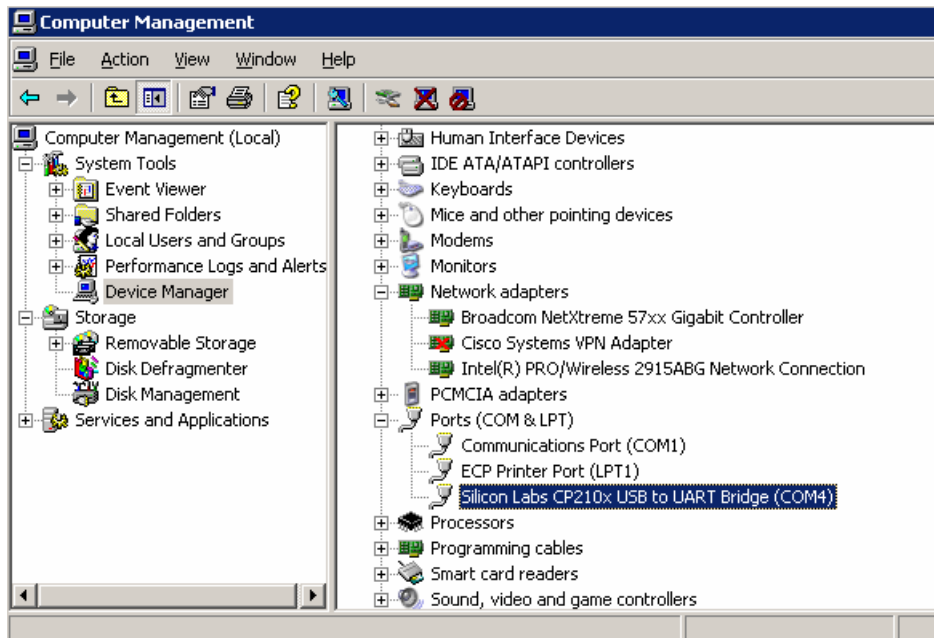

- d. If the port assignment is COM1, right-click on **Silicon Labs CP210x USB toUART Bridge (COM1)** and select **Properties**.
  - e. Click on the **Port Settings** tab and then click **Advanced**.
  - f. In the **COM Port Number** entry box, change the value from COM1 to any other unused port such as COM2.
  - g. Click OK to exit all open windows in this sub-procedure
11. There are a couple of ways to get to COM port settings from the SDK GUI. Here is one way:
    - a. Select the pulldown menu **Run > Run Configurations...**

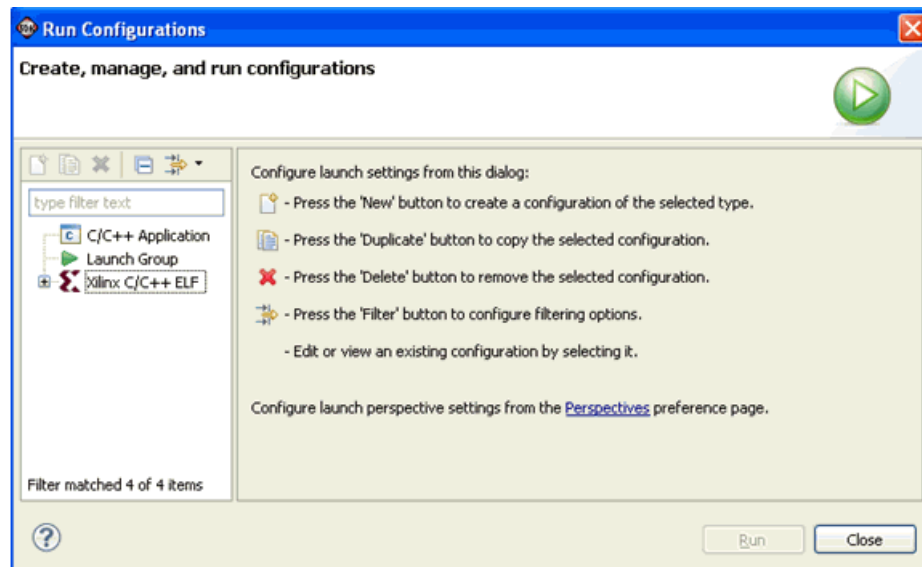

- b. Expand the **Xilinx C/C++ ELF** tree and select **hello\_world\_0 Configuration**. Configure the COM port by clicking on the **STDIO Connection** tab and select the COM port and BAUD Rate to match your PC settings as shown by the figure below, then click **Apply**.

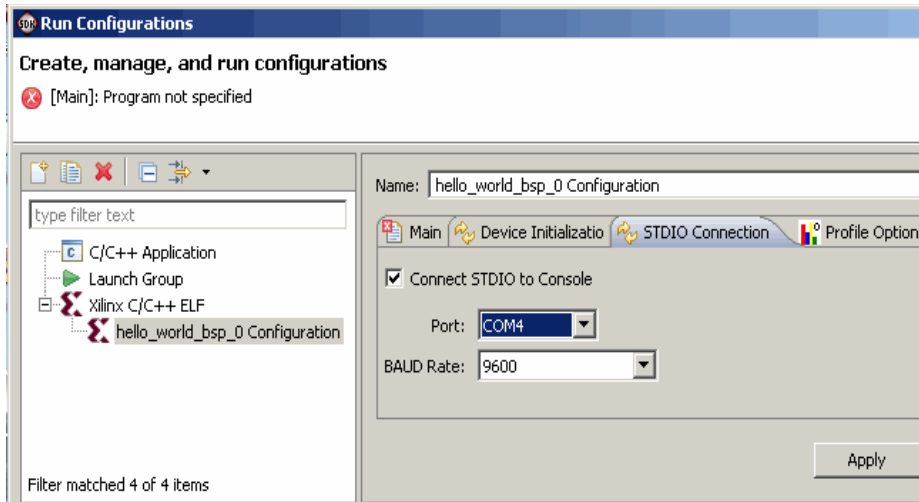

- c. Close the dialog box for now.

**Note:** Keep the following expected behavior in mind when debugging this simple Embedded DSP application.

- ◆ MicroBlaze creates a impulse signal that is transferred into the “din” FIFO shared memory.
  - ◆ This input impulse response is then propagated through the input din of the FIR Compiler IP with filter coefficients of 1~16.
  - ◆ The FIR Compiler outputs are then captured by the MicroBlaze via the “dout” FIFO shared memory. In this case the outputs are simply the filter coefficients, which are 1, 2, 3, 4...16.
12. Highlight the file **hello\_world\_0.elf** under the **Debug** folder and select the pulldown menu **Run > Debug** to initiate a debug session

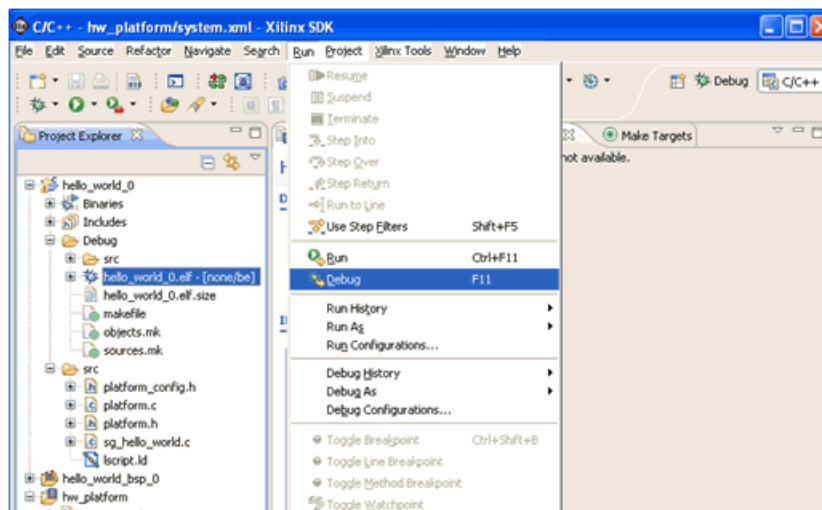

**Note:** Click **Yes** on the next screen

The tool should start downloading and configuring the bitstream through JTAG.

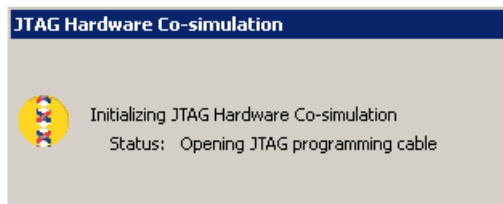

13. You may need to rearrange the Debug windows to display what you like to observe during the Debug session as shown in the following figure.
14. When you debug any application in the workspace for the first-time, CDT switches to "Debug Perspective" and prompts the user "if this should be the default behavior on debug?". Click on **Yes** to confirm this behavior.

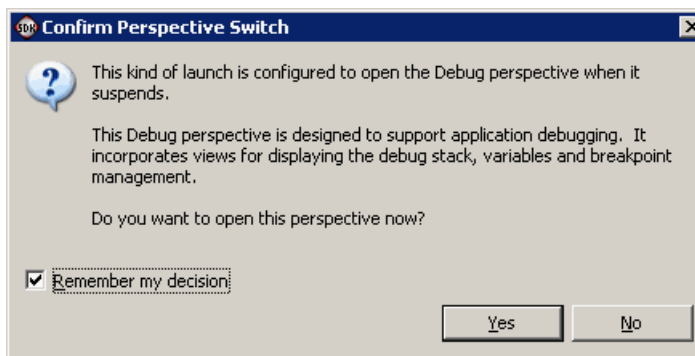

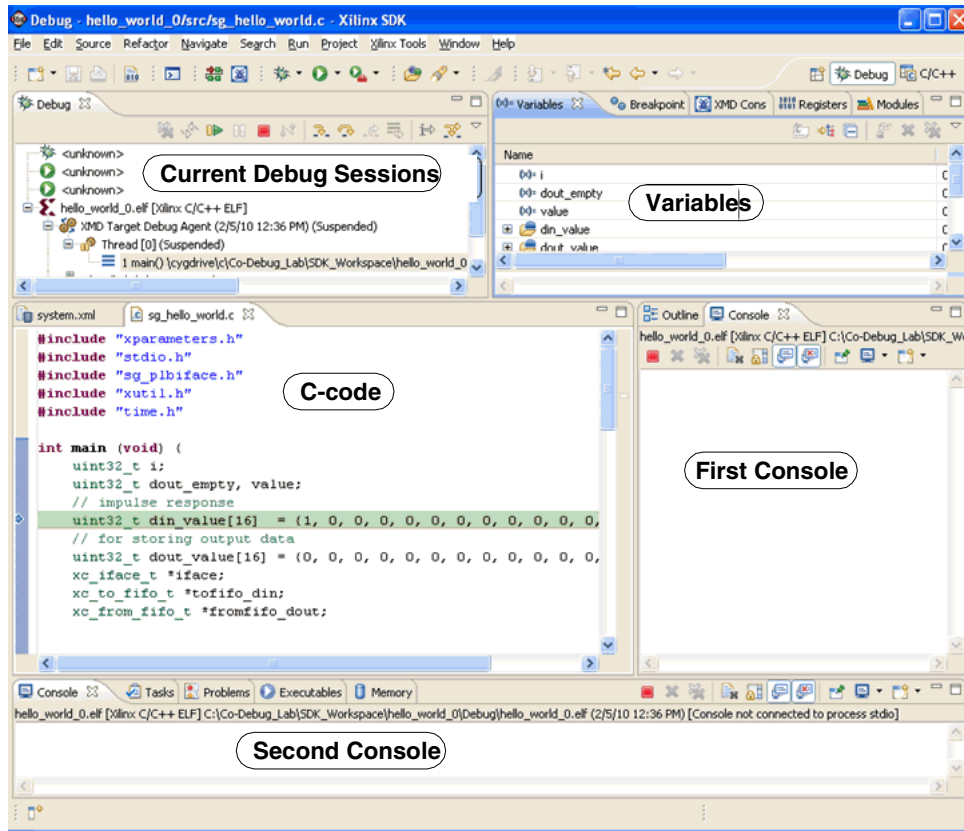

**Note:** Here are some of the nice features in this Debug cockpit that might be useful to you when debugging a design.

- ◆ You can hover on most of the variables in the C-code to display the values
- ◆ You don't have to bring up a separate HyperTerminal console. It's now being integrated inside the SDK GUI.
- ◆ The First Console is not available the first time you launch SDK but it can be added by using the New Console View as shown in the figure below.

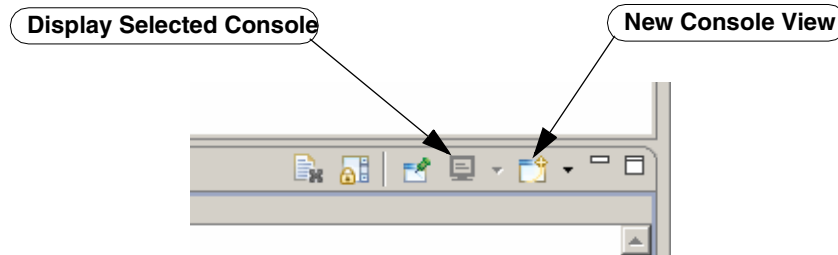

15. First, just download the bitstream and run the whole program without any breakpoints by clicking on the play button as shown below.

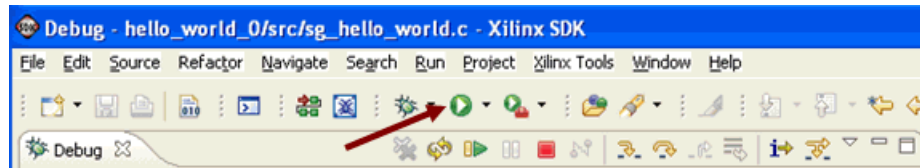

16. You should see the same results for the dout signal both on the SDK console and Simulink scope as shown below.

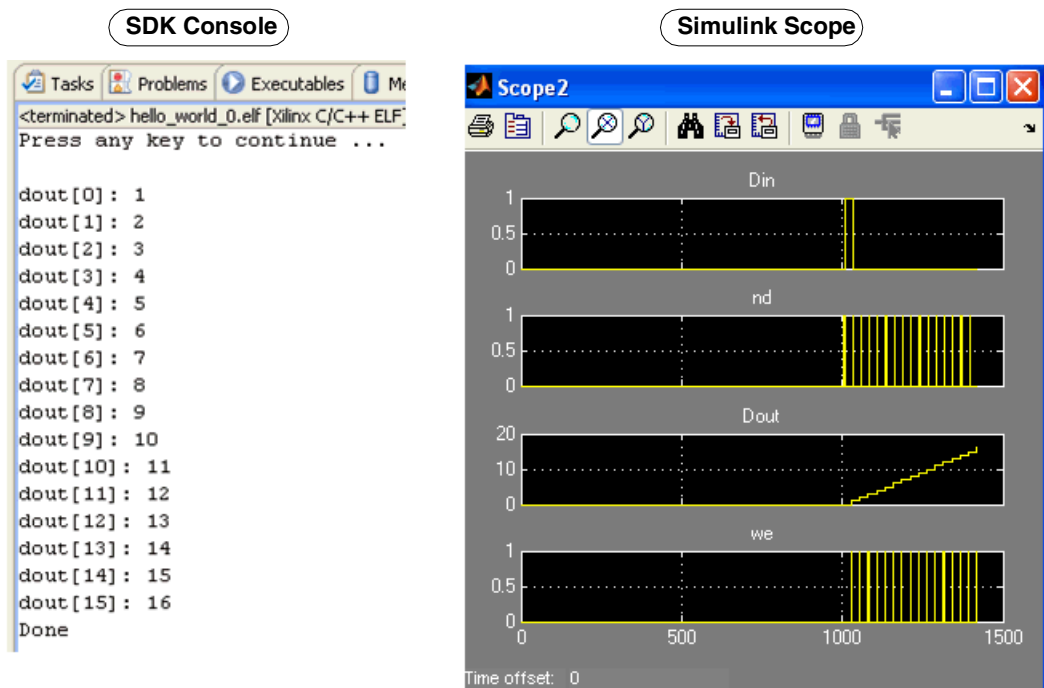

17. Place a breakpoint on line 55 of your C-code by double clicking on the line number. This will toggle the breakpoint off/on.

**Note:** You need to right click on the gray bar and select **Show Line Numbers** to display line numbers. When you first start SDK it does not show line numbers.

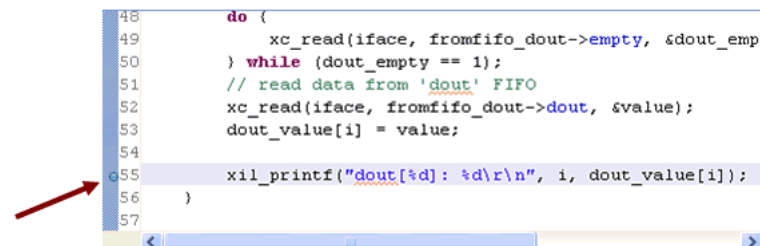

18. Instead of clicking on the play button, click on the **Debug** button as shown below.



19. Click on the **Resume** button (F8) to continue.

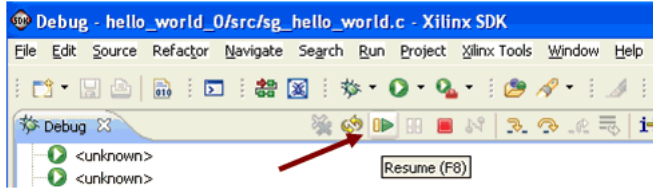

20. Again, place your mouse cursor into the open console and press any key to continue running the program.

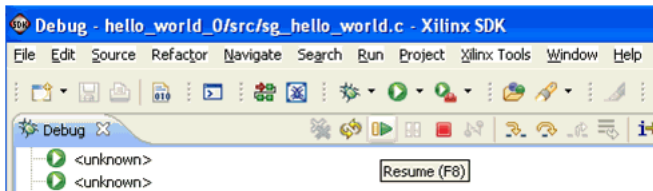

21. Continue clicking the **Resume** button and observe both the SDK console and Simulink Scope. You should see dout bit 0~16 being displayed as you step through the program. On the Simulink side, multiple signals are wired to the scope.

**Note:** Click on the **Autoscale** button to refresh the scope.

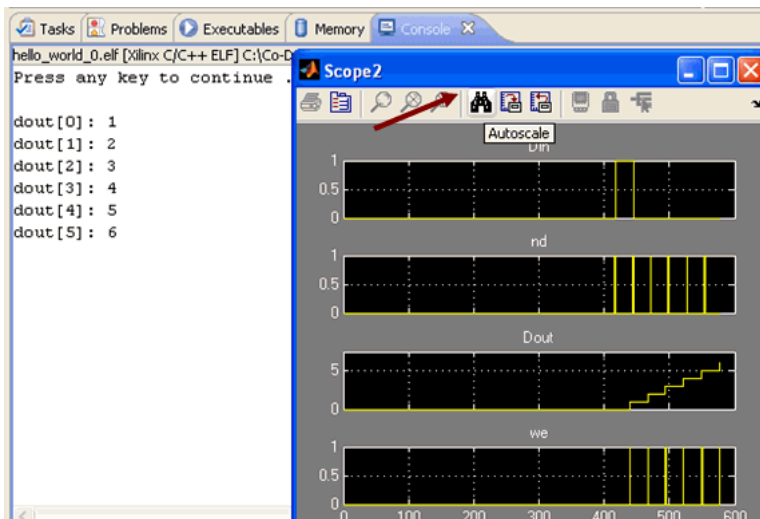

22. Next, terminate the current debug session and relaunch another one by right-clicking on the current application and select the **Terminate and Relaunch** submenu as shown below.

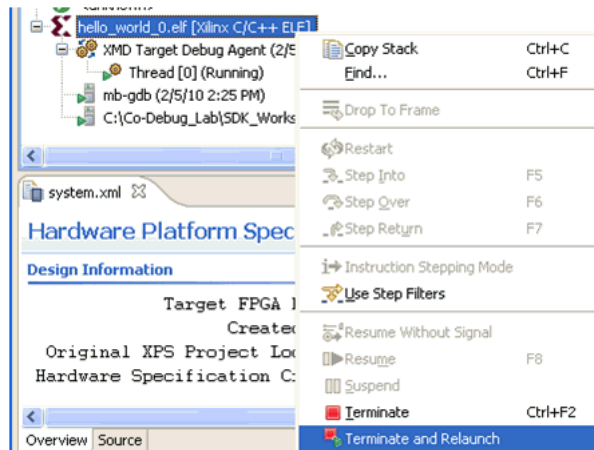

23. Another nice feature in SDK is an ability to examine and override variables. This is especially useful if you want to test for certain conditions of your C-code as well as your System Generator model. For example, if you want to test the While-loop by overriding the “i” variable, right-click on the “i” variable and change its current value to 16 (the last value).

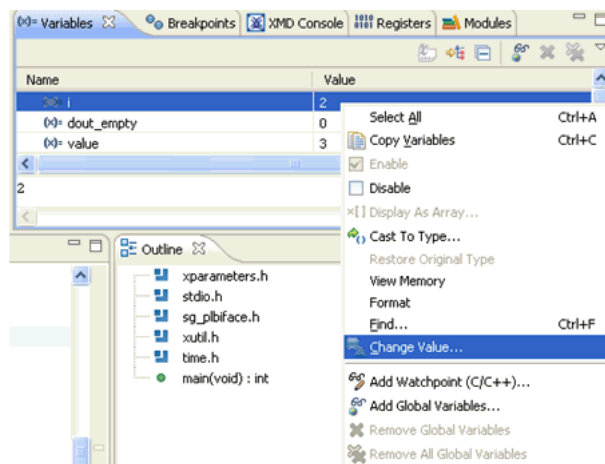

24. Click the **Resume** button and you should see “Done” printed out on the SDK console.



## Summary

The following are some of advantages of using Co-Debug between System Generator and SDK:

- You can debug software running in MicroBlaze as you normally do (insert breakpoints, single step, etc..) while observing how data is being transferred to/from a System Generator design
- You can develop and debug hardware and software concurrently without having to recompile the bitstream
- The System Generator Co-Debug circuit is automatically inserted into the XPS design
- When SDK is launched from System Generator, the SDK project is automatically setup with the correct hardware platform
- SDK-System Generator-ModelSim tool integration is enabled. You can import HDL code into System Generator, simulate it using ModelSim while co-debugging through the improved System Generator and SDK integration



# Using Hardware Co-Simulation

---

## Introduction

System Generator provides hardware co-simulation, making it possible to incorporate a design running in an FPGA directly into a Simulink simulation. "Hardware Co-Simulation" compilation targets automatically create a bitstream and associate it to a block. When the design is simulated in Simulink, results for the compiled portion are calculated in hardware. This allows the compiled portion to be tested in actual hardware and can speed up simulation dramatically.

## M-Code Access to Hardware Co-Simulation

It is possible to programmatically control the hardware created through the System Generator hardware co-simulation flow using MATLAB M-code (M-Hwcosim). The M-Hwcosim interfaces allow for MATLAB objects that correspond to the hardware to be created in pure M-code, independent of the Simulink framework. These objects can then be used to read and write data into hardware. This capability is useful for providing a scripting interface to hardware co-simulation, allowing for the hardware to be used in a scripted test-bench or deployed as hardware acceleration in M-code.

For more information of this subject, refer to the topic [M-Code Access to Hardware Co-Simulation](#) in the section Programmatic Access.

## Installing Your Hardware Board

The first step in performing hardware co-simulation is to install and setup your hardware board. The following topics provide Specific installation and setup instructions for Xilinx supported boards:

### Ethernet-Based Hardware Co-Simulation

[Installing an ML402 Board for Ethernet Hardware Co-Simulation](#)

[Installing an ML506 Board for Ethernet Hardware Co-Simulation](#)

[Installing an ML605 Board for Ethernet Hardware Co-Simulation](#)

[Installing a Spartan-3A DSP 1800A Starter Board for Ethernet Hardware Co-Simulation](#)

[Installing a Spartan-3A DSP 3400A Board for Ethernet Hardware Co-Simulation](#)

[Installing an SP601/SP605 Board for Ethernet Hardware Co-Simulation](#)

**Note:** If installation instructions for your particular board are not provided here, please refer to the installation instructions that come with your board Kit.

## JTAG-Based Hardware Co-Simulation

[Installing an ML402 Board for JTAG Hardware Co-Simulation](#)

[Installing an ML605 Board for JTAG Hardware Co-Simulation](#)

[Installing an SP601/SP605 Board for JTAG Hardware Co-Simulation](#)

[Installing a KC705 Board for JTAG Hardware Co-Simulation](#)

## Third-Party Hardware Co-Simulation

As part of the Xilinx XtremeDSP™ Initiative, Xilinx works with distributors and many OEMs to provide a variety of DSP prototyping and development boards. Please refer to the following Xilinx web site page for more information on available board

[http://www.xilinx.com/products/boards\\_kits/index.htm](http://www.xilinx.com/products/boards_kits/index.htm)

## Compiling a Model for Hardware Co-Simulation

Once your hardware board is installed, the starting point for hardware co-simulation is the System Generator model or subsystem you would like to run in hardware. A model can be co-simulated, provided it meets the requirements of the underlying hardware board. This model must include a System Generator token; this block defines how the model should be compiled into hardware. The first step in the flow is to open the System Generator token dialog box and select a compilation type under **Compilation**.

For information on how to use the System Generator token, see [Compiling and Simulating Using the System Generator Token](#).

### Choosing a Compilation Target

You may choose the hardware co-simulation board by selecting an appropriate compilation type in the System Generator token dialog box. Hardware co-simulation targets are organized under the **Hardware Co-Simulation** submenu in the **Compilation** dialog box field.

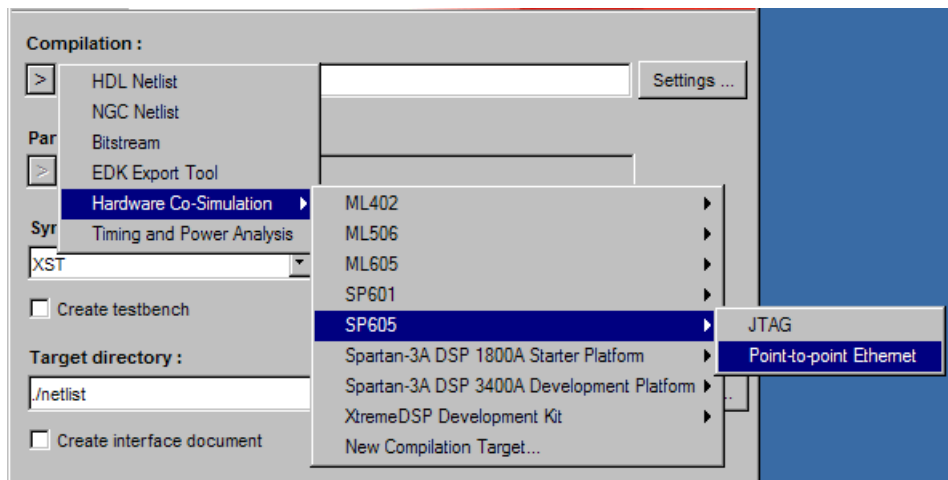

When a compilation target is selected, the fields on the System Generator token dialog box are automatically configured with settings appropriate for the selected compilation target. System Generator remembers the dialog box settings for each compilation target. These settings are saved when a new target is selected, and restored when the target is recalled.

### Invoking the Code Generator

The code generator is invoked by pressing the **Generate** button in the System Generator token dialog box.

The code generator produces a FPGA configuration bitstream for your design that is suitable for hardware co-simulation. System Generator not only generates the HDL and netlist files for your model during the compilation process, but it also runs the downstream tools necessary to produce an FPGA configuration file.

**Note:** A status dialog box (shown below) will appear after you press the **Generate** button. During compilation, the status box provides a **Cancel** and **Show Details** button. Pressing the **Cancel** button will stop compilation. Pressing the **Show Details** button exposes details about each phase of

compilation as it is run. It is possible to hide the compilation details by pressing the **Hide Details** button on the status dialog box.

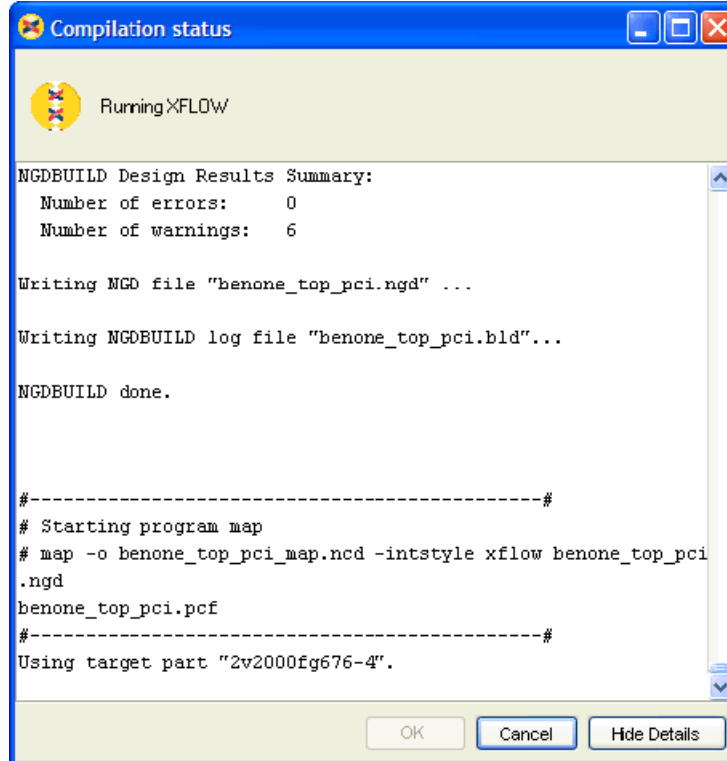

The configuration bitstream contains the hardware associated with your model, and also contains additional interfacing logic that allows System Generator to communicate with your design using a physical interface between the board and the PC. This logic includes a memory map interface over which System Generator can read and write values to the input and output ports on your design. It also includes any board-specific circuitry (e.g., DCMs, external component wiring) that is required for the target FPGA board to function correctly.

## Hardware Co-Simulation Blocks

System Generator automatically creates a new hardware co-simulation block once it has finished compiling your design into an FPGA bitstream. A Simulink library is also created in order to store the hardware co-simulation block. At this point, you can copy the block

out of the library and use it in your System Generator design as you would other Simulink and System Generator blocks.

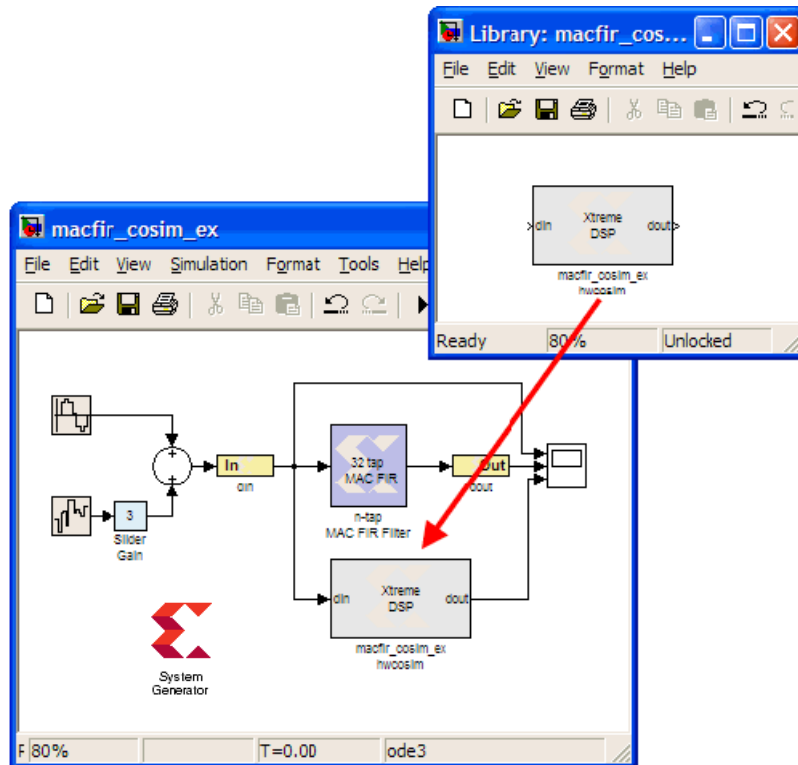

The hardware co-simulation block assumes the external interface of the model or subsystem from which it is derived. The port names on the hardware co-simulation block match the port names on the original subsystem. The port types and rates also match the original design.

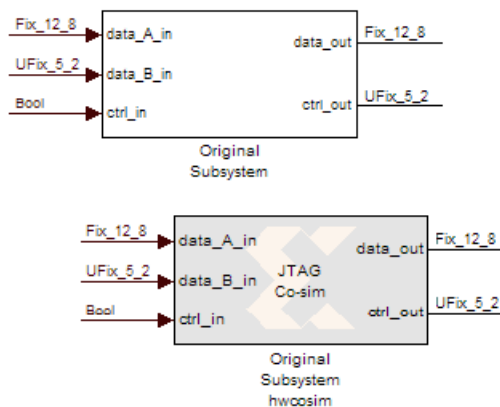

Hardware co-simulation blocks are used in a Simulink design the same way other blocks are used. During simulation, a hardware co-simulation block interacts with the underlying FPGA board, automating tasks such as device configuration, data transfers, and clocking. A hardware co-simulation block consumes and produces the same types of signals that

other System Generator blocks use. When a value is written to one of the block's input ports, the block sends the corresponding data to the appropriate location in hardware. Similarly, the block retrieves data from hardware when there is an event on an output port.

Hardware co-simulation blocks may be driven by Xilinx fixed-point signal types, Simulink fixed-point signal types, or Simulink doubles. Output ports assume a signal type that is appropriate for the block they drive. If an output port connects to a System Generator block, the output port produces a Xilinx fixed-point signal. Alternatively, the port produces a Simulink data type when the port drives a Simulink block directly.

**Note:** When Simulink data types are used as the block signal type, quantization of the input data is handled by rounding, and overflow is handled by saturation.

Like other System Generator blocks, hardware co-simulation blocks provide parameter dialog boxes that allow them to be configured with different settings. The parameters that a hardware co-simulation block provides depend on the FPGA board the block is implemented for (i.e., different FPGA boards provide their own customized hardware co-simulation blocks).



# Hardware Co-Simulation Clocking

## Selecting the Target Clock Frequency

If you are using a Xilinx ML402 or ML506 board, System Generator allows you to choose a clock frequency for the target design that is equal to or less than the system clock frequency. The following table outlines the frequencies that are available:

Board	Interface	System Clock Frequency	Available Frequencies
Xilinx ML402	JTAG, Point-to-point Ethernet, Network-based Ethernet	100 MHz	100 MHz 66.7 MHz 50 MHz 33.3 MHz
Xilinx ML506	Point-to-point Ethernet, Network-based Ethernet	200 MHz	100 MHz 66.7 MHz 50 MHz 33.3 MHz

As shown below, you set the target clock frequency at compilation time, by clicking the **Settings** button on the System Generator token dialog box, then select the frequency in the pulldown menu.

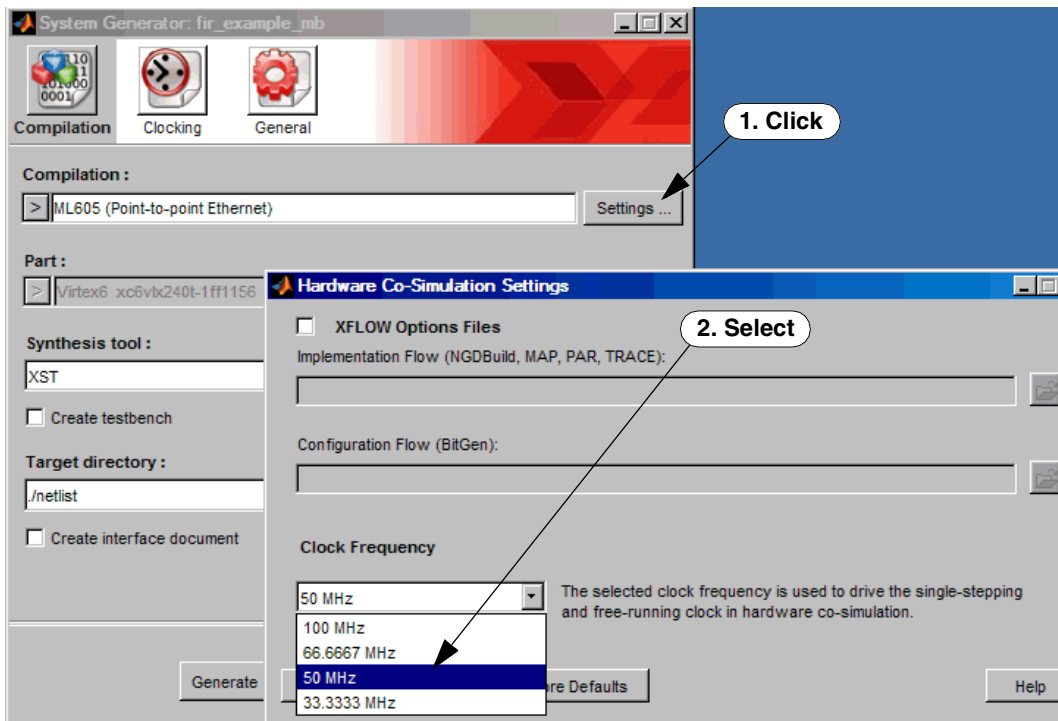

## Clocking Modes

There are several ways in which a System Generator hardware co-simulation block can be synchronized with its associated FPGA hardware. In single-step mode, the FPGA is in effect clocked from Simulink, whereas in free-running clock mode, the FPGA runs off an internal clock, and is sampled asynchronously when Simulink wakes up the hardware co-simulation block.

### Single-Step Clock

In single-step clock mode, the hardware is kept in lock step with the software simulation. This is achieved by providing a single clock pulse (or some number of clock pulses if the FPGA is over-clocked with respect to the input/output rates) to the hardware for each simulation cycle. In this mode, the hardware co-simulation block is bit-true and cycle-true to the original model.

Because the hardware co-simulation block is in effect producing the clock signal for the FPGA hardware only when Simulink awakes it, the overhead associated with the rest of the Simulink model's simulation, and the communication overhead (e.g. bus latency) between Simulink and the FPGA board can significantly limit the performance achieved by the hardware. As a general rule of thumb, as long as the amount of computation inside the FPGA is significant with respect to the communication overhead (e.g. the amount of logic is large, or the hardware is significantly over-clocked), the hardware will provide significant simulation speed-up.

### Free-Running Clock

In free-running clock mode, the hardware runs asynchronously relative to the software simulation. Unlike the single-step clock mode, where Simulink effectively generates the FPGA clock, in free-running mode, the hardware clock runs continuously inside the FPGA itself.

In this mode, simulation is not bit and cycle true to the original model, because Simulink is only sampling the internal state of the hardware at the times when Simulink awakes the hardware co-simulation block. The FPGA port I/O is no longer synchronized with events in Simulink. When an event occurs on a Simulink port, the value is either read from or written to the corresponding port in hardware at that time. However, since an unknown number of clock cycles have elapsed in hardware between port events, the current state of the hardware cannot be reconciled to the original System Generator model. For many streaming applications, this is in fact highly desirable, as it allows the FPGA to work at full speed, synchronizing only periodically to Simulink.

In free-running mode, you must build explicit synchronization mechanisms into the System Generator model. A simple example is a status register, exposed as an output port on the hardware co-simulation block, which is set in hardware when a condition is met. The rest of the System Generator model can poll the status register to determine the state of the hardware.

## Selecting the Clock Mode

Not every hardware board supports a free running clock. However, for those that do, the parameters dialog box for the hardware co-simulation block provides a means to select the desired clocking mode. You may change the co-simulation clocking mode before simulation starts by selecting either the **Single stepped** or **Free running** radio button under the **Clocking** etch box.

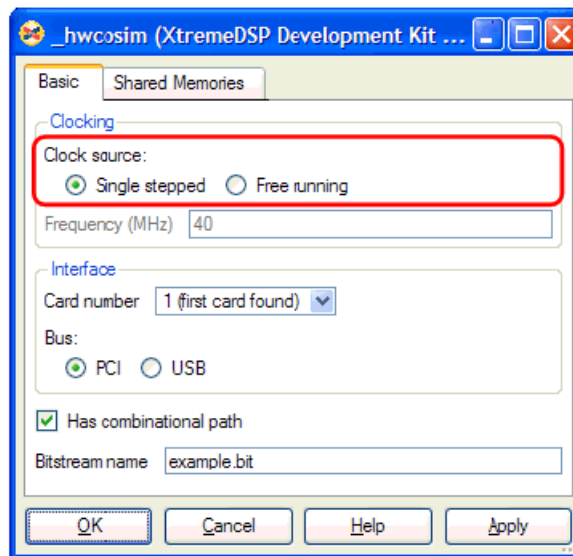

**Note:** The clocking options available to a hardware co-simulation block depend on the FPGA board being used (i.e., some boards may not support a free-running clock source, in which case it is not available as a dialog box parameter).

## Board-Specific I/O Ports

FPGA boards often include a variety of on-board devices (e.g., external memory, analog to digital converters, etc.) that the FPGA can communicate with. For a variety of reasons, it may be useful to form connections to these components in your System Generator models, and to use these components during hardware co-simulation. For example, if your board includes external memory, you may want to define the control and interface logic to this memory in your System Generator design, and use the physical memory during hardware co-simulation.

You can interface to these types of components by including board-specific I/O ports in your System Generator models. A board-specific port is a port that is wired to an FPGA pad when the model is compiled for hardware co-simulation. Note that this type of port differs from standard co-simulation ports that are controlled by a corresponding port on a hardware co-simulation block.

A board-specific I/O port is implemented using special *non-memory mapped gateway blocks* that tell System Generator to wire the signals to the appropriate FPGA pins when the model is compiled into hardware. To connect a System Generator signal to a board-specific port, connect the appropriate wire to the special gateway (in the same way as is done for a traditional gateway).

Non-memory mapped gateways that are common to a specific device are often packaged together in a Simulink subsystem or library. The XtremeDSP Development Kit, for example, provides a library of external device interface subsystems, including analog to digital converters, digital to analog converters, LEDs, and external memory. The interface subsystems are constructed using Gateways that specify board-specific port connections. These subsystems are treated like other System Generator subsystems during simulation (i.e., they perform double precision to Xilinx fixed-type conversions). When System

Generator compiles the design into hardware, it connects the signals that are associated with the Gateways to the appropriate external devices they signify in hardware.

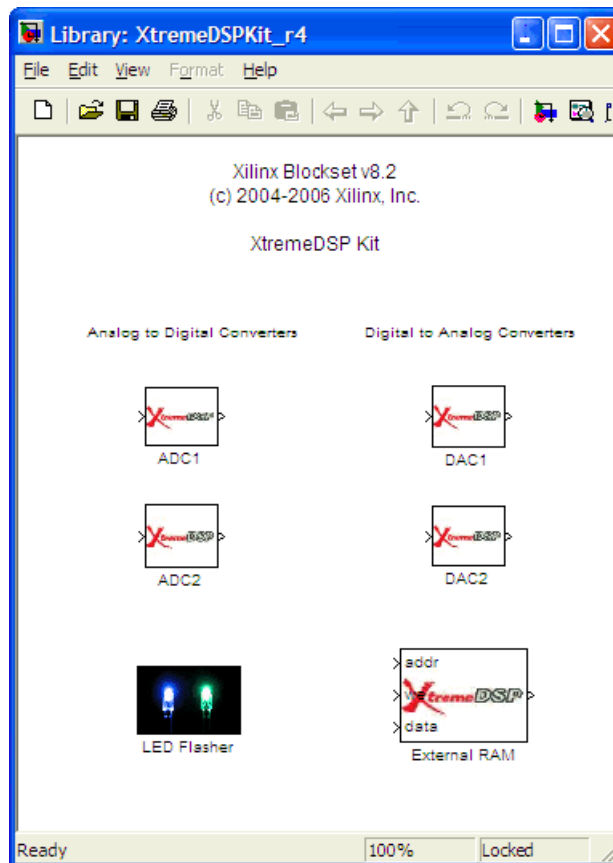

## I/O Ports in Hardware Co-simulation

A hardware co-simulation block does not include board-specific ports on its external interface. This means that if a model includes a gateway that corresponds to a board-specific port, the corresponding port is connected to the simulation model instead of the actual hardware when the design is compiled for hardware co-sim. To leave the port connected to a real port, use a non-memory mapped gateway instead. See the topic on non-memory-mapped ports [Supporting New Boards](#).

## Ethernet Hardware Co-Simulation

System Generator provides hardware co-simulation interfaces that facilitate high-throughput communication with an FPGA board over an Ethernet connection. These interfaces eliminate the communication range limitation imposed by programming cable solutions, while also offering superior bandwidth for real-time applications. By supporting device configuration over Ethernet, there is no need for a separate programming cable.

Two flavors of Ethernet hardware co-simulation are supported by the tool. Point-to-point Ethernet co-simulation provides a straightforward high-performance co-simulation environment using a direct, point-to-point Ethernet connection between a PC and FPGA board. Network-based Ethernet Co-Simulation allows communication with a remote FPGA through the widely deployed IPv4 network infrastructure.

## Point-to-Point Ethernet Hardware Co-Simulation

Point-to-point Ethernet Hardware Co-simulation provides a co-simulation interface using a raw Ethernet connection. The raw Ethernet connection refers to a Layer 2 (a.k.a. Data-Link Layer) Ethernet connection, between a supported FPGA development board and a host PC, with no network routing equipment along the path. By taking the advantage of the ubiquity and advancement of Ethernet technologies, the interface facilitates a convenient and high-bandwidth co-simulation to an external FPGA device.

### Interface Features

The interface supports 10/100/1000 Mbps half/full duplex modes. Jumbo Frame is also supported on a Gigabit Ethernet, provided it is enabled by the underlying connection. For FPGA device configuration, the interface supports either JTAG-based configuration over a Xilinx Parallel Cable IV or a Xilinx Platform USB cable, or, for selected boards, Ethernet-based configuration over the same Point-to-point Ethernet connection for co-simulation.

**Note:** This co-simulation interface utilizes an evaluation version of the Ethernet MAC core. Because this is an evaluation version of the core, it will become dysfunctional after continuous, prolonged operation (e.g., around 7 hours) in the target FPGA. Operation of the core will restart with a new simulation. For more information about obtaining the full version of the core, please visit the product page at [http://www.xilinx.com/xlnx/xebiz/designResources/ip\\_product\\_details.jsp?key=TEMAC](http://www.xilinx.com/xlnx/xebiz/designResources/ip_product_details.jsp?key=TEMAC).

### Supported FPGA Development Boards

Development boards that support point-to-point ethernet hardware co-simulation are listed in the topic [Ethernet-Based Hardware Co-Simulation](#). Links to the appropriate board installation instructions are also provided.

### Configuring Co-Simulation Block Parameters

There are several block parameters specific to the Point-to-point Ethernet co-simulation interface. The rest of this topic describes step-by-step how to configure the parameters of the Point-to-point Ethernet co-simulation block. Refer to the topic [Point-to-point Ethernet Co-Simulation](#) in the Xilinx Block section for details of all the block parameters.

1. Use the **Basic** tab to select the appropriate clock source for the co-simulation.

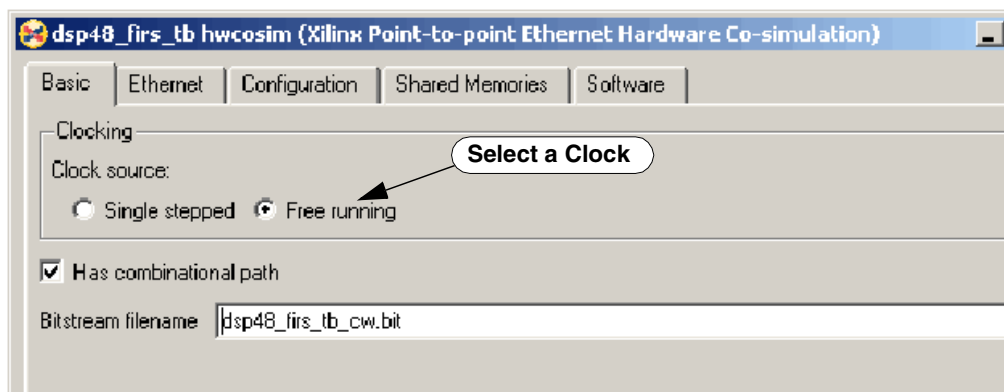

2. Use the **Configuration** tab to select the Configuration Method:

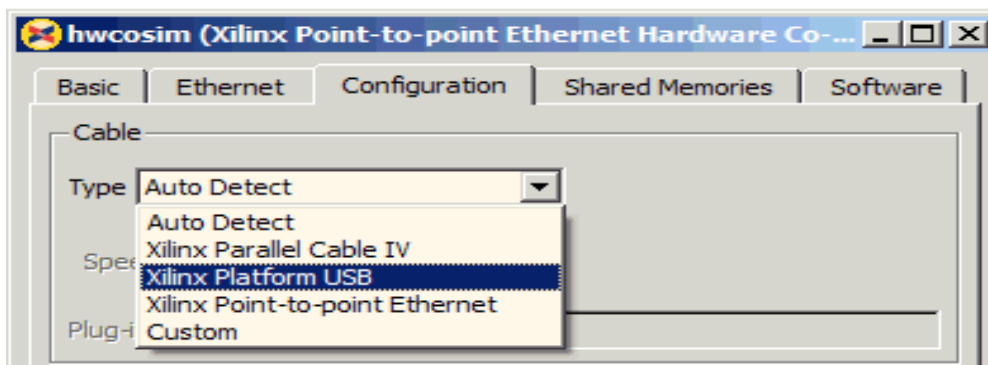

- ◆ For the **Download cable** panel, choose **Point-to-point Ethernet**.
- ◆ For JTAG-based download cables (**Parallel Cable IV** or **Platform USB**), change the cable speed if the default value is not suitable for the cable in use.
- ◆ Change the **Configuration timeout (ms)** value only when necessary. The default value should suffice in most cases. A larger value is needed when it takes a considerable amount of time to re-establish a network connection with the FPGA board after device configuration completes.
- ◆ If there is a Video I/O daughter card attached to the ML402 board, select **Video I/O Daughter Card (VIO DC)** from the **Configuration profile** pulldown menu

3. Use the **Ethernet** tab to configure the Ethernet Interface Settings:

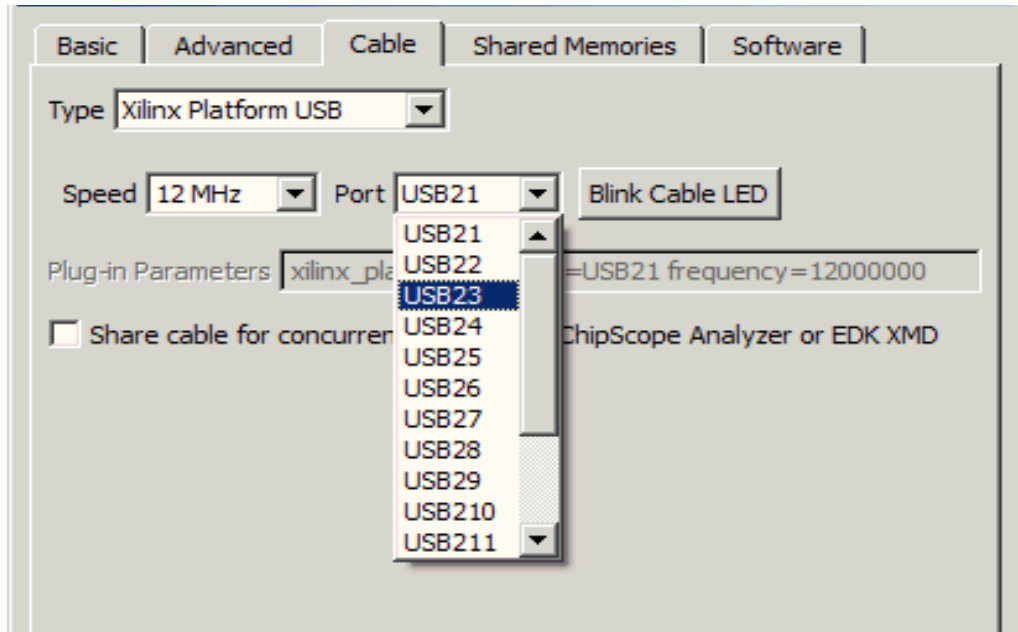

- ◆ From the **Host interface** panel, use the pulldown list to select the appropriate network interface for co-simulation.
 

**Note:** The pull down list only shows those Ethernet-compatible network interfaces installed on the host, which support 10/100/1000 Mbps, and are currently enabled and attached to an active Ethernet segment. If the target interface is not listed as expected, examine the connection and click the **Refresh** button to update the list.
  - ◆ The information box beneath the pull-down list provides the details about the selected interface. Examine the information to ensure the appropriate interface is chosen, and adjust the network settings in the operating system when necessary.
4. Depending on which configuration method is chosen, the MAC address in the **FPGA interface** panel may need to be changed:
- a. For Point-to-point Ethernet-based configuration:
 

Observe the MAC address displayed on the LCD screen of the target board when the configuration boot-loader is running. Change the FPGA MAC address in the co-simulation block if the default value does not match the target board. Refer to [Optional Step to Set the Ethernet MAC Address and the IPv4 Address](#) for details about assigning the MAC address on a ML402 board.

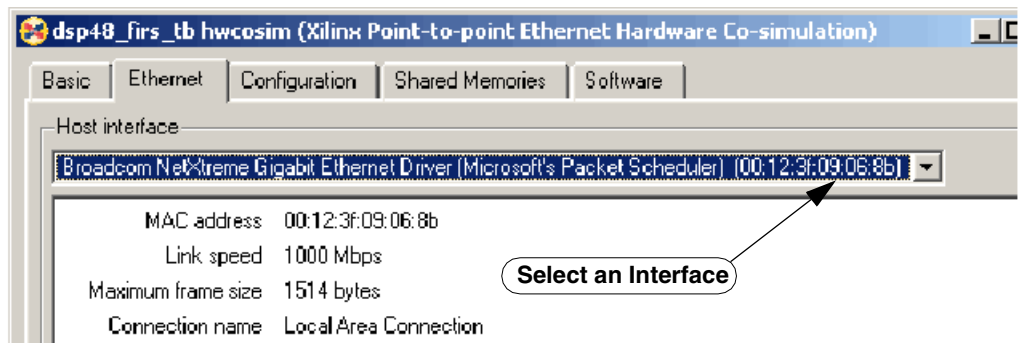

**Note:** The MAC address must be specified using six pairs of two-digit hexadecimal number separated by colons (for example, 00:0a:35:11:22:33).

## Co-Simulating the Design

After setting the block parameters appropriately, you may begin co-simulation by pressing the Simulink **Start** button. System Generator automates the device configuration process and transfers the design under test (DUT) into the FPGA device for co-simulation. A dialog box will be shown to describe the status of the process.

1. The final configuration file is first generated based on the input bitstream specified in the block parameters.

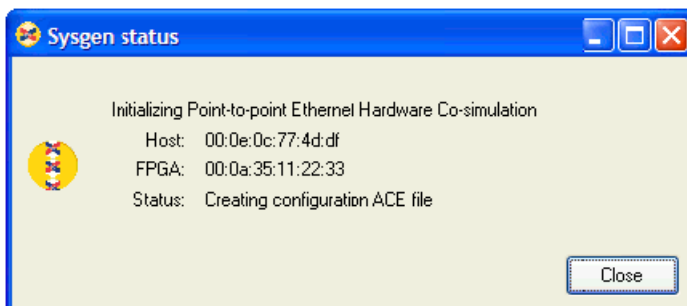

2. The final configuration file is then transferred to the target board using the selected download cable, and used to configure the FPGA device. The progress of configuration is shown in the dialog box when the configuration is performed over a Point-to-point Ethernet connection.

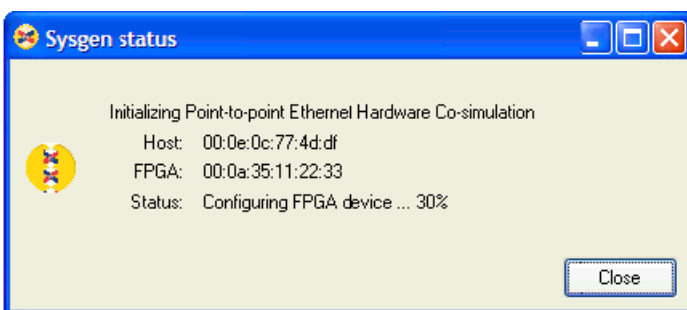

3. Upon the completion of device configuration, the co-simulation engine re-establishes the connection to the target board, and starts co-simulating the design.

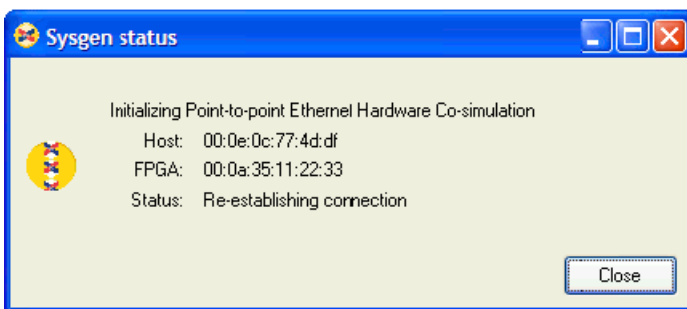



## Known Issues

- If you encounter problems transmitting data over a point-to-point Ethernet connection or experience instability issues, please disable the Hyper-Threading option in the BIOS on an Intel board.
- IP fragmentation is not supported by the network-based Ethernet configuration. Please consult with your network administrator or the user manual for the Ethernet interface card to ensure that the connection established between the host and the target FPGA board can handle a maximum transmission unit (MTU) size of at least 1300 bytes without fragmentation. The MTU size (or similarly maximum frame size setting such as “maximum transfer size” or “jumbo frame size”) may be determined or changed through the Ethernet interface settings.

## Network-Based Ethernet Hardware Co-Simulation

### Interface Features

The interface supports operations in 10/100/1000 Mbps half/full duplex modes. For FPGA device configuration, the interface supports Ethernet-based configuration over the same network connection for co-simulation. This means that a separate programming cable (e.g., Parallel Cable IV) is not required.

**Note:** This co-simulation interface utilizes an evaluation version of the Ethernet MAC core. Because this is an evaluation version of the core, it will become dysfunctional after continuous, prolonged operation (e.g., around 7 hours) in the target FPGA. Operation of the core will restart with a new simulation. For more information about obtaining the full version of the core, please visit the product page at [http://www.xilinx.com/xlnx/xebiz/designResources/ip\\_product\\_details.jsp?key=TEMAC](http://www.xilinx.com/xlnx/xebiz/designResources/ip_product_details.jsp?key=TEMAC).

### Supported FPGA Development Boards

The Xilinx ML402 and ML506 development board is currently supported for the network-based Ethernet co-simulation.

### Setup Procedures

1. Network-based Ethernet co-simulation performs device configuration over the network configuration. Before using network configuration, you must ensure the IP address, MAC address, and configuration server are properly setup on the System ACE™ CompactFlash. Refer to the topic [Optional Step to Set the Ethernet MAC Address and the IPv4 Address](#) for information on how to do this.
2. The target FPGA listens on the UDP port 9999. Please ensure the underlying network does not block the associated traffic.

## Known Issues

- IP fragmentation is not supported by the network-based Ethernet configuration. Please consult with your network administrator or the user manual for the Ethernet interface card to ensure that the connection established between the host and the target FPGA board can handle a maximum transmission unit (MTU) size of at least 1300 bytes without fragmentation. The MTU size (or similarly maximum frame size setting such as “maximum transfer size” or “jumbo frame size”) may be determined or changed through the Ethernet interface settings.

## Remote JTAG Cable Support in JTAG Co-Simulation

Starting with Release 12.2, JTAG Co-simulation supports a remote JTAG cable connection via the CSE (ChipScope Engine) server (which is also being used with iMPACT software and ChipScope Pro software). This allows you to run JTAG Co-simulation over a JTAG cable that is connected to a board in a remote location.

### Specifying the Cable Location

As shown in the figure below, the “Cable Location” option on the Cable tab of the JTAG Co-simulation block is used to specify the location of the cable.

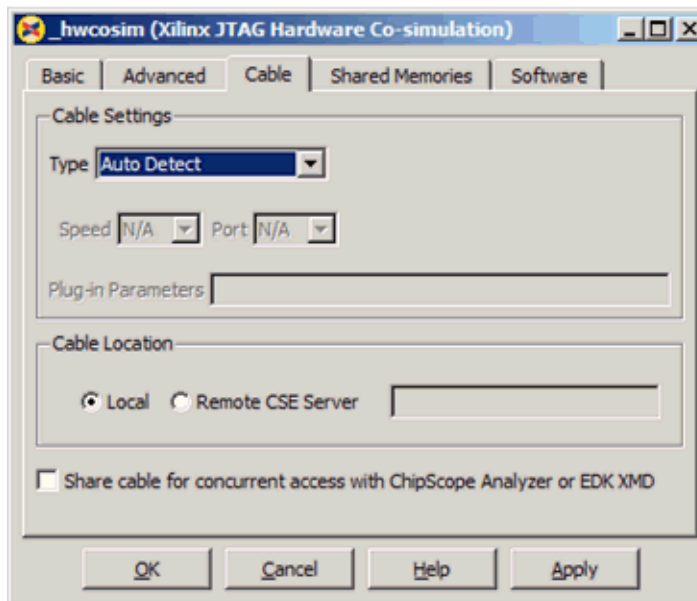

If the Cable Location is set to **Local**, a local JTAG cable is used.

If the Cable Location is set to **Remote CSE Server**, you can specify a CSE server, in form of a host name or an IP address, followed by an optional port number:

```
<host name or IP address> [ :<port number> ]
```

If you omit the port number, the default port number is used by the CSE server.

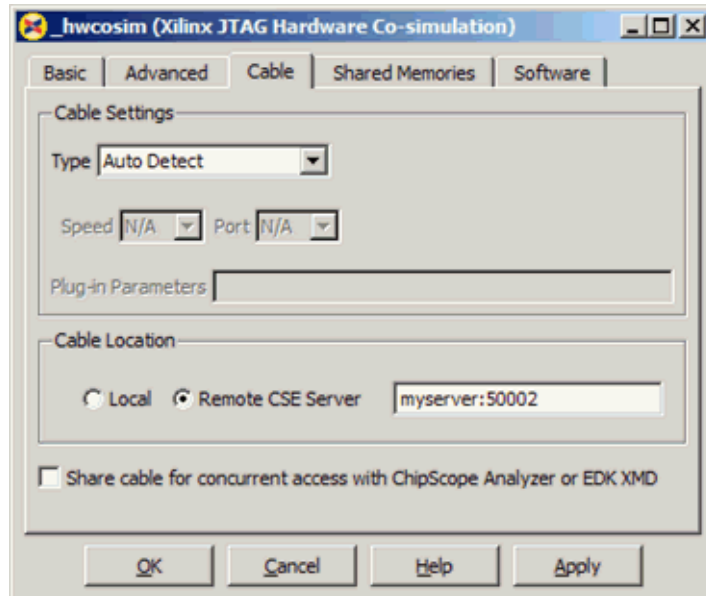

## Starting Up a CSE server

Before starting JTAG co-simulation, you need to start the CSE server on the remote machine that connects to the target board with a JTAG cable. The CSE server can be started by simply running the CSE server executable located in the ISE installation:

- **Windows 32-bit:** <ISE\_tree>\bin\nt\cse\_server.exe
- **Windows 64-bit:** <ISE\_tree>\bin\nt64\cse\_server.exe
- **Linux 32-bit:** <ISE\_tree>/bin/lin/cse\_server
- **Linux 64-bit:** <ISE\_tree>/bin/lin64/cse\_server

cse\_server starts a CSE server with the default port number.

cse\_server -port <port number> starts a CSE server with the given port number.

## Shared Memory Support

System Generator's hardware co-simulation interfaces allow shared memory blocks and shared memory block derivatives (e.g., Shared FIFO and Shared Registers) to be compiled and co-simulated in FPGA hardware. These interfaces make it possible for hardware-based shared memory resources to map transparently to common address spaces on the host PC. When applied to System Generator co-simulation hardware, shared memories can help facilitate high-speed data transfers between the host PC and FPGA, and further bolster the tool's real-time hardware co-simulation capabilities. This topic describes how shared memories can be used within the context of System Generator's hardware co-simulation framework.

<a href="#">Compiling Shared Memories for Hardware Co-Simulation</a>	Describes how to compile a System Generator design for hardware co-simulation when the design contains shared memory blocks.
<a href="#">Co-Simulating Unprotected Shared Memories</a>	Describes how shared memory blocks configured with unprotected access mode behave during hardware co-simulation.
<a href="#">Co-Simulating Lockable Shared Memories</a>	Describes how shared memory blocks configured with lockable access mode behave during hardware co-simulation.
<a href="#">Co-Simulating Shared Registers</a>	Describes how to compile a System Generator design for hardware co-simulation when the design contains shared Registers.
<a href="#">Co-Simulating Shared FIFOs</a>	Describes how to compile a System Generator design for hardware co-simulation when the design contains shared FIFOs.
<a href="#">Restrictions on Shared Memories</a>	Lists the restrictions that are imposed when using shared memory blocks with hardware co-simulation.

## Compiling Shared Memories for Hardware Co-Simulation

System Generator allows shared memory and shared memory derivative (e.g., shared FIFO and shared register) blocks to be compiled for hardware co-simulation. Designs that include shared memories are compiled for hardware co-simulation the same way traditional System Generator designs are compiled – by selecting a compilation target and pressing the **Generate** button on the System Generator dialog box. A design containing shared memory blocks may be compiled for hardware co-simulation provided the requirements described in the topic [Restrictions on Shared Memories](#) are satisfied.

When a shared memory is compiled for hardware co-simulation, it is implemented in hardware either by a core or HDL component. The table below shows how shared memory blocks are mapped to hardware implementations

To Block	From Block	Hardware Implementation
Shared Memory	Shared Memory	Dual Port Block Memory
To FIFO	To FIFO	Fifo Generator
To Register	To Register	synth_reg_w_init.(vhd,v)

There are two ways in which shared memories are compiled for hardware co-simulation. The type of compilation depends on whether the shared memory name is unique in the design, or if the shared memory has a partner who shares the same name. The following topics describe the two types of compilation behavior.

### Single Shared Memory Compilation

A shared memory block is considered "single" if it has a unique name within a design. When a single shared memory is compiled for hardware co-simulation, System Generator builds the other half of the memory and automatically wires it into the resulting netlist. Additional interfacing logic is attached to the memory that allows it to communicate with the PC. When you co-simulate the shared memory, one half of the memory is used by the logic in your System Generator design. The other half communicates with the PC interfacing logic as shown in the figure below. In this manner, it is possible to communicate with the shared memory embedded inside the FPGA while a simulation is running.

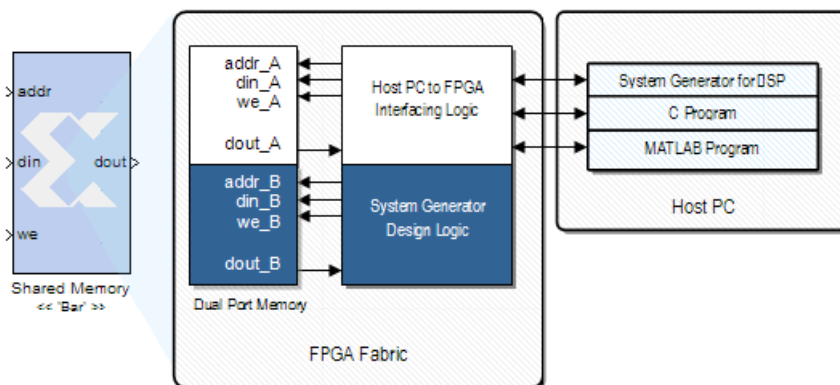

The shared memory hardware and interface logic are completely encapsulated by the hardware co-simulation block that is generated for the design. By co-simulating a hardware co-simulation block that contains a shared memory, it is possible for your design logic and host PC software to share a common address space on the FPGA.

**Note:** The name of the hardware shared memory is the same as the shared memory name used by the original shared memory block. For example, if a shared memory block uses "my\_memory," the hardware implementation of the block can be accessed using the "my\_memory" name.

All shared memories embedded inside the FPGA are automatically created and initialized before the start of a simulation by their respective co-simulation blocks. This means that any other shared memory objects that wish to access the hardware shared memory must specify Ownership and initialization parameter as Owned and initialized elsewhere. Doing so causes the software-based shared memories to attach automatically to the shared memories that reside inside the FPGA.

## Compiling Shared Memory Pairs

It is also possible to compile a shared memory pair (i.e., two shared memories that specify the same name) for hardware co-simulation. In this case, the two shared memory halves are merged into a single hardware implementation during compilation. Unlike single shared memories, both sides of a shared memory pair connect to System Generator user design logic. For example, the figure below shows the hardware implementation for a To / From FIFO shared memory pair.

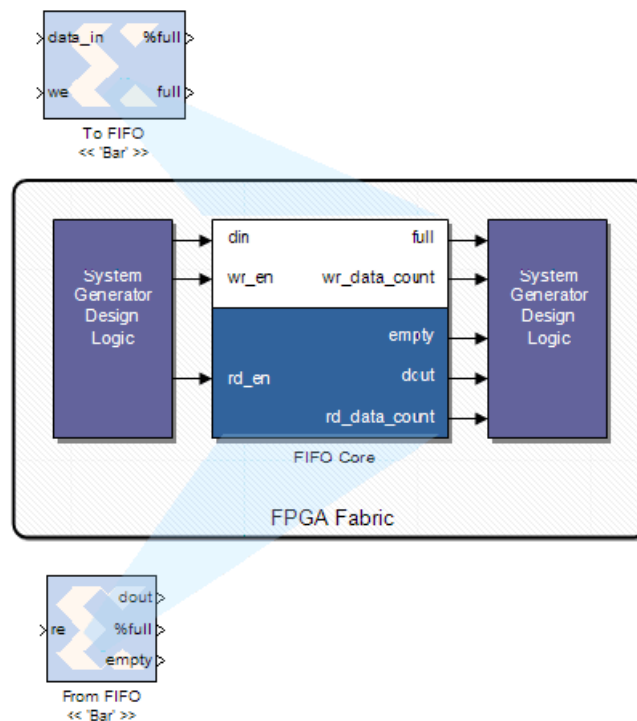

Note that because both sides of the shared memory connect to user design logic, it is not possible to communicate with these shared memories directly from the host PC.

## Viewing Shared Memory Information

Hardware co-simulation blocks allow you to view information about the shared memories that were compiled as part of the design. A hardware co-simulation block that contains shared memories will have an enabled **Shared Memories** tab in the block configuration dialog box shown below. Clicking on this tab exposes a table of information about each shared memory in the design.

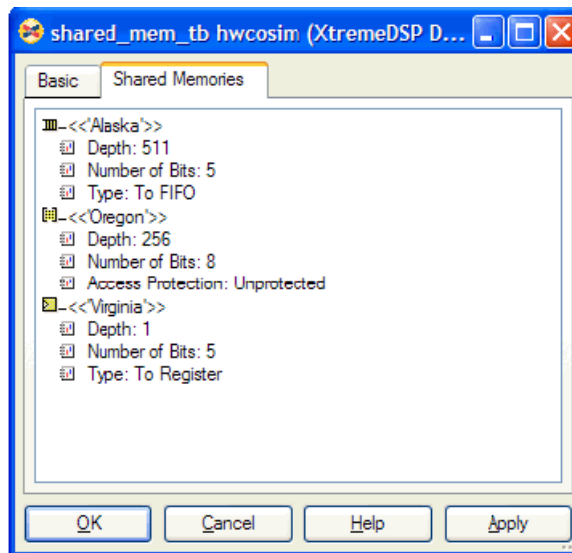

The shared memory information table describes the type, bit width, and depth of each shared memory in the design. For Shared Memory blocks, it also specifies the **Access Protection** mode. Clicking on the [+] or [-] symbol next to the shared memory icon expands or collapses the shared memory table, respectively.

The icons associated with each shared memory type are shown in the table below.

Memory Type	Icon
Shared Memory	
Shared FIFO	
Shared Register	

## Co-Simulating Unprotected Shared Memories

Unprotected shared memory blocks may be written to or read from at any time – this type of memory has no notion of mutually exclusive access. Data transfers to and from an unprotected hardware shared memory occur a single-word at a time, unlike the high-speed data transfer mode used by lockable shared memories. To ensure data coherency between software and hardware, a single image of the shared memory data is shared between hardware and software. This image is stored in the FPGA using dual port memory. System Generator allows both hardware design logic and other software-based shared memory objects on the host PC to access the shared memory data concurrently.

When software shared memory objects read or write data to the shared memory, a proxy seamlessly handles communication with the hardware memory resource.

The following figure shows an example of unprotected shared memory implemented in the FPGA that is communicating with three shared memory objects running on the host PC. In this example, the software shared memory objects access the hardware shared memory by specifying the same shared memory name, `my_mem`. From the perspective of the software shared memories, the implementation of the shared memory resource is irrelevant; the hardware shared memory is treated as any another shared memory object. Read and writes to the shared memory are handled by the shared memory API.

**Note:** Not all shared memory objects need to be created or executed in the Simulink environment. The C++ application in the figure below is just one example of an external application that may communicate with the hardware shared memory data using the shared memory API.

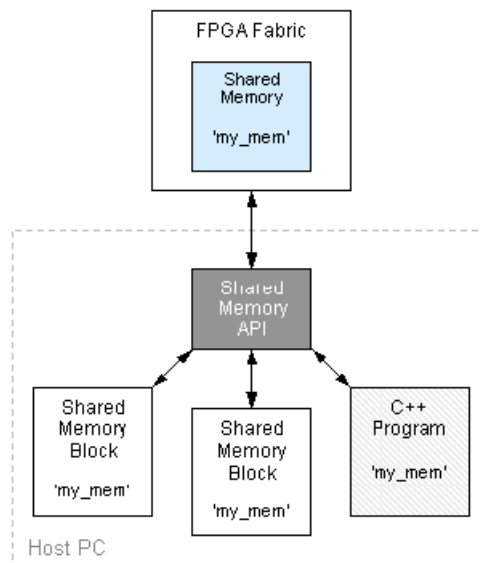

## Co-Simulating Lockable Shared Memories

In lockable access mode, the System Generator co-simulation hardware must acquire lock over the shared memory object before it may access its contents. When the hardware acquires (releases) lock of the shared memory, the memory contents are transferred to (from) the FPGA using a high-speed data transfer. Using this methodology, it is possible to implement System Generator hardware co-simulation designs with high memory bandwidth requirements. For more information on how to do this, refer to the tutorial entitled [Real-Time Signal Processing using Hardware Co-Simulation](#).

Unlike unprotected shared memories, two images of the shared memory data are used when a lockable shared memory is co-simulated. One memory image is stored using dual port memory in the FPGA. This image is accessed by the System Generator hardware co-simulation design and co-simulation interfacing logic. The other image is implemented as a shared memory object on the host PC. This software shared memory image is accessed by any software shared memory objects used in a design.

In lockable mode, a software process or hardware circuit that wishes to access the shared memory must first obtain the lock. If the hardware has lock of the memory, no software objects may access the memory contents. Likewise, if a software object controls the memory, the hardware cannot read or write to the memory. Note that lockable hardware



shared memories include additional logic to handle the mutual exclusion. The interaction between hardware and software lockable shared memories is shown in the figure below: .

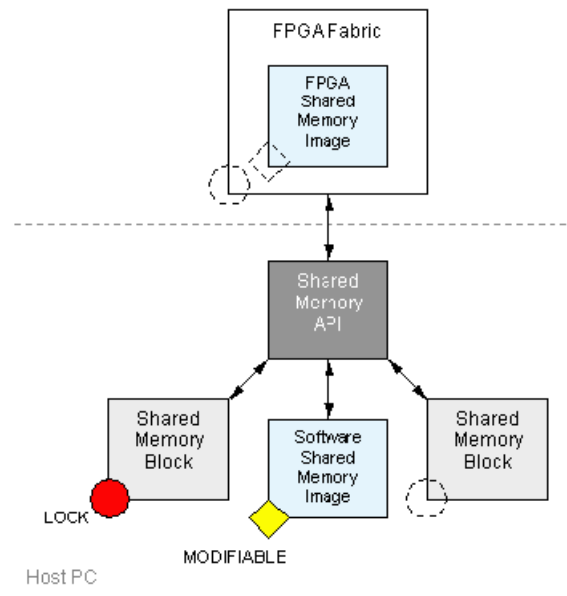

The red circle in the figure above represents a lock token. This token may be passed to any shared memory object, regardless of whether it is implemented in hardware or software. The dashed circle represents lock placeholders and signifies that lock can be passed to the block it is associated with. The diamond in the figure above represents a modifiable token. This token illustrates that when hardware has lock of the memory, the hardware shared memory image may be modified. Likewise, when a software shared memory object has lock, the software shared memory image may be modified.

Having two shared memory images requires synchronization between software and hardware to ensure the images are coherent. This synchronization is accomplished by transferring the memory image between software and hardware upon lock transfer.

System Generator performs high speed data transfers between the host PC and FPGA. The semantics associated with these transactions are shown in the figure below. .

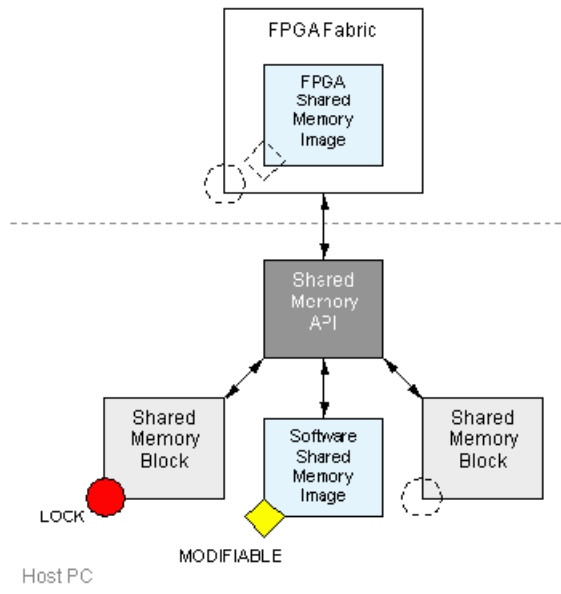

## Co-Simulating Shared Registers

A [To Register](#), [From Register](#) or shared register pair may be generated and co-simulated in FPGA hardware. Here and throughout this topic, a shared register pair is defined as a To Register block and From Register block that specify the same name (e.g., 'Bar'). In hardware, a shared register is implemented using a synthesizable register component (for VHDL) or a module (for Verilog). This topic explains how single shared registers and shared register pairs behave during hardware co-simulation.

When a design that includes a shared register pair is compiled for hardware co-simulation, the pair is replaced by a single register instance. Both sides of the register attach to user design logic; that is, logic that originated from the original System Generator model. Unlike designs compiled using the [Multiple Subsystem Generator](#) block, all ports on the hardware register attach to signals in the same clock domain. In this case, control of the register is not shared between the PC and FPGA hardware since all register ports are attached to user design logic. Compiling a shared register pair into hardware is equivalent to compiling a System Generator [Register](#) or [Delay](#) block.

Compiling a single To Register or From Register block for hardware co-simulation results in a different type of implementation. A single register is still created to replace the To or From Register block. Only in this case, the register connects to both the PC interface and FPGA logic. The side of the register in the original model remains connected to user design logic. The other side of the register attaches to data and control ports that interface with the PC.

For example, in the following figure, when a From Register block is compiled for hardware co-simulation, the `dout` register port remains attached to the user design. The `din`, `ce`, and `clk` register ports attach to control and data ports that interface with the PC. In this way, it

is possible for the PC to write to the register using System Generator's hardware co-simulation interfaces.

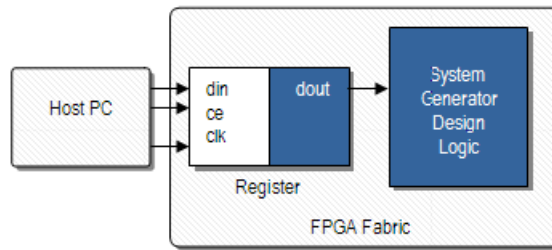

When a To Register block is compiled for hardware co-simulation, as shown in the figure below, the input ports are wired to user logic while the output port is wired to PC interface logic. You may access a shared register during hardware co-simulation using the other half of the shared register (i.e., using a To or From Register block), a C program or executable (System Generator API), or a MATLAB program.

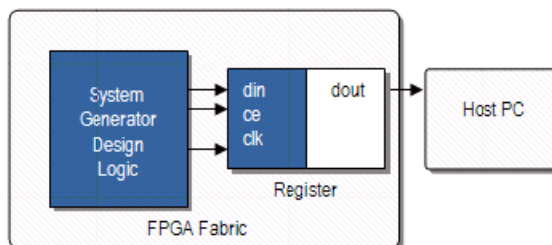

For designs that use hardware co-simulation, shared register pairs are typically distributed between software and FPGA hardware. In other words, one half of the pair is implemented in the FPGA while the other half is simulated in software using a To or From Register block. When data is written to a software To Register block, the hardware register is updated to with the same data. Similarly, when data is written into the hardware register, the same data is read by the From Register software block. A software shared register may connect to a hardware shared register simply by specifying the name of the shared register as it was compiled for hardware co-simulation.

**Note:** You may find the names of all shared memories embedded inside an FPGA co-simulation design by viewing the Shared Memories tab on a hardware co-simulation block.

When a software / hardware shared memory pair is co-simulated, System Generator transparently manages the interaction between the PC and FPGA hardware. This means that a shared register pair simulated in software should behave the same as a shared register pair distributed between the PC and FPGA hardware.

## Co-Simulating Shared FIFOs

A [To FIFO](#), [From FIFO](#) or *shared FIFO pair* may be generated and co-simulated in hardware. Here and throughout this topic, a shared FIFO pair is defined as a To FIFO block and From FIFO block that specify the same name (e.g., 'Bar'). In hardware, a shared FIFO is implemented using the FIFO Generator core. The core is configured to use independent (asynchronous) clocks, and block memory for data storage. This topic explains why co-simulating shared FIFOs is useful, and also how these blocks behave in hardware.

Asynchronous FIFOs are typically used in multi-clock applications to safely cross clock domain boundaries. When a [Free-Running Clock](#) mode is used for hardware co-simulation, the FPGA operates asynchronously relative to the Simulink simulation. That is, the FPGA is not kept in lockstep with the simulation. Using the Free-Running Clock mode effectively establishes two clock domains: the Simulink simulation clock domain and the FPGA free-running clock domain. In these designs, Shared FIFOs provide a reliable and safe way to transfer data between the host PC and FPGA board.

Shared FIFOs may also be used to support burst transfers during co-simulation. It is possible to create vectors or frames of data, and transfer the data to the FPGA in a single transaction with the hardware. These interfaces can be used to further accelerate simulation speeds beyond what is typically possible with hardware co-simulation. For more information on how this is accomplished, refer to the topic [Frame-Based Acceleration using Hardware Co-Simulation](#).

When a shared FIFO pair is generated for co-simulation, a single asynchronous FIFO core replaces the two software shared FIFO blocks. As shown in the figure below, the read / write FIFO sides are attached to user design logic (i.e., logic derived from the original System Generator model) that attached to the From FIFO and To FIFO blocks. Because both FIFO sides attach to user logic in hardware, the PC does not share control of the FIFO with the design. Instead, the FIFO behavior is similar to a System Generator design that includes a traditional FIFO block.

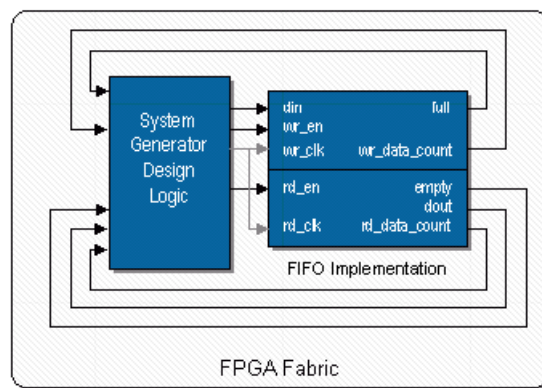

Note that even though the FIFO exposes independent clock ports, the same co-simulation clock drives both ports when a FIFO pair is compiled. This is different from compiling a shared FIFO pair using the [Multiple Subsystem Generator](#) block, where the clocks are from distinct clock domains.

Single shared FIFO blocks are treated differently than shared FIFO pairs. A single To FIFO or From FIFO block is replaced by an asynchronous FIFO core when it is compiled for hardware co-simulation. One side of the FIFO (i.e., the unused shared FIFO half in System Generator) is connected to PC interface logic. The other side is connected to user design logic that attached to the original To or From FIFO block. In this manner, control over the FIFO is distributed between the PC and FPGA design.

As shown in the following figure, when a To FIFO block is compiled for hardware co-simulation, the write side of the FIFO is connected to the same logic that attached to To

FIFO block in user design. The read side of the FIFO is connected to PC interface logic that allows the PC to read data from the FIFO during simulation.

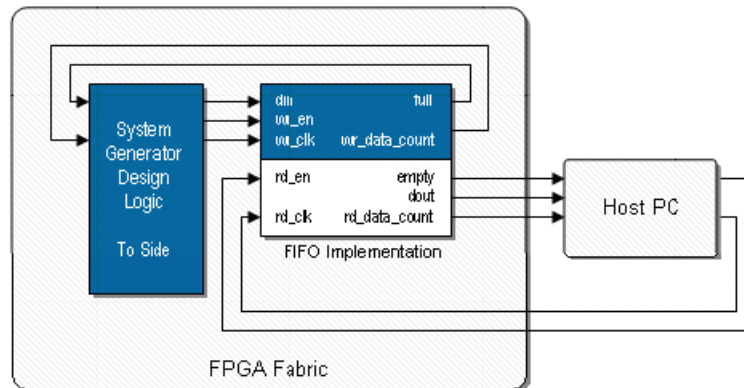

In the figure below, the opposite wiring approach is used when a From FIFO block is compiled for hardware co-simulation. In this case, the write side of the FIFO is connected to PC interface logic, while the read side is connected to the user design logic. The host PC writes data into the FIFO and the design logic may read data from the FIFO.

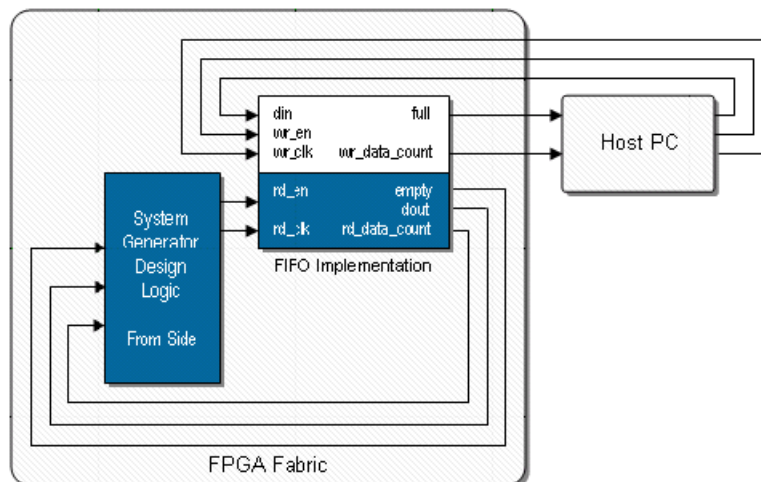

For designs that use hardware co-simulation, shared FIFO pairs are typically distributed between software and FPGA hardware. In other words, one half of the pair is implemented in the FPGA while the other half is simulated in software using a To or From FIFO block. Together, the software and hardware portions form a fully functional asynchronous FIFO. When a software / hardware shared FIFO pair is co-simulated, System Generator transparently manages the necessary transactions between the PC and FPGA hardware.

When data is written to a software To FIFO block during simulation, the same data is written to the FIFO in hardware. The design in hardware may then retrieve this data by reading from the FIFO. Similarly, when data is written into the hardware FIFO by design logic, the data may be read by the From FIFO software block. Note that the empty, full, read and write count ports on the shared FIFO blocks pessimistically reflect the state of the hardware FIFO counterpart. A software shared FIFO may connect to a hardware shared FIFO simply by specifying the name of the shared FIFO as it was compiled for hardware co-simulation.

**Note:** You may find the names of all shared memories embedded inside an FPGA co-simulation design by viewing the Shared Memories tab on a hardware co-simulation block.

## Restrictions on Shared Memories

The following restrictions apply to System Generator designs that use shared memory, register, or FIFO blocks in conjunction with hardware co-simulation:

- The access protection mode of a shared memory may not be modified once it has been compiled for hardware co-simulation.
- Shared memory address port widths are limited to 24-bits (or less), allowing an address space of 16,777,216 words;
- Shared memory, register, and FIFO data port widths are currently limited to 32-bits or less.
- Shared memories and FIFOs are implemented in hardware using block memories; neither distributed nor external memory implementations are currently supported.
- No more than two shared memories with the same shared memory name may be compiled for hardware co-simulation.
- Two or more hardware co-simulation blocks that have shared memory names in common may not concurrently be used in the same design.

## Specifying Xilinx Tool Flow Settings

When a design is compiled for System Generator hardware co-simulation, the command line tool, XFLOW, is used to implement and configure your design for the selected FPGA board. XFLOW defines various flows that determine the sequence of programs that should be run on your design during compilation. There are typically multiple flows that must be run in order to achieve the desired output results, which in the case of hardware co-simulation targets, is a configuration bitstream.

System Generator uses two flows, *implementation* and *configuration*, in order to produce a configuration bitstream. The implementation flow is responsible for compiling the synthesis tool netlist output (e.g., EDIF or NGC) into a placed and routed NCD file. To accomplish this, it runs the Xilinx tools NGDBuild, MAP, and PAR. The implementation flow can also execute TRACE (for timing analysis purposes), although this program is typically omitted in order to expedite the compilation process. The configuration flow runs the tools necessary to create an FPGA bitstream, using the fully elaborated NCD file as input.

The implementation and configuration flow types have separate XFLOW options files associated with them. An XFLOW options file declares the programs that should be run for a particular flow, and defines the command line options that are used by these tools. Each hardware co-simulation compilation target provides options files that define the default configuration options for these tools. Sometimes you may want to use options files that use settings that differ (e.g., to specify a higher placer effort level in PAR) from the default options provided by the target. In this case, you may create your own options files, or edit the default options files to include your desired settings.

The Hardware Co-Simulation Settings dialog box, shown below, allows you to specify options files other than the default options files provided by the compilation target.

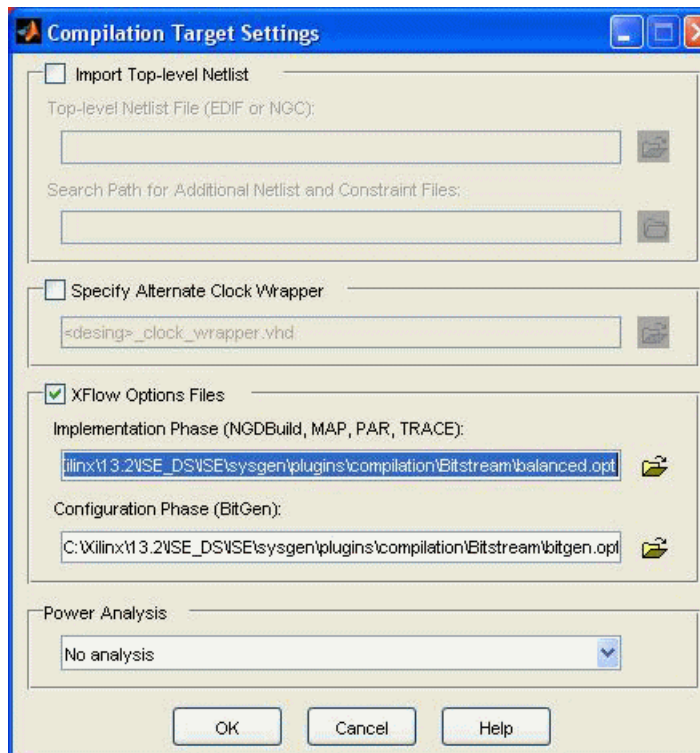

Parameters available on the Hardware Co-Simulation Settings GUI are:

- **Implementation Flow:** Specifies the options file that is used by the implement flow type. By default, System Generator will use the implement options file that is specified by the compilation target.
- **Configuration Flow:** Specifies the options file that is used by the config flow type. By default, System Generator will use the config options file that is specified by the compilation target.

The Xilinx ISE® software includes several example XFLOW options files. From the base directory of your Xilinx ISE software tree, these files are located under the directory `sysgen/plugins/compilation/Bitstream`. Commonly used implementation options files include:

- `balanced.opt`
- `bitgen.opt`

**Note:** It is possible to define options files that may cause errors in the System Generator hardware co-simulation flow. As a result, it is typically a good idea to make backup copies of the default options files before modifying them. In addition, the configuration options file should be edited with caution, as most FPGA hardware boards have specific configuration parameter requirements.



## Frame-Based Acceleration using Hardware Co-Simulation

With the tremendous growth in programmable device size and computational power, lengthy simulation times have become an expected, yet undesirable part of life for most engineers. Depending on the design size and complexity, the required simulation time can be quite large, sometimes on the order of days to run to completion. This problem is exacerbated by the fact that most systems must be simulated many times before the design is considered functional and ready for deployment. Fortunately, System Generator for DSP provides hardware co-simulation interfaces that allow you to dramatically accelerate simulation speeds of your FPGA designs.

There are several factors that influence exactly how much acceleration can be gained by using hardware co-simulation. These considerations include the size of the design, the number of ports on the model, and the hardware over-sampling rate. Under normal operation, the PC communicates with the FPGA during each Simulink simulation cycle. These software / hardware transactions often involve significant overhead and can end up being the limiting factor in simulation performance. Also of importance is the co-simulation interface being used. Some interfaces (e.g., PCI) are faster than others (e.g., JTAG). For a reasonably large design, the typical simulation is accelerated by an order of magnitude when co-simulated in hardware.

Keeping the above points in mind, there are ways to further bolster simulation performance. Remember that every time the PC interacts with hardware, there is an overhead cost that impacts simulation performance. One of the ways the number of FPGA transactions can be mitigated is by utilizing Simulink vector and frame signal types. Here and throughout the rest of this tutorial, FPGA transactions involving Simulink vector and frame signals as simply referred to as `vector transfers`. This idea is straightforward – bundle as many input data samples together as possible and have the FPGA process the data in a single transaction. Fewer transactions with the FPGA results in better simulation performance.

In this tutorial, Simulink vector and frame signals are used to increase simulation performance beyond what is traditionally possible with hardware co-simulation. A step-by-step example filter design is presented to help illustrate these concepts.

Before diving into the details, it is worth exploring exactly what you are trying to accomplish from a high-level perspective. In summary, you will do the following during a Simulink simulation cycle:

- Buffer a series of scalar input data values into a Simulink vector;
- Transfer the vector data to a buffer residing on the FPGA using a burst transfer;
- Use the FPGA, in free-running clock mode, to sequentially process the entire input buffer;
- Use the FPGA to write the data into an output buffer;
- Transfer the contents of the output buffer back into Simulink and reconstruct the data as a Simulink vector;
- Unbuffer the vector into a series of output scalar values.

### Shared Memories

Before a System Generator design can support vector transfers, it must be augmented with appropriate input and output buffers. In hardware, these buffers are implemented using internal memory (e.g., BRAMs) and are used to store vectors of simulation data that are written to and read from the FPGA by the PC. This means that the maximum size of the



buffers is limited by the amount of internal memory available on the target device. In System Generator, shared memory blocks provide interfaces that implement such buffers.

A question that quickly comes to mind is why not use standard FIFO or memory blocks? The buffers required for hardware co-simulation differ from traditional FIFOs and memories in that they must be controllable by both the PC and FPGA user design logic. The standard FIFO and memory blocks provided by System Generator can only interface with user design logic.

There are two types of shared memories that provide this control: lockable shared memories and shared FIFOs. These blocks provide different buffering styles; each with their own handshaking protocols that determine when and how burst transactions with the FPGA occur. In this tutorial, primary attention is focused on shared FIFO buffers. For an example on how to use lockable shared memories, please refer to the tutorial entitled [Real-Time Signal Processing using Hardware Co-Simulation](#). You may find the lockable shared memory and FIFO blocks in the Shared Memory library of the Xilinx Blockset.

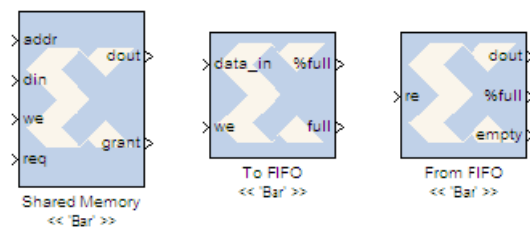

Because shared FIFOs play a central role in enabling vector transfers, it is worth a brief aside to discuss their behavior. A shared FIFO pair is comprised of a To FIFO block and a From FIFO block that specify the same name (e.g., Bar in the figure above). The To FIFO block provides the "write side" control signals, while the From FIFO block provides the "read side" control signals. When used together, a shared FIFO pair is conceptually the same thing as a single FIFO – only the control signals for the two sides are graphically disjoint. This means that a shared FIFO pair shares the same FIFO memory space. For example, if you write data into a To FIFO block, you may retrieve the same data by reading from the From FIFO block. The connection between these two blocks is implicit; shared FIFOs are associated with one another by name and not by explicit Simulink wires.

Shared FIFOs and shared memories in general may be compiled for hardware co-simulation. Note that although this tutorial touches briefly on how shared FIFOs are co-simulated, it is useful to refer to the topic titled [Co-Simulating Shared FIFOs](#) for more in-depth information. When one-half of a shared FIFO block is compiled for hardware co-simulation, a full FIFO block is embedded in the FPGA using the FIFO Generator core. One side of the FIFO connects to user design logic (i.e., the System Generator logic that connected to the shared FIFO block). The other half connects to interface logic that allows it to be controlled by the PC. This side of the FIFO may be controlled by other System Generator software model logic (e.g., the half of the shared FIFO), by a C program or software executable, or by a MATLAB program. By compiling shared FIFOs for hardware

co-simulation, you create embedded FIFO-style buffers in the FPGA that can be controlled directly by a PC.

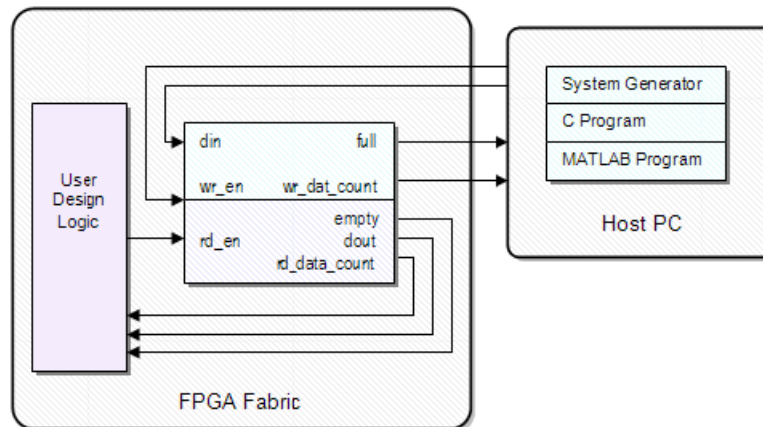

There are several ways to communicate with a shared FIFO that is embedded inside the FPGA. The most common approach is to include the other half of the shared FIFO in the System Generator design. It is also possible to communicate with the shared FIFO using a C program or MATLAB program. System Generator provides additional blocks that support vector transfers to and from the FIFO. These blocks will be touched on later in the tutorial as they play a key role in supporting burst transfers to and from the FPGA.

## Adding Buffers to a Design

Having gained an understanding of how shared FIFOs work in hardware, you will now turn your attention towards building designs that can utilize these buffers for high-speed vector processing in the FPGA.

Consider the scenario in which you have an FPGA data path that you would like to accelerate using vector transfers. You need to include input buffer storage in the FPGA that can store data input samples that are written by the PC. An output buffer is also required so that the processed data values can be stored while the FPGA waits for the PC to retrieve them. With these requirements in mind, a From FIFO block is used to implement the input data buffer and a To FIFO block is used to implement the output data buffer. In the model shown below, data is written into the data path as soon as it shows up in the input FIFO. Note that the data path block contains new data (nd) and data valid (vld) flow control ports. These ports support a simple flow control scheme that determines when new data enters and valid data leaves the data path. The nd signal is asserted whenever there is data

available in the input FIFO. Conversely, data is written into the output FIFO whenever valid data is present on the data path.

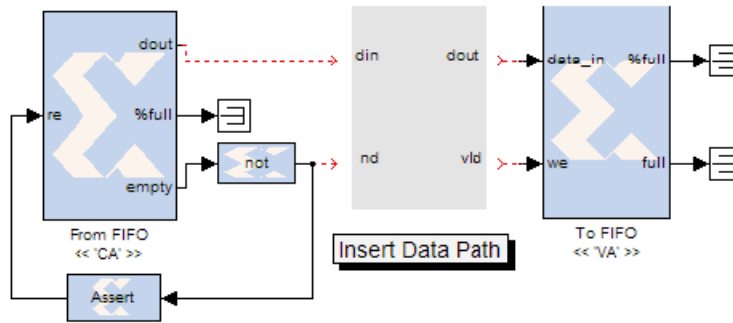

To gain a better understanding of how the Shared FIFOs are used, you will now take a look at an example design that uses vector transfers to accelerate a MAC filter design.

1. From the MATLAB console, change directory to `<ISE_Design_Suite_tree>/sysgen/examples/shared_memory/hardware_cosim/frame_acc.`
2. Open `macfir_sw_w_fifos.mdl` from the MATLAB console.

### Frame-based Acceleration using Hardware Co-simulation

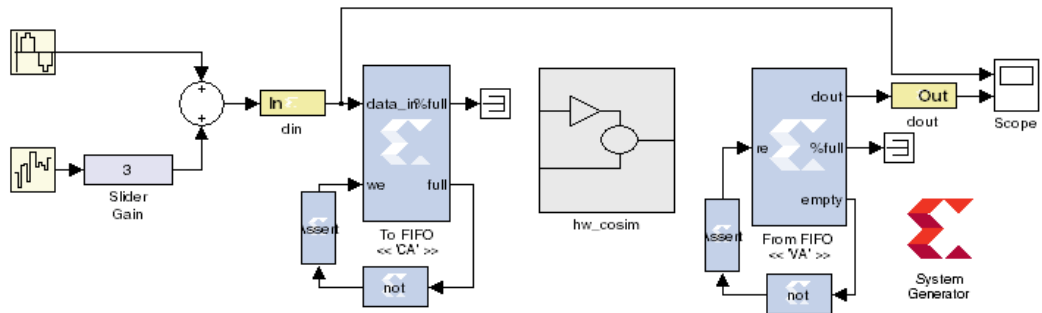

The example design implements a 32-tap MAC FIR filter that removes additive white noise from a sinusoid input source. The amount of white noise can be adjusted interactively by moving the Slider Gain control bar before or during simulation. An output scope compares the filtered output data against the unfiltered input data. The MAC filter itself is contained inside a subsystem named `hw_cosim`. This subsystem contains all of the logic that will be

compiled into the FPGA for hardware co-simulation. You consider everything else in the design (i.e., all blocks in the top-level) as the design test bench.

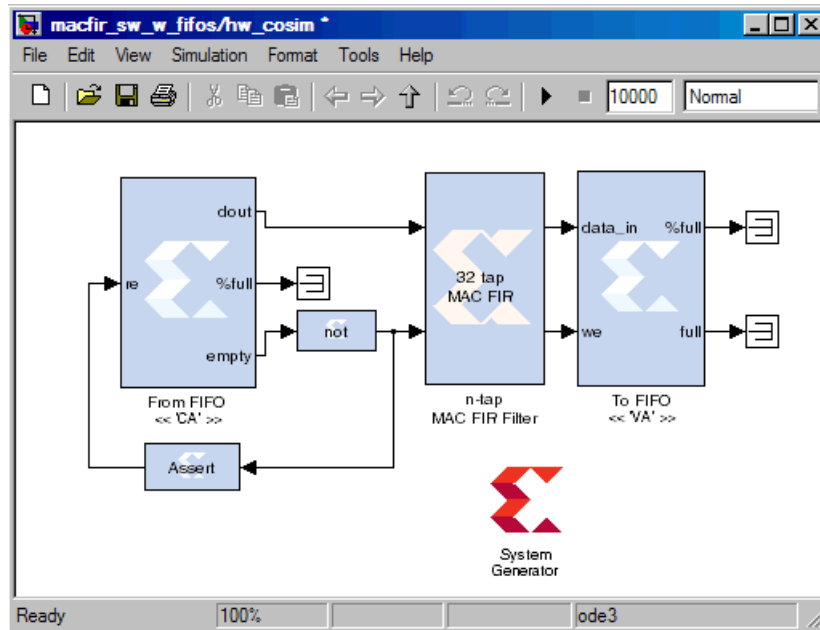

Pushing into the `hw_cosim` subsystem, you have an `n`-tap MAC FIR Filter block that implements the design data path. Wrapping the filter are From FIFO and To FIFO blocks that provide the input and output buffers, respectively. The MAC filter in the example design is a modified version of the `n`-tap MAC filter available in the System Generator DSP Reference Blockset library. In the example, the filter is modified to include valid in and valid out ports in order to support the FIFO flow control scheme.

In total, there are four shared memory blocks in the design that define the CA and VA shared FIFO pairs. In truth, you only need the shared FIFO blocks contained inside the `hw_cosim` subsystem to successfully compile the design for hardware co-simulation. Because you would like to simulate the complete design, including FPGA hardware, you include a CA To FIFO block and VA From FIFO block in the test bench logic. These shared FIFO blocks are responsible for writing and reading test data from the shared FIFOs in the `hw_cosim` subsystem.

Unfiltered data from the `din` Gateway In block is written into the CA To FIFO block. At this point, the CA From FIFO block in the `hw_cosim` subsystem reads data from the FIFO and writes it into the MAC filter. The MAC filter in turn processes the data and writes it into the output buffer, represented by the VA To FIFO block. Lastly, the VA From FIFO block in the top-level reads the data and sends it to the Scope block for visualization.

For this example, you have chosen a maximum buffer size of 4K. This parameter is set by specifying 4K for the Depth parameter on the CA From FIFO and VA To FIFO block dialog boxes. Note that because shared FIFOs are implemented using asynchronous FIFO

Generator cores, the actual depth of the hardware FIFO is  $n-1$  words, where  $n$  is the depth specified on the dialog box.

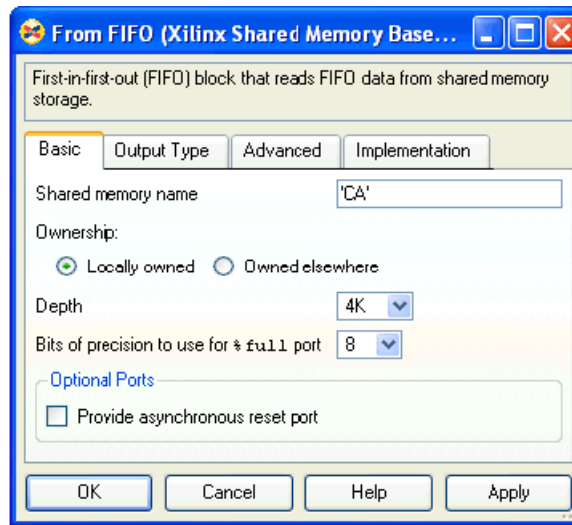

You will now have a chance to simulate the design to see how fast it runs in software.

3. Press the Simulink **Start** button to simulate the design in software.
4. Record the time required to simulate the design for 10000 cycles. To get an accurate measurement, it is preferable to leave the scope block closed since the graphic updates may affect simulation performance.

You may adjust the Slider Gain bar during simulation to see how the presence of additional noise affects the filter performance. You may view the filtered and unfiltered data in the output scope block. The top axis shows the unfiltered input data. The bottom axis shows the filtered data results.

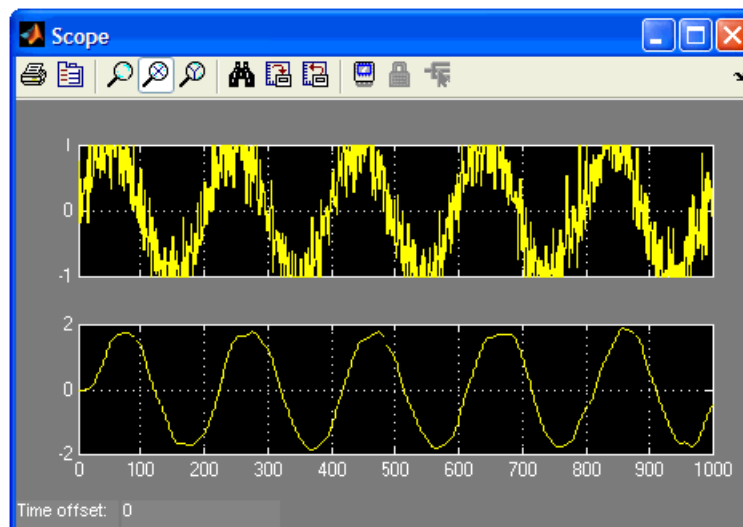

## Compiling for Hardware Co-simulation

You will now compile the design for hardware co-simulation. Before performing the following steps, ensure that you have an appropriate hardware co-simulation board installed in System Generator and attached to your PC. In this example, you only want to compile the portion of the design that resides inside the hw\_cosim subsystem. This is because you want the CA To FIFO and VA From FIFO blocks to remain in software as part of the design test bench (while their partner shared FIFOs are compiled into FPGA logic).

5. Double-click on the System Generator token in the hw\_cosim subsystem to open the System Generator dialog box.
6. From the Compilation submenu, choose an appropriate hardware co-simulation target. Note that although you use the Point-to-point Ethernet hardware co-simulation interface in this example, any installed hardware co-simulation board (e.g., a board that supports JTAG co-simulation) will suffice.

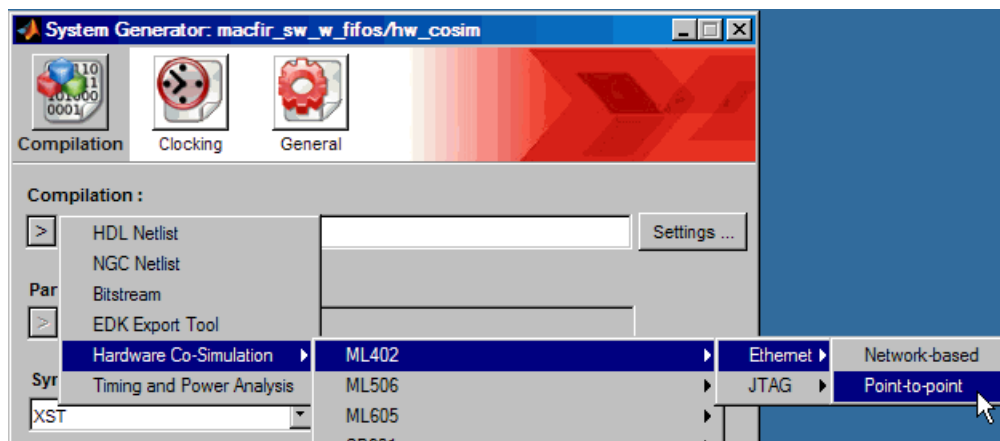

7. Press the **Generate** button on the System Generator dialog box to generate the design.

A new hardware co-simulation library and block are created once System Generator finishes compiling the design. Note that the new hardware co-simulation block does not have any input or output ports. This is because the subsystem that was compiled did not contain gateway blocks or Simulink ports. Instead, all connections to other Simulink blocks are handled implicitly through shared memories that were compiled into the FPGA. Because you left the To FIFO and From FIFO blocks as part of the software testbench, the software FIFOs will automatically attach to the FIFOs in hardware at the beginning of simulation.

It is often necessary to examine the type and configuration of a shared memory that was compiled for hardware co-simulation. The information about each shared memory is available in a Shared Memories tab on the hardware co-simulation block dialog box. This tab contains a tree view of information about each shared memory embedded in the design.

8. Double-click on the hardware co-simulation block to open the parameters dialog box.
9. Select the **Shared Memories** tab in the hardware co-simulation block dialog box.

The tree-view contains information about the CA and VA shared FIFO blocks that were compiled. If your co-simulation design contains other shared memory blocks, information about these blocks will also be displayed here. You may expand or collapse shared

memory information by clicking on the (+) or (-) icons located adjacent to the shared memory icons.

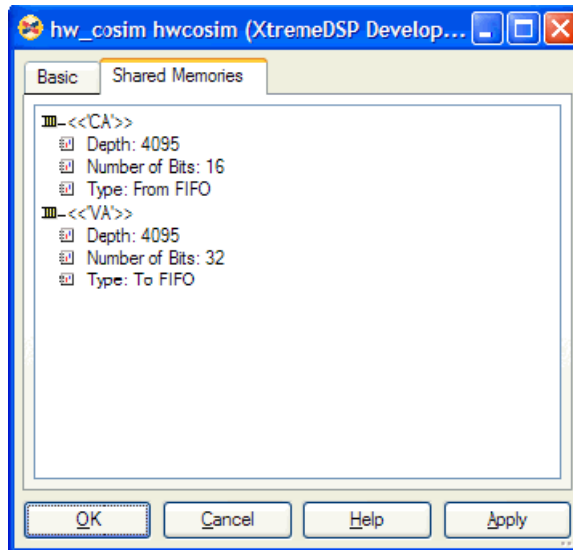

10. Close the parameters dialog box.

You are now ready to insert the hardware co-simulation block in the original design. Before continuing on with the next steps, it is worthwhile to either rename the design or create a backup of the original since you will be making modifications.

11. Remove the hw\_cosim subsystem from the design.

12. Insert the hardware co-simulation block in place of the hw\_cosim subsystem.

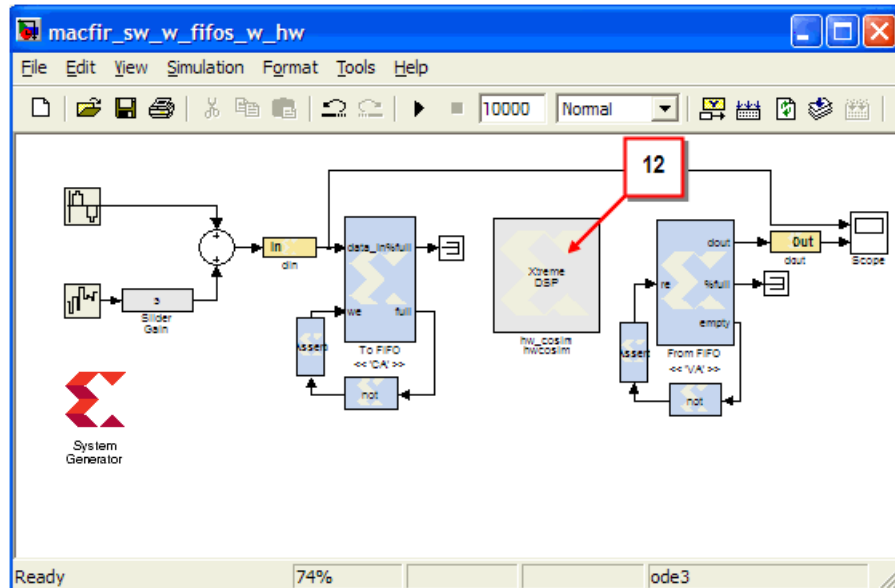

13. Configure the hardware co-simulation block with any settings necessary to co-simulate using single-step clock mode.

14. Press the Simulink **Start** button to start the design.

15. Record the amount of time required to simulate the design for 10000 cycles.
- 
16. Close the design, but leave the hardware co-simulation library open since you will need it in the next topic.

In the simulation above, hardware co-simulation uses single word transfers. That is, whenever there is a new simulation value to be read or written to the hardware co-simulation, the PC initiates a transaction with the FPGA. The next topic describes how vector transfers may be used to increase simulation speed by making more efficient use of the available hardware co-simulation bandwidth.

## Using Vector Transfers

The System Generate Shared Memory Read and Write blocks allow you to use vector transfers with hardware co-simulation. These blocks may be found in the Shared Memory library in the Xilinx Blockset.

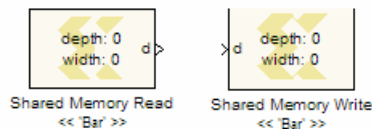

The Shared Memory Write block accepts a Simulink scalar, vector, matrix or frame data type and writes the data sequentially into a shared memory. The complete contents of the Simulink signal are written into the shared memory in a single simulation cycle. As is the case with all shared memory blocks, an association is made between a Shared Memory Read or Write block and another shared memory by specifying the same shared memory name.

Matrix types are treated as having a `column-major` order. That is, when data is written sequentially into a shared memory, the elements in a column are written first before advancing to the next column. For example, assume you have the matrix of data shown below. During simulation, this matrix data is written into the FIFO (or shared memory) in the following order:

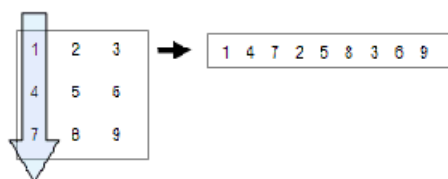

Using these blocks, it is possible to read or write full vector, frame, or matrix signals into shared memories, provided the following conditions are met:

- The input signal driven to a shared memory write block is an 8-bit, 16-bit, or 32-bit signed or unsigned integer;
- The number of elements in the vector or matrix does not exceed the depth of the shared memory or FIFO.
- The data width of the Shared Memory Read or Write block (i.e., the bitwidth of the scalar, or vector or matrix element) equals the shared memory or FIFO data width.

You can use these blocks in the example design to read and write vectors of data samples to the MAC filter in a single software / hardware transaction.



17. Open `macfir_hw_w_frames_tb.mdl` from the MATLAB console.

This design is a very similar to the previous design, with a few modifications made to support the Shared Memory Read and Write blocks. Before simulating the design, you consider each of these modifications. Most importantly, Shared Memory Read and Write blocks have been substituted in place of the To and From FIFO testbench blocks in the previous design. By specifying CA and VA as the Write and Read shared memory names, respectively, an association is automatically made to the input and output FIFO buffers in the FPGA hardware during simulation.

A Simulink Buffer block builds a frame of scalar input samples by sequentially buffering the unfiltered input data. A simple analogy is that the Buffer block is performing a serial to parallel conversion. Recalling that you compiled the FIFO buffers with a depth of 4K, you choose a frame size of 4095.

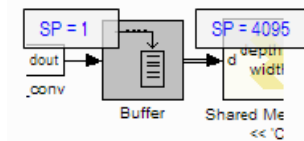

Note that the buffer block introduces a sample rate change in the design. For every 4095 inputs, there is only one output. Thus if the data input sample period is 1, the buffer data output sample period is 4095. This means that the Shared Memory Write block need only send a new frame of data to the FPGA on every 4095th simulation cycle (which is considerably more efficient than initiating a hardware transaction during every simulation cycle).

Because the Buffer block introduces a rate change, you must adjust the downstream blocks to accommodate the slower sample period. You begin by telling the Shared Memory Read block to read a frame of data every 4095th simulation cycle.

18. Double-click on the Shared Memory Read block to open its parameters dialog box.

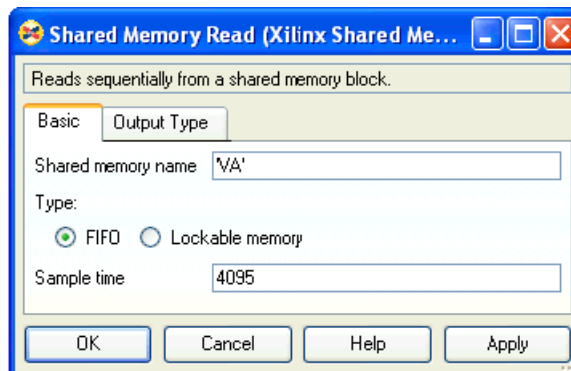

On the **Type** field under the **Basic** tab, you have configured the block to use shared FIFOs. To ensure a new frame is read at the appropriate time, you configure the Shared Memory Read block with a Sample time value of 4095.

The Shared Memory Read block allows you to specify the output data type and dimensions.

19. On the parameters dialog box, switch to the **Output Type** tab.

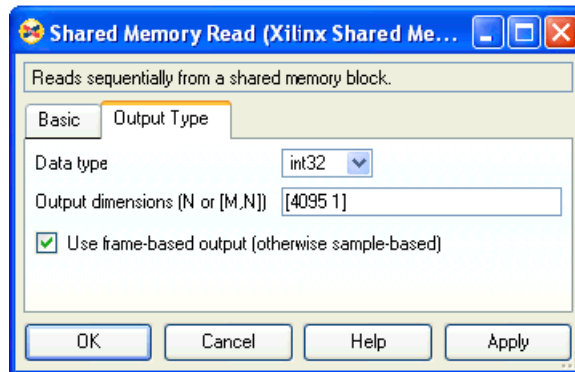

There are several things of interest on this tab. First, you set the output data type as an int32 to match the filter data path output width of 32-bits. Note the design will not simulate unless these widths match. Secondly, you choose an output dimension that is 4095 words deep in the Output dimensions field. Finally, you tell the block to generate frame-based output since frame data types are required by the downstream Unbuffer block.

20. Close the parameters dialog box.

The Simulink Unbuffer block takes the frame data from the Shared Memory Read block and deserializes it into sequential scalar values. The Simulink Unbuffer block also introduces a sample rate change in the diagram. Because the input sample period to the block is 4095, and the frame size is 4095 words, the Unbuffer block output sample period is 1. This works out nicely since you have data moving through the overall system at an effective sample period of 1.

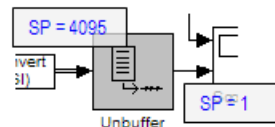

Because the Shared Memory Write and Read block operate on integer values, you must insert Simulink type conversion blocks into the diagram so that the data is interpreted correctly in various portions of the model. The `in_data_conv` subsystem converts the Simulink doubles into 16-bit integer values that can be interpreted appropriately by the FPGA hardware. On the output side, the `out_data_conv` subsystem converts the 32-bit integers into 32-bit Simulink fixed-precision values.

Before simulating the design, you must add the hardware co-simulation block you created from the previous design.

21. Add the hardware co-simulation block to the design as shown below.

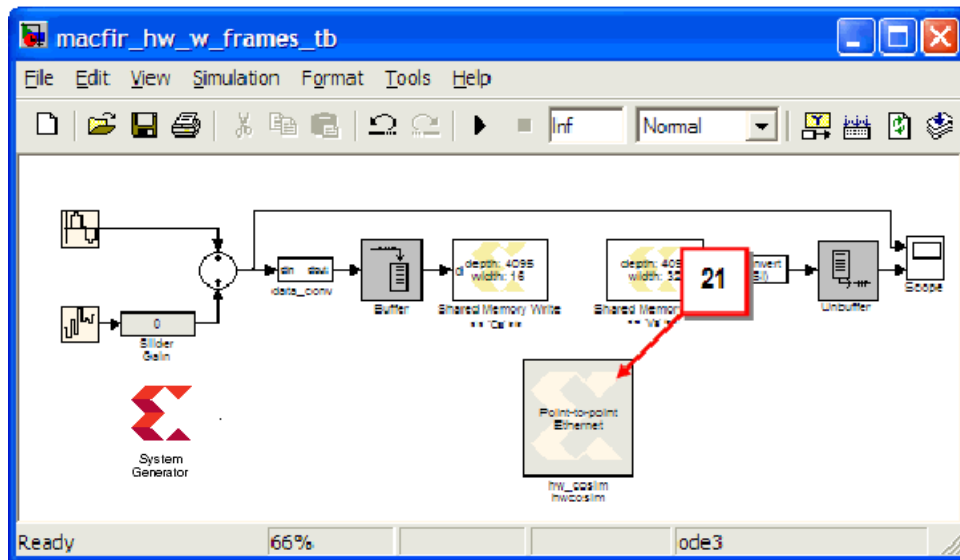

As mentioned before, the Shared Memory Write block writes a new input frame of 4095 words to the FPGA on every 4095th clock cycle. Likewise, the Shared Memory Read block reads an output frame of 4095 words from the FPGA on every 4095th clock cycle. This means that the FPGA must process the entire frame in a single-cycle. How exactly is this accomplished?

The first step is to configure the FPGA in free-running clock mode. In doing so, you allow the FPGA to process data considerably faster than if it were otherwise kept in lockstep with the Simulink simulation. Whereas in single-step mode the FPGA can only process one data per Simulink cycle, the FPGA processing speed is limited only by the system clock frequency when operating in free-running clock mode. Even so, if the buffer is large enough, the FPGA may not have time to process the complete buffer before the next block in the design is woken up. You still need a way to stall the rest of the simulation while the FPGA processes the entire buffer.

The Shared Memory Read block checks the number of FIFO words available in the output buffer before trying to read a frame. If the number of words in the buffer is insufficient, the Read block waits for a small amount of time, and then checks again to determine if the words have become available. It only reads the frame once all of the words are available in the output buffer, in this case 4095. In this manner, the Shared Memory Read block can stall the simulation until the complete frame has been processed by the FPGA.

The simulation flow of data through the diagram is shown below.

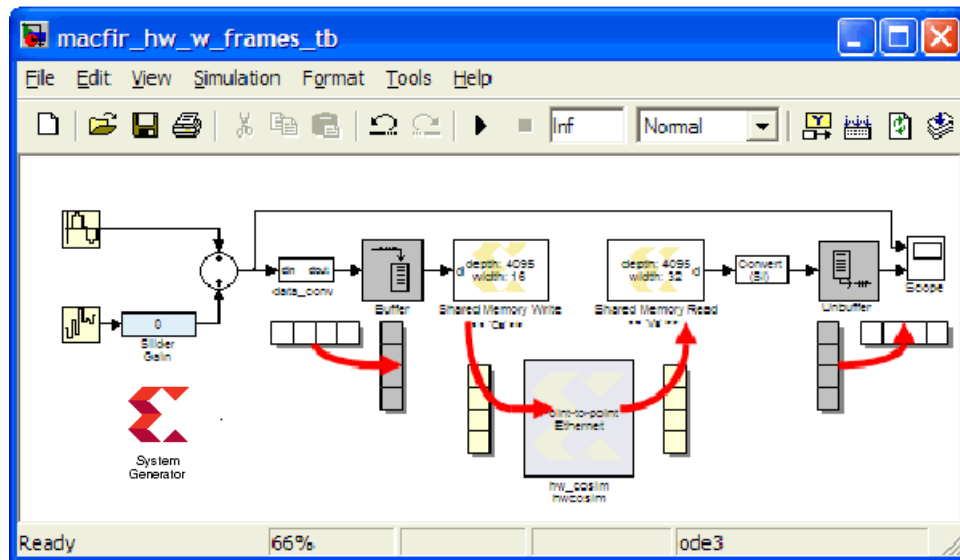

Two steps necessary to run the simulation using Simulink frames signals are provided below:

22. Double-click on the hardware co-simulation block to bring up the parameters dialog box.
23. Select Free running clock mode as shown below.

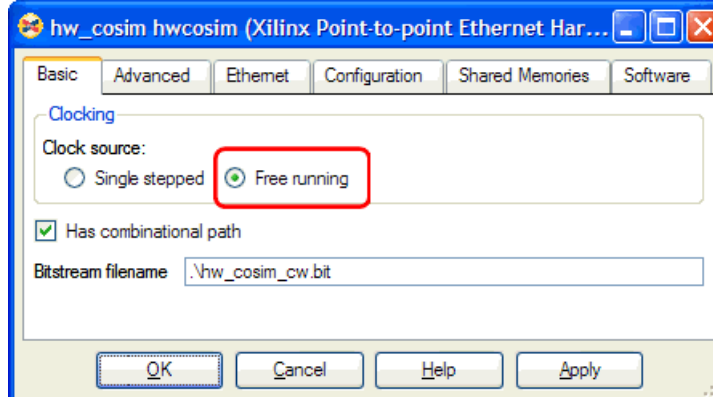

24. Configure the hardware co-simulation block with any additional settings necessary for simulation according to the requirements of your co-simulation board.
25. Press the Simulink **Start** button to start the design.
26. Record the amount of time required to simulate the design for 10000 cycles.

---

27. What is the simulation speed increase over the time recorded in step 15?

---

## Real-Time Signal Processing using Hardware Co-Simulation

The shared memory interfaces available in System Generator allow signal processing designs with high bandwidth and memory requirements to be co-simulated using FPGA hardware. When used in conjunction with the Xilinx Shared Memory Read and Write blocks, it is possible for hardware co-simulation designs to process complete Simulink vector and matrix signals in a single simulation cycle. These large data transactions between Simulink and the FPGA are realized using burst transfers, and depending on the co-simulation interface, often provide sufficient throughput for real-time signal processing applications.

There are two types of System Generator interfaces that support burst transfers when compiled into FPGA hardware. These interfaces include lockable shared memories and shared FIFO blocks. Both blocks provide different handshaking protocols that determine how and when transactions between the FPGA and host PC occur. Before using these blocks, it is useful to understand how they work in relation to hardware co-simulation. For more information, please refer to the following topics:

[Co-Simulating Lockable Shared Memories](#)

[Co-Simulating Shared FIFOs](#)

In this document, a high-speed co-simulation buffering interface implemented as a System Generator model is presented. The example interface uses lockable-shared memories to implement the required buffer storage. Note that it is relatively straightforward to modify the flow control logic so that shared FIFOs may be used in place of the shared memories.

The high-speed buffering interface is discussed first, followed by an example in which the interface is used to support real-time processing of a video stream using a 5x5 filter kernel. Described last is how an additional unprotected shared memory is applied to the system to support dynamic reloading of the image kernel during co-simulation.

### Shared Memory I/O Buffering Example

When a lockable shared memory is compiled for hardware co-simulation, additional circuitry is included in the FPGA to handle the mutual exclusion. Part of this circuitry includes logic to enable high-speed transfers of the memory image when the FPGA acquires or releases lock of the memory. It takes advantage of the lockable shared memory mutual exclusion semantics to implement a high-speed I/O buffering interface for hardware co-simulation. This topic describes this interface, which is included as an example model in your System Generator software installation.

1. From the MATLAB console, change directory to  
`<ISE_Design_Suite_tree>/sysgen/examples/shared_memory/hardware_cosim/io_bufferin`
2. Open `highspeed_iobuf_ex.mdl` from the MATLAB console.

The I/O buffering interface allows you to easily buffer and stream data through a System Generator signal processing data path during hardware co-simulation. The example design is comprised of two subsystems that implement input and output buffer storage, named Input Buffer and Output Buffer, respectively. The turquoise block in the center of the diagram is a placeholder for the signal processing data path which you will substitute into the design.

At the heart of each buffering subsystem is a lockable shared memory block that provides the buffer storage. Each shared memory is wrapped by logic that controls the flow of data

from the host PC, through the interface, and back to the host PC. Operation of the I/O buffering interface is shown in the flow chart below:

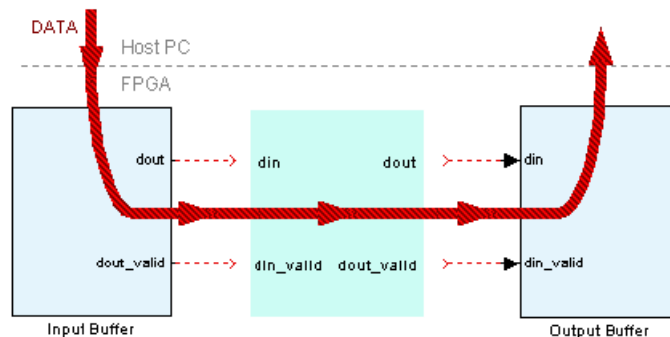
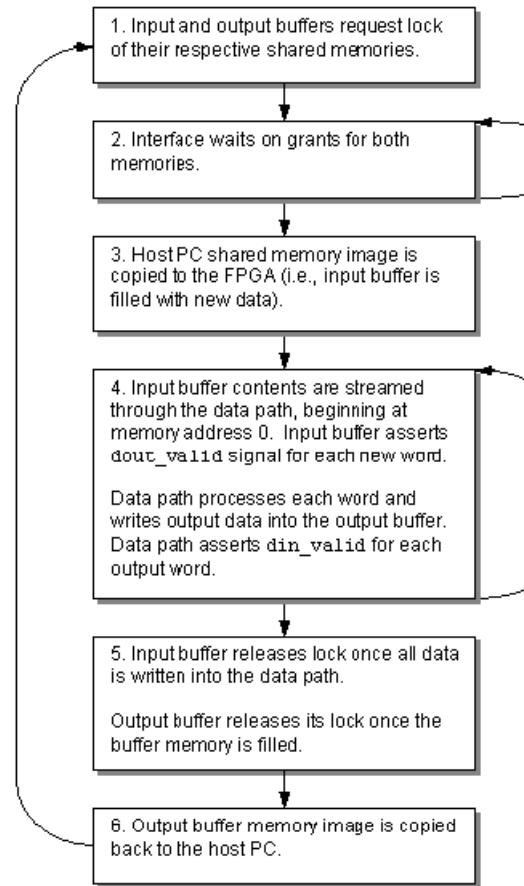

Notice that the buffering interface design includes several *data valid* ports. These ports are used for data flow control. A "true" output from the Input Buffer `dout_valid` port indicates new data is ready to be processed by the data path. Likewise, when the data path is finished processing the data, it should drive the Output Buffer subsystem's `din_valid` port to "true" to indicate valid output data (the `din_valid` port is analogous to a write enable control signal).

The example includes a placeholder that should be replaced by a System Generator data path. You may insert any data path in the buffer interface provided that it works within the valid signal semantics described above.

**Note:** The output buffer shared memory does not release lock until the output buffer is full. To avoid deadlock, the number of valid assertions by the data path should equal the output memory buffer size for a given processing cycle.

## Applying a 5x5 Filter Kernel Data Path

You will now apply a data path to the I/O buffering interface to demonstrate a complete system capable of processing a 128x128 8-bit grayscale video stream in real-time. You have chosen to use a 5x5 image processing kernel to implement the data path portion of the high-speed buffering interface. For more information about the filter kernel, refer to the System Generator demo entitled `sysgenConv5x5`. You begin by considering various aspects of the design implementation.

3. From the MATLAB console, change directory to  
`$SYSGEN/examples/shared_memory/hardware_cosim/conv5x5_video`.
4. Open `conv5x5_video_ex.mdl` from the MATLAB console.

## Buffer and Data Path Configuration

With the frame and pixel constraints in mind, the input and output buffer parameter dialog boxes are configured with a depth of 128x128 (16K) words and a word width of 8-bits. This depth allows the interface to process a complete frame in a single simulation cycle. Note that these configuration parameters are propagated automatically to the lockable shared memories that implement the buffer storage.

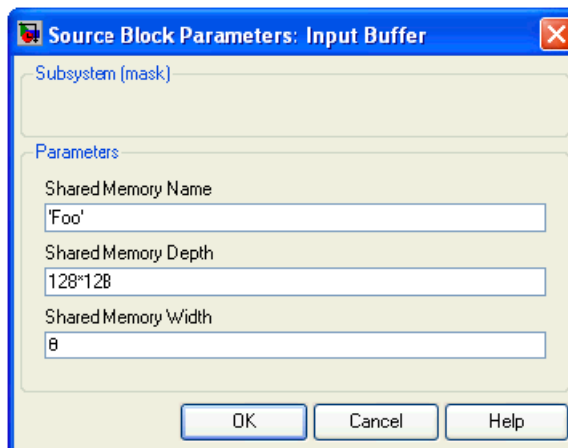

The data path uses line buffers to properly align data samples in the filter kernel. The size of these line buffers can be parameterized to accommodate different frame sizes. In this example, the line buffers are implemented in the Virtex2 5 Line Buffer block in the `conv5x5_video_ex/5x5_filter` subsystem, and are pre-configured with a line size of

128. If you decide to process a different size frame, the `Line Size` parameter should be updated accordingly.

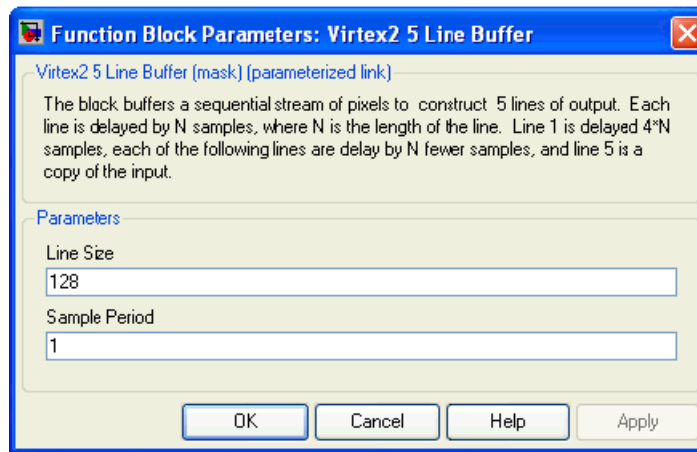

## Valid Bit Generation

The data path includes a subsystem named `valid_generator` that is responsible for driving the `din_valid` port of the output buffer block. The subsystem has two inputs, `valid_in` and `offset`. The `valid_in` port is driven by the `dout_valid` signal from the input buffer block, which is delayed by a variable number of cycles before it is driven to the `valid_out` port. The logic associated with the `valid_generator` subsystem is shown below.

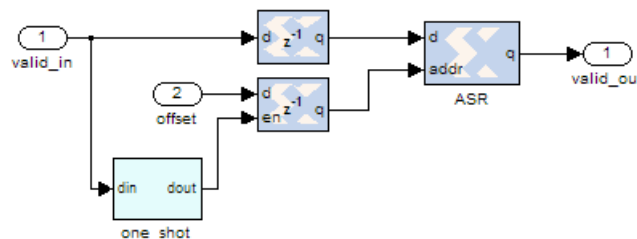

An addressable shift register block (ASR) is used to delay the valid bit. The `offset` port is used to control the address of the ASR block, which in turn controls the amount of latency the valid bit incurs. By simply delaying the valid bit generated by the input buffer block, you ensure the number of words written to the output buffer is always equal to the buffer size. Note that when the design is run in hardware, a change in the `offset` value will cause the vertical alignment of the filtered images to change.



## Support for Coefficient Reloading

An interesting characteristic of the kernel data path is that its coefficients can be dynamically reloaded at run-time. The 5x5 filter block includes Load and Coef control ports, which are driven by the `coefficient_memory` subsystem.

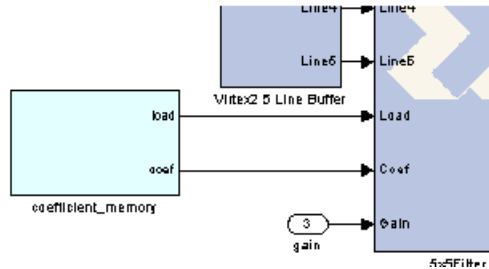

The `coefficient_memory` contains a copy of the most recently loaded filter coefficients, which are stored in an *unprotected* shared memory named `coef_buffer`. During run-time, the subsystem monitors the shared memory contents, and initiates a reload sequence if detects a change. By co-simulating the unprotected shared memory, any process on the host PC may write new kernel coefficients simply by writing to a shared memory object named `coef_buffer`. This interface is convenient, as communication with the FPGA hardware is completely abstracted through the Shared Memory API.

## Compiling for Hardware Co-simulation

The full filter kernel design must be compiled for hardware co-simulation before it can be simulated.

5. Double click on the System Generator token located at the top of the `conv5x5_video_ex` model.
6. Select an appropriate hardware co-simulation target.
7. Press the **Generate** button to compile the design for hardware co-simulation.

A hardware co-simulation block is created once the design finishes compiling.



Hardware co-simulation blocks include information about any shared memories, registers, or FIFOs that were compiled as part of the design. You may view this information by double-clicking on the hardware co-simulation block to open the parameters dialog box.

Once the dialog box is open, selecting the Shared Memories tab reveals information about each shared memory in the compiled design.

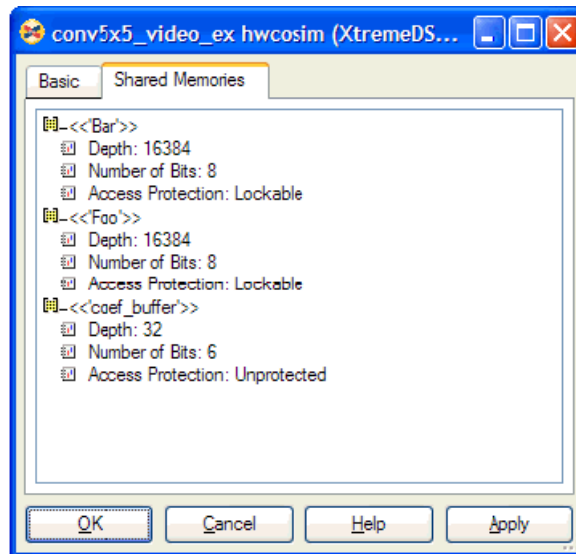

Go ahead and leave the hardware co-simulation library open. In the next topic you will include the hardware co-simulation block in a video processing testbench design.

## 5x5 Filter Kernel Test Bench

Included with the example files is a Simulink test bench model that uses the hardware co-simulation block to filter a looped video sequence.

8. From the

```
...sysgen/examples/shared_memory/hardware_cosim/conv5x5_video
directory, open conv5x5_video_testbench.mdl.
```

The testbench model uses a From Workspace block to produce the looped video sequence. Each frame of the video sequence is represented as a 128x128 uint8 Simulink matrix (a pre-load function loads and initializes the video sequence automatically when the model is opened). Video frames are written into the FPGA Processing subsystem where they are filtered at the rate of one frame per simulation cycle. The filtered output is then written to a Matrix Viewer block for analysis.

The FPGA Processing subsystem contains a stub for the hardware co-simulation block, as well as Shared Memory Read and Write blocks. In this example, the Shared Memory Read and Write blocks are responsible for managing video frame I/O to and from the shared memories operating inside the FPGA. The operation of these blocks is described below:

- a. The Shared Memory Write block wakes up and requests lock of the input buffer lockable shared memory Foo. Once lock is granted, the block writes the video frame data input into the lockable shared memory and releases lock.
- b. The hardware co-simulation block wakes up and requests lock of the input and output buffer shared memories Foo and Bar. The host PC shared memory images are transferred to the FPGA and lock is granted. The FPGA processes the input buffer data and writes the output into the output buffer. Lastly the FPGA releases

lock of Foo and Bar, causing the FPGA shared memory images to be transferred back to the host PC.

- c. The Shared Memory Read block wakes up and requests lock of the output buffer lockable shared memory Bar. The block reads a video from the output buffer and drives its output port with the processed video frame data.

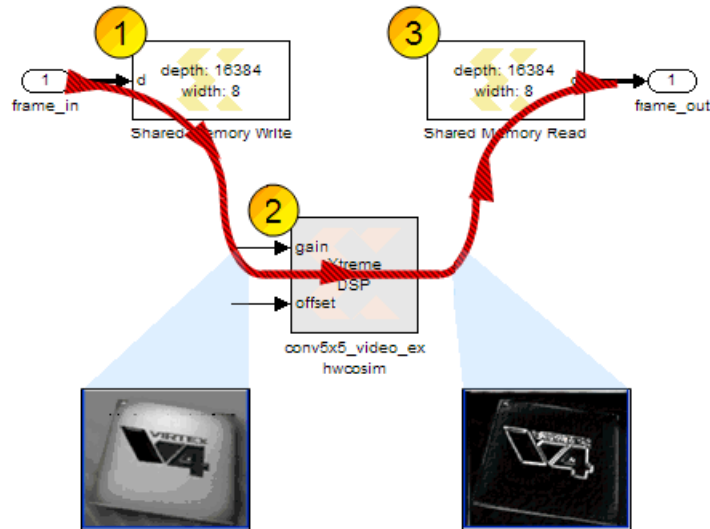

Note that the three steps listed above assume a specific sequencing of the hardware co-simulation and Shared Memory Read and Write blocks. To ensure these blocks are properly sequenced, you can set block priorities, where a lower priority block is woken up first during simulation.

9. Add the hardware co-simulation block to the testbench model in place of the turquoise placeholder residing in the FPGA Processing subsystem.

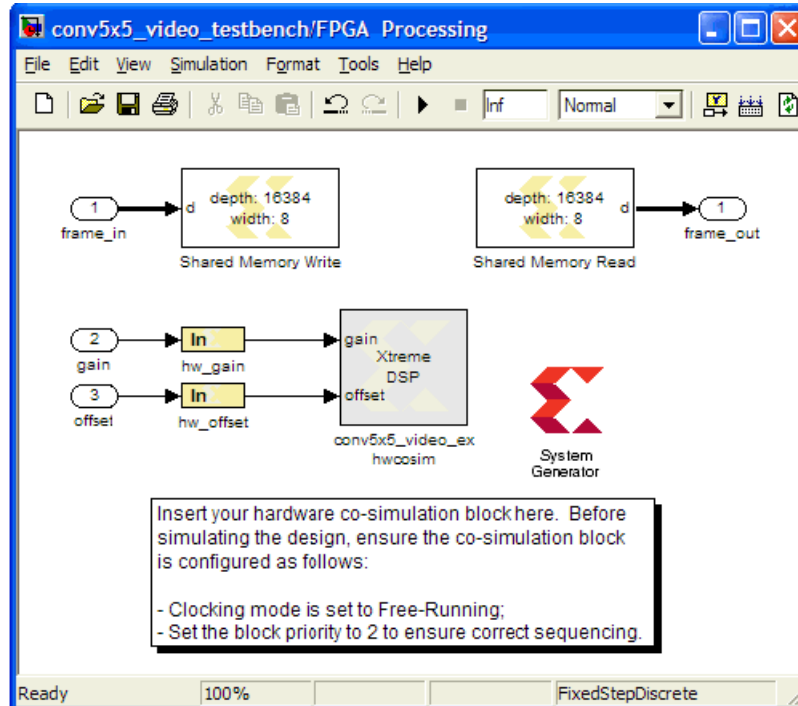

The Shared Memory Write block in the testbench is pre-configured with a priority of 1, and the Shared Memory Read block is pre-configured with a priority of 3. Since you want the hardware co-simulation block to wake up second in the simulation sequence, you must set the hardware co-simulation block priority to 2.

10. Right-click on the hardware co-simulation block, and select Block Properties.

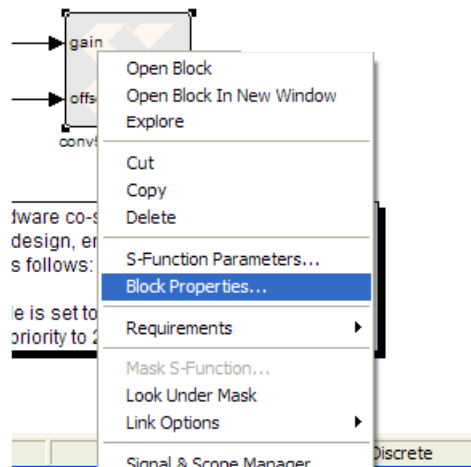

11. Specify a Priority of 2 in the Block Properties dialog box.



For high-speed processing applications, the hardware co-simulation block should be configured to operate in `Free Running` clock mode. When this mode is used, the synchronization between the FPGA and Simulink are handled entirely by the lockable shared memories. By running the FPGA in free-running mode, you allow it to run fast enough to process a complete video frame in a single Simulink cycle. Keep in mind that the hardware co-simulation block circuitry waits to acquire lock before processing data. Since the lock cannot be granted until the hardware co-simulation block is woken up, the FPGA sits idle until new data is presented in the input buffer.

12. Double-click on the hardware co-simulation block and choose a `Free Running Clock` under the `Basic` Tab.

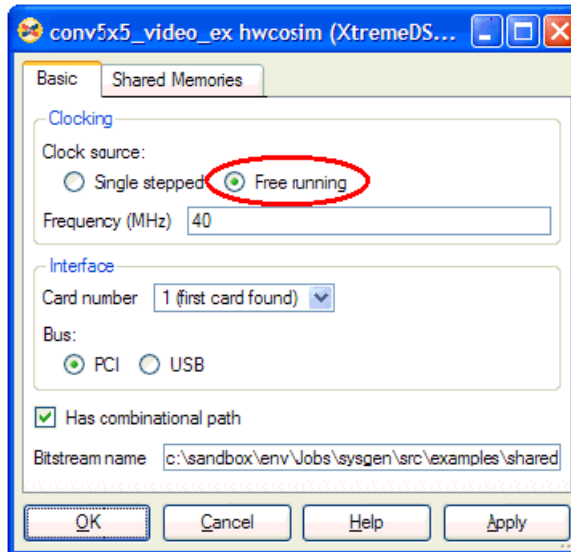

You are now ready to simulate the design.

13. Press the Simulink **Start** button to start simulation.

Two windows will appear showing the original and filtered video streams.

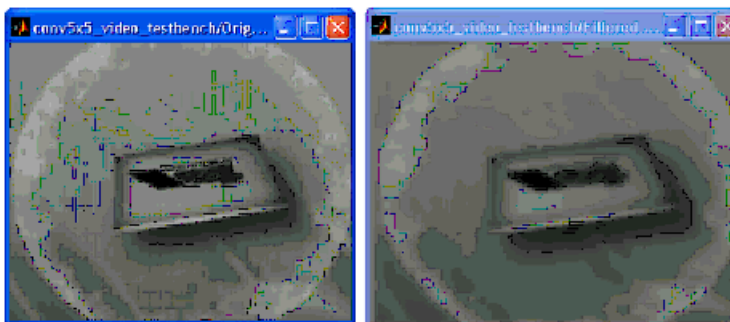

The left image is the original video frame. The image on the right is the same frame that has been processed using the "smooth" filter kernel. Note that the smoothing filter is just one of several filters that can be applied to the video source.

## Reloading the Kernel

The filter data path is designed so that the filter kernel can be reloaded dynamically while hardware co-simulation is running. Once the simulation is running, you may use the `xlReloadFilterCoef` function to load a new kernel. The function accepts a string kernel identifier (e.g., `sobelxy`) as an input parameter. A list of available filter kernels can be viewed by typing `help xlReloadFilterCoef` in the MATLAB console. The function is supplied as a MATLAB source file and can be found in the `$SYGEN/examples/shared_memory/hardware_cosim/conv5x5_video` directory.

**Note:** Once you have reloaded the filter, you may choose to adjust the coefficient gain. The gain can be adjusted using the Coefficient Adjust slider control at the top-level of the testbench model. This also demonstrates how System Generator's traditional, port-based, hardware co-simulation interfacing can be used in conjunction with the shared memory hardware co-simulation interfaces.

It is worthwhile to note that System Generator provides a MATLAB object interface to shared memory objects. The `xlReloadFilterCoef` function uses this object interface to write new coefficients into the unprotected shared memory named `coef_buffer` running in the FPGA. The function is fully annotated with comments that explain how the shared memory object is created, written to, and released when the operation is complete.

**Note:** The source code for the MATLAB object interface is supplied with the System Generator software installation, and can be found in the `$SYGEN/examples/shared_memory/mex_function` directory. Also included in this directory is MATLAB M-code that demonstrates how the mex-function source code was built.

14. After ensuring the testbench design is running, load the SobelXY filter kernel into the FPGA by typing `xlReloadFilterCoef('sobelxy')` from the MATLAB command window.

You will now see the video output generated using the SobelX-Y kernel.



## Installing Your Board for Ethernet Hardware Co-Simulation

**Note:** If installation instructions for your particular board are not provided here, please refer to the installation instructions that come with your Board Kit. For instructions on how to install a Xilinx USB Cable and cable driver software on a Windows or Linux Operating System, refer to the following document: [http://www.xilinx.com/support/documentation/user\\_guides/ug344.pdf](http://www.xilinx.com/support/documentation/user_guides/ug344.pdf)

### Installing Software on the Host PC

- Install Xilinx ISE® Design Suite software as described in the document: [ISE Design Suite Installation, Licensing, and Release Notes](#)
- Install WinPcap version 4.1.1 software, which may be obtained from the website at <http://www.winpcap.org>.
- Install the currently supported version of MATLAB®/Simulink software from The MathWorks. Refer to the System Generator for DSP Release Information for the currently supported version of MATLAB.

### Setting Up the Local Area Network on the PC

For Ethernet Point-to-Point Hardware Co-Simulation, you are required to have a 10/100 Fast Ethernet or a Gigabit Ethernet Adapter on your PC. To configure the settings do the following:

1. As shown below, from the **Start** menu, select **Control Panel**, then right-click on **Local Area Connection**, then select **Properties**.

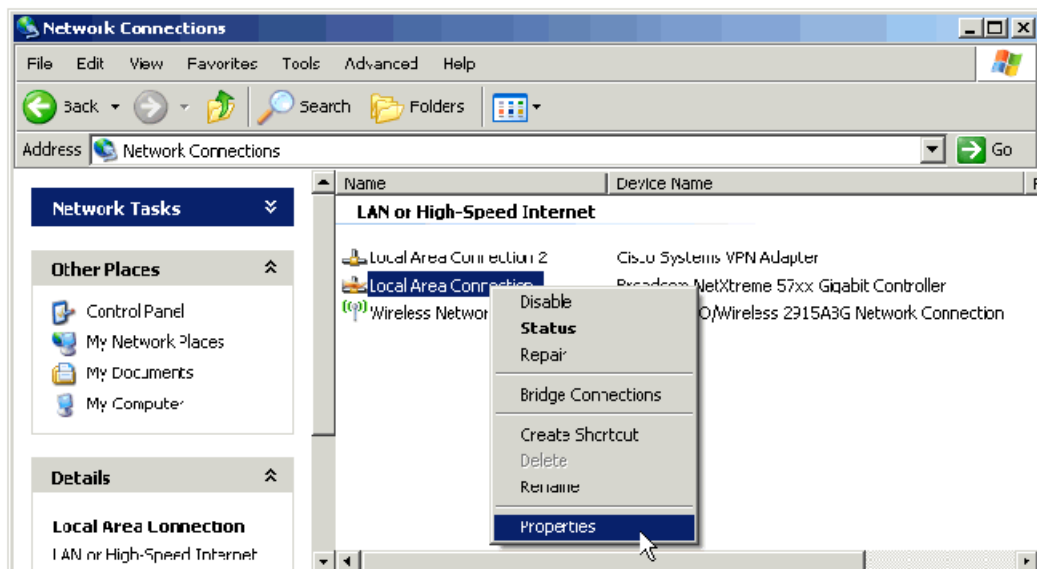

- As shown below, select **Internet Protocol (TCP/IP)**, then click on the **Properties** button and set the IP Address 192.168.8.2 and Subnet mask to 255.255.255.0. (The last digit of the IP Address must be something other than 1, because 192.168.8.1 is the default IP address for the board.

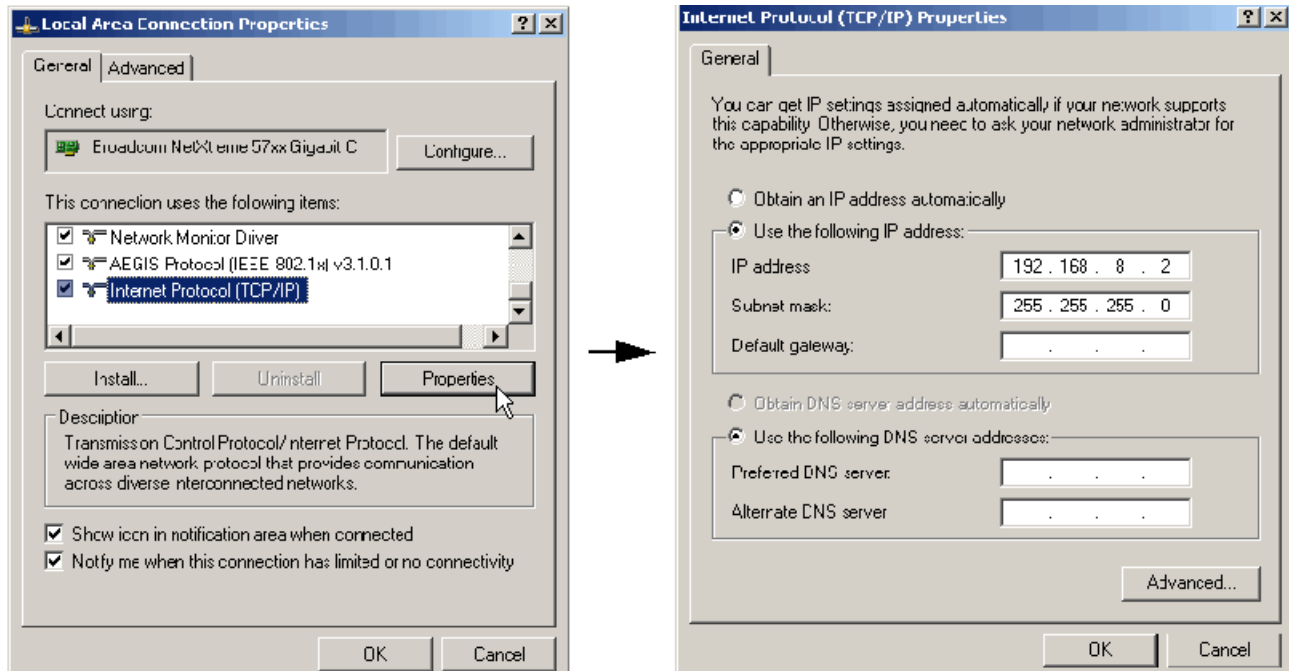

- Click on the **Configure** button, select the **Advanced** tab, select **Flow Control**, then select **Auto**.

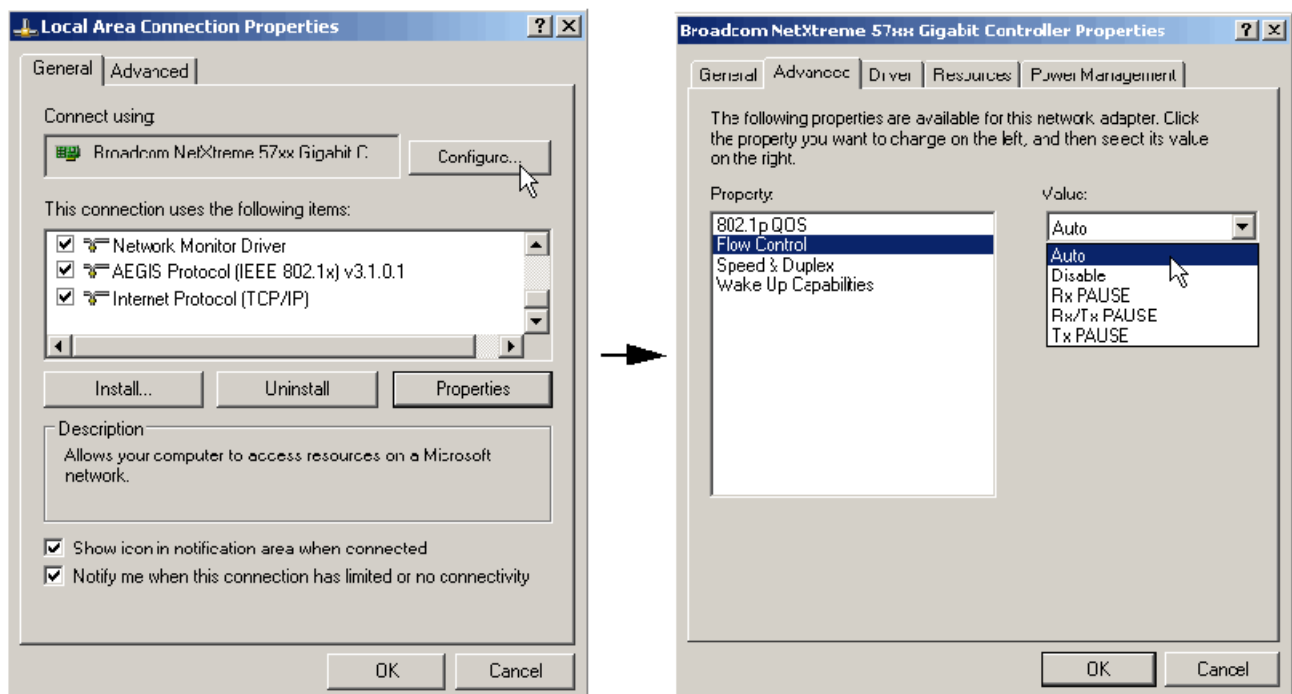



4. Set **Speed & Duplex** to **Auto**, then click out using the OK button.

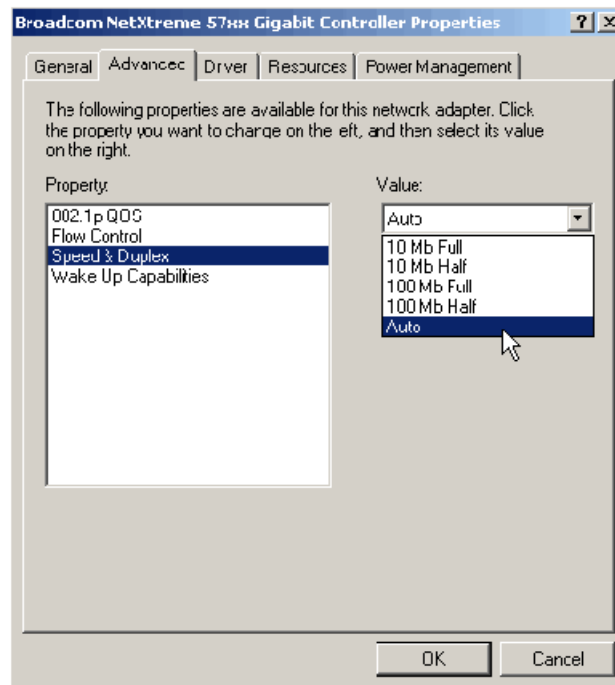

## Loading the Sysgen HW Co-Sim Configuration Files

**Note:** The following instructions apply only to boards that support Ethernet-based hardware configuration. These boards include: ML402, ML506, and Spartan-3A DSP 3400.

System Generator comes with HW Co-Sim configuration files that first need to be loaded into the CompactFlash card with a CompactFlash Reader.

1. Optionally Backup the Demo Files

The CompactFlash card comes with a series of demo files that you might want to re-load and exercise later.

- a. Connect the CompactFlash Reader to the PC. This is usually done through a USB port.
- b. Insert the CompactFlash card into a CompactFlash Reader.
- c. Click on the MyComputer icon, then select the Removable Disk drive that represents the CompactFlash Reader.
- d. Create or open a backup folder on the PC and copy the content of the CompactFlash card to that folder for later use.

**Note:** For the following steps, 'e:' is assumed to be the drive name associated with the CompactFlash reader.

2. Re-Format the CompactFlash Card

The card needs to be re-formatted to a FAT16 file system before the System Generator files can be transferred. You use the `mkdosfs` utility to format the card.

- a. Download the `mkdosfs` program from the Xilinx URL address:  
<http://www.xilinx.com/products/boards/ml310/current/utilities/mkdosfs.zip>.
- b. Extract to folder `C:/mkdosfs`

- c. Open a Windows shell by selecting **Start > Run...**, then type `cmd` in the Run dialog box and click **OK**.
- d. In the shell, move to the `mkdosfs` folder:

```
cd C:\mkdosfs
```

**Caution!** In the following step, make sure the drive name (e.g., 'e:' in this case) is specified correctly for the Compact Flash Removable Disk. Otherwise, the information on the mistakenly targeted drive will be erased and the drive will be re-formatted.

- e. Type the following `mkdosfs` command after the Windows command prompt:

```
mkdosfs -v -F 16 e:
```

The content of the Compact Flash card should be wiped clean and re-formatted.

3. Copy the Sysgen configuration files to the Compact Flash card

**Note:** For reference, the Sysgen files to be copied are located at the following pathname:

For ML402:

```
...<ISE_Design_Suite_tree>/sysgen/plugins/bin/ML402_sysace_cf.zip
```

For ML506:

```
...<ISE_Design_Suite_tree>/sysgen/plugins/bin/ML506_sysace_cf.zip
```

For Spartan-3A DSP 3400:

```
...<ISE_Design_Suite_tree>/sysgen/plugins/bin/S3ADSP_DB_sysace_cf.zip
```

Invoke MATLAB on the PC, then enter the following command on the MATLAB Command Line. The command for ML402 is illustrated:

```
unzip(fullfile(xilinx.environment.getpath('sysgen'),'plugins/bin/ML402_sysace_cf.zip'),'e:/')
```

The following files and folder should now be listed on the CompactFlash drive:

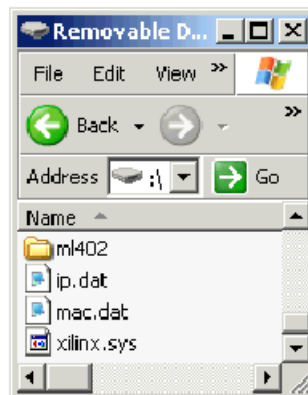

### Optional Step to Set the Ethernet MAC Address and the IPv4 Address

**Note:** The following step may be necessary if the default MAC and IP addresses conflict with your default network settings, or if you wish to co-simulate two or more boards concurrently. If not, proceed to the next topic.

After writing the data to the card, you will find two files, `mac.dat` and `ip.dat`, in the card root directory. The `mac.dat` and `ip.dat` files specify the Ethernet MAC address and IPv4 address associated with the board, respectively. These addresses are used to uniquely identify a target board during Ethernet hardware co-simulation.

- a. Open `mac.dat` in a text editor and change the Ethernet MAC address. The MAC address must be specified as a six pair of two-digit hexadecimal separated by colons (e.g. `00:0a:35:11:22:33`). All-zeros, broadcast, or multicast MAC addresses are not supported.

- b. Open `ip.dat` in a text editor and change the IP address. The IP address must be specified in IPv4 dotted decimal notation (e.g. `192.168.8.1`). All-zeros, broadcast, multicast, or loop-back IP address are not supported. After changing the IP address for the board, update the IP address for the network connection on the PC accordingly as mentioned in topic [Setting Up the Local Area Network on the PC](#). For a direct connection, the board and the PC must be on the same subnet. Otherwise, the board IP address should be reachable from the PC and vice versa.

## Installing the Proxy Executable for Linux Users

Running hardware co-simulation on a Linux machine requires that you first run a shell script that installs a proxy executable. Do the following:

1. Log into the root account on your Linux machine
2. Go to the bin directory where System Generator is installed. For example,  

```
cd $XILINX_DSP/sysgen/bin
```
3. Run the shell script called `install_pcap_proxy.sh`. For example, at the shell command line type:  

```
./install_pcap_proxy.sh
```

## Installing an ML402 Board for Ethernet Hardware Co-Simulation

The following procedure describes how to install and configure the hardware and software required to run Ethernet Hardware Co-Simulation on an ML402 board.

### Assemble the Required Hardware

1. Xilinx Virtex®-4 SX ML402 board which includes the following:
  - a. Virtex®-4 ML402 board
  - b. 5V Power Supply bundled with the ML402 Kit
  - c. CompactFlash Card
2. You also need the following items on hand:
  - a. Ethernet network Interface Card (NIC) for the host PC.
  - b. Ethernet RJ45 Male/Male cable. (May be a Network or Crossover cable.)
  - c. CompactFlash Reader for the PC.

### Setup the PC

1. Install the related software on the PC as described in the topic [Installing Software on the Host PC](#).
2. Setup the Local Area Network as described in the topic [Setting Up the Local Area Network on the PC](#).

### Load the Sysgen ML402 HW Co-Sim Configuration Files

System Generator comes with HW Co-Sim configuration files that first need to be loaded into the ML402 CompactFlash card. Follow the instructions that are described in the topic [Loading the Sysgen HW Co-Sim Configuration Files](#).

## Setup the ML402 board

The figure below illustrates the ML402 components of interest in this setup procedure:

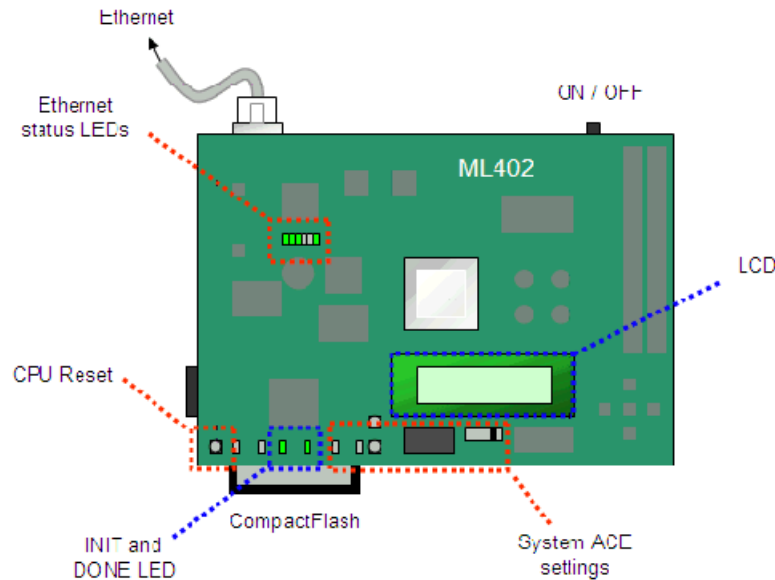

1. Position the ML402 board so the Virtex®-4 and Xilinx logos are oriented near the top edge of the board.
2. Make sure the power switch, located in the upper-right corner of the board, is in the **OFF** position.
3. As shown below, **Eject** the CompactFlash card from the CompactFlash Reader.

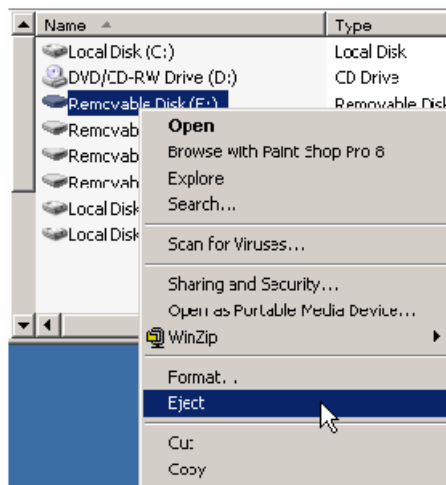

4. Remove the CompactFlash card from the CompactFlash Reader.
5. Locate the CompactFlash card slot (on the back side of the ML402 board), and carefully insert the CompactFlash card with its front label facing away from the board. The figure below shows the back side of the board with the CompactFlash card properly inserted.

**Note:** The CompactFlash card provided with your board might differ.

**Caution!** Be careful when inserting or removing the CompactFlash card from the slot. Do not force it.



6. Connect the AC power cord to the power supply brick. Plug the power supply adapter cable into the ML402 board. Plug in the power supply to AC power.

**Caution!** Make sure you use an appropriate power supply with correct voltage and power ratings.

7. Using the RJ45 Male/Male Ethernet Cable, connect the Ethernet connector on the ML402 board directly to the Ethernet connector on the host PC.
8. Set the Configuration Address DIP Switches.

As shown below, set the Configuration Address DIP Switches as follows: **1:on, 2:off, 3:off, 4:on, 5:off, 6:on]**

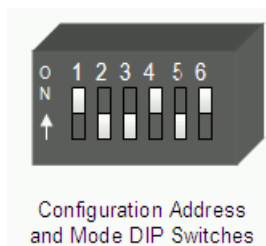

9. Set the Configuration Source Selector Switch.

As shown below, set the Configuration Source Selector Switch to **SYS ACE**

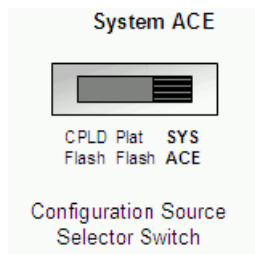

#### 10. Verify the Configuration Settings

- a. Turn the target board Power switch **ON**.
- b. Check the on-board status LEDs to ensure the FPGA is configured. If the configuration succeeded, the **DONE** LED should be on and all error LEDs should be off.
- c. As shown below, check the information displayed on the 16-character 2-line LCD screen of the board. If no error occurred, the Ethernet MAC address (without colons) should appear on the first line of the display and the IPv4 address should appear on the second line.

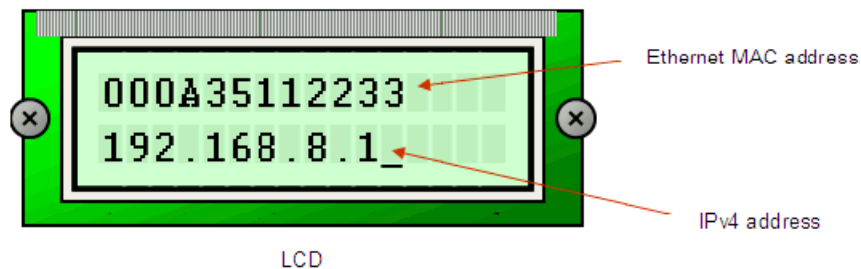

- d. If the LCD display does not show the information correctly, press the System ACE™ Reset button to reconfigure the FPGA.
  - e. Check the status LEDs again to ensure the configuration sequence completed successfully.
- #### 11. Verify the Ethernet Interface and Connection Status
- a. Connect the Ethernet interface of the board to a network connection, or directly to a host.
  - b. Check the on-board Ethernet status LEDs to make sure the Ethernet interface is attached to an active Ethernet segment. The LEDs should reflect the link speed and the duplex mode at which the interface is operating. The TX and RX leds should flash on and off occasionally depending on the network traffic. If no LED is on, press the **CPU Reset** button to reset the FPGA, and also examine whether the Ethernet segment is active.



Ethernet status LEDs

- c. To ensure the board is reachable by the host, issue ICMP ping from the host to check the connectivity. For example, type "ping 192.168.8.1" on a console to test the connectivity to a board with IP address 192.168.8.1.

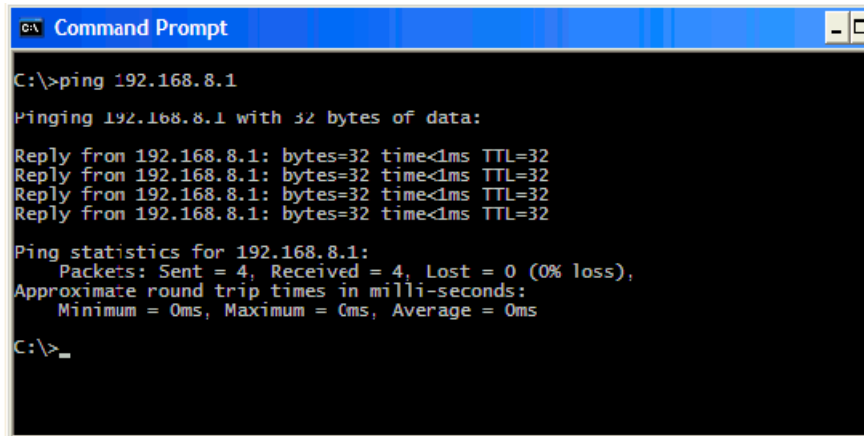

```
C:\> Command Prompt
C:\>ping 192.168.8.1
Pinging 192.168.8.1 with 32 bytes of data:
Reply from 192.168.8.1: bytes=32 time<1ms TTL=32
Reply from 192.168.8.1: bytes=32 time<1ms TTL=32
Reply from 192.168.8.1: bytes=32 time<1ms TTL=32
Reply from 192.168.8.1: bytes=32 time<1ms TTL=32
Ping statistics for 192.168.8.1:
    Packets: Sent = 4, Received = 4, Lost = 0 (0% loss),
    Approximate round trip times in milli-seconds:
        Minimum = 0ms, Maximum = 0ms, Average = 0ms
C:\>
```

- d. The target FPGA listens on the UDP port 9999. Please ensure the underlying network does not block the associated traffic when network-based Ethernet configuration is used. This does not affect point-to-point Ethernet configuration.

## Installing an ML506 Board for Ethernet Hardware Co-Simulation

The following procedure describes how to install and configure the hardware and software required to run an ML506 board Point-to-Point Ethernet Hardware Co-Simulation.

### Assemble the Required Hardware

1. Xilinx Virtex®-5 SX ML506 board which includes the following:
  - a. Virtex-5 ML506 board
  - b. 5V Power Supply bundled with the ML506 kit
  - c. CompactFlash Card
2. You also need the following items on hand:
  - a. Ethernet network Interface Card (NIC) for the host PC.
  - b. Ethernet RJ45 Male/Male cable. (May be a Network or Crossover cable.)
  - c. CompactFlash Reader for the PC.

### Install Related Software

Install the related software on the PC as described in the topic [Installing Software on the Host PC](#).

### Setup the Local Area Network

Set up the Local Area Network on your PC as described in the topic [Setting Up the Local Area Network on the PC](#).

### Load the Sysgen ML506 HW Co-Sim Configuration Files

System Generator comes with HW Co-Sim configuration files that first need to be loaded into the ML506 CompactFlash card. Follow the instructions that are described in the topic [Loading the Sysgen HW Co-Sim Configuration Files](#).



## Setup the ML506 board

The figure below illustrates the ML506 components of interest in this setup procedure:

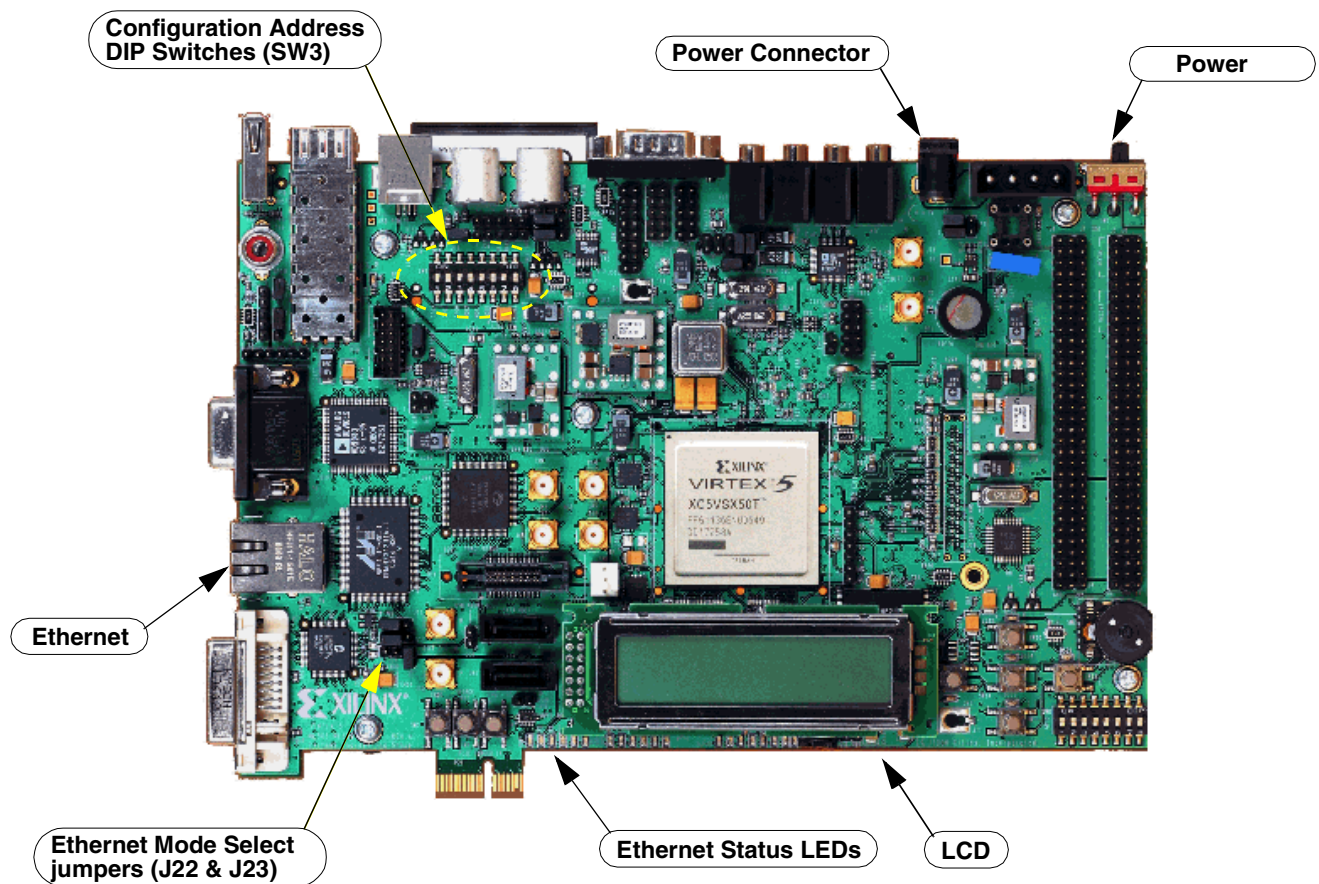

1. Position the ML506 board so the Xilinx logo is oriented near the lower-left corner.
2. Make sure the power switch, located in the upper-right corner of the board, is in the OFF position.

- As shown below, **Eject** the CompactFlash card from the CompactFlash Reader.

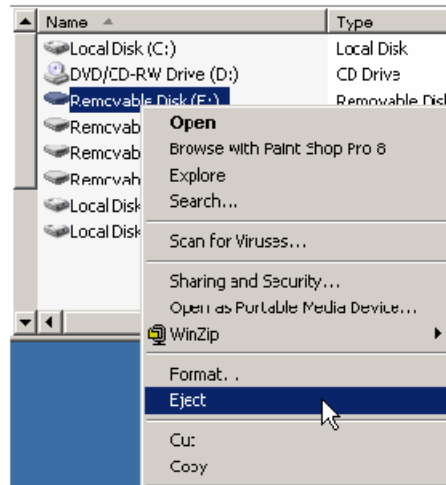

- Remove the CompactFlash card from the CompactFlash Reader.
- Locate the CompactFlash card slot (on the back side of the ML506 board), and carefully insert the CompactFlash card with its front label facing away from the board. The figure below shows the back side of the board with the CompactFlash card properly inserted.

**Note:** The CompactFlash card provided with your board might differ.

**Caution!** Be careful when inserting or removing the CompactFlash card from the slot. Do not force it.



- Connect the AC power cord to the power supply brick. Plug the 5V power supply adapter cable into the ML506 board. Plug in the power supply to AC power.
 

**Caution!** Make sure you use an appropriate power supply with correct voltage and power ratings.
- Using the RJ45 Male/Male Ethernet Cable, connect the Ethernet connector on the ML506 board directly to the Ethernet connector on the host PC.

8. Set the SW3 Configuration Address DIP Switches.

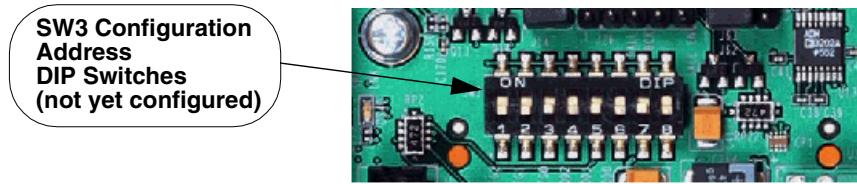

Set the Configuration Address DIP Switches as follows:

**1:on, 2:off, 3:off, 4:on, 5:off, 6:on, 7:off, 8:on**

9. Set the Ethernet Mode Select jumpers

As shown below, connect pin 1 and 2 on both the Ethernet Mode Select jumpers (J22 and J23)

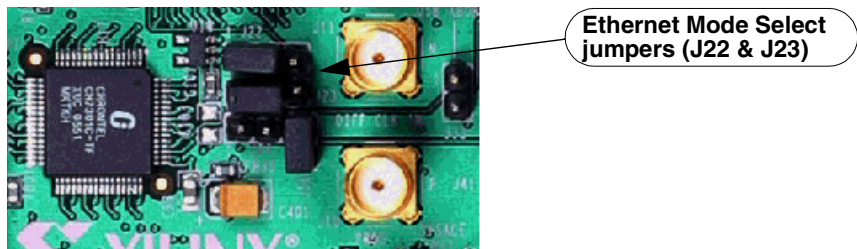

10. Verify the Configuration Settings

- a. Turn the target board Power switch ON.
- b. Check the on-board status LEDs to ensure the FPGA is configured. If the configuration succeeded, the **DONE** LED should be on and all error LEDs should be off.
- c. As shown below, check the information displayed on the 16-character 2-line LCD screen of the board. If no error occurred, the Ethernet MAC address (without colons) should appear on the first line of the display and the IPv4 address should appear on the second line.

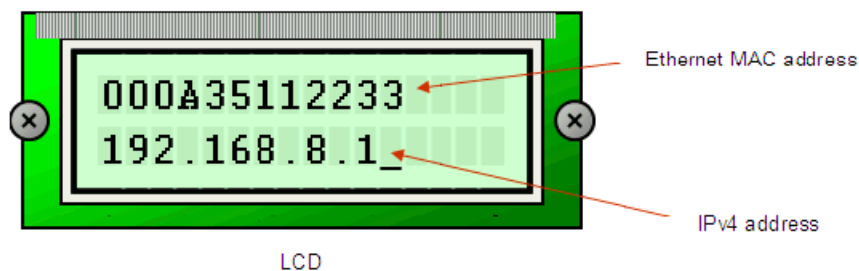

- d. If the LCD display does not show the information correctly, press the System ACE™ Reset button to reconfigure the FPGA.

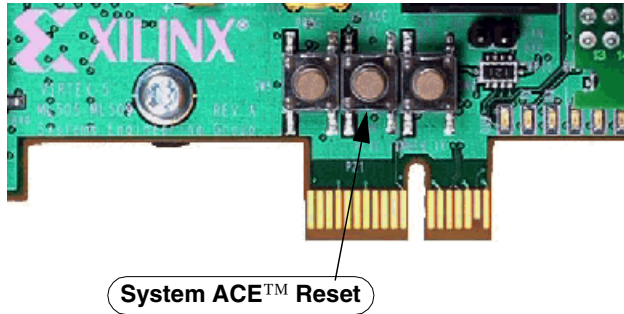

- e. Check the status LEDs again to ensure the configuration sequence completed successfully.
11. Verify the Ethernet Interface and Connection Status
    - a. Connect the Ethernet interface of the board to a network connection, or directly to a host.
    - b. Check the on-board Ethernet status LEDs to make sure the Ethernet interface is attached to an active Ethernet segment. The LEDs should reflect the link speed and the duplex mode at which the interface is operating. The TX and RX leds should flash on and off occasionally depending on the network traffic. If no LED is on, press the **CPU Reset** button to reset the FPGA, and also examine whether the Ethernet segment is active.



Ethernet status LEDs

- c. To ensure the board is reachable by the host, issue ICMP ping from the host to check the connectivity. For example, type "ping 192.168.8.1" on a console to test the connectivity to a board with IP address 192.168.8.1.

```

C:\> Command Prompt
C:\> ping 192.168.8.1
Pinging 192.168.8.1 with 32 bytes of data:
Reply from 192.168.8.1: bytes=32 time<1ms TTL=32
Reply from 192.168.8.1: bytes=32 time<1ms TTL=32
Reply from 192.168.8.1: bytes=32 time<1ms TTL=32
Reply from 192.168.8.1: bytes=32 time<1ms TTL=32
Ping statistics for 192.168.8.1:
    Packets: Sent = 4, Received = 4, Lost = 0 (0% loss),
    Approximate round trip times in milli-seconds:
        Minimum = 0ms, Maximum = 0ms, Average = 0ms
C:\> _
  
```

- d. The target FPGA listens on the UDP port 9999. Please ensure the underlying network does not block the associated traffic when network-based Ethernet configuration is used. This does not affect point-to-point Ethernet configuration.



## Installing an ML605 Board for Ethernet Hardware Co-Simulation

The following procedure describes how to install and configure the hardware and software required to run an ML605 board Point-to-Point Ethernet Hardware Co-Simulation.

### Assemble the Required Hardware

1. Xilinx Virtex®-6 LX ML605 board which includes the following:
  - a. Virtex-6 ML605 board
  - b. 12V Power Supply bundled with the ML605 kit
2. You also need the following items on hand:
  - a. Ethernet network Interface Card (NIC) for the host PC.
  - b. Ethernet RJ45 Male/Male cable. (May be a Network or Crossover cable.)

### Install Related Software

Install the related software on the PC as described in the topic [Installing Software on the Host PC](#).

### Setup the Local Area Network

1. Set up the Local Area Network on your PC as described in the topic [Setting Up the Local Area Network on the PC](#).

### Setup the ML605 board

The figure below illustrates the ML605 components of interest in this setup procedure:

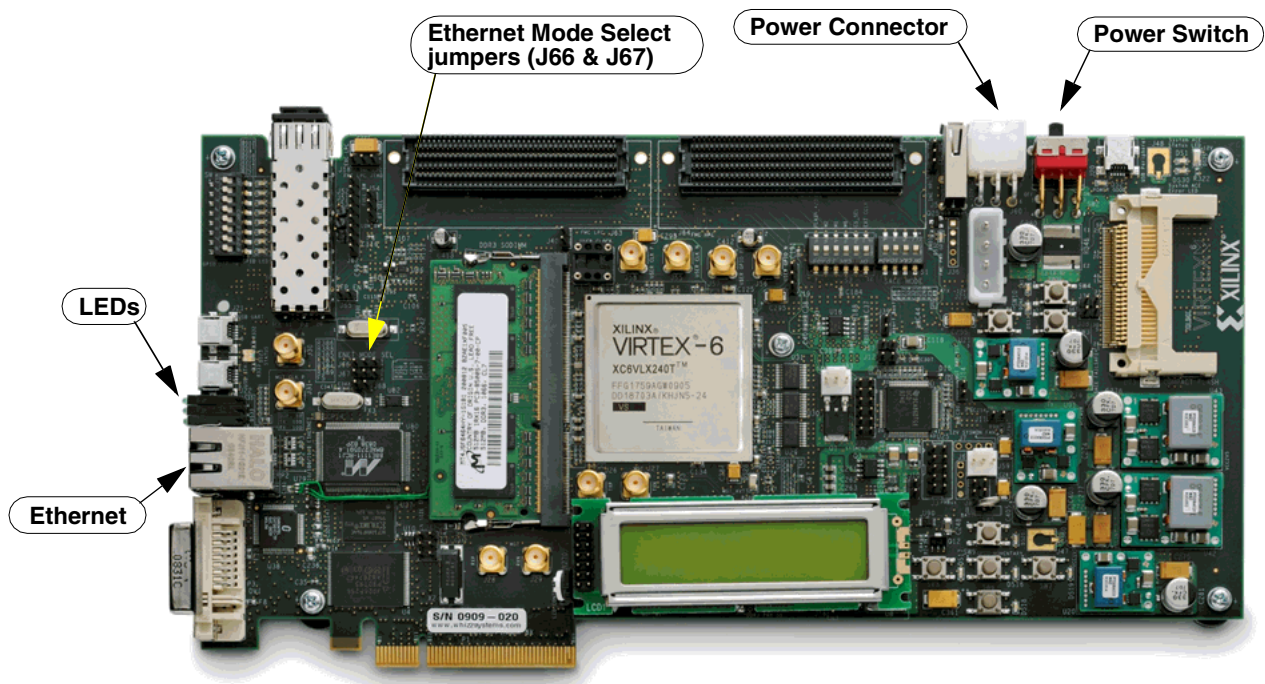

1. Position the ML605 board so the Xilinx logo is oriented near the lower-left corner.

2. Make sure the power switch, located in the upper-right corner of the board, is in the **OFF** position.
3. Connect the AC power cord to the power supply brick. Plug the 12V power supply adapter cable into the ML605 board. Plug in the power supply to AC power.  
**Caution!** Make sure you use an appropriate power supply with correct voltage and power ratings.
4. Using the RJ45 Male/Male Ethernet Cable, connect the Ethernet connector on the ML605 board directly to the Ethernet connector on the host PC.

## Installing a Spartan-3A DSP 1800A Starter Board for Ethernet Hardware Co-Simulation

The following procedure describes how to install and setup the hardware and software required to run Hardware Co-Simulation on a Spartan-3A DSP 1800A Starter Board. This board uses a JTAG cable instead of System ACE™ to download the configuration bitstream.

### Assemble the Required Hardware

1. Xilinx Spartan-3A DSP 1800A Starter Board which includes the following:
  - a. Spartan-3A DSP 1800A Starter Board
  - b. 5V Power Supply bundled with the development kit
2. You also need the following items on hand:
  - a. Ethernet network Interface Card (NIC) for the host PC.
  - b. Ethernet RJ45 Male/Male cable. (May be a Network or Crossover cable.)
  - c. Xilinx Parallel Cable IV with associated Power Jack splitter cable or a Xilinx Platform USB Cable and a 14-pin ribbon cable.

### Install Related Software

Install the related software on the PC as described in the topic [Installing Software on the Host PC](#).

### Setup the Local Area Network

1. Set up the Local Area Network on your PC as described in the topic [Setting Up the Local Area Network on the PC](#).

### Setup the Spartan-3A DSP 1800A Starter Board

1. Position the Spartan-3A DSP 1800A Starter Board so the Xilinx logo is oriented rightside up and located in the lower-right quadrant of the board.
2. Make sure the power switch, located in the upper-right corner of the board, is in the **OFF** position.
3. If you are using a Xilinx Parallel Cable IV, follow steps 3a through 3d.
  - a. Connect the DB25 Plug Connector on the Xilinx Parallel Cable IV to the IEEE-1284 compliant PC Parallel (Printer) Port Connector.
  - b. Using the narrow (14 pin) 6" High Performance Ribbon cable, connect the pod end of the Xilinx Parallel Cable IV to the **JTAG Port (J2)** on the Starter Board.
  - c. Connect the attached Power Jack cable to the Keyboard/Mouse connector on the PC.
  - d. If necessary, connect the male end of the Keyboard/Mouse cable to the associated female connector on the Xilinx Power Jack cable (splitter cable).
4. If you are using a Xilinx Platform Cable USB, follow step 4a and 4b.
  - a. Connect the Xilinx Platform Cable USB to a USB port on the PC.
  - b. Using the narrow (14 pin) 6" High Performance Ribbon cable, connect the pod end of the Xilinx Platform Cable USB to the **JTAG Port (J2)** on the Starter Board.

5. Connect the AC power cord to the power supply brick. Plug the 5V power supply adapter cable into the 5V DC ONLY connector (J5) on the Starter Board. Plug the power supply cord into AC power.  
**Caution!** Make sure you use an appropriate power supply with correct voltage and power ratings.
6. Turn the Spartan-3A DSP 1800A Starter Board POWER switch ON.

## Installing a Spartan-3A DSP 3400A Board for Ethernet Hardware Co-Simulation

The following procedure describes how to install and configure the hardware and software required to run an Spartan-3A DSP 3400A Development Board Point-to-Point Ethernet Hardware Co-Simulation.

### Assemble the Required Hardware

1. Xilinx Spartan-3A DSP 3400A Development Board Kit which includes the following:
  - a. Spartan-3A DSP 3400A Development Board
  - b. +12V Power Supply bundled with Board LYR178-101C (Rev C) or +5 V Power Supply bundled with Board LYR178-101D (Rev D)
  - c. CompactFlash Card
2. You also need the following items on hand:
  - a. Ethernet network Interface Card (NIC) for the host PC.
  - b. Ethernet RJ45 Male/Male cable. (May be a Network or Crossover cable.)
  - c. CompactFlash Reader for the PC.

### Install Related Software

Install the related software on the PC as described in the topic [Installing Software on the Host PC](#).

### Load the Sysgen Spartan-3A DSP 3400A HW Co-Sim Configuration Files

System Generator comes with HW Co-Sim configuration files that first need to be loaded into the Spartan-3A DSP 3400 CompactFlash card. Follow the instructions that are described in the topic [Loading the Sysgen HW Co-Sim Configuration Files](#).



### Setup the Spartan-3A 3400A Development Board

The figure below illustrates the Spartan-3A 3400A Board (Rev C) components of interest in this setup procedure:

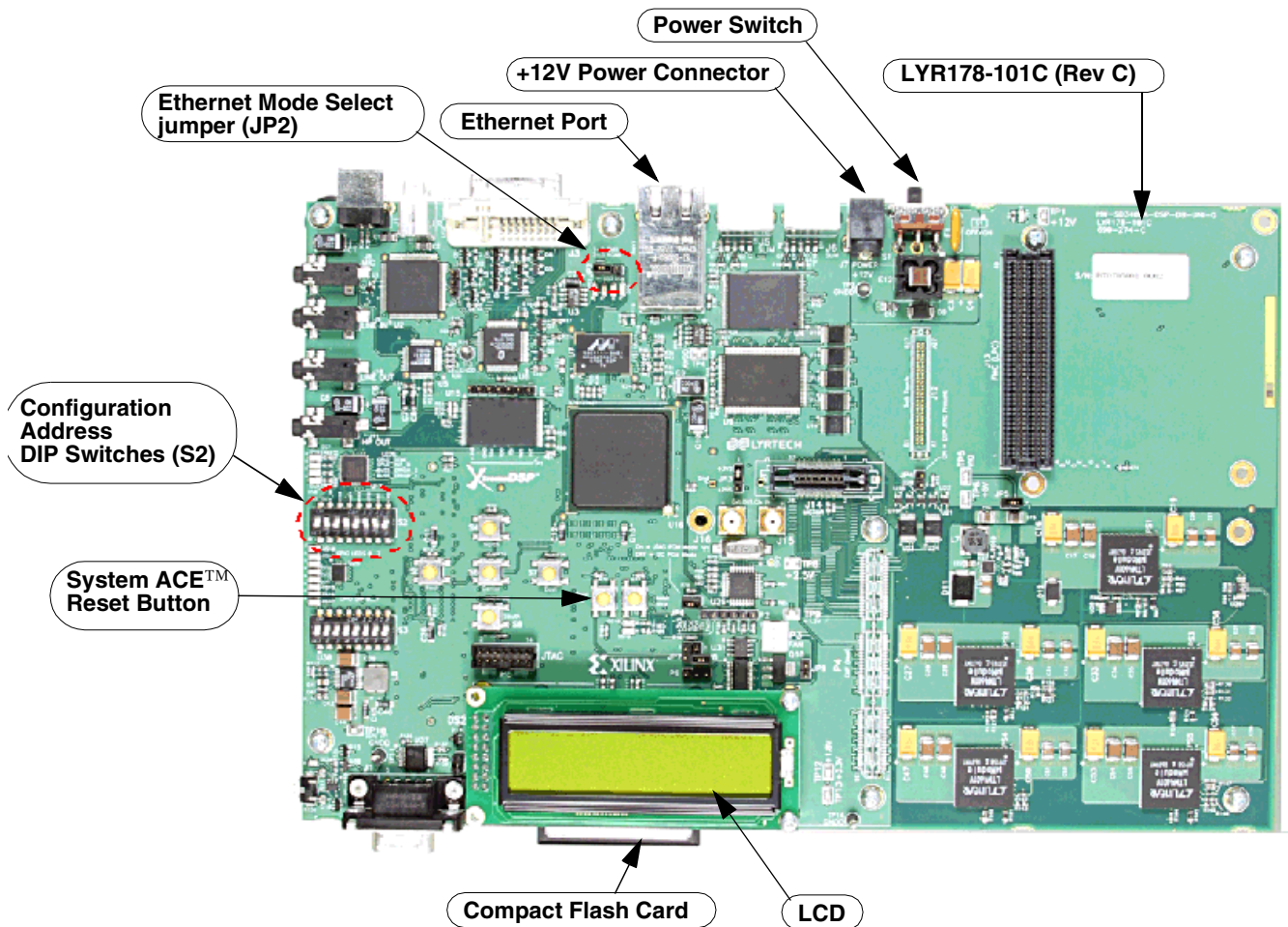

The figure below illustrates the Spartan-3A 3400A Board (Rev D) components of interest in this setup procedure:

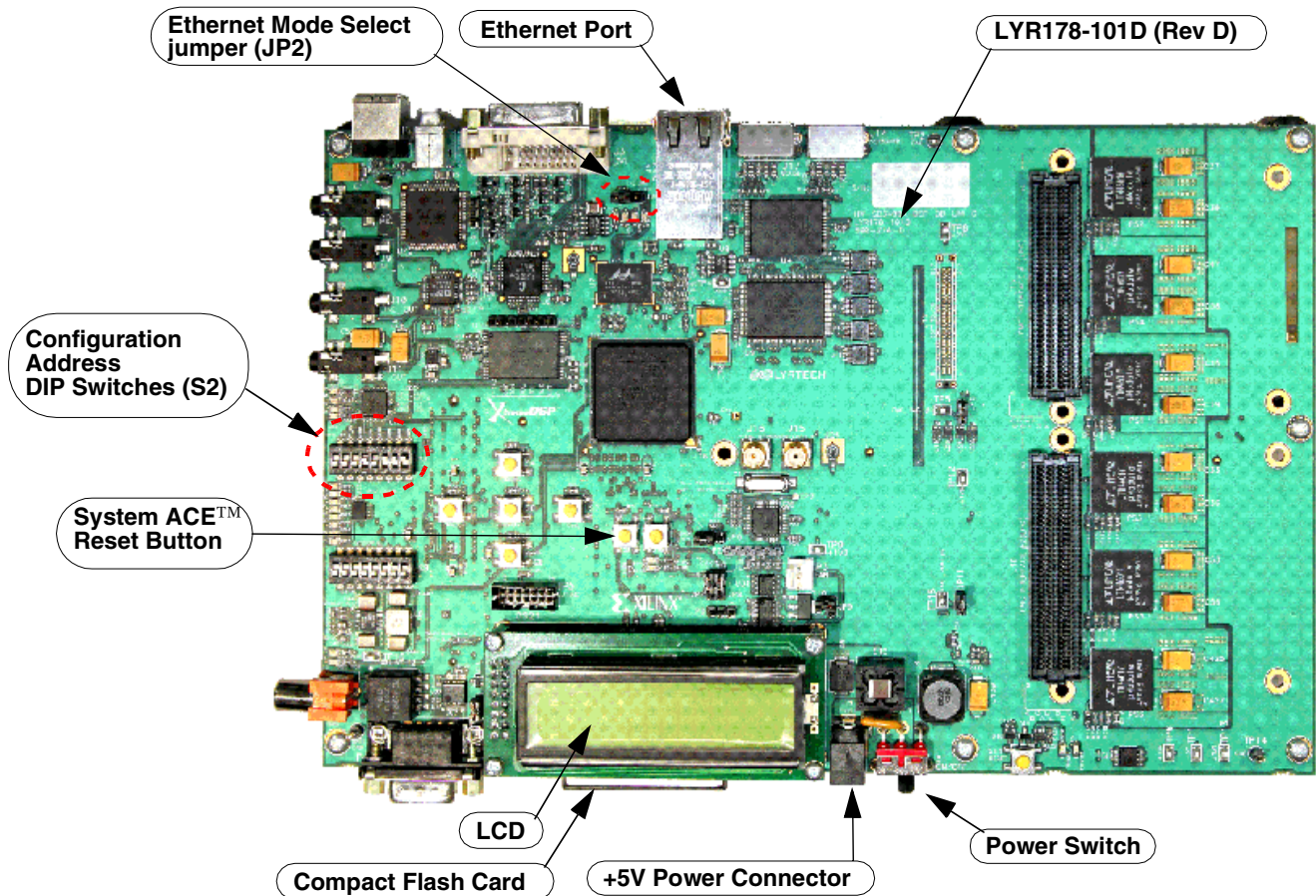

1. Position the Spartan-3A 3400A Development Board as shown above with the LCD display at the bottom.
2. Make sure the power switch is in the OFF position.
3. As shown below, **Eject** the CompactFlash card from the CompactFlash Reader.

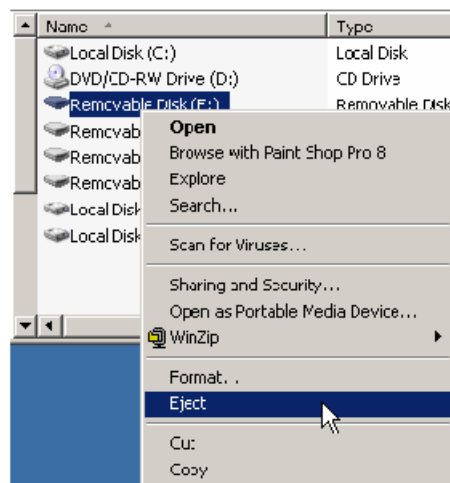

4. Remove the CompactFlash card from the CompactFlash Reader.
5. Locate the CompactFlash card slot (on the back side of the Spartan-3A 3400A Board) and carefully insert the CompactFlash card with its front label facing away from the board. The figure below shows the back side of a board with the CompactFlash card properly inserted.

**Note:** The CompactFlash card provided with your board might differ.

**Caution!** Be careful when inserting or removing the CompactFlash card from the slot. Do not force it.



6. If you are using a "Rev C" 3400A Development Board, plug the +12V power supply adapter cable into the power connector. Plug in the power supply into AC power.  
If you are using a "Rev D" 3400A Development Board, plug the +5V power supply adapter cable into the power connector. Plug in the power supply into AC power.  
**Caution!** Make sure you use an appropriate power supply with the correct voltage and power ratings.
7. Using the RJ45 Male/Male Ethernet Cable, connect the Ethernet connector on the Spartan-3A 3400A board directly to the Ethernet connector on the host PC.
8. Set the S2 Configuration Address DIP Switches as follows:  
**1:off, 2:on, 3:off, 4:on, 5:off, 6:on, 7:on, 8:off**
9. Set the Ethernet Mode Select jumper JP2 to pin 1 and pin 2 (the default GMII).
10. Verify the Configuration Settings
  - a. Turn the target board Power switch **ON**.
  - b. As shown below, check the information displayed on the 16-character 2-line LCD screen of the board. If no error occurred, the Ethernet MAC address (without colons) should appear on the first line of the display and the IPv4 address should appear on the second line.

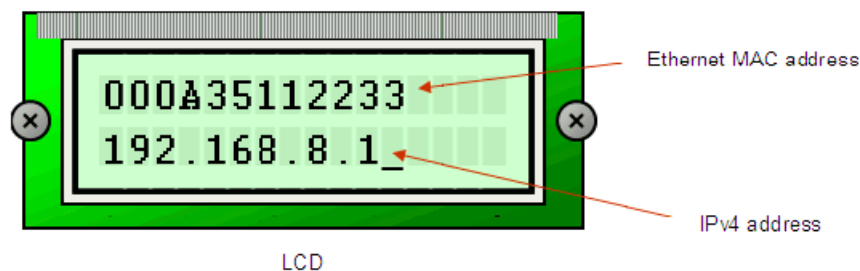

- c. If the LCD display does not show the information correctly, press the System ACE™ Reset button to reconfigure the FPGA.
11. Verify the Ethernet Interface and Connection Status
    - a. To ensure the board is reachable by the host, issue ICMP ping from the host to check the connectivity. For example, type "ping 192.168.8.1" on a console to test the connectivity to a board with IP address 192.168.8.1.

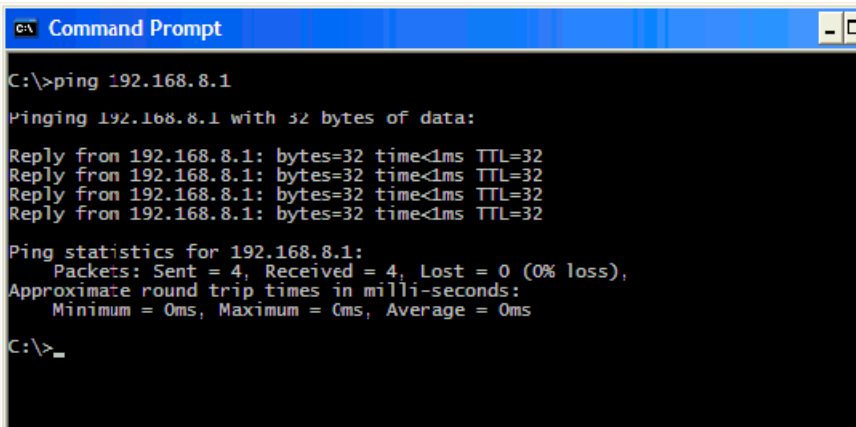

```
C:\>ping 192.168.8.1

Pinging 192.168.8.1 with 32 bytes of data:

Reply from 192.168.8.1: bytes=32 time<1ms TTL=32
Reply from 192.168.8.1: bytes=32 time<1ms TTL=32
Reply from 192.168.8.1: bytes=32 time<1ms TTL=32
Reply from 192.168.8.1: bytes=32 time<1ms TTL=32

Ping statistics for 192.168.8.1:
    Packets: Sent = 4, Received = 4, Lost = 0 (0% loss),
    Approximate round trip times in milli-seconds:
        Minimum = 0ms, Maximum = 0ms, Average = 0ms

C:\>_
```

- b. The target FPGA listens on the UDP port 9999. Please ensure the underlying network does not block the associated traffic when network-based Ethernet configuration is used. This does not affect point-to-point Ethernet configuration.

For in-depth reference information on the Spartan-3A 3400A Development Board, please refer to the following online manual:

[http://www.xilinx.com/support/documentation/boards\\_and\\_kits/ug498\\_s3a\\_3400\\_board.pdf](http://www.xilinx.com/support/documentation/boards_and_kits/ug498_s3a_3400_board.pdf)



## Installing an SP601/SP605 Board for Ethernet Hardware Co-Simulation

The following procedure describes how to install and setup the hardware and software required to run Ethernet Hardware Co-Simulation on an SP601/SP605 board.

### Assemble the Required Hardware

1. Xilinx Spartan®-6 SP605 Kit includes the following:
  - a. Spartan-6 LXT SP605 board
  - b. 12V Power Supply
  - c. Xilinx Platform USB cable
  - d. Xilinx Point-to-point Ethernet cable

### Install Related Software

Install the related software on the PC as described in the topic [Installing Software on the Host PC](#).

### Setup the SP601/SP605 Board

The figure below illustrates the SP605 components of interest in this JTAG setup procedure:

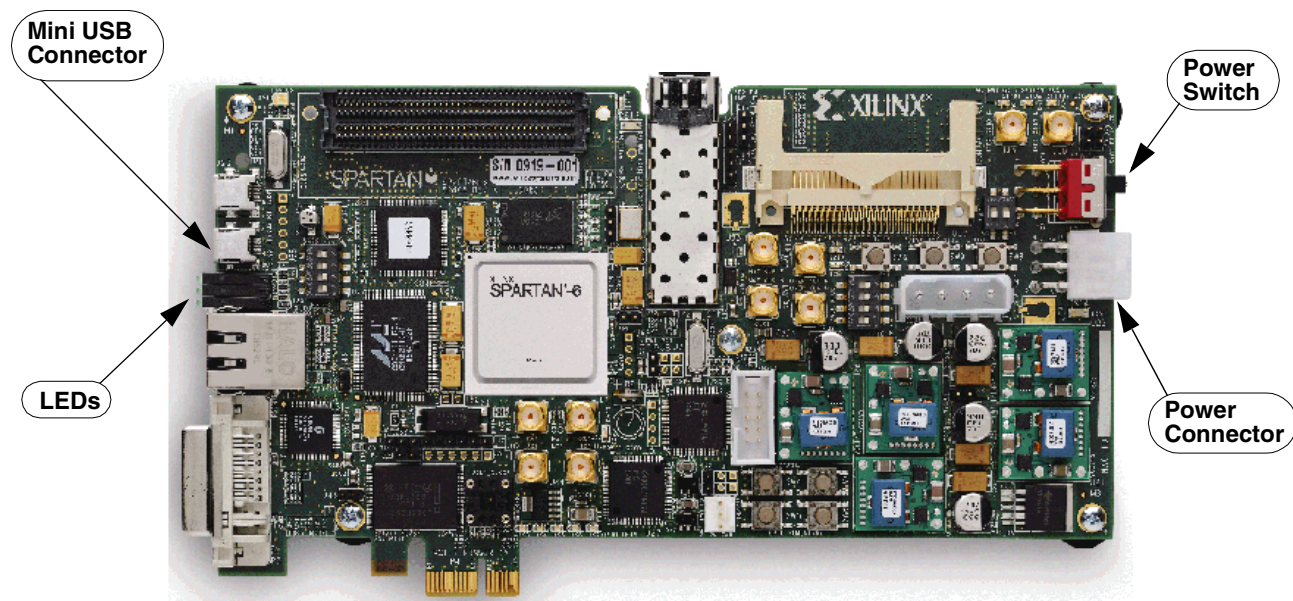

2. Make sure the power switch, located in the right edge of the board, is in the **OFF** position.
3. On the SP605 board, connect the small end of the Mini USB cable to the connector USB socket closest to the LEDs, as shown below. On the SP601 board, connect the small end of the USB cable to the socket labeled "USB JTAG".

Connecting Xilinx USB cable to the SP605 board

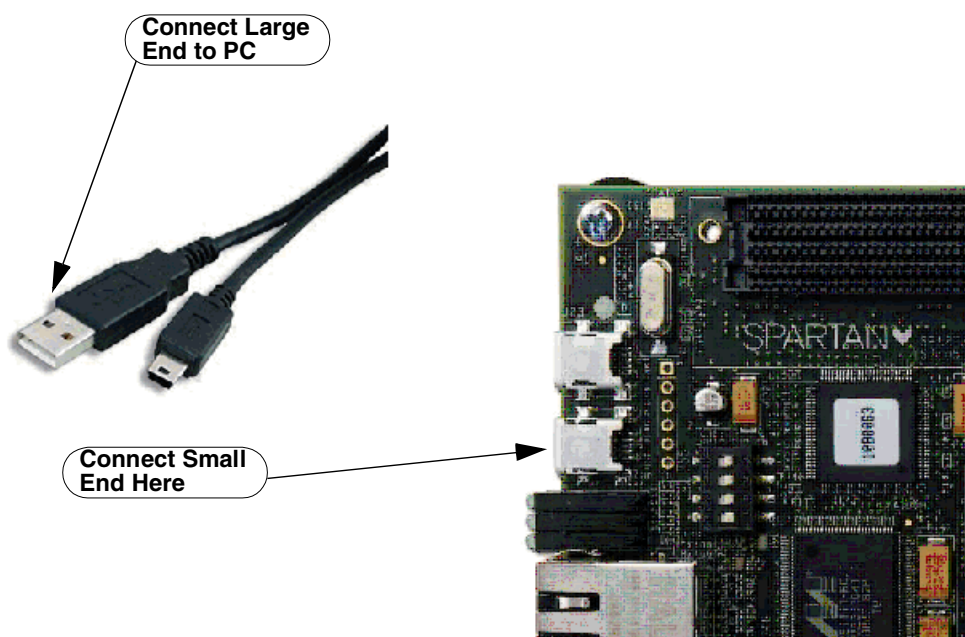

Connecting Ethernet cable and USB JTAG cable to the SP601 board

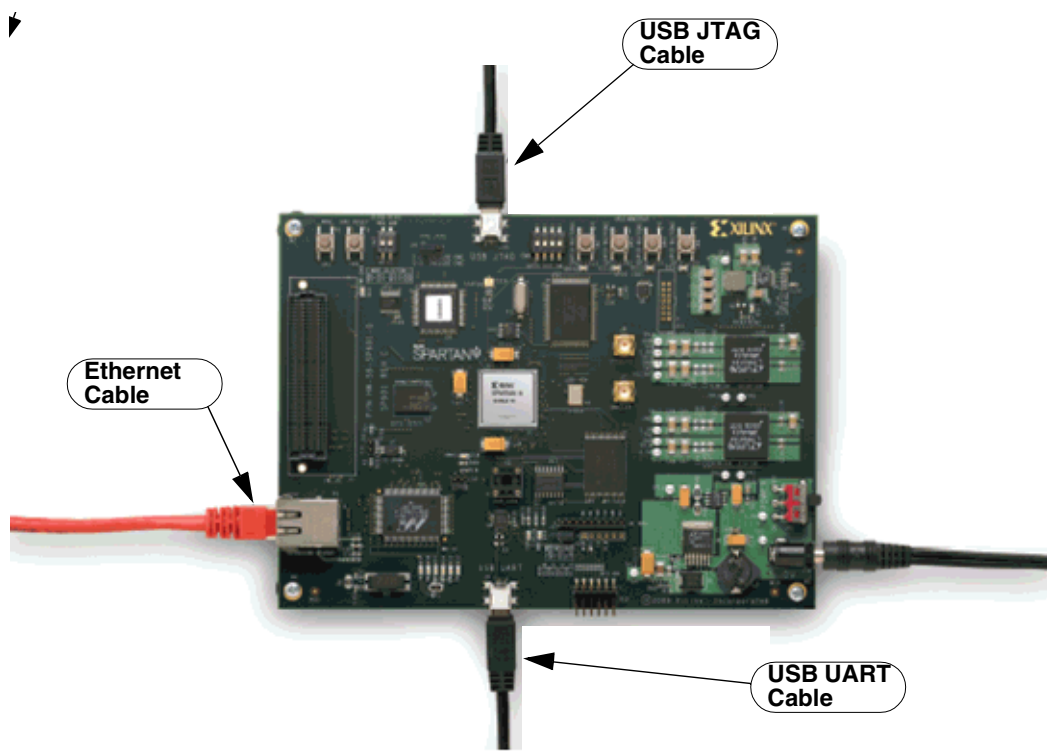

4. Connect the large end of the Mini USB cable to a USB socket on your PC.
5. Connect one end of the Ethernet cable to the Ethernet socket on the SP601/SP605 board and the other end to the Ethernet socket on the PC.

6. Connect the AC power cord to the power supply brick. Plug the power supply adapter cable into the SP601/SP605 board. Plug in the power supply to AC power.
7. Turn the SP601/SP605 board Power switch ON.

## Installing Your Board for JTAG Hardware Co-Simulation

### Installing an ML402 Board for JTAG Hardware Co-Simulation

The following procedure describes how to install and setup the hardware and software required to run JTAG Hardware Co-Simulation on an ML402 board.

#### Assemble the Required Hardware

1. Xilinx Virtex®-4 SX ML402 board which includes the following:
  - a. Virtex-4 ML402 board
  - b. 5V Power Supply bundled with the ML402 kit
  - c. CompactFlash Card
2. You also need the following items on hand:
  - a. Xilinx Parallel Cable IV with associated Power Jack splitter cable or Xilinx Platform USB Cable and a 14-pin ribbon cable.
  - b. CompactFlash Reader for the PC.

#### Install Xilinx ISE Design Suite Software on the Host PC

Install Xilinx ISE® Design Suite software in the Host PC as described in the document:

[IXilinx Design Tools: Installation and Licensing Guide](#)

#### Setup the ML402 Board

The figure below illustrates the ML402 components of interest in this JTAG setup procedure:

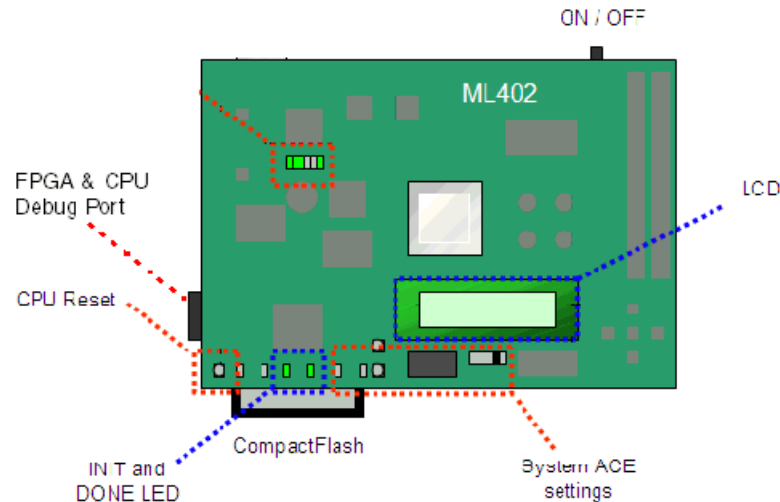

1. Position the ML402 board so the Virtex®-4 and Xilinx logos are oriented near the top edge of the board.
2. Make sure the power switch, located in the upper-right corner of the board, is in the **OFF** position.
3. If you are using a Xilinx Parallel Cable IV, follow steps 3a through 3d.
  - a. Connect the DB25 Plug Connector on the Xilinx Parallel Cable IV to the IEEE-1284 compliant PC Parallel (Printer) Port Connector.
  - b. Using the narrow (14 pin) 6" High Performance Ribbon cable, connect the pod end of the Xilinx Parallel Cable IV to the **FPGA & CPU Debug Port** (shown above) on the ML402 board.
  - c. Connect the attached Power Jack cable to the Keyboard/Mouse connector on the PC.
  - d. If necessary, connect the male end of the Keyboard/Mouse cable to the associated female connector on the Xilinx Power Jack cable (splitter cable).
4. If you are using a Xilinx Platform Cable USB, follow step 4a and 4b.
  - a. Connect the Xilinx Platform Cable USB to a USB port on the PC.
  - b. Using the narrow (14 pin) 6" High Performance Ribbon cable, connect the pod end of the Xilinx Platform Cable USB to the **FPGA & CPU Debug Port** (shown above) on the ML402 board.
5. Connect the AC power cord to the power supply brick. Plug the power supply adapter cable into the ML402 board. Plug in the power supply to AC power.

**Caution!** Make sure you use an appropriate power supply with correct voltage and power ratings.
6. Turn the ML402 board Power switch **ON**.



## Installing an ML605 Board for JTAG Hardware Co-Simulation

The following procedure describes how to install and setup the hardware and software required to run JTAG Hardware Co-Simulation on an ML605 board.

### Assemble the Required Hardware

1. Xilinx Virtex®-6 SX ML605 board which includes the following:
  - a. Virtex-6 ML605 board
  - b. 12V Power Supply bundled with the ML605 kit
  - c. Mini USB cable

### Install Xilinx ISE Design Suite Software on the Host PC

Install Xilinx ISE® Design Suite software in the Host PC as described in the document:

[\*Xilinx Design Tools: Installation and Licensing Guide\*](#)

### Setup the ML605 Board

The figure below illustrates the ML605 components of interest in this JTAG setup procedure:

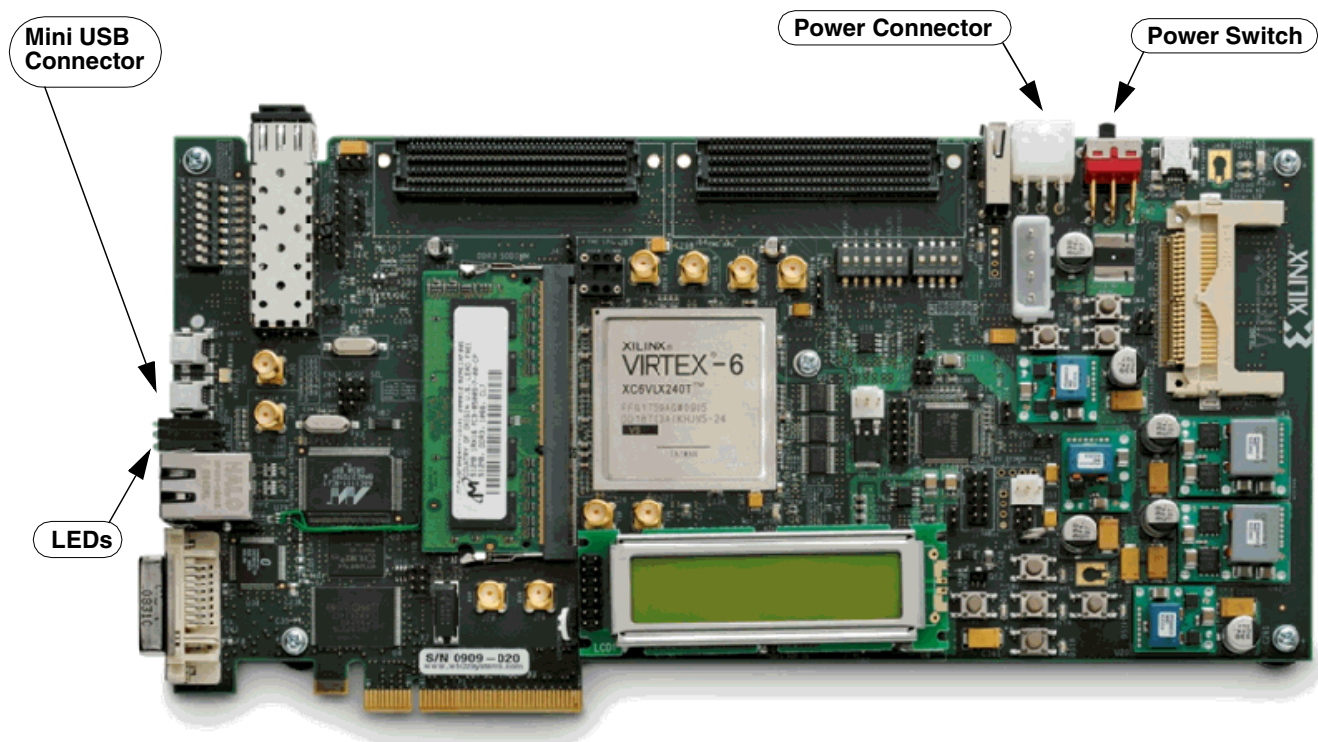

1. Position the ML605 board as shown above.
2. Make sure the power switch, located in the upper-right corner of the board, is in the **OFF** position.

- As shown below, connect the small end of the Mini USB cable to the connector USB socket closest to the LEDs.

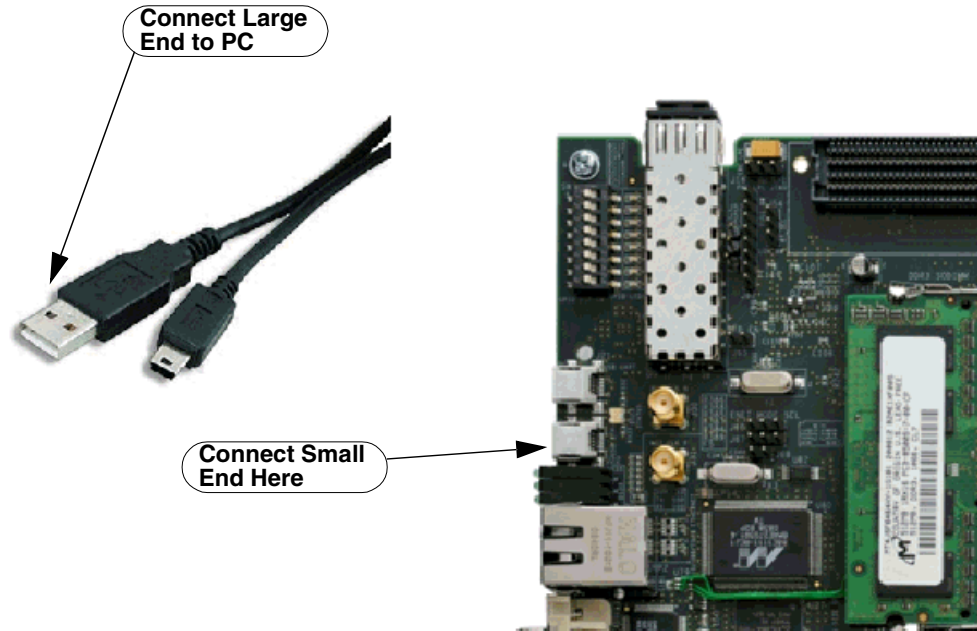

- Connect the large end of the Mini USB cable to a USB socket on your PC. As shown below, the LED next to the Mini USB connector turns green when the cable is connected properly.

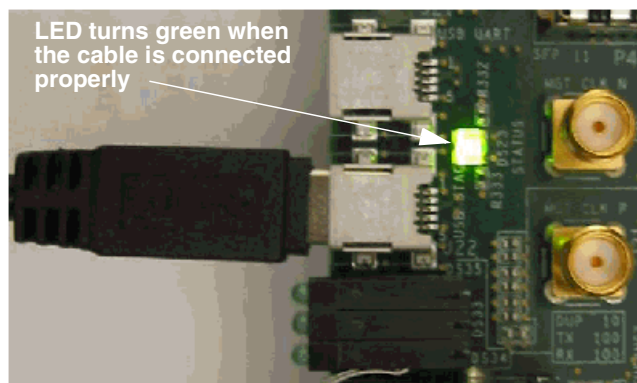

- Connect the AC power cord to the power supply brick. Plug the power supply adapter cable into the ML605 board. Plug in the power supply to AC power.
 

**Caution!** Make sure you use an appropriate power supply with correct voltage and power ratings.
- Turn the ML605 board Power switch ON.

## Installing an SP601/SP605 Board for JTAG Hardware Co-Simulation

The following procedure describes how to install and setup the hardware and software required to run JTAG Hardware Co-Simulation on an SP601/SP605 board.

### Assemble the Required Hardware

1. Xilinx Spartan®-6 SP601/SP605 Kit includes the following:
  - a. Spartan-6 LXT SP601/SP605 board
  - b. 12V Power Supply
  - c. Mini USB cable

### Install Xilinx ISE Design Suite Software on the Host PC

Install Xilinx ISE® Design Suite software in the Host PC as described in the document:

Install Xilinx ISE® Design Suite software in the Host PC as described in the document:

[IXilinx Design Tools: Installation and Licensing Guide](#)

### Setup the SP601/SP605 Board

The figure below illustrates the SP605 components of interest in this JTAG setup procedure:

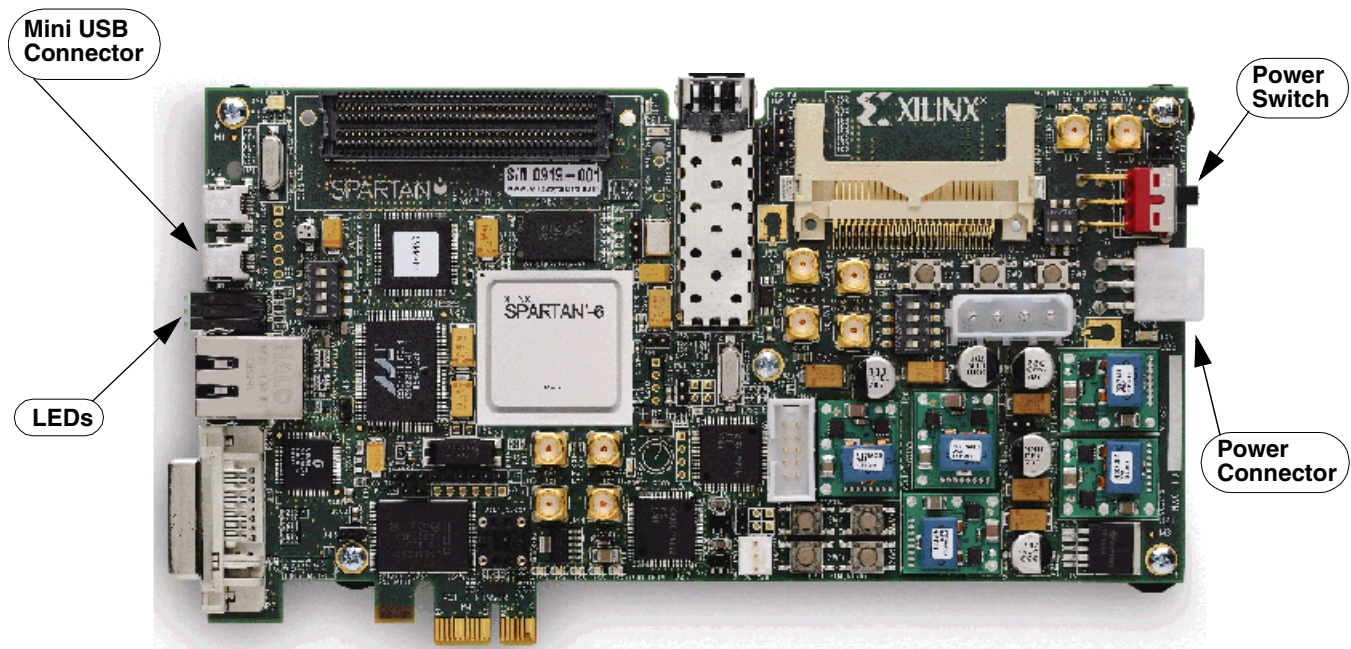

1. Position the SP605 board as shown above.
2. Make sure the power switch, located in the right edge of the board, is in the **OFF** position.
3. As shown below, connect the small end of the Mini USB cable to the connector USB socket closest to the LEDs.



Connecting Xilinx USB cable to the SP605 board

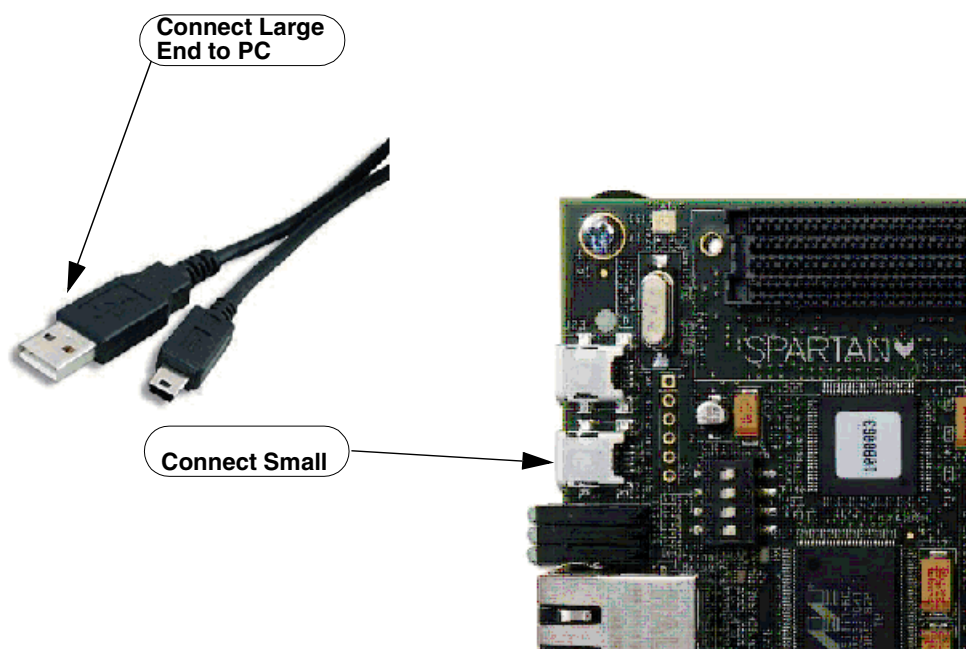

Connecting Xilinx USB cable and AC power cable to the SP601 board

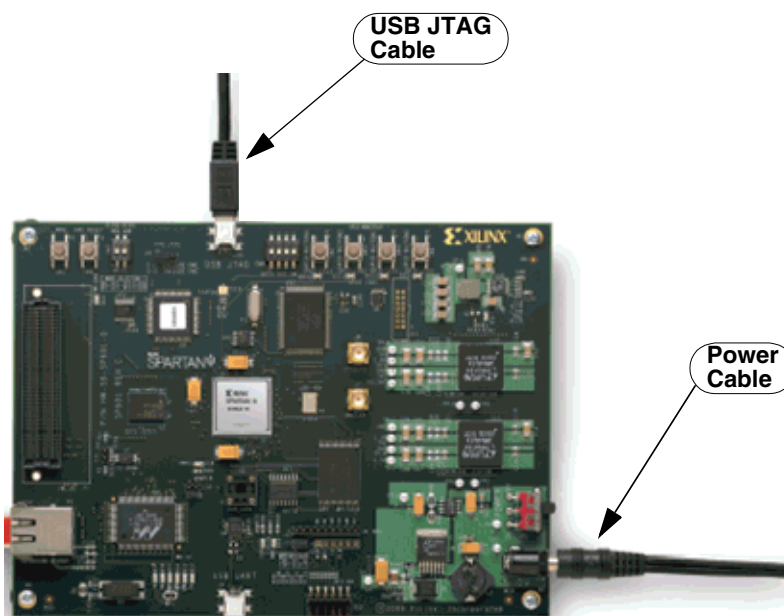

4. Connect the large end of the Mini USB cable to a USB socket on your PC.
5. Connect the AC power cord to the power supply brick. Plug the power supply adapter cable into the SP601/SP605 board. Plug in the power supply to AC power.
6. Turn the SP601/SP605 board Power switch ON.

## Installing a KC705 Board for JTAG Hardware Co-Simulation

The following procedure describes how to install and setup the hardware and software required to run JTAG Hardware Co-Simulation on an KC705 board.

### Assemble the Required Hardware

1. Xilinx Kintex®-7 KC705 board which includes the following:
  - a. Kintex®-7 KC705 board
  - b. 12V Power Supply bundled with the KC705 kit
  - c. Micro USB-JTAG cable

### Install Xilinx ISE Design Suite Software on the Host PC

Install Xilinx ISE® Design Suite software in the Host PC as described in the document:

[\*Xilinx Design Tools: Installation and Licensing Guide\*](#)

### Install the Digilent ChipScopePlugin

If you have not already installed the Digilent ChipScope Plugin during the IDS installation, do the following:

1. Navigate to the **digilent** subfolder in the Xilinx installation tree,;  
`$XILINX\bin\<OS>\digilent`  
Windows 32, for example, is in the following folder:  
`C:\Xilinx\14.1\ISE_DS\ISE\bin\nt\digilent`
2. Double click on the **install\_digilent.exe** executable and follow the wizard instructions to install the plugin.

## Setup the KC705 Board

The figure below illustrates the KC705 components of interest in this JTAG setup procedure:

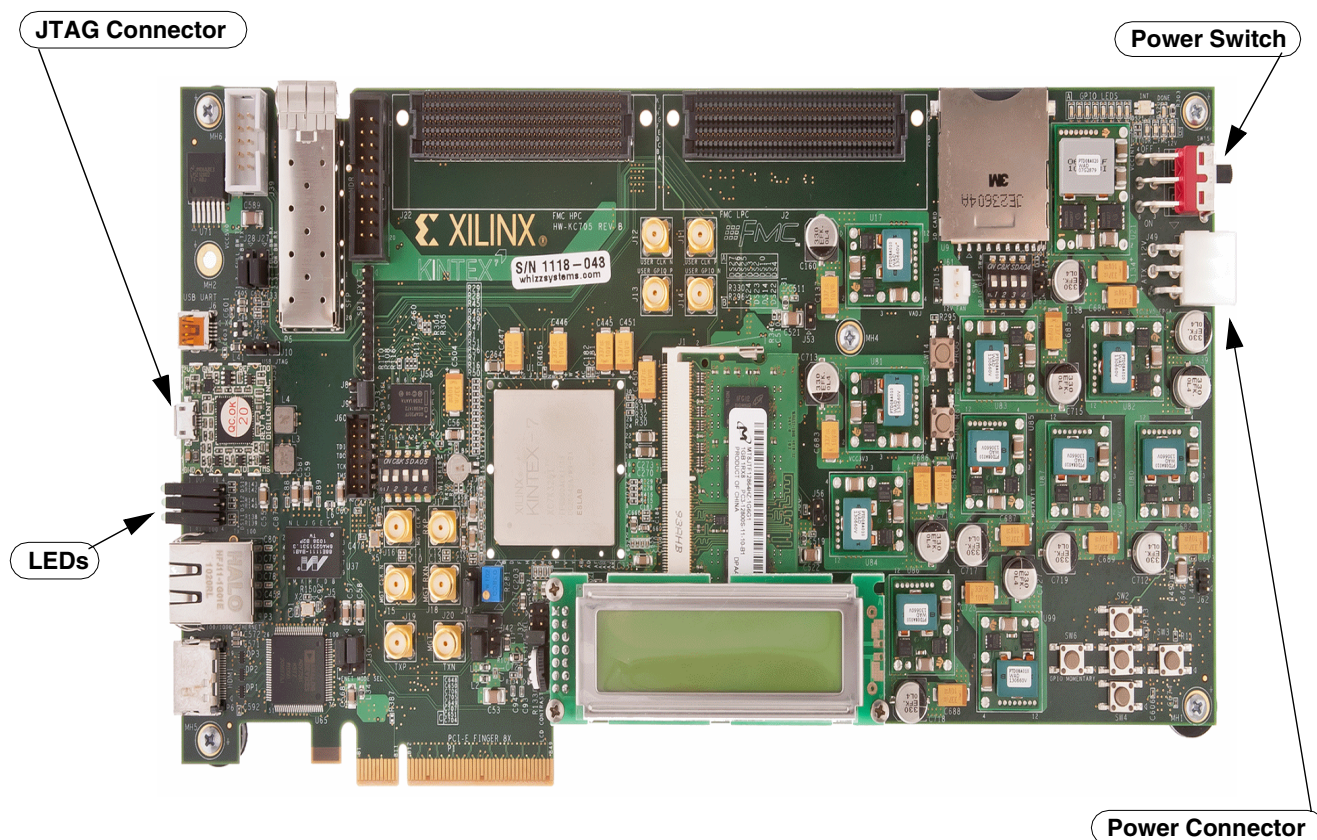

1. Position the KC705 board as shown above.
2. Make sure the power switch, located in the upper-right corner of the board, is in the **OFF** position.
3. Connect the small end of the Micro USB-JTAG cable to the JTAG socket.
4. Connect the large end of the Micro USB-JTAG cable to a USB socket on your PC.
5. Connect the AC power cord to the power supply brick. Plug the power supply adapter cable into the KC705 board. Plug in the power supply to AC power.
6. Turn the KC705 board Power switch **ON**.

# Supporting New Boards through JTAG Hardware Co-Simulation

System Generator provides a generic interface that uses JTAG and a Xilinx programming cable (e.g., Parallel Cable IV or Platform Cable USB) to communicate with FPGA hardware. This takes advantage of the ability of JTAG to extend System Generator's hardware in the simulation loop capability to numerous other FPGA boards.

## Hardware Requirements

An FPGA board can support the JTAG hardware co-simulation interface, provided it includes the following hardware components:

- A Xilinx FPGA part that is available in System Generator as a supported device (i.e., a device that can be chosen in the **Part** field of the System Generator token dialog box);
- An on-board oscillator that supplies the FPGA with a free-running clock source;
- A JTAG header that provides access to the FPGA.

## Supporting New Boards

Although the JTAG hardware co-simulation interface is generic, an FPGA board must provide its own board support package before it can be supported in System Generator. A board support package is comprised of four files that provide information about the board, or board. A number of FPGA boards already have board support packages available. You may have an FPGA board that does not have a hardware co-simulation board support package. In this case, you can create your own, assuming your board meets the specified [Hardware Requirements](#). Creating a new board support package for a board is a straightforward process. System Generator provides a utility, called the System Generator Board Description Builder (SBDBuilder), that allows you to create new board support packages in a graphical environment. It is also possible to define board support packages manually by editing a series of template files that are included in the System Generator software tree.

SBDBuilder can be launched by using the command `x1SBDBuilder` in the MATLAB console. Alternatively, SBDBuilder can also be launched from the System Generator Token by double-clicking on the System Generator token; under **Compilation** select **Hardware Co-Simulation > New Compilation Target ...**

## SBDBuilder Dialog Box

After invoking SBDBuilder, the main dialog box will appear as shown below:

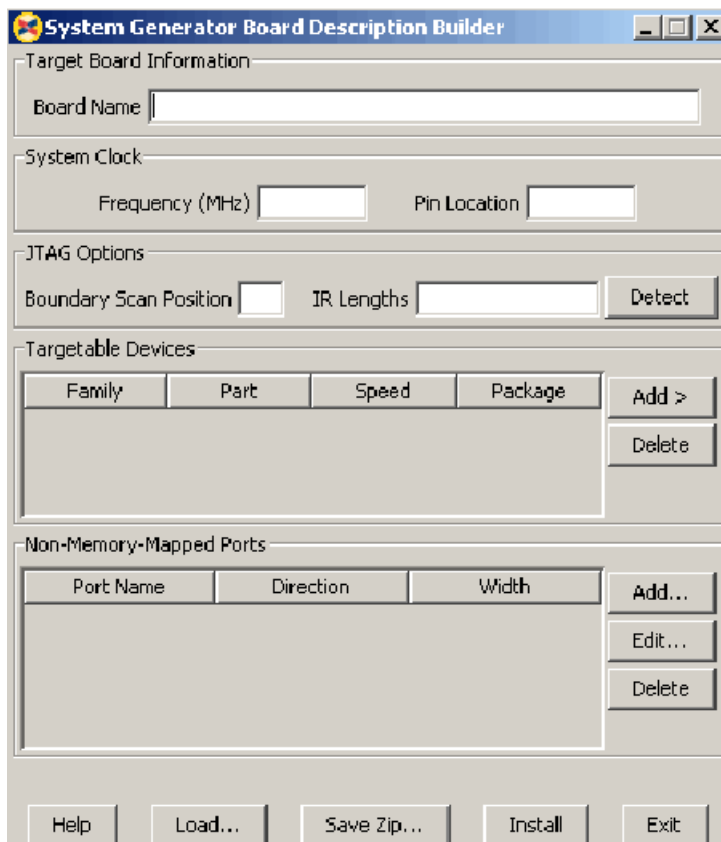

Once the main dialog box is open, you may create a board support package by filling in the required fields described below:

**Board Name:** Tells a descriptive name of the board. This is the name that will be listed in System Generator when selecting your JTAG hardware co-simulation board for compilation.

**System Clock:** JTAG hardware co-simulation requires an on-board clock to drive the System Generator design. The fields described below specify information about the board's system clock:



- Frequency (MHz):** Specifies the frequency of the on-board system clock in MHz.
  - Note:** You should use a clock frequency between 10 MHz and 100 MHz. Depending on the target FPGA device and your design, the design compiled for hardware co-simulation may not meet timing constraints at a higher clock frequency after the hardware co-simulation logic is added.
- Pin Location:** Specifies the FPGA input pin to which the system clock is connected.

**JTAG Options:** System Generator needs to know several things about the FPGA board's JTAG chain to be able to program the FPGA for hardware co-simulation. The topic [Obtaining Platform Information](#) describes how and where to find the information required for these fields. If you are unsure of the specifications of your board, please refer to the manufacturer's documentation. The fields specific to JTAG Options are described below:

- Boundary Scan Position:** Specifies the position of the target FPGA on the JTAG chain. This value should be indexed from 1. (e.g. the first device in the chain has an index of 1, the second device has an index of 2, etc.)
- IR Lengths:** Specifies the lengths of the instruction registers for all of the devices on the JTAG chain. This list may be delimited by spaces, commas, or semicolons.
- Detect:** This action attempts to identify the IR Lengths automatically by querying the FPGA board. The board must be powered and connected to a Parallel Cable IV for this to function properly. Any unknown devices on the JTAG chain will be represented with a "?" in the list, and must be specified manually.

**Targetable Devices:** This table displays a list of available FPGAs on the board for programming. This is not a description of all of the devices on the JTAG chain, but rather a description of the possible devices that may exist at the aforementioned boundary scan position. For most boards, only one device needs to be specified, but some boards may have alternate, e.g., a choice between an xc1v1000 or an xc1v2000 in the same socket. Use the **Add** and **Delete** buttons described below to build the device list:

- Add:** Brings up a menu to select a new device for the board. As shown in the figure below, devices are organized by family, then part name, then speed, and finally the package type.
- Delete:** Remove the selected device from the list.

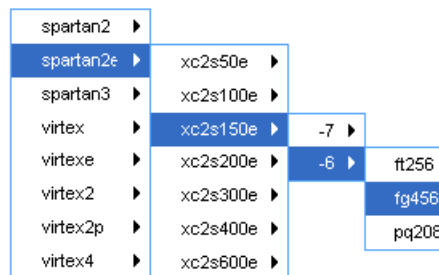

**Non-Memory-Mapped Ports:** You can add support for your own board-specific ports when creating a board support package. Board-specific ports are useful when you have on-board components (e.g., external memories, DACs, or ADCs) that you would like the FPGA to interface to during hardware co-simulation. Board specific ports are also referred to as non-memory-mapped because when the design is compiled for hardware co-simulation, these ports will be mapped to their physical locations, rather than creating Simulink ports. See [Specifying Non-Memory Mapped Ports](#) for more information. The **Add**, **Edit**, and **Delete** buttons provide the controls needed for configuring non-memory mapped ports.

- **Add:** Brings up the dialog to enter information about the new port.
- **Edit:** Make changes to the selected port.
- **Delete:** Remove the selected port from the list.

**Help:** Displays this documentation.

**Load:** Fill in the form with values stored in an SBDBuilder Saved Description XML file. This file is automatically saved with every plugin that you create, so it is useful for reloading old plugin files for easy modification.

**Save Zip:** Prompts you for a filename and a target pathname. This will create a zip file with all of the plugin files for System Generator. The zip will be in a suitable format for passing to the System Generator [xlInstallPlugin](#) function.

**Exit:** Quit the application.

### Specifying Non-Memory Mapped Ports

You may use SBDBuilder to specify the non-memory mapped ports for your FPGA board. When you choose to Add or Edit a non-memory mapped port from the main dialog, the port editor dialog will come up as shown below.

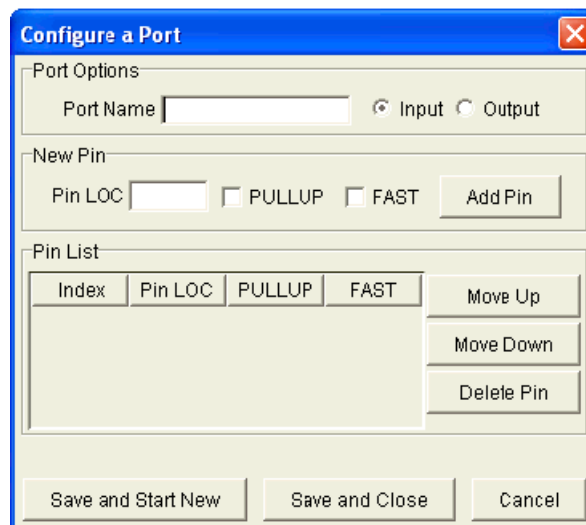

The port editor dialog presents the following controls for port configuration:

**Port Options:** Specifies the options that will affect the entire port.

- **Port Name:** This is the name that will describe the port in System Generator. It should be a MATLAB-compatible name (begins with a letter, followed by only letters, numbers, and underscores).
- **Input/Output:** Specifies the direction of the port.

**New Pin:** This is the entry point to add pins to a port. Ports may consist of a single pin for a Boolean value, or multiple pins for a vector or bus.

- **Pin LOC:** Defines the absolute placement of the pin within the FPGA by specifying a location constraint. It is necessary to define this for every pin to make sure that the FPGA programming corresponds to the actual hardware connections.
- **PULLUP:** A constraint that can be applied to each pin. It guarantees a logic High level to allow 3-stated nets to avoid floating when not being driven.

- **FAST:** A constraint that can be applied to each pin. It increases the speed of an IOB output. FAST produces a faster output but may increase noise and power consumption.
- **Add Pin:** Add a pin to the port. Note that the pin is not part of the port until this button is selected.

**Note:** Pressing 'enter' while the cursor is in the Pin LOC field is equivalent to pressing this button.

**Pin List:**

- **Index:** (Cannot edit directly) Since a port can be more than one bit, it is represented as a vector of pins. The index indicates which bit position a particular pin represents in the port. Zero is the least-significant bit.
- **Move Up/Down:** Move the selected pin up or down in the pin list. This is useful to correct the vector bit-ordering of the port.
- **Delete Pin:** Removes the selected pin from the list.

**Save and Start New:** Save the port to the board support package. The form will then be cleared so that you may enter a new port.

**Save and Close:** Save the port to the board support package and return to the main screen.

**Cancel:** Discard changes to the current port and return to the main screen.

When you are finished entering a port, it will look similar to the dialog box shown below:

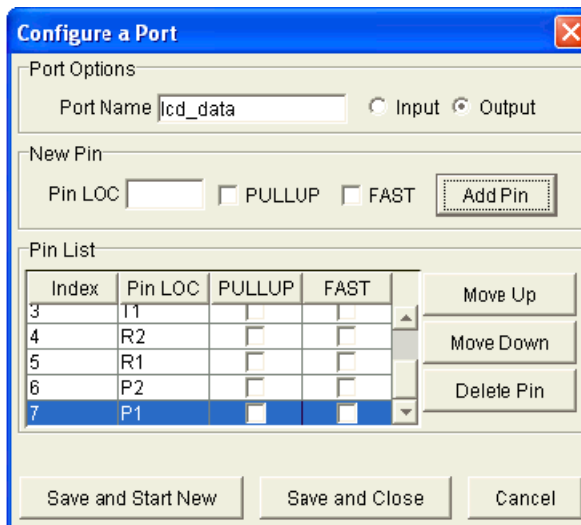

## Saving Plugin Files

Once you have filled out the dialog box with information about your board, it should resemble the dialog box shown below:

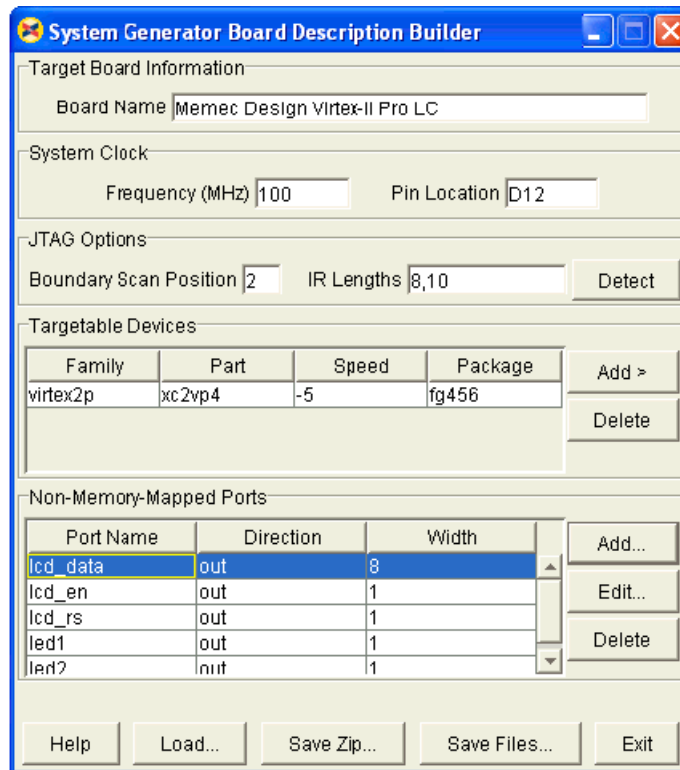

At this point, you can save the board support package into a System Generator plugin zip file or as the raw board support package files described in the topic [Board Support Package Files](#), plus the additional SBDBuilder files described below:

- **yourboard.xml**: This is the SBDBuilder Saved Description, which allows SBDBuilder to reload plugins you have previously created. The name you select for this file ('yourboard') will propagate into the names of the other files as well.
- **yourboard\_libgen.m**: Automates the process of creating the gateways for the non-memory-mapped ports on this device. Running this script results in the creation a library like that shown below:

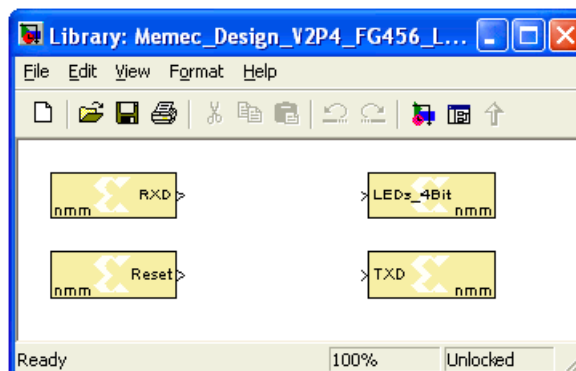

## Board Support Package Files

An FPGA board that supports JTAG hardware co-simulation is defined in System Generator by its board support package. This package tells System Generator useful information about the board, such as the appropriate part settings and additional information related to the JTAG and Boundary Scan interface provided by the board. A board support package is comprised of the files listed below:

**Note:** In this document, three of the filenames are prefixed by the name 'yourboard'. This prefix should be replaced with a moniker suitable for 'your board' (e.g., xtremedspkit, mblazedemo).

1. **xltarget.m** – Tells System Generator that your FPGA board is a compilation target. There is a unique xltarget.m file for each compilation target. This function tells the tool the name of the compilation target (this name is shown in the compilation target field of the System Generator token dialog box) and also the name of the function where it can look for information about the particular board.
2. **yourboard\_target.m** – Configures the System Generator token dialog box with information about the FPGA board, including device and part information, clock frequency, and the location of the clock pin.
3. **yourboard\_postgeneration.m** – Tells System Generator the scripts to run after HDL netlist generation in order to produce an FPGA configuration file that is suitable for your board. It also specifies non-System Generator token dialog box related information, including the position of the device in the board's Boundary Scan chain and the instruction register lengths of each device. This function is referred to as a post-generation function.
4. **yourboard.ucf** – User Constraints File (UCF) for the FPGA board. Specifies clock pin location and frequency, and optionally constrains any board-specific ports.

Included in the System Generator software tree are templates for the files listed above. If you would like to manually support a new board, you may customize each of the four template files with information that is specific to your board. You must also rename the files by substituting a suitable name in place of the 'yourboard' prefix.

Each template is fully annotated with step-by-step instructions that indicate which fields should be modified, and the types of values that should be given to these fields. The fields that must be modified are underlined using "~~~" notation. The template files can be found in the `sysgen/hwcosim/jtag/templates` directory of your System Generator install tree.

## Obtaining Platform Information

SBDBuilder (or alternatively, the board support package template files) require certain information about your FPGA board. The table below lists the information you need.

Information	Description
Clock pin location	Pin location constraint for the FPGA system clock source.
Clock period	Period constraint for the FPGA system clock source.
Device position in the Boundary Scan Chain	Tells the position of the target FPGA in the board's Boundary Scan Chain. Indexing begins at 1, with device 1 being the first device in the chain.
Instruction register lengths	Instruction register length of every device in the Boundary Scan Chain.

You may obtain the clock pin location and period from any number of possible sources, including the vendor documentation, existing constraints files, or vendor online documentation/support.

If you do not know which devices are in your board's boundary scan chain, you may use iMPACT to assist you in finding this information. iMPACT is a tool that is included with the Xilinx ISE® software that allows you to perform device configuration and file generation functions. When the tool is invoked, it automatically detects the contents of your board's boundary scan chain, and displays these contents graphically, as shown below.

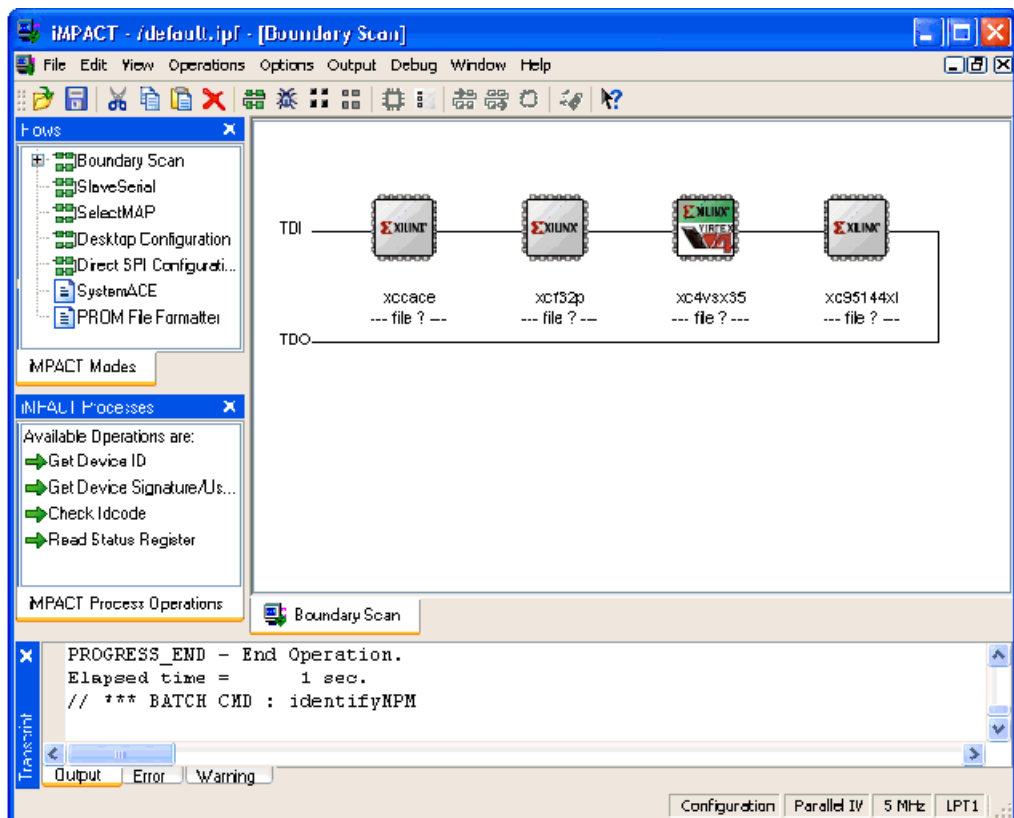

Once you have determined which devices are in the Boundary Scan Chain, you must determine the instruction register lengths for each device. The table below specifies the instruction register lengths for various Xilinx families. You may use the auto detection capability of SBDBuilder to determine the instruction register lengths. If this utility does not work, you may use the following table to find the instruction register lengths for a particular part family.

<b>Family</b>	<b>IR Length</b>
System_ACE™-CF	8
Spartan®-3, 3E, 3A, 3AN, 3A DSP	6
Spartan-6 LX, LXT	6
Virtex®-4 LX, SX	10
Virtex®-4 FX 12, 20	10
Virtex®-4 FX 40, 60, 100, 140	14
Virtex®-5 LX, LXT, SXT	10
Virtex®-5 FX 30T, 70T	10
Virtex®-5 FX 100T, 130T, 200T	14
Virtex®-6 LX, LXT	10
Platform Flash XCFxxS	8
Platform Flash XCFxxP	16

## Manual Specification of Board-Specific Ports

You can manually specify your own board-specific ports when creating a board support package. To define board-specific ports for your FPGA board, you must do the following:

- Add all board-specific ports to the `yourboard.ucf` template file. Each constraint should be accompanied by a special comment, `<port> contingent`, where `<port>` is the name of the board specific port. When System Generator compiles a model for hardware, it creates a custom UCF file. Constraints associated with signals that aren't used in the model are removed from the custom UCF file.

Example constraints for ports `adc1_d(0)` and `adc1_d(1)`:

```
net adc1_d(0) loc = af20; # adc1_d contingent
net adc1_d(1) loc = ad18; # adc1_d contingent
```

- Declare all board-specific ports in the `yourboard_postgeneration.m` function.

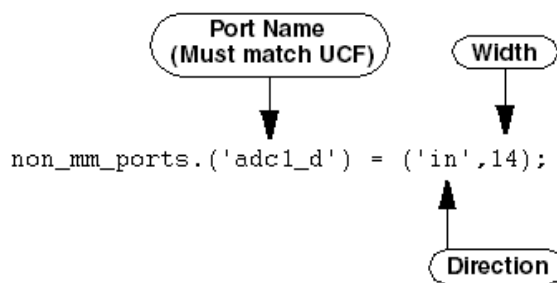

**Note:** Bi-directional ports are currently not supported.

Include this line in `yourboard_postgeneration.m` function:

```
params('non_memory_mapped_ports') = non_mm_ports;
```

- Customize a gateway with the board-specific port information:
  - ◆ Create a library and add a gateway
  - ◆ Name the Gateway with the name of your board specific port (this name must match the port name used in the post-generation function and UCF file)

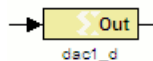

- ◆ Select the Gateway by clicking on it
- ◆ In the MATLAB command window, type the following
 

```
> xlSetNonMemMap(gcb, 'Xilinx', 'jtaghwcosim')
```
- ◆ Save the library

You are now ready to use your board-specific gateway in System Generator. When you include the gateway in your model, you must make sure the signals that drive (or are driven by) the gateway have widths that match the widths of the ports in hardware. You can force the width of a signal driving a gateway out by preceding it with a convert block.



**Note:** A subsystem (as shown below) is a convenient place to store the gateway out and convert block pairs.

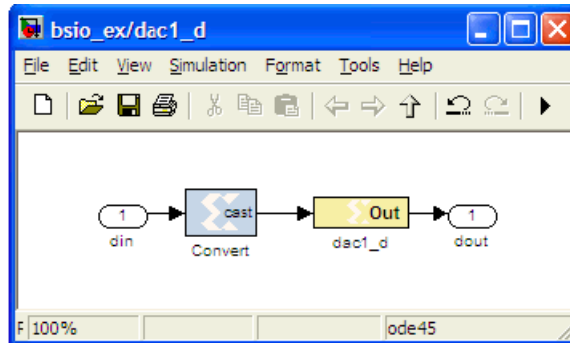

## Providing Your Own Top Level

When a model is compiled for JTAG hardware co-simulation, System Generator produces a generic top-level HDL entity for the design. This entity instantiates the logic required by the model and the interfacing logic required for JTAG hardware co-simulation.

Sometimes your board may have a special requirement that precludes you from using this generic top level. For example, your board may have components that rely on clocks that are generated by a DCM that resides in the board's FPGA. In these situations, System Generator allows you to use your own top-level netlist when it compiles the model into hardware.

**Note:** If you choose to use your own top-level component, you must provide a previously synthesized version (.ngc, .edf, .edn) to System Generator.

**Note:** Your top-level component must instantiate the generic JTAG hardware co-simulation top-level component. The component instantiation must include the required clocking signals, plus any board-specific I/O ports your board may support. An example component instantiation is provided below:

```
component jtagcosim_top port (
  -- required clocking ports
  sys_clk : in std_logic;
  cosim_clk : out std_logic;
  sys_clk_buf : out std_logic;
  -- board specific ports
  adc1_d : in std_logic_vector(13 downto 0);
  dac1_d : out std_logic_vector(13 downto 0);
  dac1_div0 : out std_logic;
  dac1_div1 : out std_logic;
  dac1_mod0 : out std_logic;
  dac1_mod1 : out std_logic;
  dac1_reset : out std_logic
);
end component;
```

You may specify your own top-level netlist in `yourboard_postgeneration.m` as follows:

```
params.vendor_toplevel = 'yourboard_toplevel';
```

Here `yourboard_toplevel` is the name of the pre-compiled, top-level netlist component you would like System Generator to use for the top level. You must also tell System Generator the netlist file names that are associated with the top-level component. These files are specified as shown below in `yourboard_postgeneration.m`.

```
params.vendor_netlists = {'yourboard_toplevel.ngc', 'foo.edf'};
```

## Installing Board-Support Packages

SBDBuilder can generate a plugin zip file for your board support package that may be installed automatically using the [xlInstallPlugin](#) utility provided with System Generator. You may manually install the board support package files if an appropriate plugin zip file is not provided. This topic describes how to install the files manually in your System Generator software tree.

### Plugins Directory

The System Generator software provides a special directory in which the board support package files for new compilation targets can be added. This directory, `plugins/compilation`, provides a repository for System Generator compilation target plugins, and has unique properties that are discussed later in this topic. Your System Generator software tree should resemble the tree hierarchy shown below.

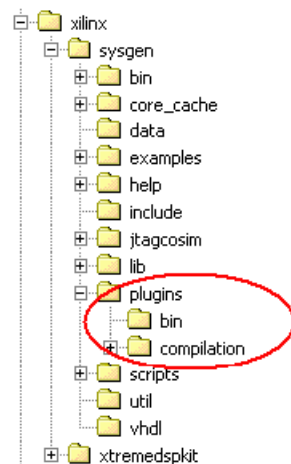

The board support package files for your board should be saved in a subdirectory, or series of subdirectories, under the `plugins/compilation` directory.

**Note:** All configuration files associated with a board support package must be saved in the same directory.

System Generator searches this directory (and subdirectories) for compilation targets. Recall that the `xltarget.m` file tells System Generator the board should be used as a compilation target. When the tool searches the `plugins/compilation` directory, it adds a compilation target to the System Generator token dialog box for every `xltarget.m` file that it encounters.

The System Generator token dialog box **Compilation** submenus mirror the directory structure under the `plugins/compilation` directory. When you create a new directory,

or directory hierarchy, for a board support package, the names of the directories define the taxonomy of the compilation target submenus.

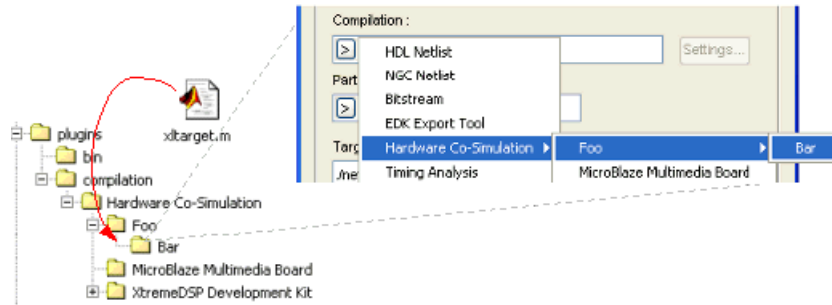

### Detecting New Packages

In order for System Generator to recognize the new target, you must tell it to search for new compilation targets by entering the following command in the MATLAB command window:

```
xlrehash_xltarget_cache
```

You can now select the FPGA board from the list of compilation targets in the System Generator token dialog box.

**Note:** If you have a System Generator token dialog box open when you enter this command, it will not show up until you close and re-open the dialog box.



## Importing HDL Modules

---

Sometimes it is important to add one or more existing HDL modules to a System Generator design. The System Generator Black Box block allows VHDL, Verilog, and EDIF to be brought into a design. The [Black Box](#) block behaves like other System Generator blocks - it is wired into the design, participates in simulations, and is compiled into hardware. When System Generator compiles a Black Box block, it automatically wires the imported module and associated files into the surrounding netlist.

Table 4-1:

<b>The Black Box Interface</b>	
<a href="#">Black Box HDL Requirements and Restrictions</a>	Details the requirements and restrictions for VHDL, Verilog, and EDIF associated with black boxes.
<a href="#">Black Box Configuration Wizard</a>	Describes how to use the Black Box Configuration Wizard.
<a href="#">Black Box Configuration M-Function</a>	Describes how to create a black box configuration M-function.

<b>HDL Co-Simulation</b>	
<a href="#">Configuring the HDL Simulator</a>	Explains how to configure ISE® Software or ModelSim to co-simulate the HDL in the Black Box block.
<a href="#">Co-Simulating Multiple Black Boxes</a>	Describes how to co-simulate several Black Box blocks in a single HDL simulator session.

<a href="#">Black Box Tutorial Example 1: Importing a Core Generator Module that Satisfies Black Box HDL Requirements</a>	Describes an approach that uses the System Generator Black Box Configuration Wizard.
<a href="#">Black Box Tutorial Example 2: Importing a Core Generator Module that Needs a VHDL Wrapper to Satisfy Black Box HDL Requirements</a>	Describes an approach that requires that you to provide a VHDL core wrapper. Simulation issues are also addressed.

<a href="#">Black Box Tutorial Example 3: Importing a VHDL Module</a>	Describes how to use the Black Box block to import VHDL into a System Generator design and how to use ModelSim to co-simulate.
<a href="#">Black Box Tutorial Example 4: Importing a Verilog Module</a>	Demonstrates how Verilog black boxes can be used in System Generator and co-simulated using ModelSim.
<a href="#">Black Box Tutorial Example 5: Dynamic Black Boxes</a>	Demonstrates dynamic black boxes using a transpose FIR filter black box that dynamically adjusts to changes in the widths of its inputs.
<a href="#">Black Box Tutorial Example 6: Simulating Several Black Boxes Simultaneously</a>	Demonstrates how several System Generator Black Box Blocks can be co-simulated simultaneously, using only one ModelSim license while doing so.
<a href="#">Black Box Tutorial Exercise 7: Advanced Black Box Example Using ModelSim</a>	Describes how to design a Black Box block with a dynamic port interface and how to configure a black box using mask parameters. Also, describes how to assign generic values based on input port data types and how to save black box blocks in Simulink libraries for later reuse. How to specify custom scripts for ModelSim HDL co-simulation is also covered.
<a href="#">Black Box Tutorial Example 8: Importing, Simulating, and Exporting an Encrypted VHDL File</a>	Describes how to import a design as an encrypted VHDL file into a Black Box block, simulate the design, then export the VHDL back out as a separate encrypted file from the rest of the netlist.
<a href="#">Black Box Tutorial Exercise 9: Prompting a User for Parameters in a Simulink Model and Passing Them to a Black Box</a>	Describes how to access generics/parameters from the masked counter and pass them onto the black box to override the default local parameters in the VHDL file.

## Black Box HDL Requirements and Restrictions

An HDL component associated with a black box must adhere to the following System Generator requirements and restrictions:

- The entity name must not collide with any other entity name in the design.
- Bi-directional ports are supported in HDL black boxes, however they will not be displayed in the System Generator as ports; they only appear in the generated HDL after netlisting.
- For Verilog black boxes, the module and port names must be lower case and must follow standard VHDL naming conventions.
- Any port that is a clock or clock enable must be of type `std_logic`. (For Verilog black boxes, ports must be of non-vector inputs, e.g., `input clk`.)
- Clock and clock enable ports in black box HDL should be expressed as follows: Clock and clock enables must appear as pairs (i.e., for every clock, there is a corresponding clock enable, and vice-versa). Although a black box may have more than one clock port, a single clock source is used to drive each clock port. Only the clock enable rates differ.
- Each clock name (respectively, clock enable name) must contain the substring `clk`, for example `my_clk_1` and `my_ce_1`.

- The name of a clock enable must be the same as that for the corresponding clock, but with `ce` substituted for `clk`. For example, if the clock is named `src_clk_1`, then the clock enable must be named `src_ce_1`.
- Falling-edge triggered output data cannot be used.

## Black Box Configuration Wizard

System Generator provides a configuration wizard that makes it easy to associate a VHDL or Verilog module to a Black Box block. The Configuration Wizard parses the VHDL or Verilog module that you are trying to import, and automatically constructs a configuration M-function based on its findings. It then associates the configuration M-function it produces to the Black Box block in your model. Whether or not you can use the configuration M-function as is depends on the complexity of the HDL you are importing. Sometimes the configuration M-function must be customized by hand to specify details the configuration wizard misses. Details on the construction of the configuration M-function can be found in the topic [Black Box Configuration M-Function](#).

### Using the Configuration Wizard

The Black Box Configuration Wizard opens automatically when a new black box block is added to a model.

**Note:** Before running the Configuration Wizard, ensure the VHDL or Verilog you are importing meets the specified [Black Box HDL Requirements and Restrictions](#).

For the Configuration Wizard to find your module, the model must be saved in the same directory as the module you are trying to import. This means, in particular, that the model must be saved to same directory.

**Note:** The wizard only searches for `.vhd` and `.v` files in the same directory as the `.mdl` file. If the wizard does not find any files it issues a warning and the black box is not automatically configured. The warning looks like the following:

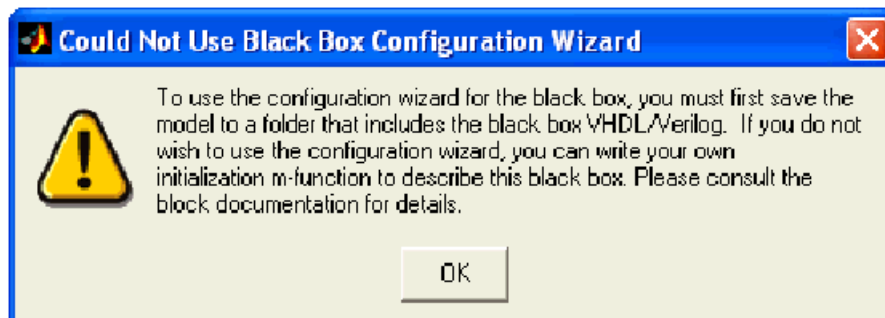

After searching the model's directory for .vhd and .v files, the Configuration Wizard opens a new window that lists the possible files that can be imported. An example screenshot is shown below:

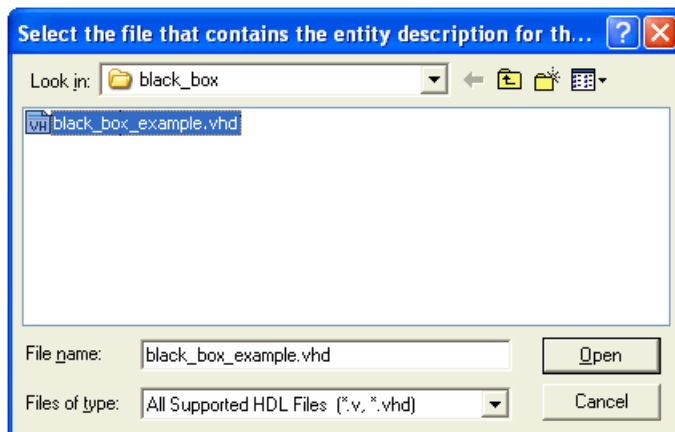

You can select the file you would like to import by selecting the file, and then pressing the **Open** button. At this point, the configuration wizard generates a configuration M-function and associates it with the black box block.

**Note:** The configuration M-function is saved in the model's directory as <module>\_config.m, where <module> is the name of the module that you are importing.

### Configuration Wizard Fine Points

The configuration wizard automatically extracts certain information from the imported module when it is run, but some things must be specified by hand. These things are described below:

**Note:** The configuration function is annotated with comments that instruct you where to make these changes.

- If your model has a combinational path, you must call the tagAsCombinational method of the block's SysgenBlockDescriptor object.
- The Configuration Wizard only knows about the top-level entity that is being imported. There are typically other files that go along with this entity. These files must be added manually in the configuration M-function by invoking the addFile method for each additional file.
- The Configuration Wizard creates a single-rate black box. This means that every port on the black box runs at the same rate. In most cases, this is acceptable. You may want to explicitly set port rates, which can result in a faster simulation time.

## Black Box Configuration M-Function

An imported module is represented in System Generator by a Black Box block. Information about the imported module is conveyed to the black box by a configuration M-function. This function defines the interface, implementation, and the simulation behavior of the black box block it is associated with. More specifically, the information a configuration M-function defines includes the following:

- Name of the top-level entity for the module;
- VHDL or Verilog language selection;



- Port descriptions;
- Generics required by the module;
- Clocking and sample rates;
- Files associated with the module;
- Whether the module has any combinational paths.

The name of the configuration M-function associated with a black box is specified as a parameter in the black box parameters dialog box (`parity_block_config.m` in the example shown below).

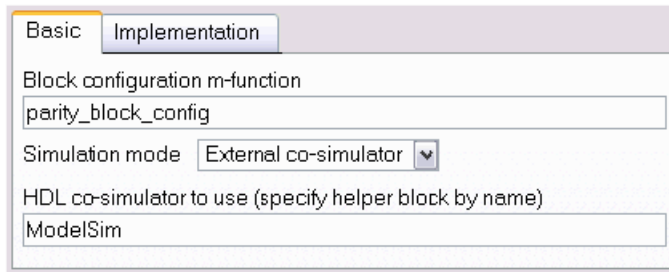

Configuration M-functions use an object-based interface to specify black box information. This interface defines two objects, `SysgenBlockDescriptor` and `SysgenPortDescriptor`. When System Generator invokes a configuration M-function, it passes the function a block descriptor:

```
function sample_block_config(this_block)
```

A `SysgenBlockDescriptor` object provides methods for specifying information about the black box. Ports on a block descriptor are defined separately using port descriptors.

## Language Selection

The black box can import VHDL and Verilog modules. `SysgenBlockDescriptor` provides a method, `setTopLevelLanguage`, that tells the black box what type of module you are importing. This method should be invoked once in the configuration M-function. The following code shows how to select between the VHDL and Verilog languages.

VHDL Module:

```
this_block.setTopLevelLanguage('VHDL');
```

Verilog Module:

```
this_block.setTopLevelLanguage('Verilog');
```

**Note:** The Configuration Wizard automatically selects the appropriate language when it generates a configuration M-function.

## Specifying the Top-Level Entity

You must tell the black box the name of the top-level entity that is associated with it. `SysgenBlockDescriptor` provides a method, `setEntityName`, which allows you to specify the name of the top-level entity.

**Note:** Use lower case text to specify the entity name.

For example, the following code specifies a top-level entity named `foo`.

```
this_block.setEntityName('foo');
```

**Note:** The Configuration Wizard automatically sets the name of the top-level entity when it generates a configuration M-function.

## Defining Block Ports

The port interface of a black box is defined by the block's configuration M-function. Recall that black box ports are defined using port descriptors. A port descriptor provides methods for configuring various port attributes, including port width, data type, binary point, and sample rate.

### Adding New Ports

When defining a black box port interface, it is necessary to add input and output ports to the block descriptor. These ports correspond to the ports on the module you are importing. In your model, the black box block port interface is determined by the port names that are declared on the block descriptor object. SysgenBlockDescriptor provides methods for adding input and output ports:

Adding an input port:

```
this_block.addSimulinkInport('din');
```

Adding an output port:

```
this_block.addSimulinkOutputport('dout');
```

The string parameter passed to methods `addSimulinkInport` and `addSimulinkOutputport` specifies the port name. These names should match the corresponding port names in the imported module.

**Note:** Use lower case text to specify port names.

Adding a bidirectional port:

```
config_phase = this_block.getConfigPhaseString;  
if (strcmpi(config_phase,'config_netlist_interface'))  
    this_block.addInoutport('bidi');  
    % Rate and type info should be added here as well  
end
```

Bi-directional ports are supported only during the netlisting of a design and will not appear on the System Generator diagram; they only appear in the generated HDL. As such, it is important to only add the bi-directional ports when System Generator is generating the HDL. The if-end conditional statement is guarding the execution of the code to add-in the bi-directional port.

It is also possible to define both the input and output ports using a single method call. The `setSimulinkPorts` method accepts two parameters. The first parameter is a cell array of strings that define the input port names for the block. The second parameter is a cell array of strings that define the output port names for the block.

**Note:** The Configuration Wizard automatically sets the port names when it generates a configuration M-function

### Obtaining a Port Object

Once a port has been added to a block descriptor, it is often necessary to configure individual attributes on the port. Before configuring the port, you must obtain a descriptor for the port you would like to configure. SysgenBlockDescriptor provides methods for

accessing the port objects that are associated with it. For example, the following method retrieves the port named `din` on the `this_block` descriptor:

Accessing a `SysgenPortDescriptor` object:

```
din = this_block.port('din');
```

In the above code, an object `din` is created and assigned to the descriptor returned by the `port` function call.

`SysgenBlockDescriptor` also provides methods, `inport` and `outport`, that return a port object given a port index. A port index is the index of the port (in the order shown on the block interface) and is some value between 1 and the number of input/output ports on the block. These methods are useful when you need to iterate through the block's ports (e.g., for error checking).

### Configuring Port Types

`SysgenPortDescriptor` provides methods for configuring individual ports. For example, assume port `dout` is unsigned, 12 bits, with binary point at position 8. The code below shows one way in which this type can be defined.

```
dout = this_block.port('dout');
dout.setWidth(12);
dout.setBinPt(8);
dout.makeUnsigned();
```

The following also works:

```
dout = this_block.port('dout');
dout.setType('Ufix_12_8');
```

The first code segment sets the port attributes using individual method calls. The second code segment defines the signal type by specifying the signal type as a string. Both code segments are functionally equivalent.

The black box supports HDL modules with 1-bit ports that are declared using either single bit port (e.g., `std_logic`) or vectors (e.g., `std_logic_vector(0 downto 0)`) notation. By default, System Generator assumes ports to be declared as vectors. You may change the default behavior using the `useHDLVector` method of the descriptor. Setting this method to `true` tells System Generator to interpret the port as a vector. A `false` value tells System Generator to interpret the port as single bit.

```
dout.useHDLVector(true); % std_logic_vector
dout.useHDLVector(false); % std_logic
```

**Note:** The Configuration Wizard automatically sets the port types when it generates a configuration M-function.

### Configuring Bi-Directional Ports for Simulation

Bi-directional ports (or inout ports) are supported only during the generation of the HDL netlist, that is, bi-directional ports will not show up in the System Generator diagram. By default, bi-directional ports will be driven with 'X' during simulation. It is possible to overwrite this behavior by associating a data file to the port. Be sure to guard this code since bi-directional ports can only be added to a block during the `config_netlist_interface` phase.

```
if
  (strcmpi(this_block.getConfigPhaseString,'config_netlist_interface'))
  bidi_port = this_block.port('bidi');
```

```
bidi_port.setGatewayFileName('bidi.dat');
end
```

In the above example, a text file "bidi.dat" is used during simulation to provide stimulation to the port. The data file should be a text file, where each line represents the signal driven on the port at each simulation cycle. For example, a 3-bit bi-directional port that is simulated for 4 cycles might have the following data file:

```
ZZZ
110
011
XXX
```

Simulation will return with an error if the specified data file cannot be found.

### Configuring Port Sample Rates

The black box block supports ports that have different sample rates. By default, the sample rate of an output port is the sample rate inherited from the input port (or ports, if the inputs run at the same sample rate). Sometimes it is necessary to explicitly specify the sample rate of a port (e.g., if the output port rate is different than the block's input sample rate).

**Note:** When the inputs to a black box have different sample rates, you must specify the sample rates of every output port.

SysgenPortDescriptor provides a method, `setRate`, which allows you to explicitly set the rate of a port.

**Note:** The rate parameter passed to the `setRate` method is not necessarily the Simulink sample rate of that the port runs at. Instead, it is a positive Integer value that defines the ratio between the desired port sample period and the Simulink system clock period defined by the System Generator token dialog box.

Assume you have a model in which the Simulink system period value for the model is defined as 2 sec. Also assume, the example `dout` port is assigned a rate of 3 by invoking the `setRate` method as follows:

```
dout.setRate(3);
```

A rate of 3 means that a new sample is generated on the `dout` port every 3 Simulink system periods. Since the Simulink system period is 2 sec, this means the Simulink sample rate of the port is  $3 \times 2 = 6$  sec.

**Note:** If your port is a non-sampled constant, you may define it as so in the configuration M-function using the `setConstant` method of SysgenPortDescriptor. You can also define a constant by passing `Inf` to the `setRate` method.

### Dynamic Output Ports

A useful feature of the black box is its ability to support dynamic output port types and rates. For example, it is often necessary to set an output port width based on the width of an input port. SysgenPortDescriptor provides member variables that allow you to determine the configuration of a port. You can set the type or rate of an output port by examining these member variables on the block's input ports.

For example, you can obtain the width and rate of a port (in this case `din`) as follows:

```
input_width = this_block.port('din').width;
input_rate  = this_block.port('din').rate;
```

**Note:** A black box's configuration M-function is invoked at several different times when a model is compiled. The configuration function may be invoked before the data types and rates have been propagated to the black box.

The SysgenBlockDescriptor object provides Boolean member variables `inputTypesKnown` and `inputRatesKnown` that tell whether the port types and rates have been propagated to the block. If you are setting dynamic output port types or rates based on input port configurations, the configuration calls should be nested inside conditional statements that check that values of `inputTypesKnown` and `inputRatesKnown`.

The following code shows how to set the width of a dynamic output port `dout` to have the same width as input port `din`:

```
if (this_block.inputTypesKnown)
    dout.setWidth(this_block.port('din').width);
end
```

Setting dynamic rates works in a similar manner. The code below sets the sample rate of output port `dout` to be twice as slow as the sample rate of input port `din`:

```
if (this_block.inputRatesKnown)
    dout.setRate(this_block.port('din').rate*2);
end
```

## Black Box Clocking

In order to import a multirate module, you must tell System Generator information about the module's clocking in the configuration M-function. System Generator treats clock and clock enables differently than other types of ports. A clock port on an imported module must always be accompanied by a clock enable port (and vice versa). In other words, clock and clock enables must be defined as a pair, and exist as a pair in the imported module. This is true for both single rate and multirate designs.

**Note:** Although clock and clock enables must exist as pairs, System Generator drives all clock ports on your imported module with the FPGA system clock. The clock enable ports are driven by clock enable signals derived from the FPGA system clock.

SysgenBlockDescriptor provides a method, `addClkCEPair`, which allows you to define clock and clock enable information for a black box. This method accepts three parameters. The first parameter defines the name of the clock port (as it appears in the module). The second parameter defines the name of the clock enable port (also as it appears in the module).

The port names of a clock and clock enable pair must follow the naming conventions provided below:

- The clock port must contain the substring `clk`
- The clock enable must contain the substring `ce`
- The strings containing the substrings `clk` and `ce` must be the same (e.g., `my_clk_1` and `my_ce_1`).

The third parameter defines the rate relationship between the clock and the clock enable port. The rate parameter should not be thought of as a Simulink sample rate. Instead, this parameter tells System Generator the relationship between the clock sample period, and the desired clock enable sample period. The rate parameter is an integer value that defines the ratio between the clock rate and the corresponding clock enable rate.

For example, assume you have a clock enable port named `ce_3` that would like to have a period three times larger than the system clock period. The following function call establishes this clock enable port:

```
addClkCEPair('clk_3','ce_3',3);
```

When System Generator compiles a black box into hardware, it produces the appropriate clock enable signals for your module, and automatically wires them up to the appropriate clock enable ports.

## Combinational Paths

If the module you are importing has at least one combinational path (i.e., a change on any input can effect an output port without a clock event), you must indicate this in the configuration M-function. SysgenBlockDescriptor object provides a `tagAsCombinational` method that indicates your module has a combinational path. It should be invoked as follows in the configuration M-function:

```
this_block.tagAsCombinational;
```

## Specifying VHDL Generics and Verilog Parameters

You may specify a list of generics that get passed to the module when System Generator compiles the model into HDL. Values assigned to these generics can be extracted from mask parameters and from propagated port information (e.g., port width, type, and rate). This flexible means of generic assignment allows you to support highly parametric modules that are customized based on the Simulink environment surrounding the black box.

The `addGeneric` method allows you to define the generics that should be passed to your module when the design is compiled into hardware. The following code shows how to set a VHDL Integer generic, `dout_width`, to a value of 12.

```
addGeneric('dout_width', 'Integer', '12');
```

It is also possible to set generic values based on port or propagated input port information (e.g., a generic specifying the width of a dynamic output port).

Because a black box's configuration M-function is invoked at several different times when a model is compiled, the configuration function may be invoked before the data types (or rates) have been propagated to the black box. If you are setting generic values based on input port types or rates, the `addGeneric` calls should be nested inside a conditional statement that checks the value of the `inputTypesKnown` or `inputRatesKnown` variables. For example, the width of the `dout` port can be set based on the value of `din` as follows:

```
if (this_block.inputTypesKnown)
    % set generics that depend on input port types
    this_block.addGeneric('dout_width', ...
        this_block.port('din').width);
end
```

Generic values can be configured based on mask parameters associated with a block box. SysgenBlockDescriptor provides a member variable, `blockName`, which is a string representation of the black box's name in Simulink. You may use this variable to gain access the black box associated with the particular configuration M-function. For example, assume a black box defines a parameter named `init_value`. A generic with name `init_value` can be set as follows:

```
simulink_block = this_block.blockName;
init_value = get_param(simulink_block, 'init_value');
this_block.addGeneric('init_value', 'String', init_value);
```

**Note:** You can add your own parameters (e.g., values that specify generic values) to the black box by doing the following:

- Copy a black box into a Simulink library or model;
- Break the link on the black box;
- Add the desired parameters to the black box dialog box.

## Black Box VHDL Library Support

This Black Box feature allow you to import VHDL modules that have predefined library dependencies. The following example illustrates how to do this import.

The VHDL module below is a 4-bit, Up counter with asynchronous clear (async\_counter.vhd). It will be compiled into a library named **async\_counter\_lib**.

```

1  -- 4-bit, Up counter, with asynchronous clear
2  library ieee;
3  use ieee.std_logic_1164.all;
4  use ieee.std_logic_unsigned.all;
5  entity async_counter is
6  port(clk, clr : in std_logic;
7        ce: in std_logic := '1'; |
8        q : out std_logic_vector(3 downto 0));
9  end async_counter;
10 architecture archi of async_counter is
11     signal tmp: std_logic_vector(3 downto 0);
12 begin
13     process (clk, clr)
14     begin
15         if (clr='1') then
16             tmp <= "0000";
17         elsif (clk'event and clk='1') then
18             tmp <= tmp + 1;
19         end if;
20     end process;
21     q <= tmp;
22 end archi;

```

The VHDL module below is a 4-bit, Up counter with synchronous clear (sync\_counter.vhd). It will be compiled into a library named **sync\_counter\_lib**.

```

1  -- 4-bit, Up counter, with synchronous clear
2  library ieee;
3  use ieee.std_logic_1164.all;
4  use ieee.std_logic_unsigned.all;
5
6  entity sync_counter is
7  port(clk, clr : in std_logic;
8        ce: in std_logic := '1'; |
9        q : out std_logic_vector(3 downto 0));
10 end sync_counter;
11 architecture archi of sync_counter is
12     signal tmp: std_logic_vector(3 downto 0);
13 begin
14     process (clk)
15     begin
16         if (clk'event and clk='1') then
17             if (clr='1') then
18                 tmp <= "0000";
19             else
20                 tmp <= tmp + 1;
21             end if;
22         end if;
23     end process;
24     q <= tmp;
25 end archi;

```

The VHDL module below is the top-level module that is used to instantiate the previous modules. This is the module that you need to point to when adding the BlackBox into your System Generator model.

```

1  library ieee;
2  use ieee.std_logic_1164.all;
3  use ieee.std_logic_unsigned.all;
4  library sync_counter_lib;
5  use sync_counter_lib.all;
6  library async_counter_lib;
7  use async_counter_lib.all;
8
9
10 entity top_level is
11 port (clk, clr : in std_logic;
12       ce: in std_logic := '1';
13       q_sync : out std_logic_vector(3 downto 0);
14       q_async : out std_logic_vector(3 downto 0)
15       );
16 end top_level;
17
18 architecture structural of top_level is
19 component async_counter
20 port (
21     clk, clr, ce: in std_logic;
22     q: out std_logic_vector(3 downto 0));
23 end component;
24
25 component sync_counter
26 port (
27     clk, clr, ce: in std_logic;
28     q: out std_logic_vector(3 downto 0));
29 end component;
30
31 begin
32 counter_0: entity async_counter_lib.async_counter
33 port map (
34     ce => ce,
35     q  => q_async,
36     clk => clk,
37     clr => clr
38 );
39 counter_1: entity sync_counter_lib.sync_counter
40 port map (
41     ce => ce,
42     q  => q_sync,
43     clk => clk,
44     clr => clr
45 );
46 end structural;

```

Define libraries using "library" and "use" clauses

The VHDL is imported by first importing the top-level entity, **top\_level**, using the Black Box.



Once the file is imported, the associated Black Box Configuration M-file needs to be modified as follows:

```

% Add additional source files as needed.
% |-----
% | Add files in the order in which they should be compiled.
% | If two files "a.vhd" and "b.vhd" contain the entities
% | entity_a and entity_b, and entity_a contains a
% | component of type entity_b, the correct sequence of
% | addFile() calls would be:
% |   this_block.addFile('b.vhd');
% |   this_block.addFile('a.vhd');
% |-----
%   this_block.addFile('');
%   this_block.addFile('');
this_block.addFile('top.vhd');
this_block.addFileToLibrary('async_counter.vhd','async_counter_lib');
this_block.addFileToLibrary('sync_counter.vhd','sync_counter_lib');
    
```

Specifying library names by using  
"addFileToLibrary" command

The interface function **addFileToLibrary** is used to specify a library name other than "work" and to instruct the tool to compile the associated HDL source to the specified library.

The System Generator model should look similar to the figure below.

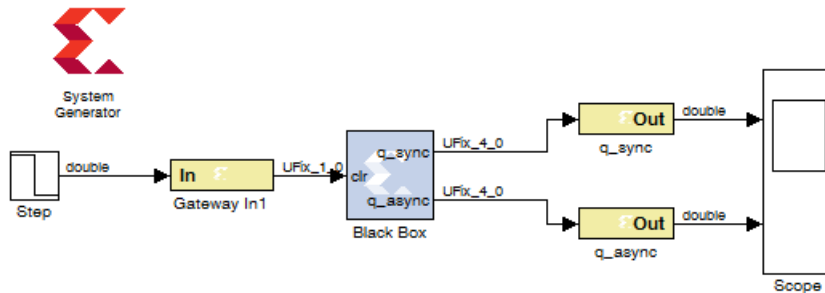

The next step is to double-click on the System Generator token and click on the **Generate** button to generate the HDL netlist.

During the generation process, an ISE project file is created and placed in the netlist folder. To verify that each VHDL sub-module was compiled into its own library, double click on the ISE project file to bring up Project Navigator. Select the **Libraries** tab and you will see that not only is there a **work** library, but a **async\_counter\_lib** library and a **sync\_counter\_lib** library as well.

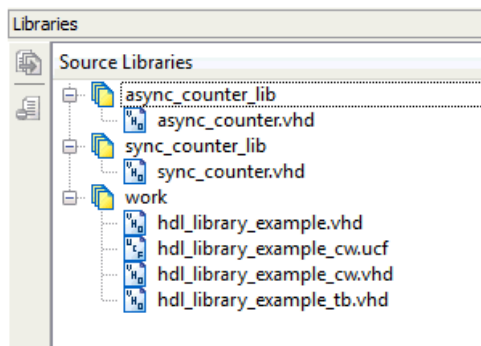

## Error Checking

It is often necessary to perform error checking on the port types, rates, and mask parameters of a black box. SysgenBlockDescriptor provides a method, `setError`, which allows you to specify an error message that is reported to the user. The string parameter passed to `setError` is the error message that is seen by user.

## Black Box API

### SysgenBlockDescriptor Member Variables

Type	Member	Description
String	<code>entityName</code>	Name of the entity or module.
String	<code>blockName</code>	Name of the black box block.
Integer	<code>numSimulinkInports</code>	Number of input ports on black box.
Integer	<code>numSimulinkOutports</code>	Number of output ports on the black box.
Boolean	<code>inputTypesKnown</code>	true if all input types are defined, and false otherwise.
Boolean	<code>inputRatesKnown</code>	true if all input rates are defined, and false otherwise.
Array of Doubles	<code>inputRates</code>	Array of sample periods for the input ports (indexed as in <code>inport(indx)</code> ). Sample period values are expressed as integer multiples of the Simulink System Period value specified by the master System Generator token
Boolean	<code>error</code>	true if an error has been detected, and false otherwise.
Cell Array of Strings	<code>errorMessages</code>	Array of all error messages for this block.

### SysgenBlockDescriptor Methods

Method	Description
setTopLevelLanguage(language)	Declares language for the top-level entity (or module) of the black box. language should be 'VHDL' or 'Verilog'.
setEntityName(name)	Sets name of the entity or module.
addSimulinkInport(pname)	Adds an input port to the black box. pname tells the name the port should have.
addSimulinkOutport(pname)	Adds an output port to the black box. pname tells the name the port should have.
setSimulinkPorts(in,out)	Adds input and output ports to the black box. in (respectively, out) is a cell array whose element tell the names to use for the input (resp., output) ports.
addInoutport(pname)	Adds a bi-directional port to the black box. pname specifies the name the port should have. Bi-directional ports can only be added during the 'config_netlist_interface' phase of configuration.
tagAsCombinational()	Indicate that the block has a combinational path (i.e., direct feedthrough) from an input port to an output port.
addClkCEPair(clkPname, cePname, rate)	Defines a clock/clock enable port pair for the block. clkPname and cePname tell the names for the clock and clock enable ports respectively. rate, a double, tells the rate at which the port pair runs. The rate must be a positive integer. Note the clock (respectively, clock enable) name must contain the substring clk (resp., ce). The names must be parallel in the sense that the clock enable name is obtained from the clock name by replacing clk with ce.
port(name)	Returns the SysgenPortDescriptor that matches the specified name.
inport(indx)	Returns the SysgenPortDescriptor that describes a given input port. indx tells the index of the port to look for, and should be between 1 and numInputPorts.
outport(indx)	Returns the SysgenPortDescriptor that describes a given output port. indx tells the index of the port to look for, and should be between 1 and numOutputPorts.

Method	Description
addGeneric(identifier, value)	Defines a generic (or parameter if using Verilog) for the block. identifier is a string that tells the name of the generic. value can be a double or a string. The type of the generic is inferred from value's type. If value is an integral double, e.g., 4.0, the type of the generic is set to integer. For a non-integral double, the type is set to real. When value is a string containing only zeros and ones, e.g., '0101', the type is set to bit_vector. For any other string value the type is set to string.
addGeneric(identifier, type, value)	Explicitly specifies the name, type, and value for a generic (or parameter if using Verilog) for the block. All three arguments are strings. identifier tells the name, type tells the type, and value tells the value.
addFile(fn)	Adds a file name to the list of files associated to this black box. fn is the file name. Ordinarily, HDL files are associated to black boxes, but any sorts of files are acceptable. VHDL (respectively, Verilog) file names should end in .vhd (resp., .v). The order in which file names are added is preserved, and becomes the order in which HDL files are compiled. File names can be absolute or relative. Relative file names are interpreted with respect to the location of the .mdl or library .mdl for the design.
getDeviceFamilyName()	Gets the name of the FPGA device corresponding to the Blackbox.
getConfigPhaseString	Returns the current configuration phase as a string. A valid return string includes: config_interface, config_rate_and_type, config_post_rate_and_type, config_simulation, config_netlist_interface and config_netlist.
setSimulatorCompilationScript (script)	Overrides the default HDL co-simulation compilation script that the black box generates. script tells the name of the script to use. This method can, for example, be used to short-circuit the compilation phase for repeated simulations where the HDL for the black box remains unchanged.
setError(message)	Indicates that an error has occurred, and records the error message. message gives the error message.

### SysgenPortDescriptor Member Variables

Type	Member	Description
String	name	Tells the name of the port.
Integer	simulinkPortNumber	Tells the index of this port in Simulink. Indexing starts with 1 (as in Simulink).
Boolean	typeKnown	True if this port's type is known, and false otherwise.
String	type	Type of the port, e.g., UFix_<n>_<b>, Fix_<n>_<b>, or Bool
Boolean	isBool	True if port type is Bool, and false otherwise.
Boolean	isSigned	True if type is signed, and false otherwise.
Boolean	isConstant	True if port is constant, and false otherwise.
Integer	width	Tells the port width.
Integer	binpt	Tells the binary point position, which must be an integer in the range 0..width.
Boolean	rateKnown	True if the rate is known, and false otherwise.
Double	rate	Tells the port sample time. Rates are positive integers expressed as MATLAB doubles. A rate can also be infinity, indicating that the port outputs a constant.

### SysgenPortDescriptor Methods

Method	Description
setName(name)	Sets the HDL name to be used for this port.
setSimulinkPortNumber(num)	Sets the index associated with this port in Simulink. num tells the index to assign. Indexing starts with 1 (as in Simulink).
setType(typeName)	Sets the type of this port to type. Type must be one of Bool, UFix_<n>_<b>, Fix_<n>_<b>, signed or unsigned. The last two choices leave the width and binary point position unchanged.
setWidth(w)	Sets the width of this port to w.
setBinpt(bp)	Sets the binary point position of this port to bp.
makeBool()	Makes this port Boolean.
makeSigned()	Makes this port signed.
makeUnsigned()	Makes this port unsigned.

Method	Description
setConstant()	Makes this port constant
setGatewayFileName(filename)	Sets the dat file name that will be used in simulations and test-bench generation for this port. This function is only meant for use with bi-directional ports so that a hand written data file can be used during simulation. Setting this parameter for input or output ports is invalid and will be ignored.
setRate(rate)	Assigns the rate for this port. rate must be a positive integer expressed as a MATLAB double or Inf for constants.
useHDLVector(s)	Tells whether a 1-bit port is represented as single-bit (ex: std_logic) or vector (ex: std_logic_vector(0 downto 0)).
HDLTypeIsVector()	Sets representation of the 1-bit port to std_logic_vector(0 downto 0).

## HDL Co-Simulation

### Introduction

This topic describes how a mixed language/mixed flow design that includes Xilinx blocks, HDL modules, and a Simulink block diagram can be simulated in its entirety.

System Generator simulates black boxes by automatically launching an HDL simulator, generating additional HDL as needed (analogous to an HDL testbench), compiling HDL, scheduling simulation events, and handling the exchange of data between the Simulink and the HDL simulator. This is called *HDL co-simulation*.

### Configuring the HDL Simulator

Black box HDL can be co-simulated with Simulink using the System Generator interface to either ISE® Simulator or the ModelSim simulation software from Model Technology, Inc.

#### ISE Simulator

To use the ISE® Simulator for co-simulating the HDL associated with the black box, select **ISE Simulator** as the option for the **Simulation mode** parameter on the black box as shown in the following figure. The model is then ready to be simulated and the HDL co-simulation takes place automatically.

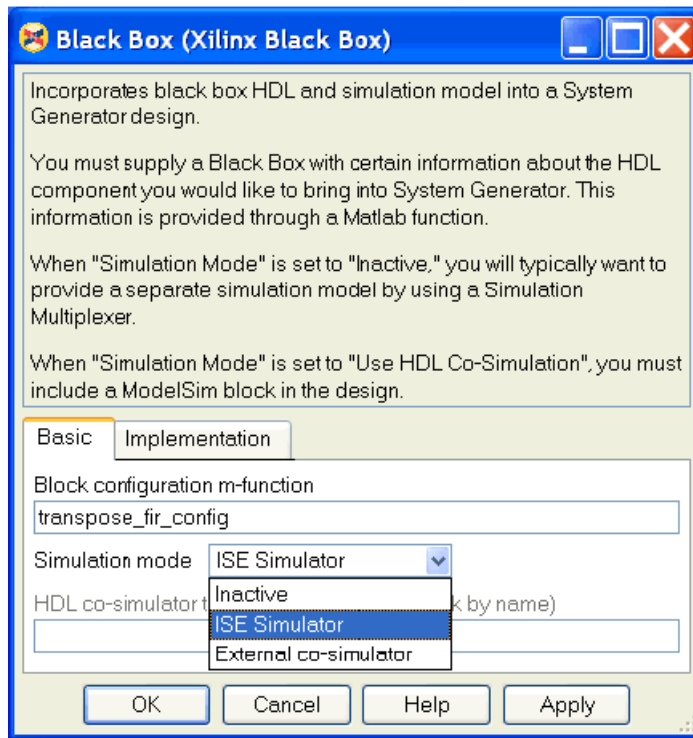

## ModelSim Simulator

To use the ModelSim simulator by Model Technology, Inc., you must first add the ModelSim block that appears in the Tools library of the Xilinx Blockset to your Simulink diagram.



For each black box that you wish to have co-simulated using ModelSim simulator, you need to open its block parameterization dialog and set it to use the ModelSim session represented by the black box that was just added. You do this by making the following two settings:

1. Change the Simulation Mode field from Inactive to External co-simulator.
2. Enter the name of the ModelSim block (e.g., ModelSim) in the HDL Co-Simulator to use field.

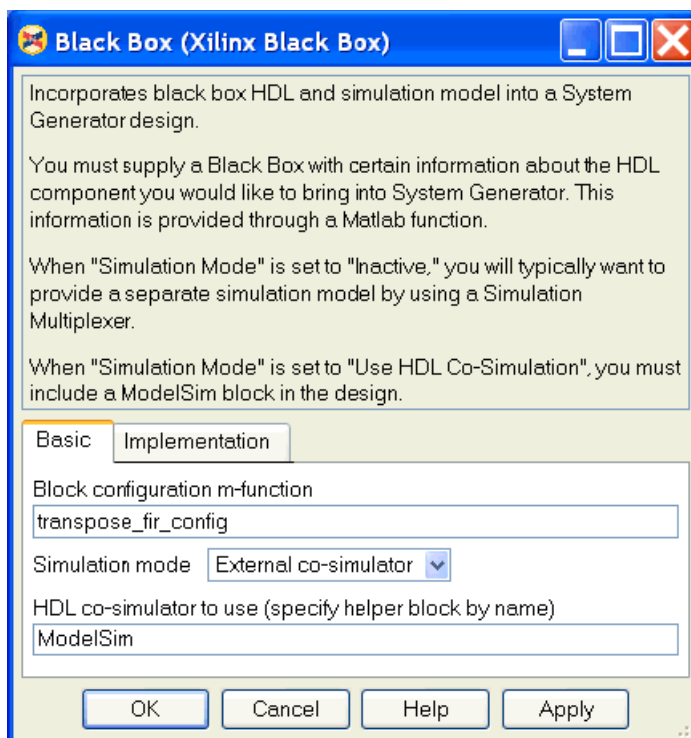

The block parameter dialog for the ModelSim block includes some parameters that you can use to control various options for the ModelSim session. See the [Modelsim](#) block help pages for details. The model is then ready to be simulated with these options, and the HDL co-simulation takes place automatically.

## Co-Simulating Multiple Black Boxes

System Generator allows many black boxes to share a common ModelSim co-simulation session. I.e., many black boxes can be set to "use" the same ModelSim block. In this case, System Generator automatically combines all black box HDL components into a single shared top-level co-simulation component. This is transparent to the user. It does mean, however, that only one ModelSim simulation license is needed to co-simulate several black boxes in the Simulink simulation.

For an example of how to do this, see [Simulating Several Black Boxes Simultaneously](#).

Multiple black boxes can also be co-simulated with ISE® Simulator by just selecting *ISE Simulator* as the option for *Simulation mode* on each black box.



## Black Box Examples

<a href="#">Black Box Tutorial Example 1: Importing a Core Generator Module that Satisfies Black Box HDL Requirements</a>	Describes an approach that uses the System Generator Black Box Configuration Wizard.
<a href="#">Black Box Tutorial Example 2: Importing a Core Generator Module that Needs a VHDL Wrapper to Satisfy Black Box HDL Requirements</a>	Describes an approach that requires that you to provide a VHDL core wrapper. Simulation issues are also addressed.
<a href="#">Black Box Tutorial Example 3: Importing a VHDL Module</a>	Describes how to use the Black Box block to import VHDL into a System Generator design and how to use ModelSim to co-simulate.
<a href="#">Black Box Tutorial Example 4: Importing a Verilog Module</a>	Demonstrates how Verilog black boxes can be used in System Generator and co-simulated using ModelSim.
<a href="#">Black Box Tutorial Example 5: Dynamic Black Boxes</a>	Demonstrates dynamic black boxes using a transpose FIR filter black box that dynamically adjusts to changes in the widths of its inputs.
<a href="#">Black Box Tutorial Example 6: Simulating Several Black Boxes Simultaneously</a>	Demonstrates how several System Generator Black Box Blocks can be co-simulated simultaneously, using only one ModelSim license while doing so.
<a href="#">Black Box Tutorial Exercise 7: Advanced Black Box Example Using ModelSim</a>	Describes how to design a Black Box block with a dynamic port interface and how to configure a black box using mask parameters. Also, describes how to assign generic values based on input port data types and how to save black box blocks in Simulink libraries for later reuse. How to specify custom scripts for ModelSim HDL co-simulation is also covered.
<a href="#">Black Box Tutorial Example 8: Importing, Simulating, and Exporting an Encrypted VHDL File</a>	Describes how to import an encrypted VHDL file into a Black Box, simulate the design, then export the encrypted VHDL file separately from the rest of the design netlist.
<a href="#">Black Box Tutorial Exercise 9: Prompting a User for Parameters in a Simulink Model and Passing Them to a Black Box</a>	Describes how to access generics/parameters from the masked counter and pass them onto the black box to override the default local parameters in the VHDL file.

### Importing a Xilinx Core Generator Module

This topic describes two different ways of importing Xilinx CORE Generator™ modules, as black boxes, into System Generator. The first example shows how to import blocks which satisfy [Black Box HDL Requirements and Restrictions](#). The second example shows

how to write a VHDL wrapper to import CORE Generator™ modules as black boxes. The flow graph below illustrates the process of importing CORE generator modules.

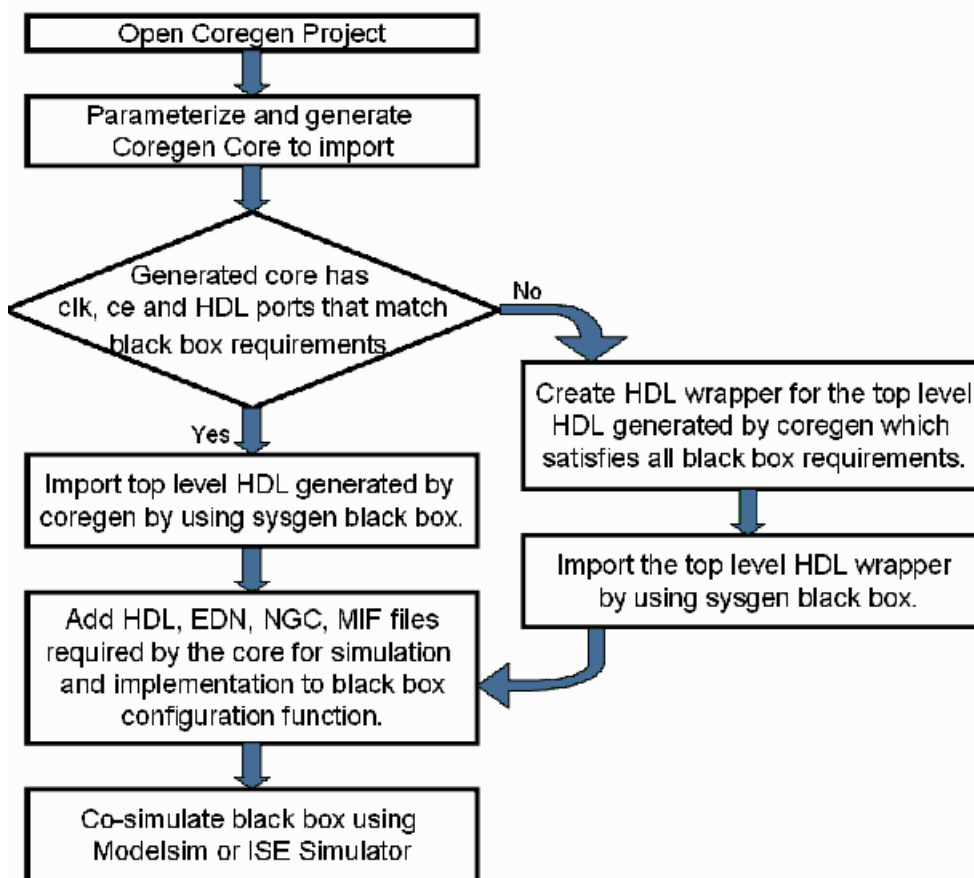

### Black Box Tutorial Example 1: Importing a Core Generator Module that Satisfies Black Box HDL Requirements

1. Start CORE Generator and open the the following CORE Generator project file:  
`<ISE_Design_Suite_tree>/sysgen/examples/coregen_import/example1/coregen_import_example1.cgp`

2. Double click the CORDIC 4.0 icon to launch the customization GUI

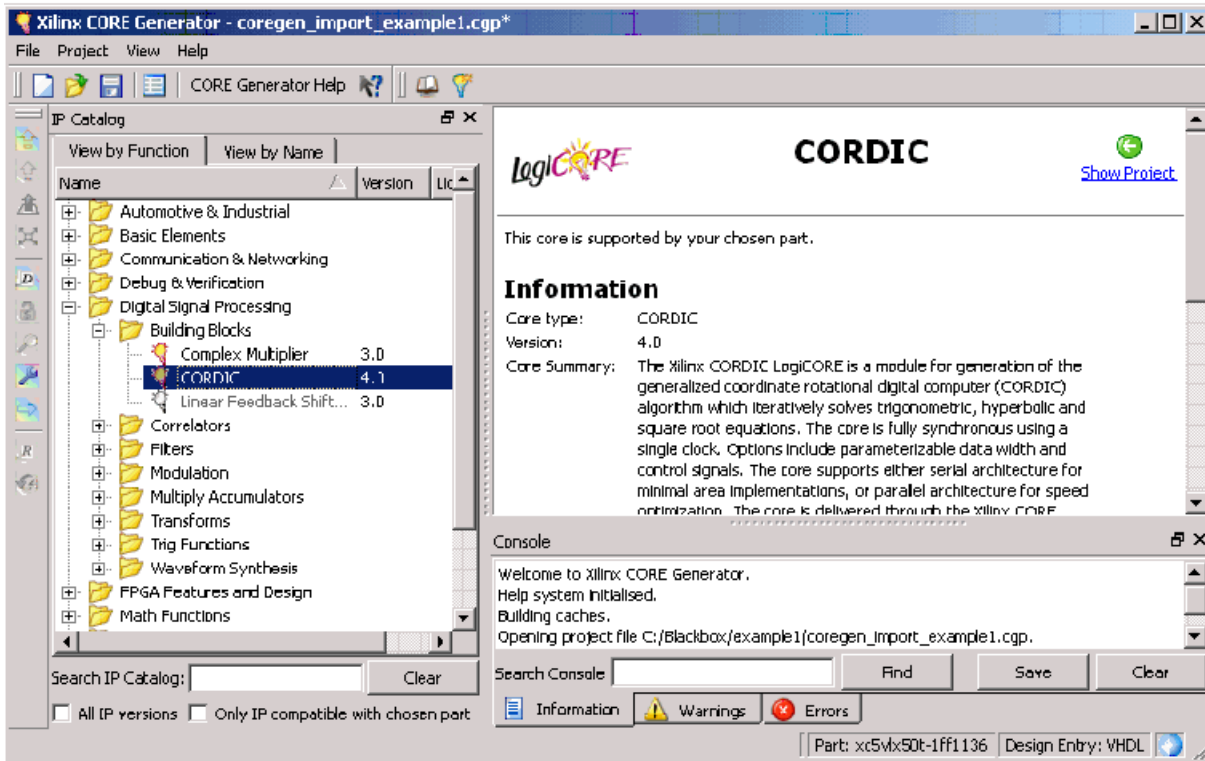

3. Parameterize and generate the CORDIC 4.0 core with component name `cordic_sincos`, a functional Selection of **Sin and Cos** and the remaining options set to be the default values as shown below:

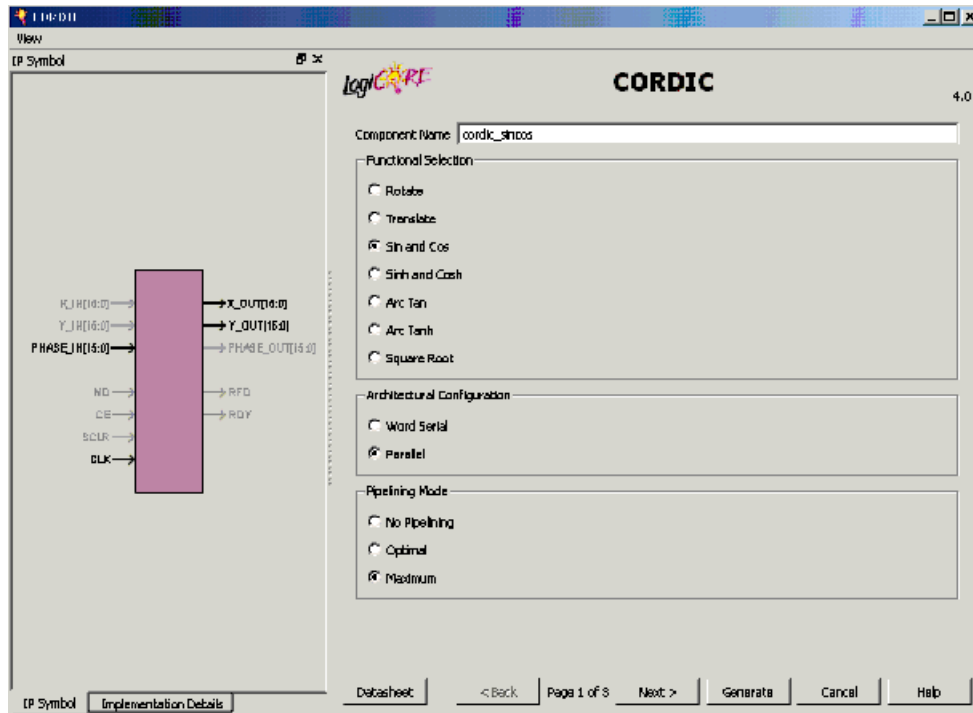

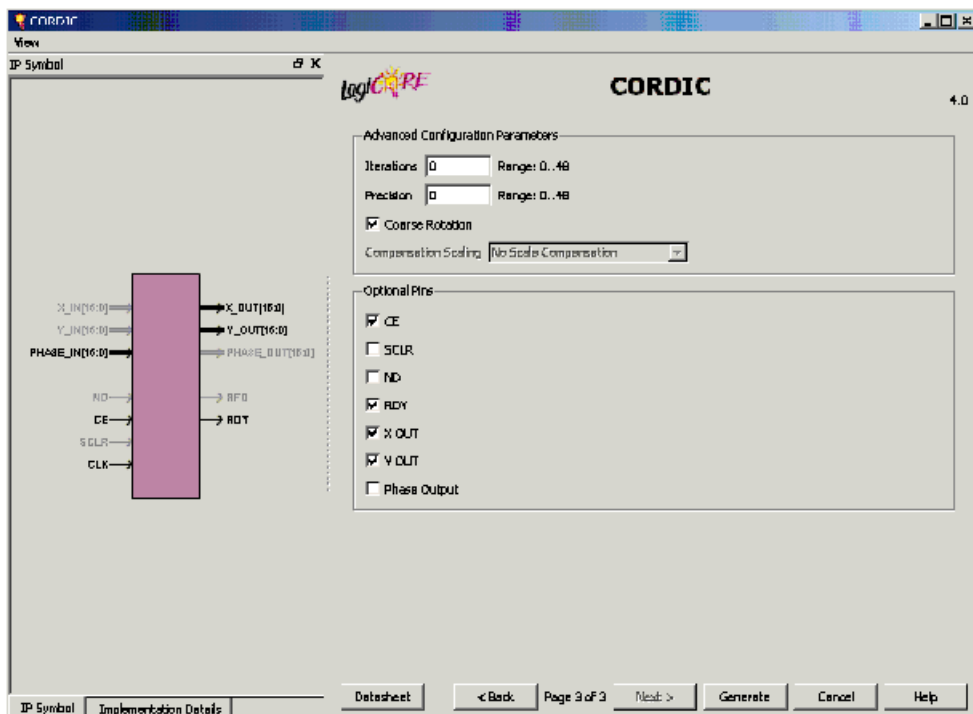
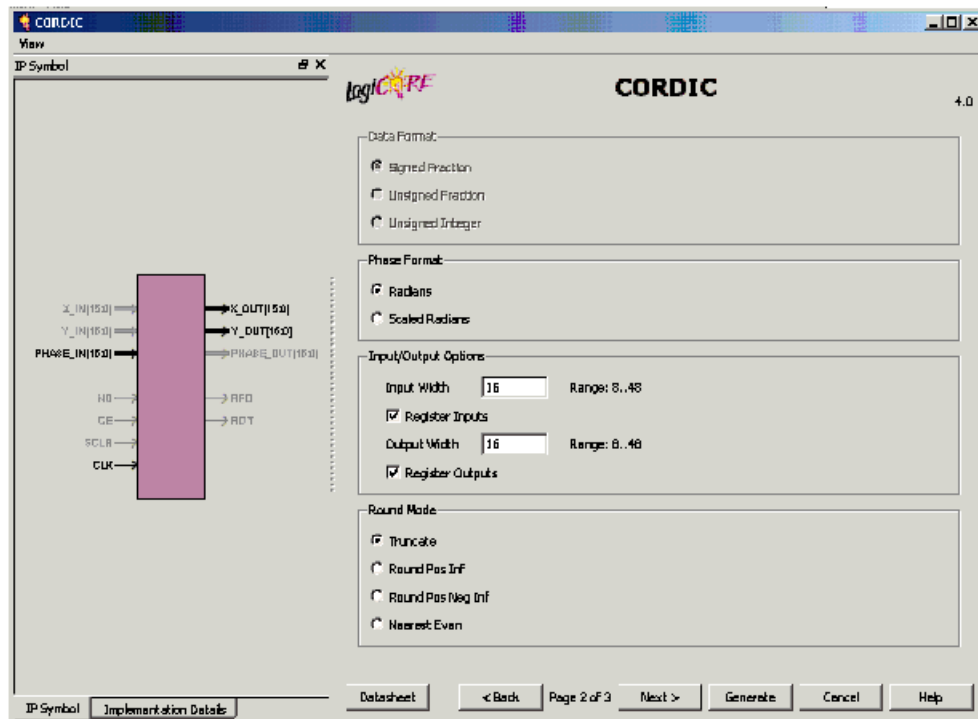

4. Click **Generate**. Core Generator produces the following files after generation:
  - ◆ cordic\_sincos.ngc: Implementation netlist
  - ◆ cordic\_sincos.vhd: VHDL wrapper for behavioral simulation
  - ◆ cordic\_sincos.vho: Core instantiation template
  - ◆ cordic\_sincos.xco: Parameters selected for core generation
5. Start Simulink and open the design file  
(<ISE\_Design\_Suite\_tree>/sysgen/examples/coregen\_import/example1/coregen\_import\_example1.mdl)
6. Drag and drop the black box from the Xilinx "Basic Elements" library into the model coregen\_import\_example1.mdl. Select cordic\_sincos.vhd for the top-level HDL file and click **Open**.

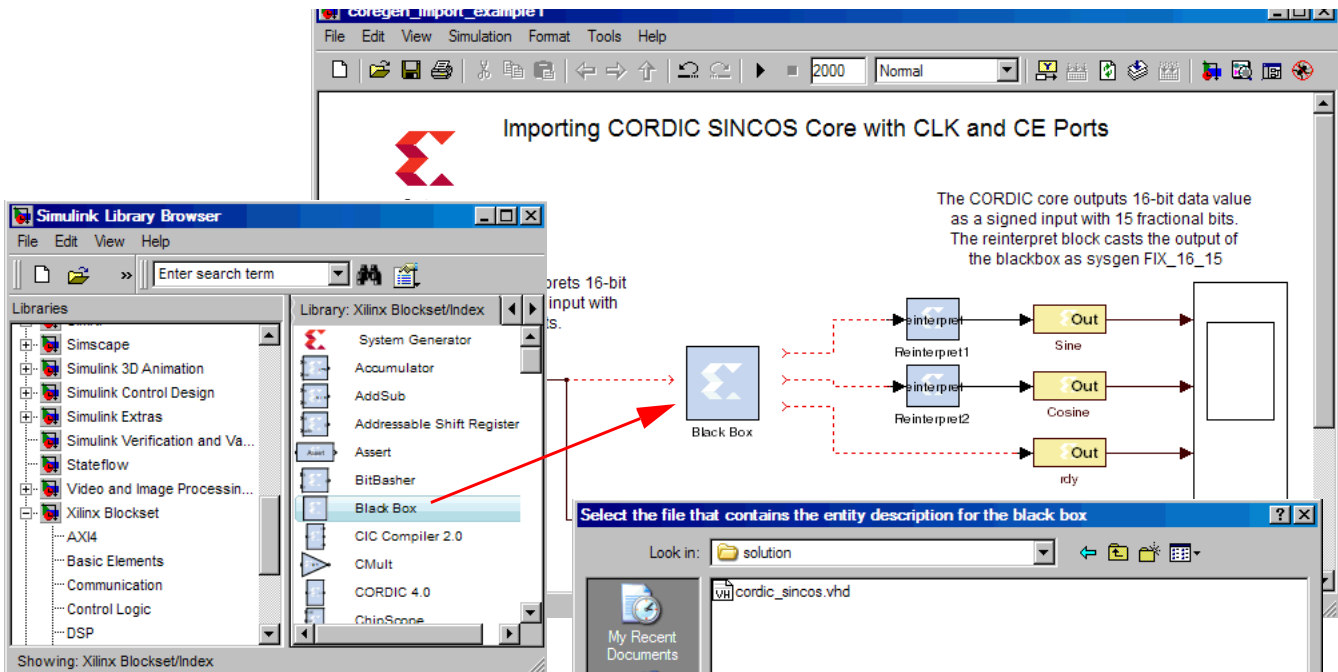

7. Connect the input and output ports of the black box to the open wires.

8. Open the `cordic_sincos_config.m` file, and add the EDIF netlist to the black box file list as shown below. This file will get included as part of the System Generator netlist for the design when it is netlisted.

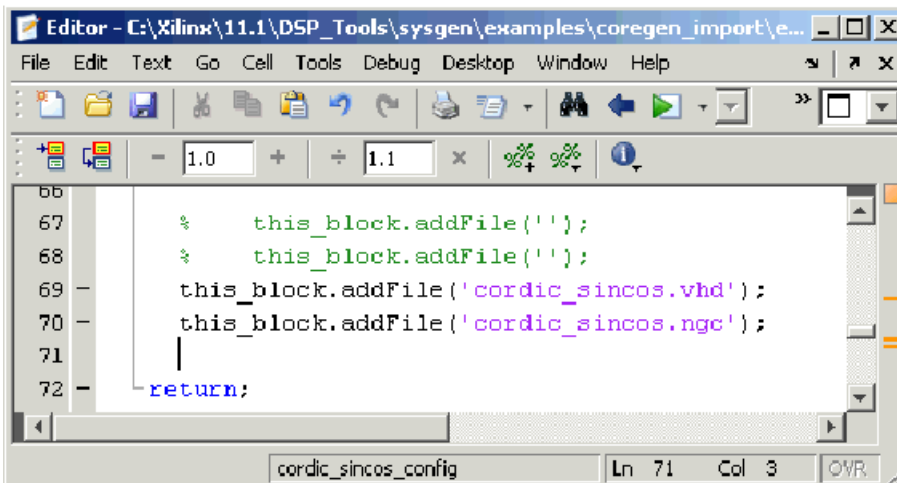

```

66
67     %     this_block.addFile('');
68     %     this_block.addFile('');
69 -    this_block.addFile('cordic_sincos.vhd');
70 -    this_block.addFile('cordic_sincos.ngc');
71     |
72 -    return;

```

9. Open the black box parameterization GUI and select **ISE Simulator** for the simulation mode.

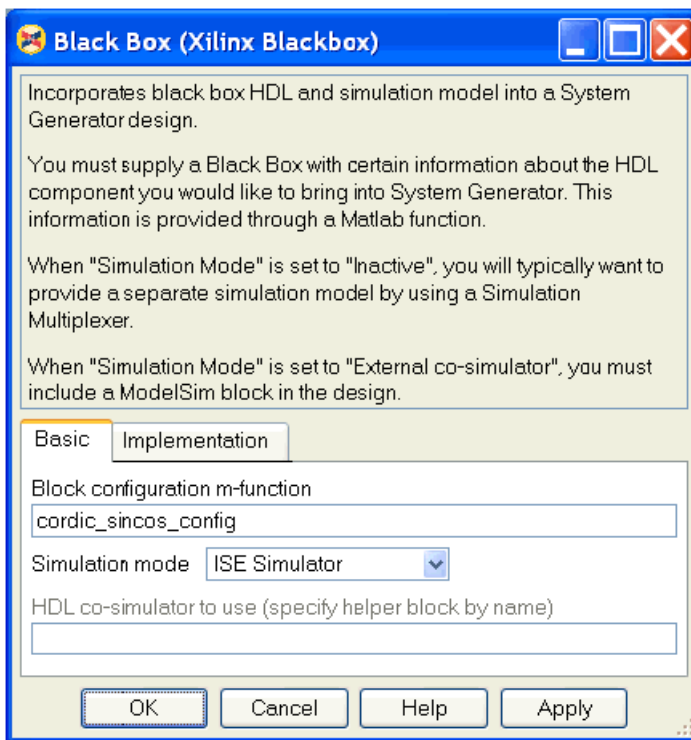

- Press the **Simulate** button to compile and co-simulate the CORDIC core using the ISE simulator. The simulation results are as shown below.

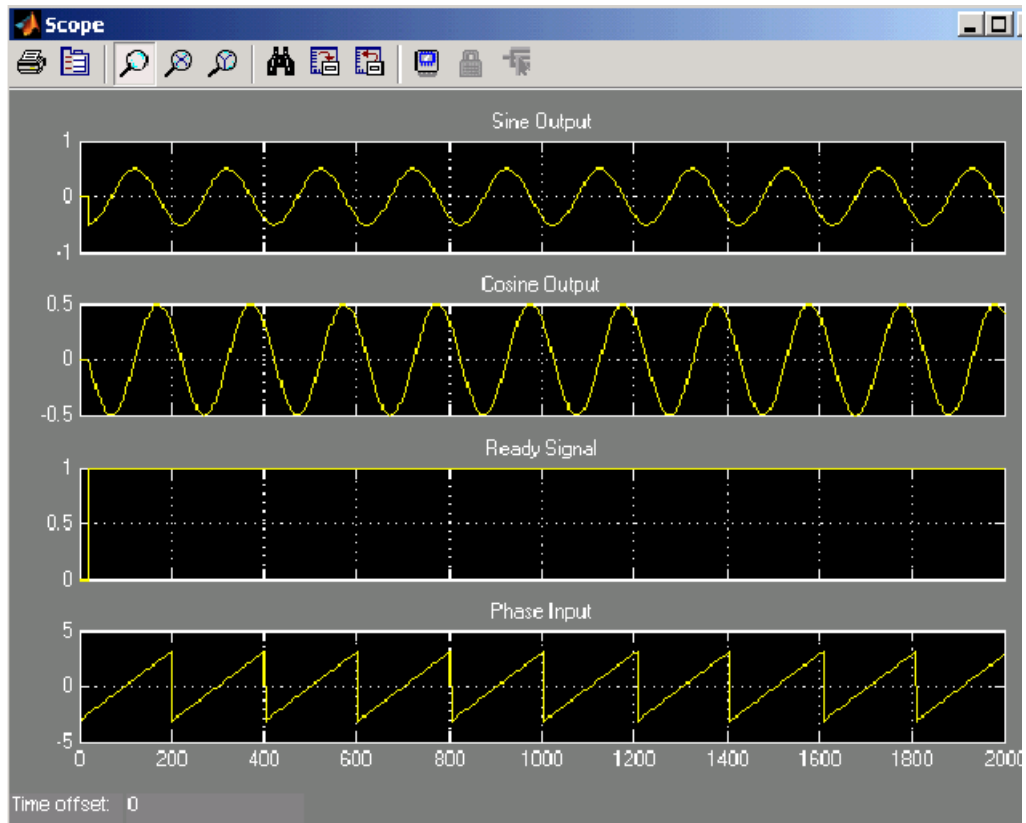

## Black Box Tutorial Example 2: Importing a Core Generator Module that Needs a VHDL Wrapper to Satisfy Black Box HDL Requirements

1. Start Core Generator and open the following Core Generator project file:  
`<ISE_Design_Suite_tree>/sysgen/examples/coregen_import/example2/coregen_import_example2.cgp`
2. As shown below, double click the **FIR Compiler** icon to launch the customization GUI.

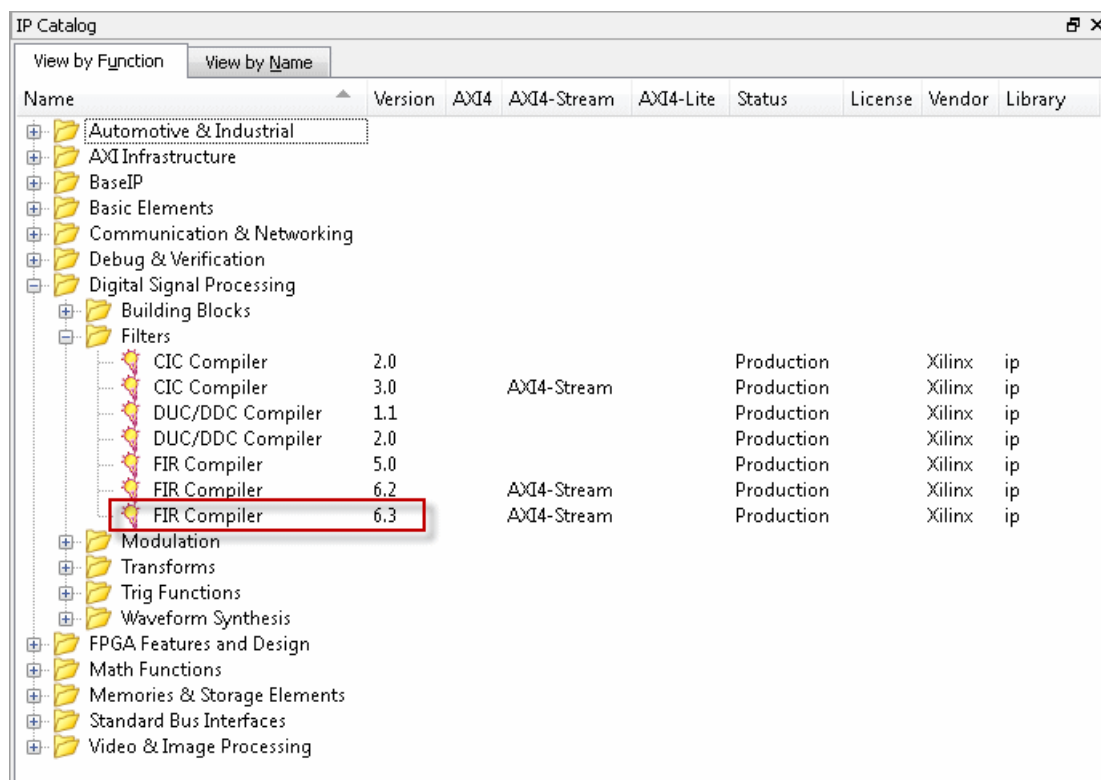

3. Customize and generate the FIR Compiler 4.0 core with the following parameters:
  - ◆ Component Name: **fir\_compiler\_8tap**
  - ◆ Filter Coefficients:
    - Select Source: COE File
    - Coefficient File: Browse and load Coefficients: **fir\_compiler\_8tap.coe** file located in the System Generator directory.



The screenshot shows the FIR Compiler GUI with the following settings:

- Component Name: fir\_compiler\_8tap
- Filter Coefficients:
  - Select Source: COE File
  - Coefficient Vector: 6,0,-4,-3,5,6,-6,-13,7,44,64,44,7,-13,-6,6,5,-3,-4,0,6
  - Coefficients File: .\fir\_compiler\_8tap.coe
  - Number of Coefficient Sets: 1 (Range: 1..256)
  - Number of Coefficients (per set): 8
  - Use Reloadable Coefficients:
- Filter Specification:
  - Filter Type: Single Rate
  - Inferred Coefficient Structure(s): Symmetric or Non Symmetric
  - Rate Change Type: Integer
  - Interpolation Rate Value: 1 (Range: 1..1)
  - Decimation Rate Value: 1 (Range: 1..1)
  - Zero Pack Factor: 1 (Range: 1..1)

Navigation buttons at the bottom: Datasheet, < Back, Page 1 of 6, Next >, Generate, Cancel, Help.

- ◆ Click **Next >**
- ◆ Hardware Oversampling Specification
  - Input Sampling Frequency: **25**
  - Clock Frequency: **300**
- ◆ Leave the other parameters set to the default values

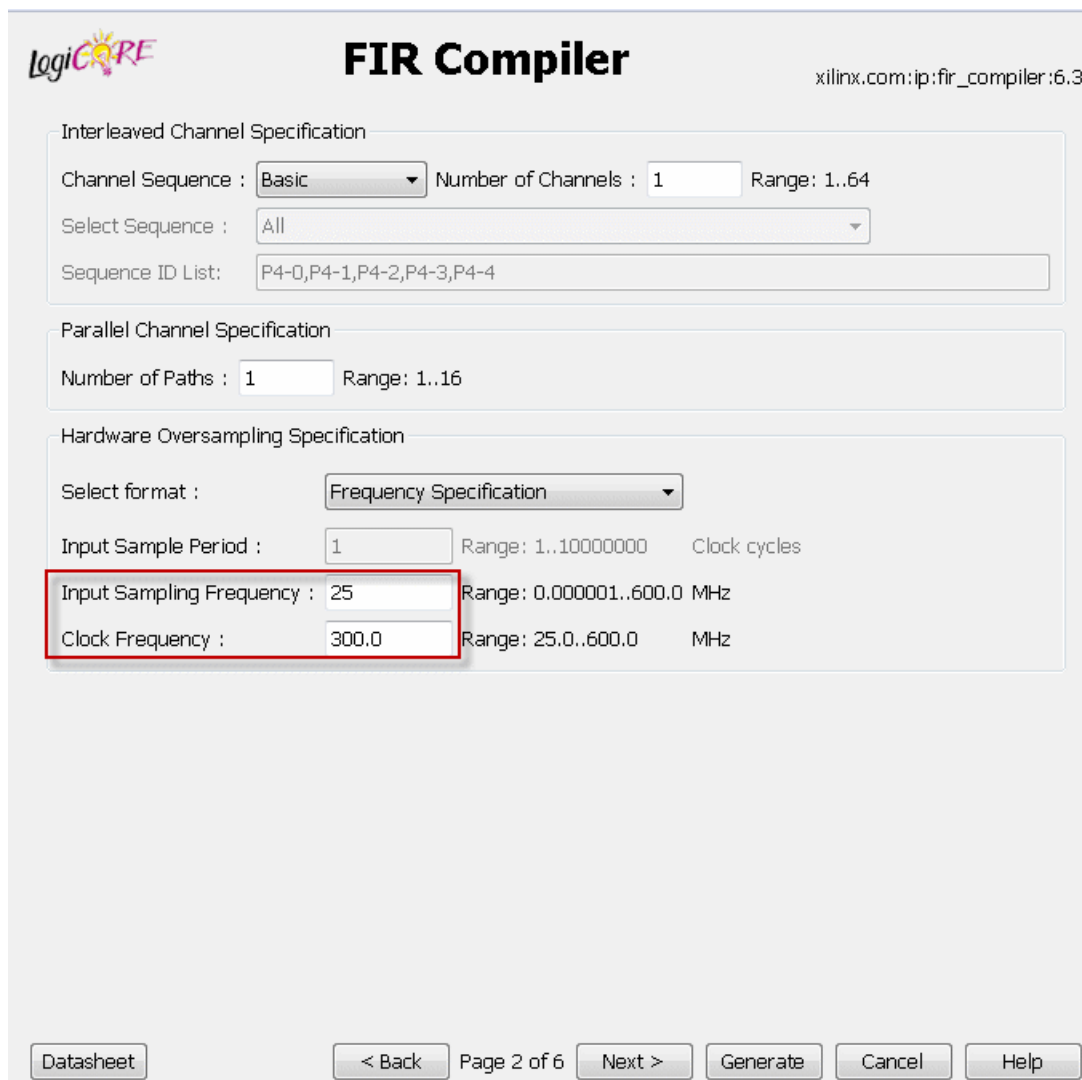

**LogiCORE** **FIR Compiler** xilinx.com:ip:fir\_compiler:6.3

**Interleaved Channel Specification**

Channel Sequence :  Number of Channels :  Range: 1..64

Select Sequence :

Sequence ID List:

**Parallel Channel Specification**

Number of Paths :  Range: 1..16

**Hardware Oversampling Specification**

Select format :

Input Sample Period :  Range: 1..10000000 Clock cycles

Input Sampling Frequency :  Range: 0.000001..600.0 MHz

Range: 25.0..600.0 MHz

Page 2 of 6

- ◆ In the next two frames, leave the options set to the default values.
4. This example will show you how to import a core that does not have a CE (clock enable) port. In the next frame, Verify that the CE or ACLKEN port option in the Control Signals field is not selected, then click **Generate**.

CORE Generator produces the following files:

**fir\_compiler\_8tap.ngc**: Implementation netlist

**fir\_compiler\_8tap.vhd**: VHDL wrapper for behavioral simulation

**fir\_compiler\_8tap.vho**: Core instantiation template

**fir\_compiler\_8tap.xco**: Parameters selected for core generation

Multiple **.mif** files: Memory initialization files for functional simulation

Since this core does not have a `ce` port and the System Generator blackbox requires a `c1k`, `ce` pair, you need to specify a core wrapper to add a `ce` port to the top level.

5. Open the following empty template wrapper file:  
`<ISE_Design_Suite_tree>/sysgen/examples/coregen_import/example2  
/ fir_compiler_8tap_wrapper.vhd`

This file contains an empty entity declaration.

6. Modify the template wrapper according to the instructions below:
  - ◆ Open the `fir_compiler_8tap.vho` file.
  - ◆ Copy the component declaration from `fir_compiler_8tap.vho` and paste it in `fir_compiler_8tap_wrapper.vhd` in the component declaration area.  
(after `-- Add Component Declaration from VHO file -----`)
  - ◆ Copy the core instantiation template from `fir_compiler_8tap.vho` and paste it in `fir_compiler_8tap_wrapper.vhd` in the architecture body.  
(after `----- ADD INSTANTIATION Template -----`)
  - ◆ Copy the port declaration for the component `fir_compiler_8tap` and paste it for the `fir_compiler_8tap` entity declaration  
(after `---- Add Port declaration for entity ----`)

- ◆ Add the `ce` port to the top-level entity declaration, and change the case of the `CLK` port to `clk`.

```

LIBRARY std, ieee;
USE std.standard.ALL;
USE ieee.std_logic_1164.ALL;
-- Remember to modify the CLK port declaration
-- of the entity below to be lower case
entity fir_compiler_8tap_wrapper is
---- Add Port declaration for entity ----
  PORT (
    clk: IN STD_LOGIC;
    ce: IN STD_LOGIC;
    s_axis_data_tvalid : IN STD_LOGIC;
    s_axis_data_tready : OUT STD_LOGIC;
    s_axis_data_tdata : IN STD_LOGIC_VECTOR(15 DOWNTO 0);
    m_axis_data_tvalid : OUT STD_LOGIC;
    m_axis_data_tdata : OUT STD_LOGIC_VECTOR(31 DOWNTO 0));
---- End Port declaration for entity ----
end fir_compiler_8tap_wrapper;

architecture test of fir_compiler_8tap_wrapper is

-- Add Component Declaration from VHO file ----
COMPONENT fir_compiler_8tap
  PORT (
    aclk : IN STD_LOGIC;
    s_axis_data_tvalid : IN STD_LOGIC;
    s_axis_data_tready : OUT STD_LOGIC;
    s_axis_data_tdata : IN STD_LOGIC_VECTOR(15 DOWNTO 0);
    m_axis_data_tvalid : OUT STD_LOGIC;
    m_axis_data_tdata : OUT STD_LOGIC_VECTOR(31 DOWNTO 0)
  );
END COMPONENT;
---- End COMPONENT Declaration ----
begin
---- ADD INSTANTIATION Template ----
U0 : fir_compiler_8tap
  PORT MAP (
    aclk => clk,
    s_axis_data_tvalid => s_axis_data_tvalid,
    s_axis_data_tready => s_axis_data_tready,
    s_axis_data_tdata => s_axis_data_tdata,
    m_axis_data_tvalid => m_axis_data_tvalid,
    m_axis_data_tdata => m_axis_data_tdata
  );
---- End INSTANTIATION Template ----
end test;

```

7. Start Simulink and open the following design file:  
 <ISE\_Design\_Suite\_tree>/sysgen/examples/coregen\_import/example2  
 /coregen\_import\_example2.mdl

- Drag and drop the black box from the "Basic Elements" library in the coregen\_import\_example2.mdl. Select fir\_compiler\_8tap\_wrapper.vhd for the top-level HDL file.

Example showing how to import an IP with no ce port from CoreGen

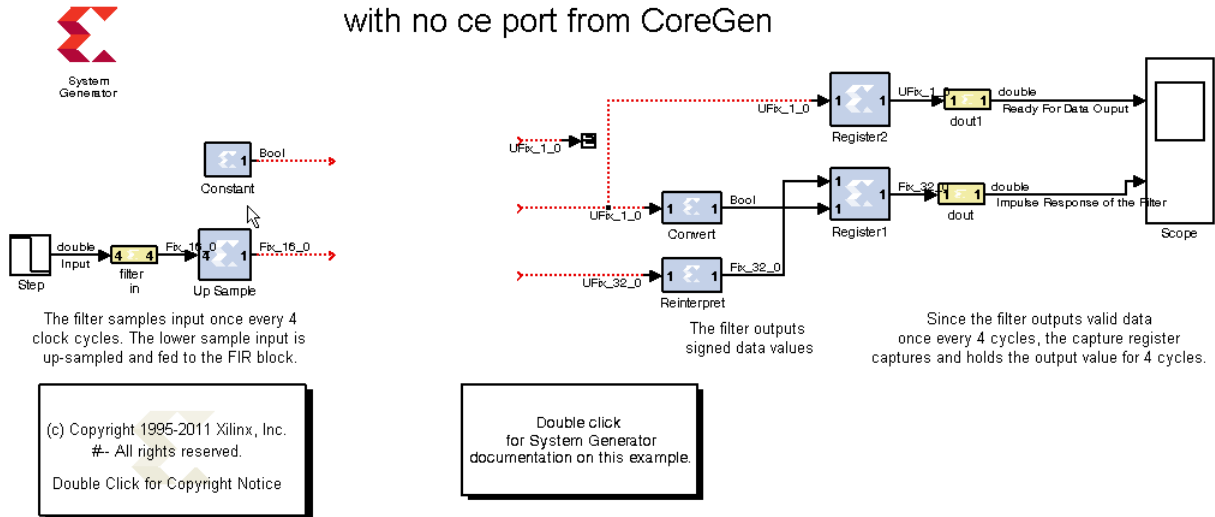

- Connect the black box to the open wires.
- Open the fir\_compiler\_8tap\_wrapper\_config.m file, and add the VHDL file, EDIF netlist and MIF files to the black box file list as shown below. These files get included as part of the System Generator netlist for the design when it is generated.

```
this_block.addFile('fir_compiler_8tap_wrapper.vhd');
this_block.addFile('fir_compiler_8tap.vhd');
this_block.addFile('fir_compiler_8tap.mif');
this_block.addFile('fir_compiler_8tap.ngc');
```

**Note:** The order in which the files are added in the configuration function is the order in which they get compiled during synthesis and simulation.

- Open the black box parameterization GUI and select the **ISE Simulator** for simulation mode.

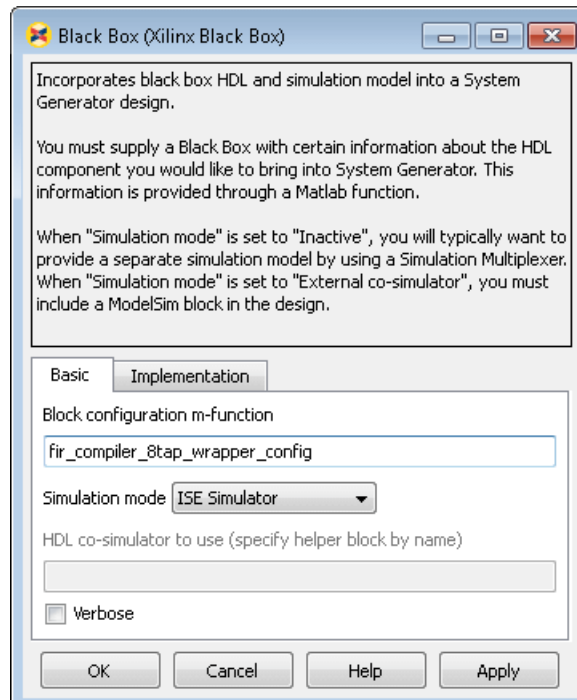

- Press the **Simulate** button to compile and co-simulate the FIR core using the ISE simulator. The simulation results are as shown below.

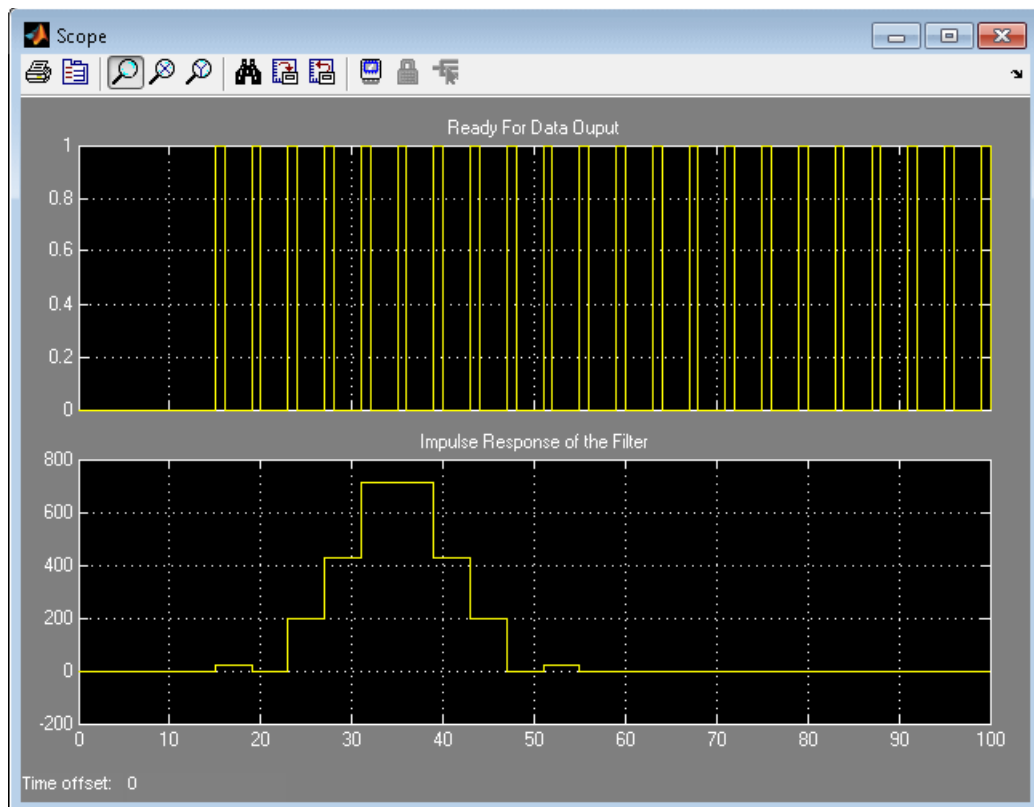

## Importing a VHDL Module

### Black Box Tutorial Example 3: Importing a VHDL Module

This topic explains how to use the black box to import VHDL into a System Generator design and how to use ModelSim to co-simulate the VHDL module.

1. From the MATLAB console, change the directory to  
<ISE\_Design\_Suite\_tree>/sysgen/examples/black\_box/intro.  
The following files are located in this directory:
  - ◆ black\_box\_intro.mdl - A Simulink model containing an example black box.
  - ◆ transpose\_fir.vhd - Top-level VHDL for a transpose form FIR filter. This file is the VHDL that is associated with the black box.
  - ◆ mac.vhd - Multiply and add component used to build the transpose FIR filter.
2. Open the black\_box\_intro model from the MATLAB command window by typing  

```
>> black_box_intro
```
3. Open the subsystem named **Transpose FIR Filter Black Box**. At this point, the subsystem contains two inports and one output. The black box subsystem is shown below:

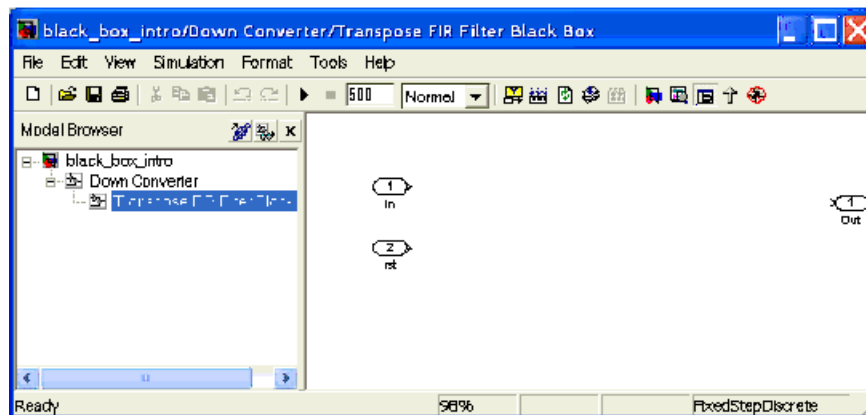

4. Go to the Simulink Library Browser and add a black box block to this subsystem. The black box is located in the Xilinx Blockset's Basic Elements library. The Black Box Configuration Wizard is automatically invoked when a new black box is added to the subsystem. A browser window appears that lists the VHDL source files that can be

associated with the black box. From this window, select the top-level VHDL file `transpose_fir.vhd`. This is illustrated in the figure below:

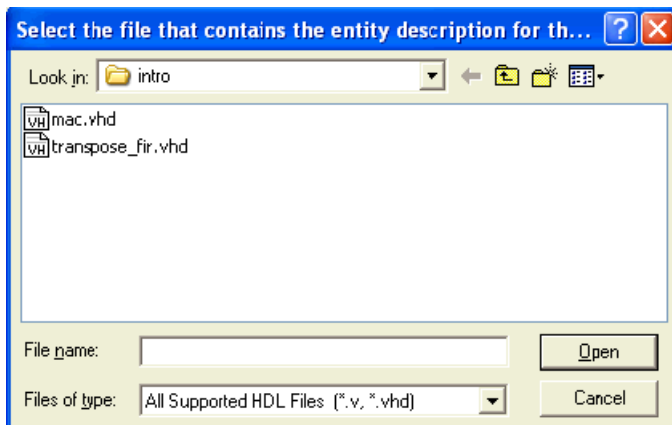

**Note:** The wizard will only run if the black box is added to a model that has been saved to a file. If the model has not been saved, the wizard does not know where to search for files and System Generator will instead display a warning that looks like the following:

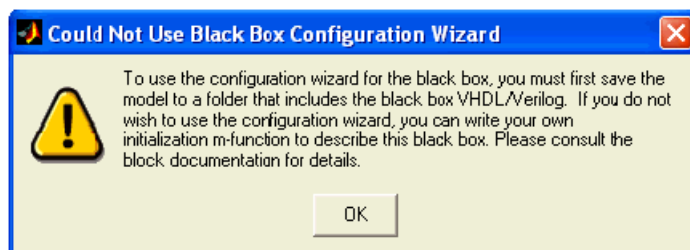

- The wizard parses the VHDL to generate a configuration M-function for the black box. This is a MATLAB script that, among other things, associates the black box to the VHDL and creates black box ports. Once the function has run, the ports on the black box match those in the top-level VHDL entity (not including clock and clock enable ports). This is illustrated below:

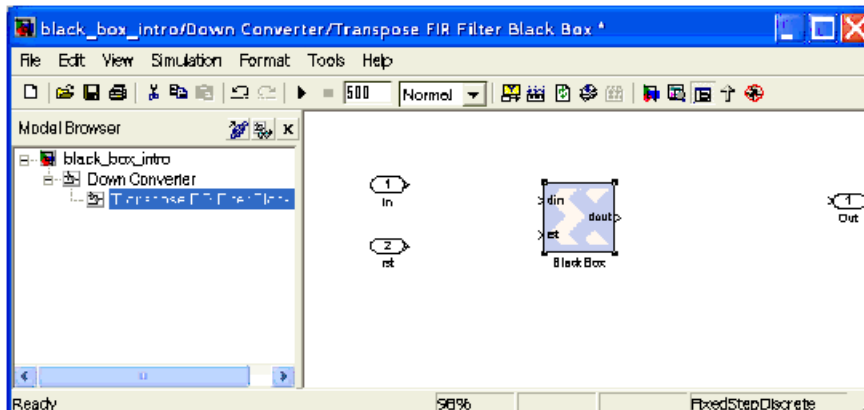



Be aware of the following rules when working this example:

- ◆ A synchronous HDL design that is associated with a black box must have one or more clock and clock enable ports. These ports must occur in pairs, one clock for each clock enable, and vice-versa. Each of these ports must be of type `std_logic`. The name of the clock port must contain the substring `clk`. The name of the clock enable port must be the same as the name of the clock port, but with `ce` substituted for `clk`.
  - ◆ The clock enable port has a specific meaning to System Generator and is not a general purpose user enable for the block. Refer to the topic [Black Box HDL Requirements and Restrictions](#) for details.
6. Double click on the black box block. The dialog box shown below appears:

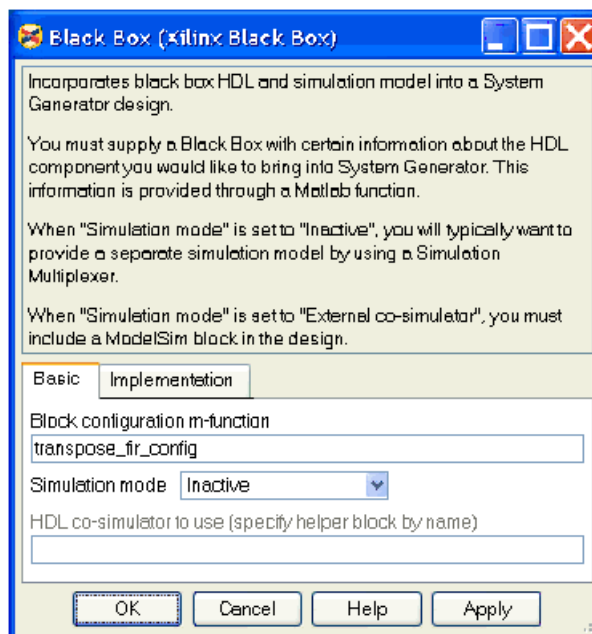

The following are the fields in the dialog box:

- ◆ **Block configuration M-function** - This specifies the name of the configuration M-function for the black box. In this example, the field contains the name of the function that was generated by the Configuration Wizard. By default, the black box uses the function the wizard produces. You can, however, substitute one you produce yourself. For more information on the configuration M-function, refer to the topic [Black Box Configuration M-Function](#).
- ◆ **Simulation mode** - There are three simulation modes:
  - **Inactive** - When the mode is Inactive, the black box participates in the simulation by ignoring its inputs and producing zeros. This setting is typically used when a separate simulation model is available for the black box, and the model is wired in parallel with the black box using a simulation multiplexer. [Black Box Tutorial Example 1: Importing a Core Generator Module that Satisfies Black Box HDL Requirements](#) shows how this is accomplished.
  - **ISE Simulator** - When the mode is **ISE Simulator**, simulation results for the black box are produced using co-simulation on the HDL associated to the black box.

- **External co-simulator** - When the mode is **External co-simulator**, it is necessary to add a ModelSim HDL co-simulation block to the design, and to specify the name of the ModelSim block in the field labeled **HDL co-simulator to use**. In this mode, the black box is simulated using HDL co-simulation.
  - ◆ **FPGA Area Estimation** - The numbers entered in this field are estimates of how much of the FPGA is used by the HDL for the black box. These numbers must be entered by hand. The numbers are only needed if you would like to use the resource estimating utilities supplied with System Generator. For more information, see [Resource Estimation](#).
- To continue the tutorial, leave the parameters set as they currently are.
7. Wire the black box's ports to the corresponding subsystem ports.
  8. Run the simulation by clicking the Simulation **Play** button and then double click on the scope block. Notice the black box output shown in the Output Signal scope is zero. This is expected as the black box is configured to be inactive during simulation.

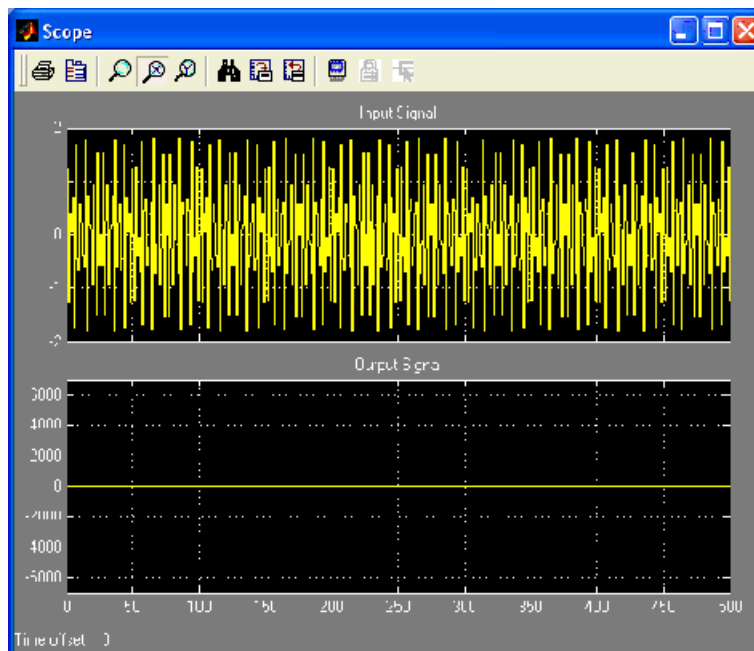

- Go to the Simulink Library Browser and add a ModelSim block to this subsystem. The ModelSim block is located in the **Xilinx Blockset /Tools** library. This block enables the black box to communicate with a ModelSim simulator. Double click on the ModelSim block to open the dialog box shown below:

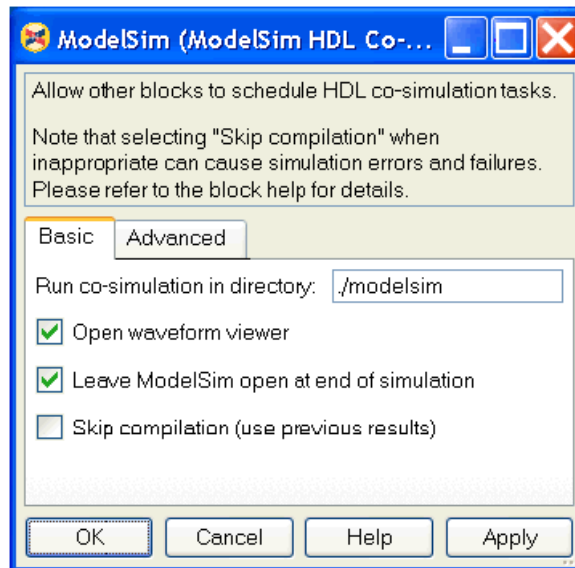

- Make sure the parameters match those shown in the preceding figure. Close the dialog box.
- From the Simulink menu, select **Port Data Types** from the **Format** menu to display the port types for the black box. Compile the model (Ctrl-d) to ensure the port data types are up to date. Notice that the black box port output type is `UFix_26_0`. This means it is unsigned, 26 bits wide and has a binary point 0 positions to the left of the least significant bit.
- Open the configuration M-function `transpose_fir_config.m` and change the output type from `UFix_26_0` to `Fix_26_12`. The modified line should read:
- Edit the configuration M-function to associate an additional HDL file with the black box. Locate the line:

```
this_block.addFile('transpose_fir.vhd');
```

Immediately above this line, add the following:

```
this_block.addFile('mac.vhd');
```

14. Save the changes to the configuration M-function and recompile the model (Ctrl-d). Your subsystem should appear as follows:

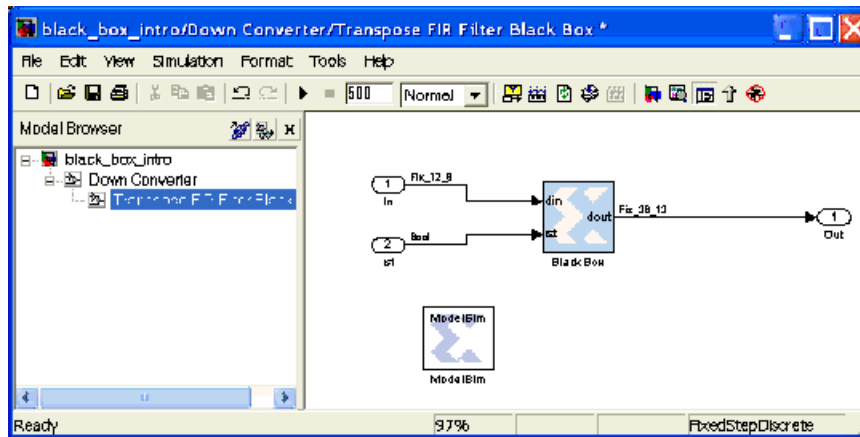

15. From the black box block parameter dialog box, change the Simulation mode field from **Inactive** to **External co-simulator**. Enter ModelSim in the **HDL co-simulator to use** field. The name in this field corresponds to the name of the ModelSim block that you added to the model. The black box dialog box should appear as follows:

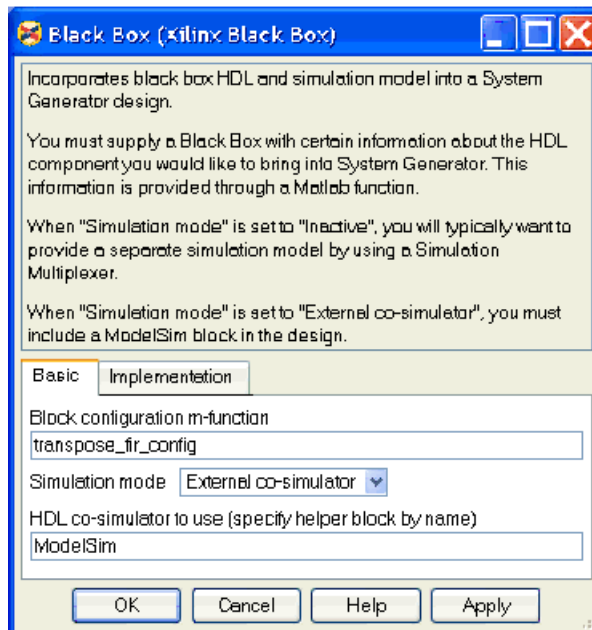

- Run the simulation. A ModelSim command window and waveform viewer opens. ModelSim simulates the VHDL while Simulink controls the overall simulation. The resulting waveform looks something like the following:

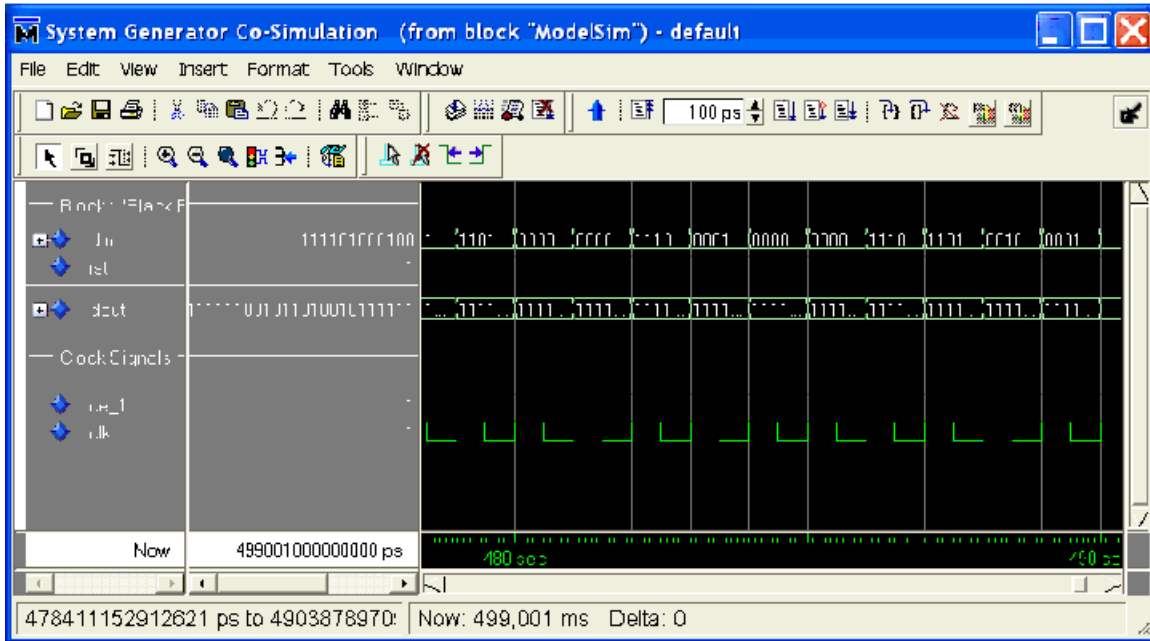

The following warnings received in ModelSim can safely be ignored.

```
# ** Warning: There is an 'U'|'X'|'W'|'Z'|'-' in an arithmetic operand,
the result will be 'X'(es).
# Time: 0 ps Iteration: 0 Instance: /
xlcossim_black_box_ex1_down_converter_transpose_fir_filter_b1
ack_box_modelsim/
black_box_ex1_down_converter_transpose_fir_filter_black_box_
black_box/g0__22/g_last/m2
```

They are caused by the black box VHDL not specifying initial values at the start of simulation.

17. Examine the scope output after the simulation has completed. When the Simulation Mode was set to **Inactive**, the Output Signal scope displayed constant zero. Notice the waveform is no longer zero. Instead, Output Signal shows the results from the ModelSim simulation.

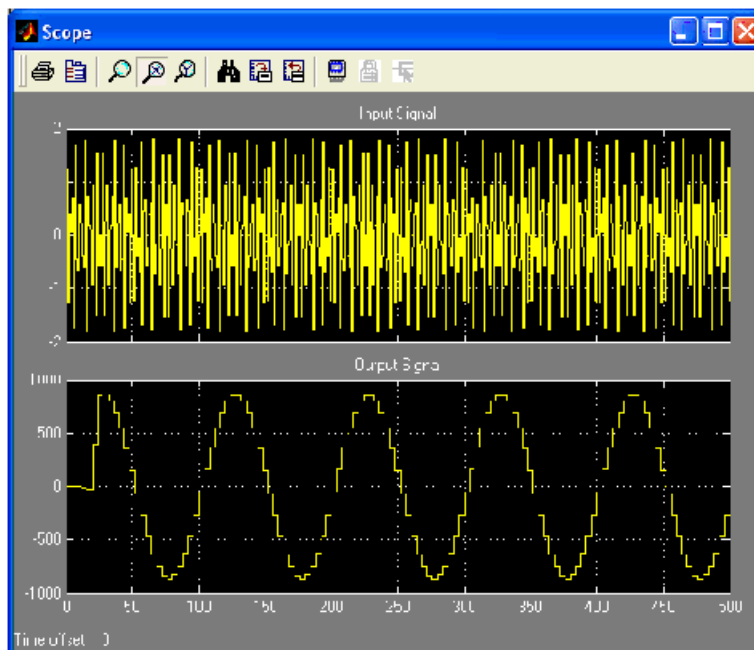

## Importing a Verilog Module

This example demonstrates how Verilog black boxes can be used in System Generator and co-simulated using ModelSim. Verilog modules are imported the same way VHDL modules are imported. For more information on how this is done, see the topics [Black Box Configuration Wizard](#) and [Black Box Configuration M-Function](#). System Generator provides all of the code that is needed to incorporate Verilog black boxes, both to generate hardware and to co-simulate HDL. System Generator also allows Verilog black boxes to be parameterized. This example demonstrates all of these capabilities. The files for this example are contained in the following directory:

```
<ISE_Design_Suite_tree>/sysgen/examples/black_box/example4.
```

The files are:

- `black_box_ex4.mdl` – A Simulink model with two black boxes, one using VHDL and the other using Verilog.
- `word_parity_block.vhd` – The VHDL for the combinational portion of the state machine seen in word parity example presented above. This is a purely combinational (stateless) block that computes the parity of each input word and outputs the parity bit. It has been parameterized with a generic so that it can accept any input type (see the description of dynamic black boxes for a discussion of generics).
- `word_parity_block_config.m` – The configuration M-function for the VHDL black box, including the generic setting. The M-function tags this block as combinational so that it simulates correctly in Simulink.
- `shutter.v` – The Verilog for a simple synchronous latch. The code has been parameterized so that the input port `din` can have arbitrary width.

- shutter\_config.m – The configuration M-function for the Verilog black box, including the parameter setting. The configuration M-function uses methods referring to VHDL syntax even for configuring Verilog black boxes. Thus for this black box, you have the lines:

```
this_block.setEntityName('shutter');
this_block.addGeneric('din_width', dwidth);
```

### Black Box Tutorial Example 4: Importing a Verilog Module

1. Navigate into the example4 directory and open the example model.

This is a simple design with two black boxes, one VHDL and the other Verilog. The VHDL black box computes the parity of each input word, and the Verilog black box latches the words that have odd parity. No Simulink model is used to compute the behavior of the black boxes; instead, HDL co-simulation is used. The example model is shown in the figure below.

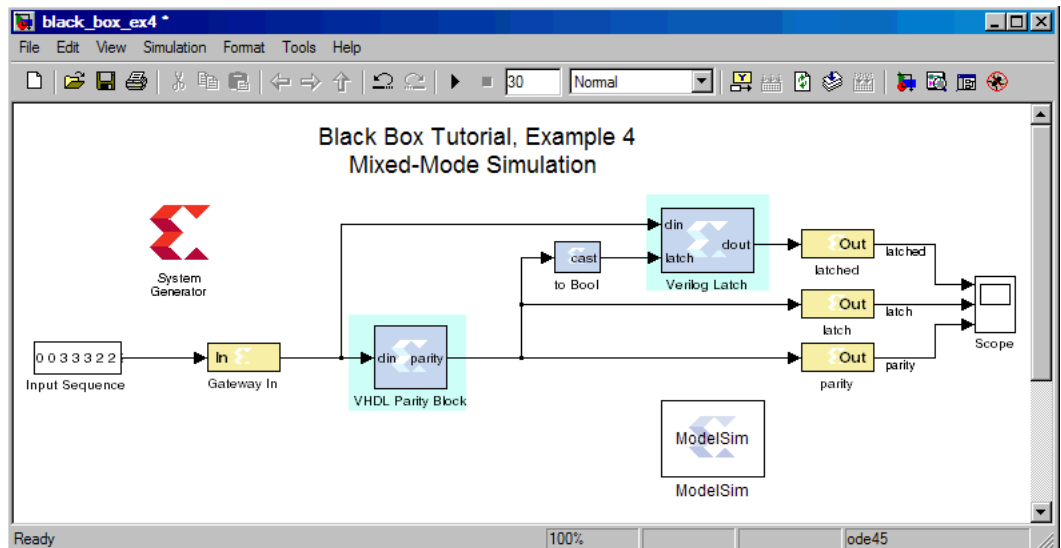

You must have a license for mixed-mode ModelSim simulation to run this example. If you do and you run the simulation, you will see a ModelSim waveform window that looks like the one captured below. The behavior of both black boxes is shown. You can browse the design structure in ModelSim to see how System Generator has combined the two black boxes.

2. Change the input type to an arbitrary type and rerun the simulation. Both black boxes adjust in the appropriate way to the change.

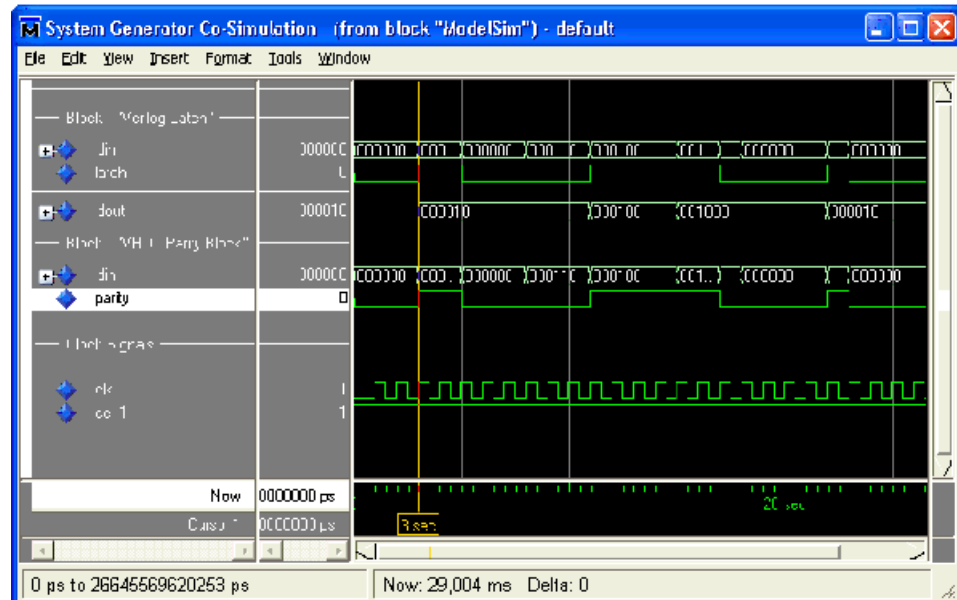

## Dynamic Black Boxes

This example extends the transpose FIR filter black box so that it is dynamic, i.e., able to adjust to changes in the widths of its inputs. The example is contained in the directory `<ISE_Design_Suite_tree>/sysgen/examples/black_box/example3`. For this example to run correctly, you must change your directory (`cd` within the MATLAB command window) to this directory before launching the example model.

The files contained in this directory are:

- `black_box_ex3.mdl` - A Simulink model containing a dynamic black box.
- `transpose_fir_parametric.vhd` - The VHDL for the transpose FIR filter.
- `mac.vhd` - Multiply and add component used to build the transpose FIR filter.
- `transpose_fir_parametric_config.m` - The configuration M-function for the black box.

### Black Box Tutorial Example 5: Dynamic Black Boxes

1. Open the model by typing `black_box_ex3` at the **MATLAB** command prompt.
2. Run the simulation from the top-level model, and view the results displayed in the scopes.



- Reduce the number of bits on the gateway **Din Gateway In** from 16 bits down to 12 and the binary point from 14 to 10, then run the simulation again. Note that both the input and output widths on the black box adjust automatically. The black box subsystem and simulation results should look like those shown below.

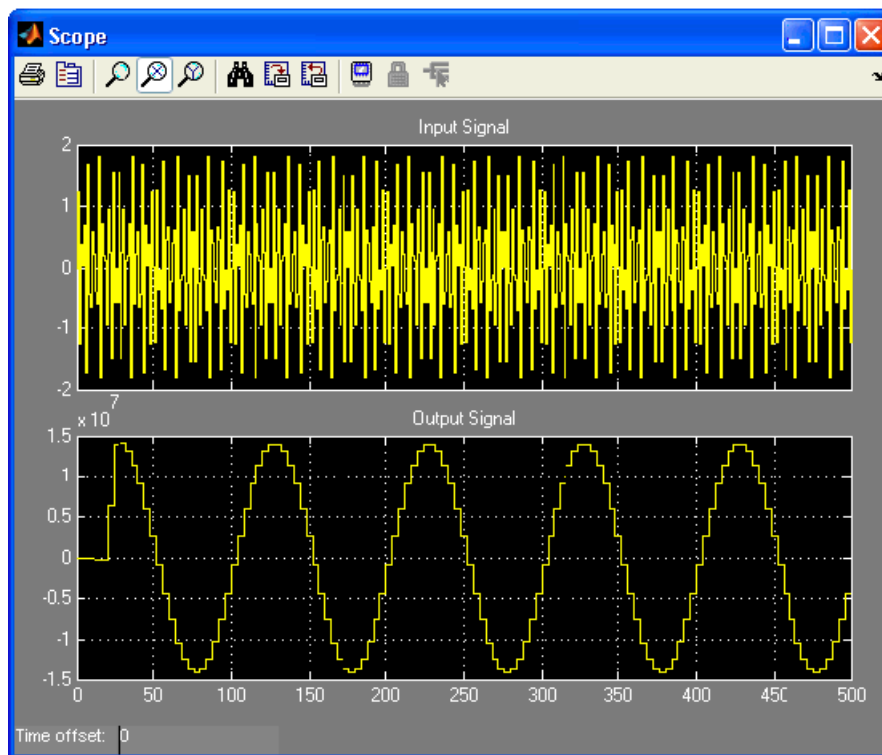
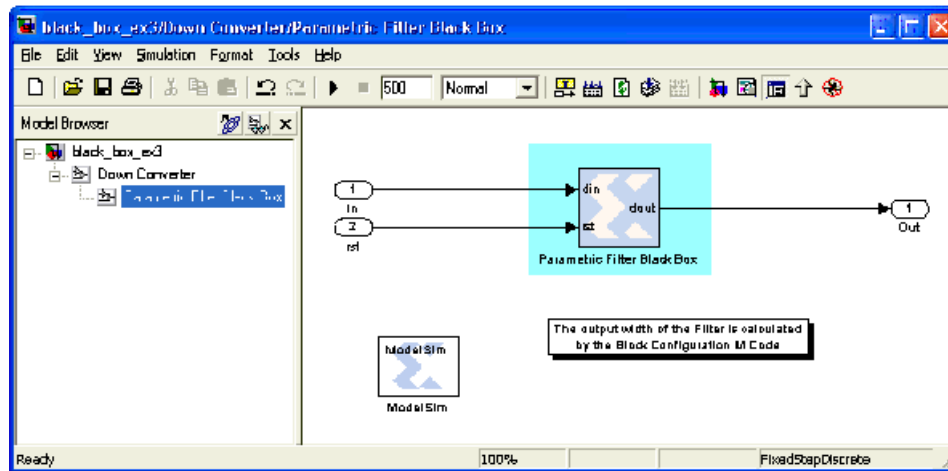

4. The black box is able to adjust to changes in input width because of its configuration M-function. To make this work, the M-function must be augmented by hand. Open the M-function file `transpose_fir_parametric.m`. The important points are described below.

- Obtaining data input width:

```
input_bitwidth = this_block.port('din').width;
```

- Calculating output width:

```
output_bitwidth = ceil(log2(2^(input_bitwidth-1)*2^(coef_bitwidth-1) *
number_of_coef));
```

- Setting output data type:

```
dout_port.makeSigned;
dout_port.width = output_bitwidth;
dout_port.binspt = 12;
```

- Passing input and output bit widths to VHDL as generics:

```
this_block.addGeneric('input_bitwidth',this_block.port('din').width);
this_block.addGeneric('output_bitwidth',output_bitwidth);
```

For details concerning the black box configuration M-function, see the topic [Black Box Configuration M-Function](#).

If you examine the black box VHDL file `transpose_fir_parametric.vhd` you see generics `input_bitwidth` and `output_bitwidth` that specify input and output width. These are passed to lower-level VHDL components.

## Simulating Several Black Boxes Simultaneously

Several System Generator black boxes can co-simulate simultaneously, using only one ModelSim license while doing so. The example shown below illustrates this. The files for the example are contained in the directory

```
<ISE_Design_Suite_tree>/sysgen/examples/black_box/example2.
```

The files contained in this directory are:

- `black_box_ex2.mdl`: A Simulink model containing two black boxes.
- `parity_block.vhd`: VHDL for a simple state machine that tracks the running parity of an 8-bit input word.
- `parity_block_config.m`: The configuration M-function for the black boxes. The code has barely been changed from what was produced by the Configuration Wizard: the line that tagged the block as having a combinational feed-through path (`this_block.tagAsCombinational`) has been removed.

### Black Box Tutorial Example 6: Simulating Several Black Boxes Simultaneously

Navigate into the `example2` directory and open the example model. This is a simple model with two identical black boxes, each implementing a state machine. The state machines compute the running parity of their inputs. One black box is fed the input stream of the model and the other is fed the input stream after it has been serialized and de-serialized. Notice that no simulation model is provided for either state machine. Instead, HDL co-simulation is used to produce simulation results. The ModelSim block provides

the connection between the black boxes and ModelSim. The example model is shown in the figure below.

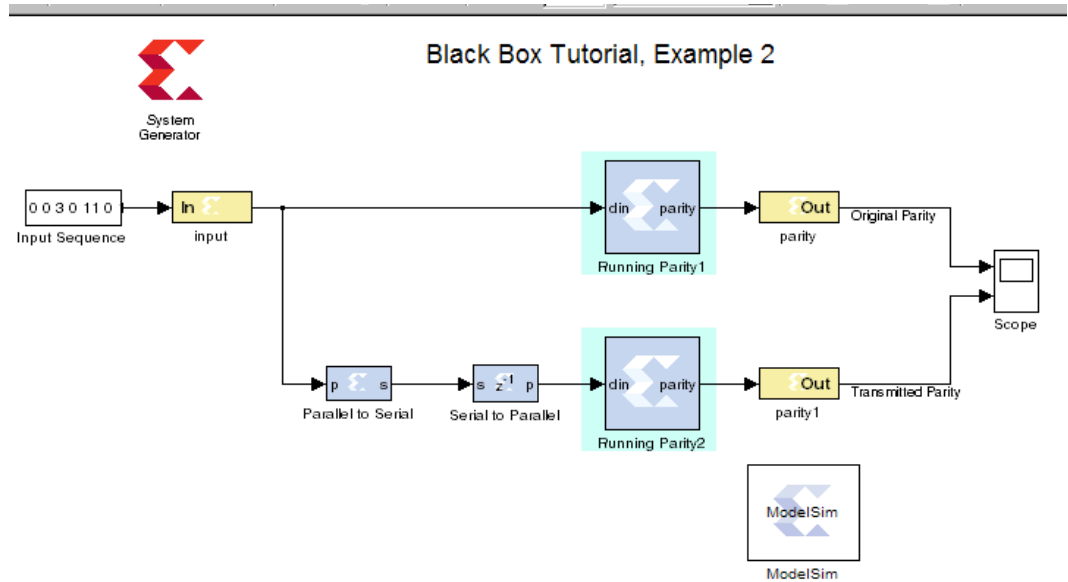

If you run the simulation, you will see a Simulink scope and ModelSim waveform window that look like the figures below. The scope shows that the black boxes produce matching parity results (as expected), but with one delayed from the other by one clock cycle. The waveform window shows the same results, but viewed in ModelSim and expressed in binary. System Generator automatically configures the waveform viewer to display the input and output signals of each black box. You can also browse the design structure in ModelSim to see how System Generator has elaborated the design to combine the two black boxes.

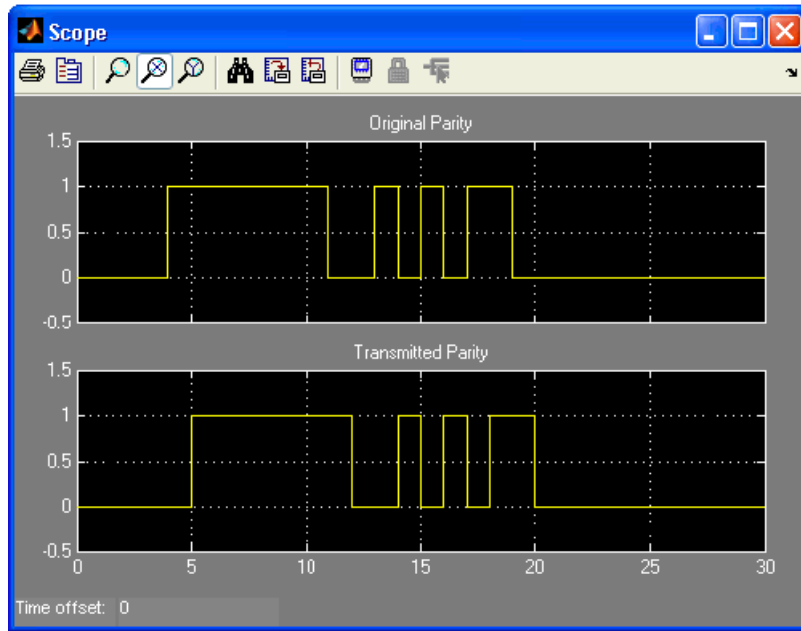

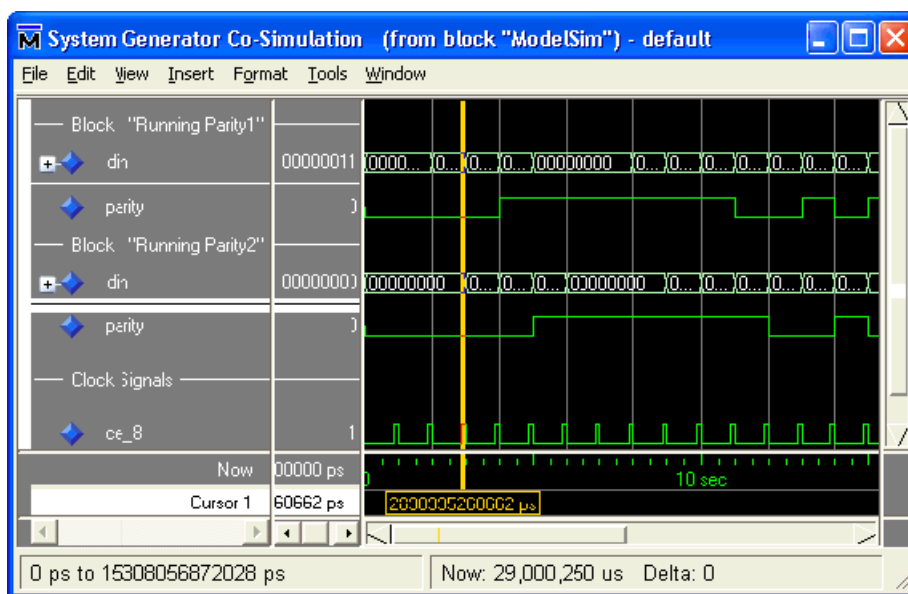

## Advanced Black Box Example Using ModelSim

The following topics are discussed in this example:

- How to design a black box with a dynamic port interface;
- How to configure a black box using mask parameters;
- How to assign generic values based on input port data types;
- Saving black box blocks in Simulink libraries for later reuse;
- How to specify custom scripts for ModelSim HDL co-simulation.

This example also shows a way to view signals coming from a black box. In Simulink, waveforms are typically viewed with a scope. The Simulink scope block serves this purpose and the System Generator WaveScope block is available in versions 8.1 and later. The waveform viewer in the ModelSim simulator may also be used to view waveforms. In this example, a black box is configured as a specialized ModelSim waveform scope for Xilinx fixed-point signals. When a model that uses the black box scope is simulated, the signals that drive the black box are displayed in ModelSim.

The files for this example are contained in the directory

<ISE\_Design\_Suite\_tree>/sysgen/examples/black\_box/example5.

The files contained in this directory are:

- `black_box_ex5.mdl`: A Simulink model containing a black box scope.
- `scope_lib.mdl`: A Simulink library containing the black box waveform viewer.
- `scope_config.m`: The configuration M-function for the black box waveform viewer.
- `scope1.vhd`, `scope2.vhd`, `scope3.vhd`, `scope4.vhd`: Black box VHDL for the signal scope that accept one, two three, and four input signals, respectively.
- `waveform.do` – A script that instructs ModelSim how to display signals during simulation.

## Black Box Tutorial Exercise 7: Advanced Black Box Example Using ModelSim

1. Navigate into the example5 directory and open the example `black_box_ex5.mdl` file. The model includes an adder that is driven by two input gateways. The gateways are configured to produce signed 8-bit values, each with six bits to the right of the binary point. Sine wave generators drive the gateways. The model also includes a black box named waveform scope. This is driven by three signals. The first input is driven by the adder. The other two are driven by the inputs to the adder. The ModelSim block enables HDL co-simulation. The example model is shown below.

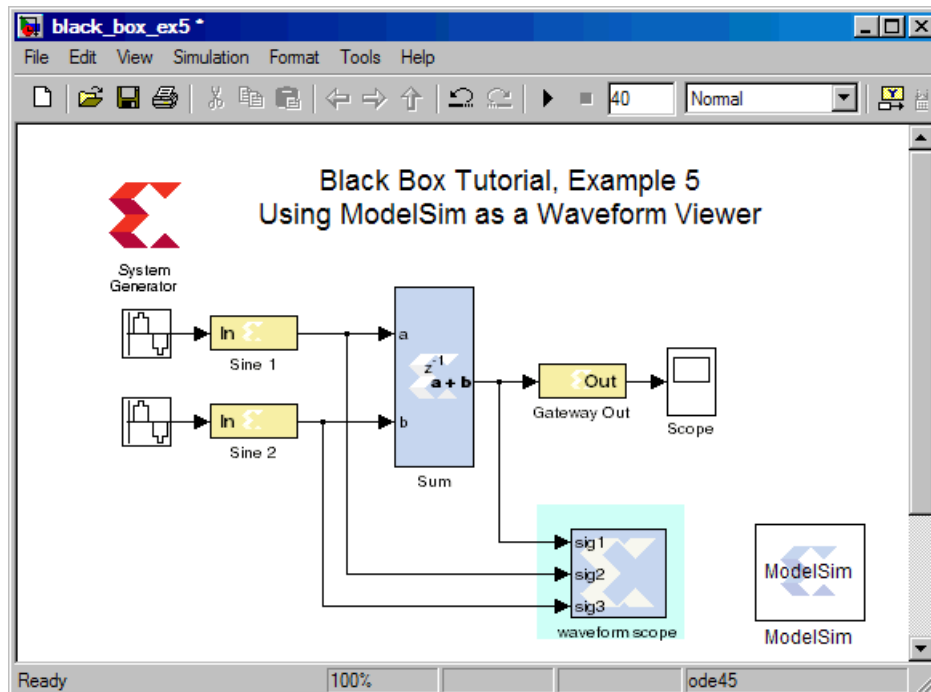

2. Simulate the `black_box_ex5` model. A ModelSim window opens and ModelSim compiles the files necessary for simulation. After the compilation is complete, both MATLAB and ModelSim simulations begin. A ModelSim waveform viewer opens and displays four signals. The first input to the block, sig1, is driven by the adder. This

signal is represented in two ways in the ModelSim viewer – binary and analog. The ModelSim waveforms for the `black_box_ex5` simulation are shown below.

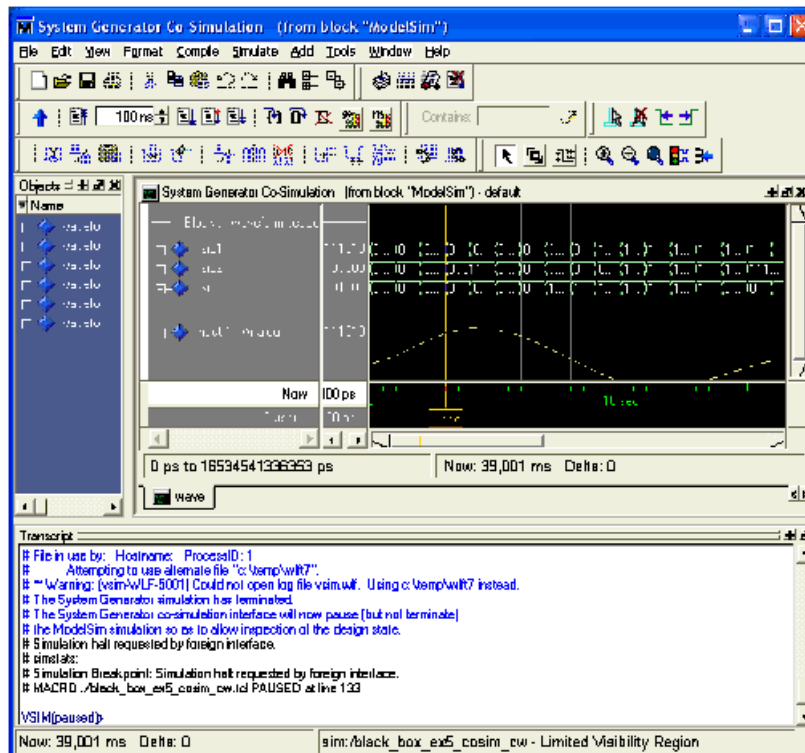

3. Double click on the Simulink scope in the model. The output is shown below and resembles the analog signal in the ModelSim waveform viewer.

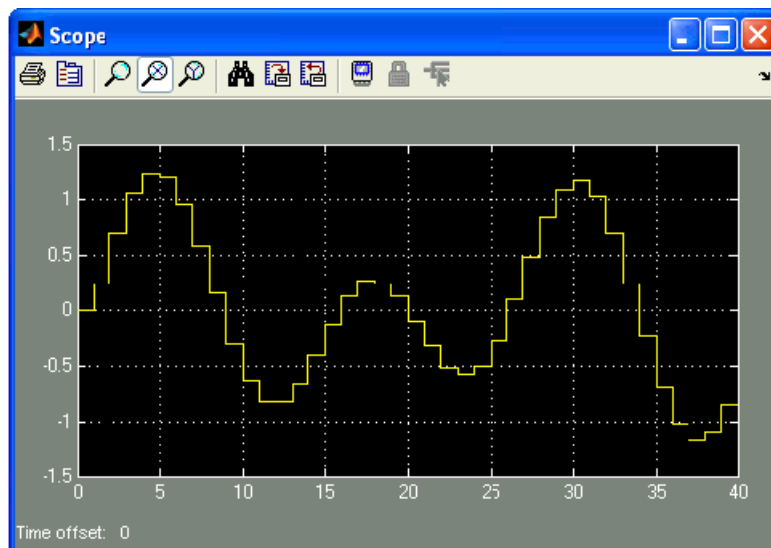

The black box in this example is configured using mask parameters. There are many situations in which this is useful. In this case, the number of black box input ports, i.e., the number of scope inputs, is determined by a mask parameter.

- Double click on the waveform scope black box. Notice a Number of Input Ports field is included in the block dialog box and is unique to this black box instance. The dialog box is shown below:

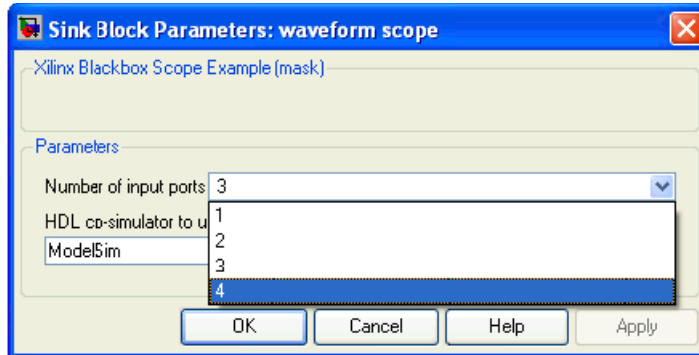

- Change the number of input ports from 3 to 4 and apply the changes. The black box now has an additional input port labeled **sig4** and should look like the following:

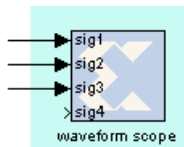

Every black box has a standard list of mask parameters. The black box in this example has an additional mask parameter `nports` that stores the number of input ports selected by the user. To change a black box mask it is necessary to disable the link to the library. When a black box is changed in this way, it is best to save the black box in a library. (See the Simulink documentation on libraries for details.) The tutorial library `scope_lib.mdl` contains the modified signal scope black box used in this example. When a black box configuration M-function adds an HDL file, the path to the file can be relative to the directory in which the library is saved. This eliminates the need to copy the HDL into the same directory as the model.

The black box's configuration M-function is invoked whenever the block parameter dialog box is modified. This allows the M-function to check the mask parameters and configure the black box accordingly. In this example, the M-function adjusts the number of block input ports based on the `nports` parameter specified in the mask.

- Open the file `scope_config.m` that defines the configuration M-function for the example black box. Locate the line:

```
simulink_block = this_block.blockName;
```

This obtains the Simulink name of the black box and assigns it to the variable `simulink_block`. The name is useful because it is the handle that MATLAB functions need to manipulate the block.

- Locate the line:

```
nports = eval(get_param(simulink_block, 'nports'));
```

The value of the `nports` mask parameter is obtained by the `get_param` command. The `get_param` returns a string containing the number of ports. An `eval` encloses the `get_param` and converts the string into an integer that is assigned to the `nports` variable.

8. Once the number of input ports is determined, the M-function adds the input ports to the black box. The code that does this is shown below.

```
for i=1:nports
    this_block.addSimulinkInport(sprintf('sig%d',i));
end
```

There are four VHDL files, named `scope1.vhd`, `scope2.vhd`, `scope3.vhd`, and `scope4.vhd`, which the black box in this example can use. The black box associates itself to the one that declares an appropriate number of ports.

9. The configuration M-function selects the appropriate VHDL file for the black box. Locate the following line in `scope_config.m`:

```
entityName = sprintf('scope%d',nports);
```

The HDL entity name for the black box is constructed by appending the value of `nports` to `scope`. The VHDL is associated with the black box in the following line:

```
this_block.addFile(['vhdl/' entityName '.vhd']);
```

10. The input port widths for each VHDL entity are assigned using generics. The generic name identifies the input port to which the width is assigned. For example, the `width3` generic specifies the width of the third input. In `scope_config.m`, the generic names and values are set as follows:

```
% -----
if (this_block.inputTypesKnown)
for i=1:nports
width = this_block.inport(i).width;
this_block.addGeneric(sprintf('width%d',i),width);
end
end % if(inputTypesKnown)
% -----
```

11. You can change the way ModelSim displays the signal waveforms during simulation by using custom tcl scripts in the ModelSim block. Double click on the ModelSim block in the `black_box_ex5` model. The following dialog box appears:

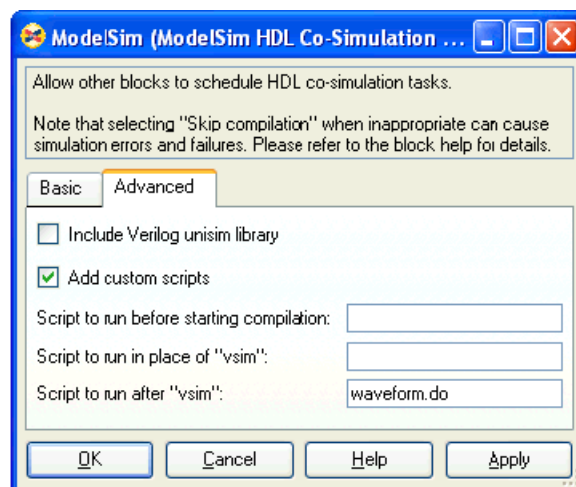

Custom scripts are defined by selecting the **Add Custom Scripts** checkbox. In this case, a script named `waveform.do` is specified in the **Script to Run** after `vsim` field. This script contains the ModelSim commands necessary to display the adder output as an analog waveform.



## Importing, Simulating, and Exporting an Encrypted VHDL File

This example show you how to import an encrypted VHDL file into a Black Box block, simulate the design, then export the VHDL out as an encrypted file that is separate from the rest of the netlist.

### Black Box Tutorial Example 8: Importing, Simulating, and Exporting an Encrypted VHDL File

- From MATLAB, open the following MDL file:  
`<ISE_Design_Suite_tree>/sysgen/examples/black_box/example7/black_box_ex7.mdl`

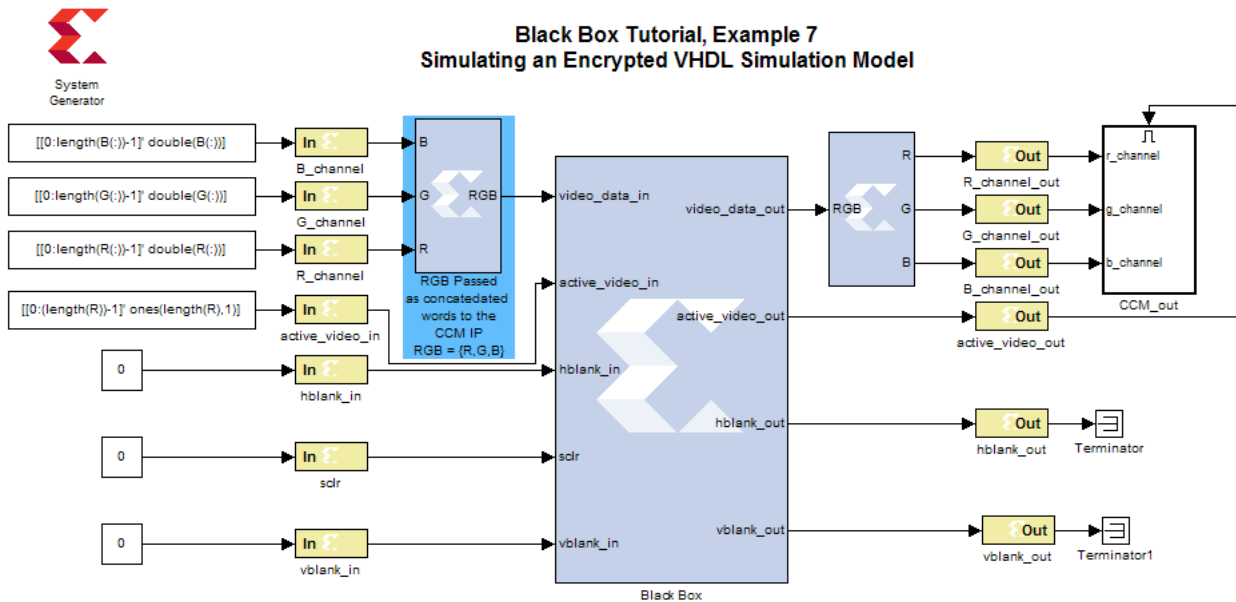

This design imports an encrypted VHDL file generated from the licensed core **Color Correction Matrix v1.0**. The input to the core is a 24-bit RGB signal {R, G, B} and the output is a Color transformed 24-bit signal {Rt, Gt, Bt} signal such that :

$$\begin{bmatrix} R_t \\ G_t \\ B_t \end{bmatrix} = \begin{bmatrix} 0.0 & 0.0 & 0.0 \\ 0.3 & 1.0 & 0.0 \\ 0.5 & 0.0 & 1.0 \end{bmatrix} \begin{bmatrix} R \\ G \\ B \end{bmatrix}$$

The **active\_video\_in** signal is used to mark each **video\_data\_in** sample as valid. The signals **hblank\_in** and **vblank\_in** are ignored in this example design. Refer to the **Color Correction Matrix v1.0** LogiCORE datasheet for more information on this core.

- The file named `encrypted_hdl_import.vhd` is the encrypted simulation model generated by Core Generator. In order to import this encrypted simulation model, you must first create a VHDL wrapper file that instantiates the encrypted VHDL model. You then import this wrapper file using the standard Black Box Configuration Wizard. This process is described in the topic [Black Box Tutorial Example 2: Importing a Core Generator Module that Needs a VHDL Wrapper to Satisfy Black Box HDL Requirements](#) and has already been done for you in this example.

During the Black Box creation process, the Black Box Configuration Wizard creates a configuration file named `encrypted_hdl_import_wrapper_config.m`.

Double click on the Black Box in the example design and you will see this config file specified:

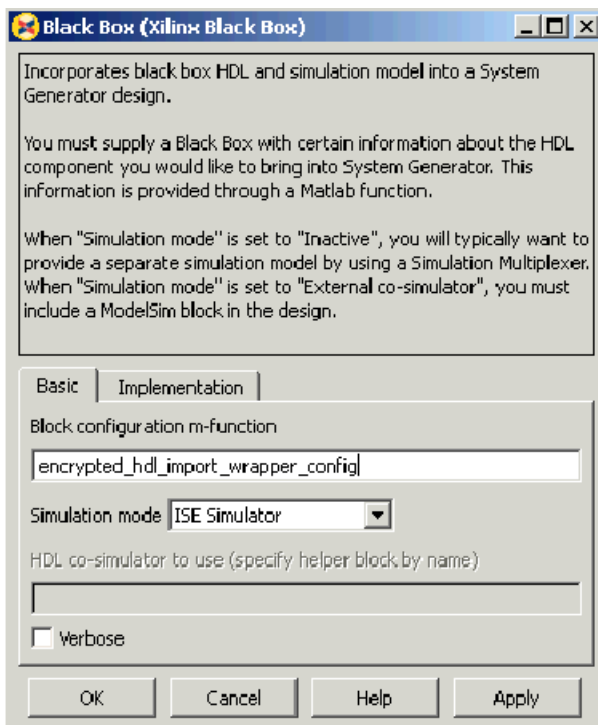

Notice also that the ISE Simulator has been specified as the simulator to use.

3. In order to tell System Generator to netlist the encrypted VHDL file separately, you must open the file `encrypted_hdl_inport_wrapper_config.m` and modify the file by adding the following line:

```
this_block.addFile('encrypted_hdl_import.vhd', 'encrypted_hdl_import.vhd');
```

In the above line, the second parameter in the `addFile` function instructs System Generator to netlist the encrypted file as a separate file and to not include the file in the

consolidated VHDL netlist. The following figure shows how this line has already been added for you in this example:

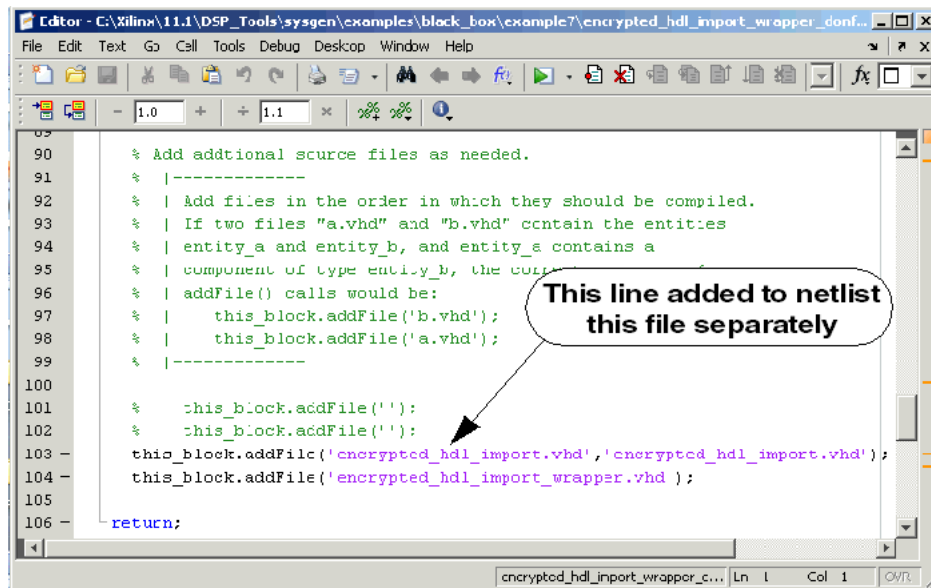

The screenshot shows a text editor window titled "Editor - C:\Xilinx\11.1\DSP\_Tools\sysgen\examples\black\_box\example7\encrypted\_hdl\_import\_wrapper\_def...". The code is as follows:

```
90  % Add additional source files as needed.
91  % |-----
92  % | Add files in the order in which they should be compiled.
93  % | If two files "a.vhd" and "b.vhd" contain the entities
94  % | entity_a and entity_b, and entity_a contains a
95  % | component of type entity_b, the correct
96  % | addFile() calls would be:
97  % |     this_block.addFile('b.vhd');
98  % |     this_block.addFile('a.vhd');
99  % |-----
100
101  %     this_block.addFile('');
102  %     this_block.addFile('');
103  this_block.addFile('encrypted_hdl_import.vhd','encrypted_hdl_import.vhd');
104  this_block.addFile('encrypted_hdl_import_wrapper.vhd ');
105
106  return;
```

A callout bubble with the text "This line added to netlist this file separately" points to line 103. The status bar at the bottom indicates "encrypted\_hdl\_import\_wrapper\_c... Ln 1 Col 1 CTRL".

4. Press the **Simulate** button to simulate the design.  
The simulation results are as shown below.

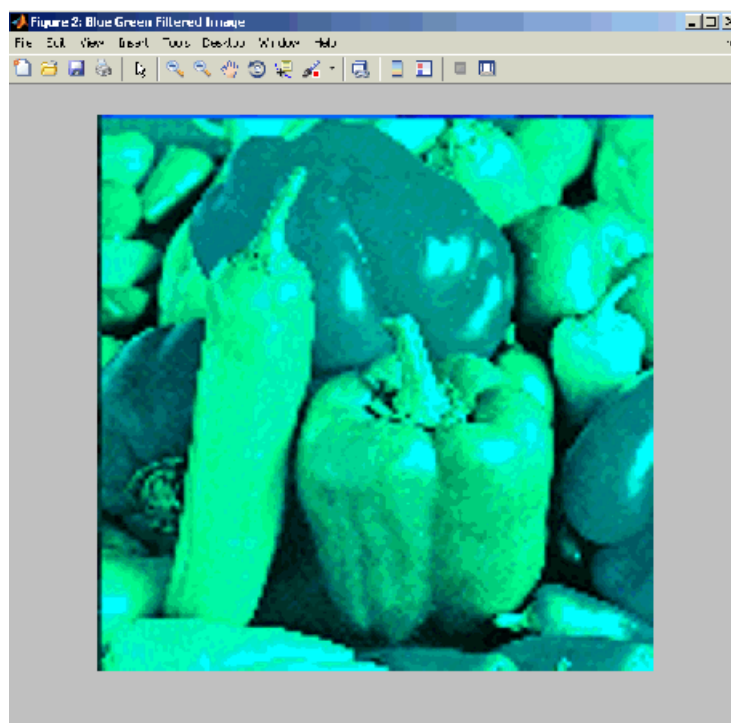
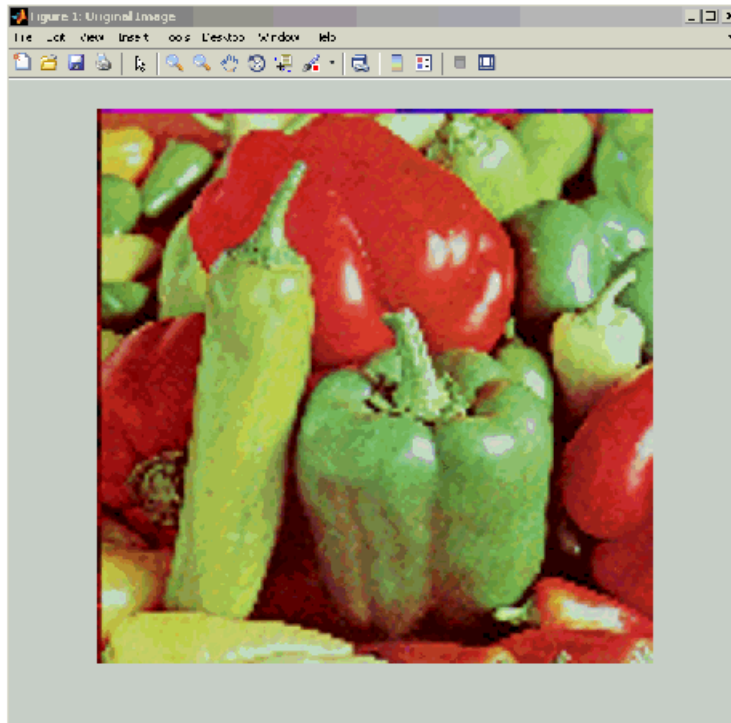

- Double click on the System Generator Token and verify that the Compilation option is set to **HDL Netlist**. Click **Generate**.  
A folder named **hdl** is created inside the **example7** folder.
- Open the **hdl** folder and notice the file named `encrypted_hdl_import.vhd`. Open the file to see that this is the encrypted file that was netlisted separately.

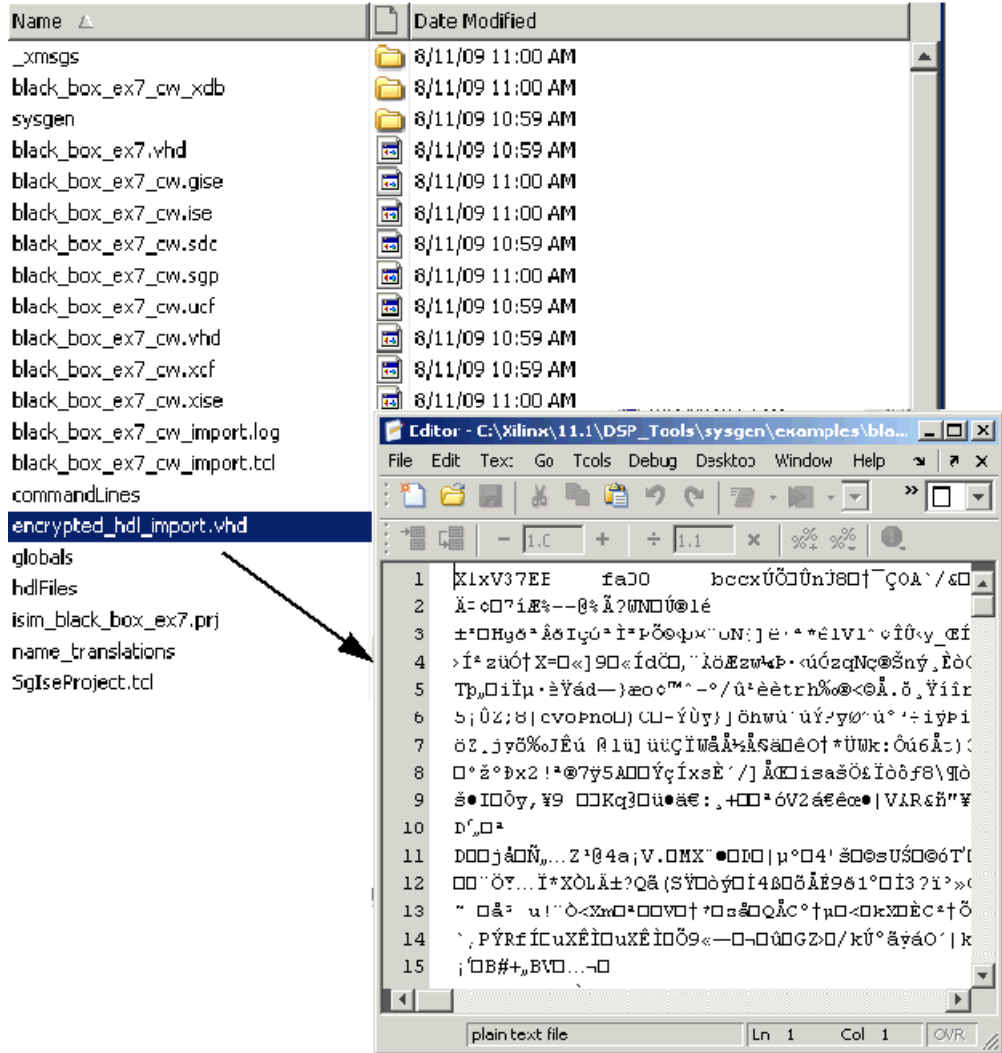

**Note:** The file `encrypted_hdl_import.vhd` is for simulation purposes only. If you want to netlist this design for implementation, you'll need to include another `addFile` line in the configuration file that specifies the NGC file that is created by Core Generator. Refer to the tutorial [Black Box Tutorial Example 2: Importing a Core Generator Module that Needs a VHDL Wrapper to Satisfy Black Box HDL Requirements](#) for an example of how to do this.

## Black Box Tutorial Exercise 9: Prompting a User for Parameters in a Simulink Model and Passing Them to a Black Box

This tutorial exercise describes how to access generics/parameters from a masked counter and pass them onto the black box to override the default local parameters in the VHDL file.

1. Navigate into the directory `<ISE_Design_Suite_tree>/sysgen/examples/example8` directory and open the file `black_box_ex8.mdl`. The model is a simple counter, which includes two input signals (`reset` and `enable`), a subsystem with a black box, and an output signal (`count`). The black box example model is shown below.

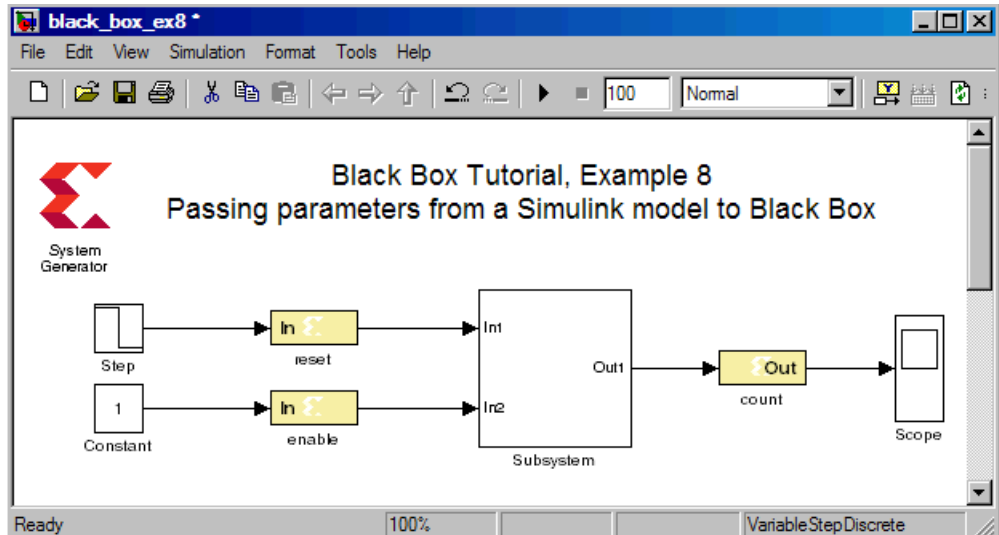

2. Simulate the `black_box_ex8` model. The Simulink waveforms for the `black_box_ex8` simulation are shown below.

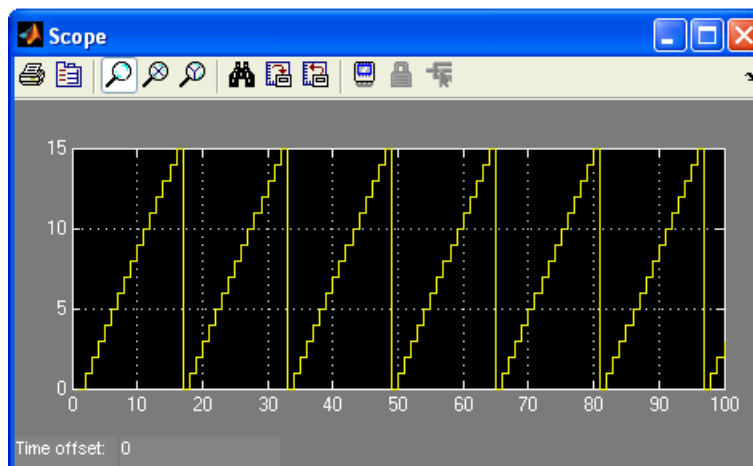

3. Double click on the Subsystem block and change the COUNT\_MAX to a different count value, simulate the design, and verify the count on the WaveScope.

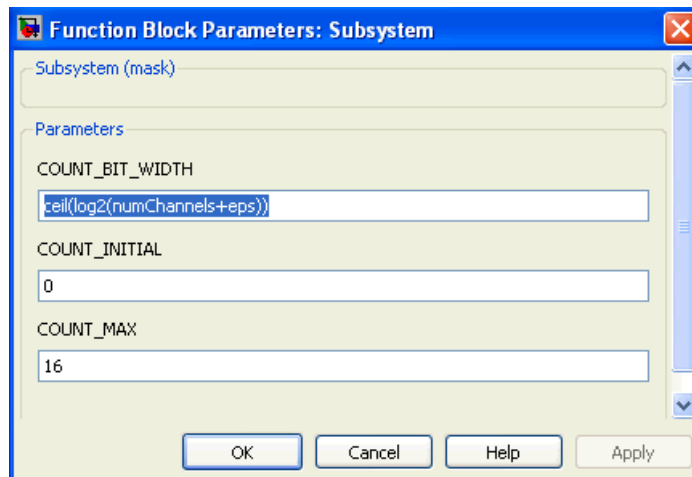

4. Next, take a look at the counter\_config.m file and examine the following lines of M-code that were added to the original machine-generated code by System Generator.
  - a. Access parameters from the masked counter block:

```

% This code is the one that shows how to grab parameters
% from the masked counter block
mybb = this_block.blockName;
masked_counter = get_param(mybb, 'Parent');

% Work around: Create a structure of all the Parameter Names
% and their evaluated values that are on the specified mask
%
% For MaskWSVariables See MATLAB Doc > Mask Parameters > Model and Block
% Parameters > Mask Parameters > About Mask Parameters
%
maskParamNameValuePairs = get_param(masked_counter, 'MaskWSVariables');

% now step through each MASK to get the name and the evaluated value
count_width = -1; %Initial values so to know if Mask is present.
count_init = -1;
count_max = -1;
for i=1:length(maskParamNameValuePairs)
    if (strcmpi(maskParamNameValuePairs(i).Name, 'count_width'))
        count_width = maskParamNameValuePairs(i).Value;
    end
    if (strcmpi(maskParamNameValuePairs(i).Name, 'count_init'))
        count_init = maskParamNameValuePairs(i).Value;
    end
    if (strcmpi(maskParamNameValuePairs(i).Name, 'count_max'))
        count_max = maskParamNameValuePairs(i).Value;
    end
end
end
numChannels = count_max;

```

- b. Set the appropriate bit width for the count output based on the `count_max` value entered by a user.

```
count = this_block.port('count');
if (count_width ~= -1)
    count.setType(['UFix_' num2str(count_width) '_0']);
end
```

- c. Modify the `addGeneric` statements as follows:

```
% Original code
% this_block.addGeneric('COUNT_BIT_WIDTH','integer','4');
% this_block.addGeneric('COUNT_INITIAL','integer','0');
% this_block.addGeneric('COUNT_MAX','integer','15');

% Modified code
this_block.addGeneric('COUNT_BIT_WIDTH','integer',num2str(count_width));
this_block.addGeneric('COUNT_INITIAL','integer',num2str(count_init));
this_block.addGeneric('COUNT_MAX','integer',num2str(count_max));
```

The following is a screen-shot of the parameters that are declared at the beginning of the `counter.vhd` file.

```
entity counter is
    generic (
        COUNT_BIT_WIDTH           : integer := 4;
        COUNT_INITIAL             : integer := 0;
        COUNT_MAX                 : integer := 15
    );
```



# System Generator Compilation Types

---

There are different ways in which System Generator can compile your design into an equivalent, often lower-level, representation. The way in which a design is compiled depends on settings in the System Generator dialog box. The support of different compilation types provides you the freedom to choose a suitable representation for your design's environment. For example, an HDL or NGC netlist is an appropriate representation when your design is used as a component in a larger system. If, on the other hand, the complete system is modeled inside System Generator, you may choose to compile your design into an FPGA configuration bitstream. Sometimes you may want to compile your design into an equivalent high-level module that performs a specific function in applications external to System Generator (e.g., ModelSim hardware co-simulation).

## [HDL Netlist Compilation](#)

System Generator uses the HDL Netlist compilation type as the default generation target. More details regarding the HDL Netlist compilation flow can be found in the topic [Compilation Results](#).

## [NGC Netlist Compilation](#)

Describes how System Generator can be configured to compile your design into a standalone NGC file.

## [Bitstream Compilation](#)

Describes how System Generator can be configured to compile your design into an FPGA configuration bitstream.

## [EDK Export Tool](#)

Describes how System Generator can be configured to compile your design into an FPGA configuration bitstream that is appropriate for the selected part.

## [Hardware Co-Simulation Compilation](#)

Describes how System Generator can be configured to compile your design into FPGA hardware that can be used by Simulink and ModelSim.

## [Timing and Power Analysis Compilation](#)

Describes how to use the System Generator Timing and Power Analysis tools on the compilation target.

## [Creating Compilation Targets](#)

Describes how to add custom compilation targets to the System Generator token.

## HDL Netlist Compilation

System Generator uses the **HDL Netlist** compilation type as the default generation target. More details regarding the HDL Netlist compilation flow can be found in the sub-topic titled [Compilation Results](#).

As shown below, you may select **HDL netlist** compilation by left-clicking the **Compilation** submenu control on the System Generator token dialog box, and select the **HDL Netlist** target.

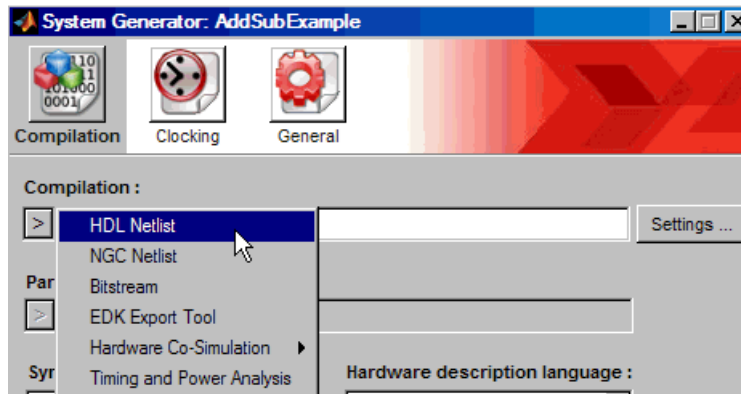

## NGC Netlist Compilation

The **NGC Netlist** compilation target allows you to compile your design into a standalone Xilinx NGC binary netlist file. The NGC netlist file that System Generator produces contains the logical and optional constraint information for your design. This means the HDL, cores, and constraints file information corresponding to a System Generator design are self-contained within a single file.

If you have chosen to include clock wrapper logic in your design, the netlist file is saved as `<design>_cw.ngc`. Otherwise, the file is saved as `<design>.ngc`. Here `<design>` is derived from the portion of the design being compiled. This file can be used as a module in a larger design, or as input to **NGDBuild** when the netlist constitutes the complete design. For an example showing how a System Generator design can be used as a component in a larger design, refer to the topic titled [Importing a System Generator Design into a Bigger System](#).

The NGC compilation target generates an HDL component instantiation template that makes it easy to include your System Generator design as a component in a larger design. For VHDL compilation, the template is saved as `<design>_cw.vho` when the clock wrapper is included. Otherwise it is saved as `<design>.vho`. Alternatively, a `.veo` extension is used for Verilog compilation. The instantiation template is saved in the design's target directory.

System Generator produces the NGC netlist file by performing the following steps during compilation:

1. Runs the selected synthesis tool to produce a lower-level netlist. The type of netlist (e.g., EDIF for Synplify or Synplify Pro, NGC for XST) depends on which synthesis tool is chosen for compilation.

**Note:** Note: IO buffers are not inserted in the design during synthesis.

2. Combines synthesis results, core netlists, black box netlists, and optionally the constraints files into a single NGC file.

As shown below, you may select the NGC compilation target by left-clicking the **Compilation** submenu control on the System Generator token dialog box, and selecting the **NGC Netlist** target.

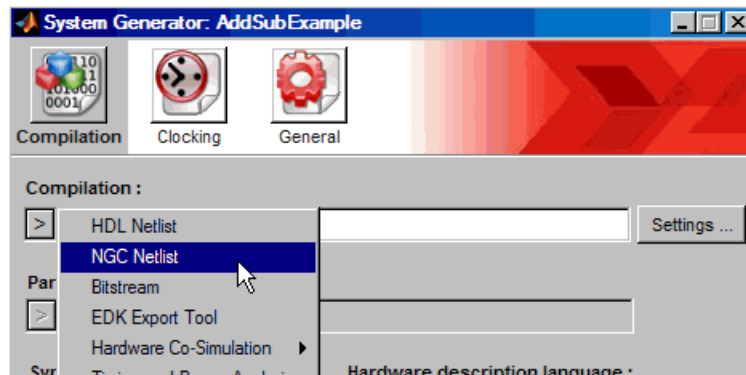

You may access additional compilation settings specific to **NGC Netlist** compilation by clicking on the **Settings...** button when **NGC Netlist** is selected as the compilation type in the System Generator token dialog box. Parameters specific to the NGC Netlist Settings dialog box include:

- Include Clock Wrapper:** Selecting this checkbox tells System Generator whether the clock wrapper portion of your design should be included in the NGC netlist file. Refer to the topic [Compilation Results](#) for more information on the clock wrapper.
 

**Note:** If you exclude the clock wrapper from multirate designs, you will need to drive the clock enable ports with appropriate signals from your own top-level design.
- Include Constraints File:** Selecting this checkbox tells System Generator whether the constraints file associated with the design should be included in the NGC netlist file.
 

**Note:** When the constraints file is excluded, you should supply your own constraints to ensure the multi-cycle paths in the System Generator design are appropriately constrained.

## Bitstream Compilation

The Bitstream compilation type allows you to compile your design into a Xilinx configuration bitstream file that is suitable for the FPGA part that is selected in the System Generator dialog box. The bitstream file is named `<design>_cw.bit` and is placed in the design's target directory, where `<design>` is derived from the portion of the design being compiled.

System Generator produces the bitstream file by performing the following steps during compilation:

- Generates an HDL netlist for the design;
- Runs the selected synthesis tool to produce a lower-level netlist. The type of netlist (e.g., EDIF for Synplify Pro, NGC for XST) depends on which synthesis tool is chosen for compilation.
- Runs **XFLOW** to produce a configuration bitstream.

As shown below, you may select the Bitstream compilation by left-clicking the **Compilation** submenu control on the System Generator token dialog box, and selecting the **Bitstream** target.

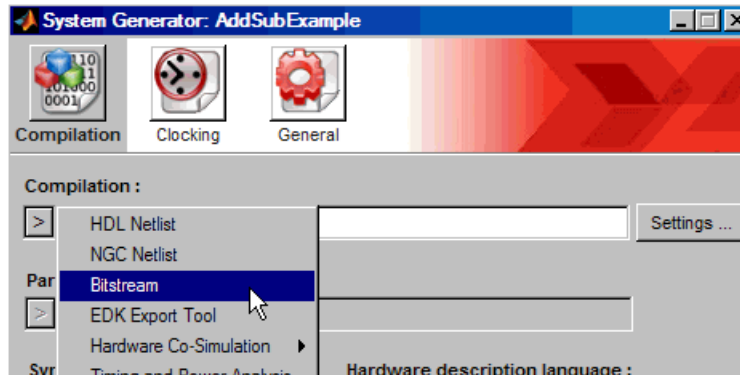

System Generator uses XFLOW to run the tools necessary to produce the configuration bitstream. Execution of XFLOW is broken into two flows, *implementation* and *configuration*.

The implementation flow is responsible for compiling the synthesis tool netlist output (e.g., EDIF or NGC) into a placed and routed NCD file. In summary, the implementation flow performs the following tasks:

1. Combines synthesis results, core netlists, black box netlists, and constraints files using NGDBuild.
2. Runs MAP, PAR, and Trace on the design (in that particular order).

The configuration flow type runs the tools (e.g., BitGen) necessary to create an FPGA BIT file, using the fully elaborated NCD file as input.

## XFLOW Option Files

The implementation and configuration flow types have separate XFLOW options files associated with them. An XFLOW options file declares the programs that should be run for a particular flow, and defines the command line options that are used by these tools. The Xilinx ISE® software includes several example XFLOW options files. From the base directory of your Xilinx ISE software tree, these files are located under the `xilinx\data` directory. Three commonly used implementation options files include:

- `balanced.opt`;
- `fast_runtime.opt`;
- `high_effort.opt`.

**Note:** By default, System Generator uses the `balanced.opt` file for the implementation flow, and `bitgen.opt` file for the configuration flow.

Sometimes you may want to use options files that use settings that differ (e.g., to specify a higher placer effort level in PAR) from the default options provided by the target. In this case, you may create your own options files, or edit the default options files to include your desired settings. The Bitstream settings dialog box allows you to specify options files other than the default files.

## Additional Settings

You may access additional compilation settings specific to Bitstream compilation by clicking on the **Settings...** button when **Bitstream** is selected as the compilation type in the System Generator token dialog box. Parameters specific to the Bitstream Settings dialog box include:

- **Import Top-level Netlist:** Allows you to specify your own top-level netlist into which the System Generator portion of the design is included as a module. You may choose to import your own top-level netlist if you have a larger design that instantiates the System Generator clock wrapper level as a component. Refer to the [Compilation Results](#) topic for more information on the clock wrapper level. This top-level netlist is included in the bitstream file that is generated during compilation. Selecting this checkbox enables the edit fields Top-level Netlist File (EDIF or NGC) and Search Path for Additional Netlist and Constraint Files.
  - ◆ **Top-level Netlist File (EDIF or NGC):** Specifies the name and location of the top-level netlist file to include during compilation. Note that any HDL components that are used by your top-level (including the top-level itself) must have been previously synthesized into netlist files.
  - ◆ **Search Path for Additional Netlist and Constraint Files:** Specifies the directory where System Generator should look for additional netlist and constraint files that go along with the top-level netlist file. System Generator copies all netlist (e.g., .edn, .edf, .ngc) and constraints files (e.g., .ucf, .xcf, .ncf) into the implementation directory when this directory is specified. If you do not specify a directory, System Generator will only copy the netlist file specified in the **Top-level Netlist File** field.
- **Specify Alternate Clock Wrapper:** Allows you to substitute your own clock wrapper logic in place of the clock wrapper HDL System Generator produces. The clock wrapper level is the top-level HDL file that is created for a System Generator design, and is responsible for driving the clock and clock enable signals in that design. Sometimes you may want to supply your own clock wrapper, for example, if your design uses multiple clock signals, or if you have a board-specific hardware you would like your design to interface to.

**Note:** The name of the alternate clock wrapper file must be named `<design>_cw.vhd` or `<design>_cw.v` or it will not be used during bitstream generation.
- **XFLOW Option Files:** When a design is compiled for System Generator hardware co-simulation, the command line tool, XFLOW, is used to implement and configure your design for the selected FPGA platform. XFLOW defines various flows that determine the sequence of programs that should be run on your design during compilation. There are typically multiple flows that must be run in order to achieve the desired output results, which in the case of hardware co-simulation targets, is a configuration bitstream.
  - ◆ **Implementation Phase (NBDBuild, MAP, PAR, TRACE):** Specifies the options file that is used by the implement flow type. By default, System Generator will use the implement options file that is specified by the compilation target.
  - ◆ **Configuration Phase (BitGen):** Specifies the options file that is used by the configuration flow type. By default, System Generator will use the configuration options file that is specified by the compilation target.

## Re-Compiling EDK Processor Block Software Programs in Bitstreams

When you perform bitstream compilation on a System Generator design with an EDK Processor block, the imported EDK project and the shared memories sitting between the System Generator design and MicroBlaze™ processor are netlisted and included in the resulting bitstream.

System Generator also tries to compile any active software programs inside the imported EDK project. If the compilation of active software programs succeeds, System Generator invokes the **data2bram** utility to include the compiled software programs into the resulting bitstream.

**Note:** No error or warning message is issued when System Generator encounters failures during software program compilation or when System Generator updates the resulting bitstream with the compiled software programs.

You can modify the software programs in the imported EDK project and use the following command to compile the software programs, and update the System Generator bitstream with the compiled software programs:

```
xlProcBlockCallbacks('updatebitstream', [], xmp_file, bit_file,  
bmm_file);
```

where

**xmp\_file** is the pathname to the imported EDK project file  
**bit\_file** is the pathname to the Sysgen bitstream file  
**bmm\_file** is the pathname of the back-annotated BMM file produced by Sysgen during bitstream compilation

If the imported EDK project contains a BMM file named `imported_edk_project.bmm`, System Generator creates a back-annotated BMM file named `imported_edk_project_bd.bmm`. You should provide the later back-annotated BMM file to the above command in order to update the bitstream properly.

## EDK Export Tool

The EDK Export Tool allows a System Generator design to be exported to a [Xilinx Embedded Development Kit \(EDK\)](#) project. The EDK Export Tool simplifies the process of creating a peripheral by automatically generating the files required by the EDK.

The EDK Export Tool can be accessed from the System Generator token GUI under the Compilation pull-down menu – the figure below shows this being done. After the EDK Export Tool is selected, the **Settings...** button will be enabled.

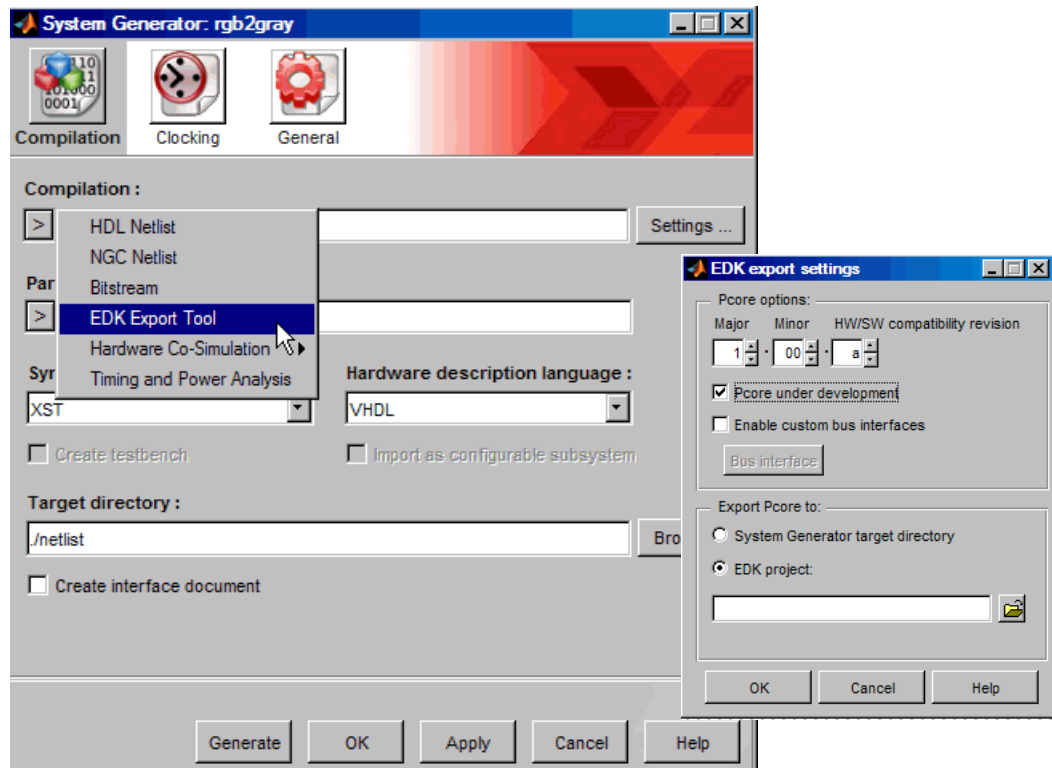

Clicking on the **Settings...** button brings up the EDK export settings dialog.

**Pcore options** allow you to do the following:

- Assign a version number to your pcore
- Select **Pcore under development**

When a pcore is marked as **Pcore under development**, XPS will not cache the HDL produced for this pcore. This is useful when you are developing pcores in System Generator and testing them out in XPS. You can just enable this checkbox, make changes in System Generator and compiled in XPS. XPS always compiles the generated pcore, so you don't have to empty the XPS cache which may contain caches of other peripherals, thus slowing down the compile of the final bitstream.

- Select **Enable custom bus interfaces**

This feature allows you to create custom bus interfaces that will be understood in XPS.

## Creating a Custom Bus Interface for Pcore Export

Consider the following example. In the model below, you have one design that you are going to export as a pcore to XPS. This design has the output ports **Pixel Enable**, **Y**, **Cr**, and **Cb**. You want to group these signals into a bus to simplify the connection in XPS.

The figure illustrates the steps to create a custom bus interface for pcore export in the System Generator. The process is shown in six numbered steps:

- 1. Double Click**: A double-click action is performed on the System Generator icon in the block diagram.
- 2. Select**: The "Export as a pcore to EDK" option is selected in the "Compilation" settings dialog.
- 3. Click**: The "Settings ..." button is clicked to open the "EDK export settings" dialog.
- 4. Select**: The "Enable custom bus interfaces" checkbox is selected in the "EDK export settings" dialog.
- 5. Click**: The "Bus interface" button is clicked to open the "Bus Interface" configuration dialog.
- 6. Enter**: The "Enter" key is pressed to confirm the configuration in the "Bus Interface" dialog.

The "Bus Interface" dialog shows the following configuration:

Bus Name	Bus Standard	Bus Type
1 vid_out	myVideoBus	INITIATOR

  

Gateway Name	Bus Interface Name	Bus Name
1 Pixel Enable	pe	vid_out
2 Y	y	vid_out
3 Cr	c'	vid_out
4 Cb	cb	vid_out



You follow the sequence in the previous figure to bring up the **Bus Interface** dialog box. In this dialog box, you define a new Bus Interface called **vid\_out** that is marked as a **myVideoBus** Bus Standard and is Bus Type **INITIATOR**. (Other supported Bus Types include: Target, Master, Slave, Master-slave, Monitor.) Next, in the Port-Bus Mapping table, you list all the gateways that you want in the bus, then give each a Bus Interface Name. You then Netlist the design as a pcore. Remember that you marked this pcore bus as **INITIATOR** since it contains outputs.

In another model (shown below), you create corresponding input gateways. You set this up as a **TARGET** bus giving the bus interface the same Bus Standard **myVideoBus**. XPS will use the Bus Standard name to match different bus interfaces. XPS will then connect the outputs to the inputs with the same Bus Interface Names.

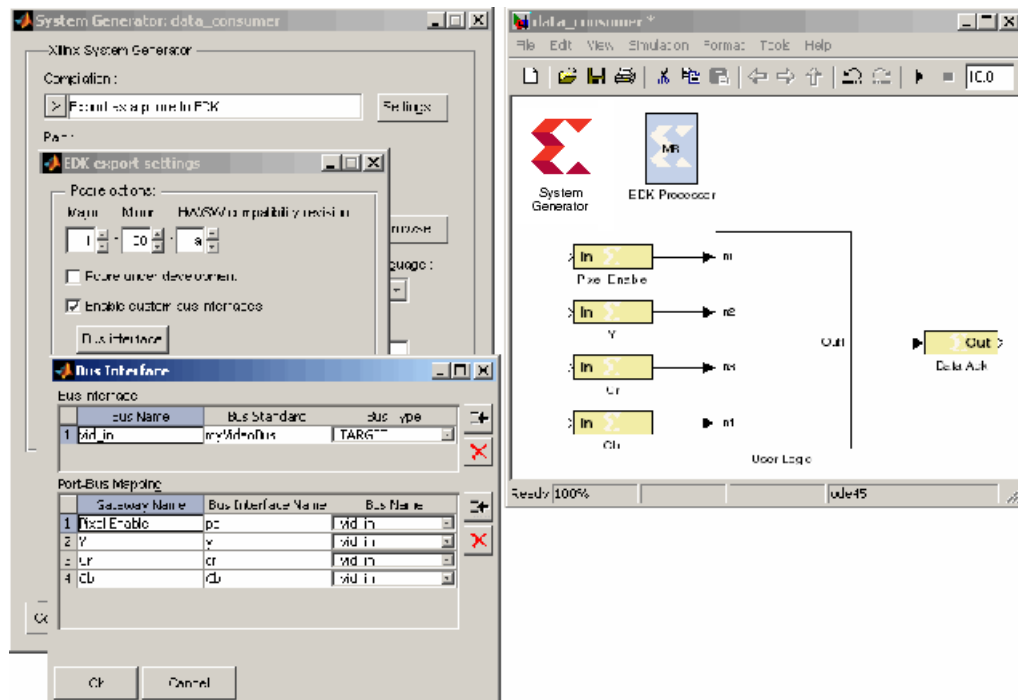

You export this pcore to the XPS project. When these two pcors are used in the same XPS project, XPS will detect that they have compatible buses and will allow you to connect them if you wish.

## Export as Pcore to EDK

When a System Generator design is exported to the EDK, the name of the pcore (processor core) has the postfix **"\_plbw"** appended to the model name if a PLB v6.4 bus is specified. For example, when a model called **mul\_accumulate** is exported to the EDK, it will be called **mul\_accumulate\_plbw** on the EDK side. If Fast Simplex Link is specified, the postfix **"\_sm"** is appended to the model name.

The following table shows subdirectory structure of the pcore that is generated by System Generator:

pcore Subdirectory	Description
data	The data directory contains four files: BBD, PAO, MPD and TCL. <ul style="list-style-type: none"> <li>• The BBD (black-box definition) file tells the EDK what EDN or NGC files are used in the design.</li> <li>• The PAO (peripheral analyze order) file tells the EDK the analyze order of the HDL files.</li> <li>• The MPD (Microprocessor Peripheral Description) file tells the EDK how the peripheral will connect to the processor.</li> <li>• The TCL file is used by LibGen when elaborating software drivers for this peripheral.</li> </ul>
doc	Documentation files in HTML format.
hdl	The hdl directory contains the hdl files produced by System Generator.
netlist	The netlist directory contains the EDN and NGC files listed by the BBD file
src	Source files for the software drivers.

## System Generator Ports as Top-Level Ports in EDK

Input and output ports created in System Generator are made available to the EDK tool as ports on the peripheral. You may pull these ports to the top-level of the EDK design. This is useful for instance when the System Generator design has ports that go to the input/output pads on the FPGA device.

## Supported Processors and Current Limitations

Currently, PLB v4.6 memory-map links to the MicroBlaze™ processor are exported with the EDK Export Tool. There can only be one instance of an EDK Processor block.

See Also:

[EDK Processor](#)

## Hardware Co-Simulation Compilation

System Generator can compile designs into FPGA hardware that can be used in the loop with Simulink simulations. This capability is discussed in the topic [Using Hardware Co-Simulation](#).

You may select a hardware co-simulation target by left-clicking the **Compilation** submenu control on the System Generator dialog box, and selecting the desired hardware co-simulation platform. The list of available co-simulation platforms depends on which hardware co-simulation plugins are installed on your system.

**Note:** If you have an FPGA platform that is not listed as a compilation target, you may create a new System Generator compilation target that uses JTAG to communicate with the FPGA hardware. Refer to the [Supporting New Boards](#) for more information on how to do this.

## Timing and Power Analysis Compilation

Sometimes the hardware created by System Generator may not meet the requested timing requirements. System Generator provides a Timing and Power Analysis tool flow that can help you resolve timing and power related issues. The timing analysis tool shows you, both in graphical and textual formats, the slowest system paths and those paths that are failing to meet the timing requirements. This allows you to concentrate on methods of speeding up those paths. Methods for doing so will be discussed. Underlying the System Generator Timing Analysis tool is Trace, a software application delivered as part of the ISE® software used to analyze timing paths.

As shown below, you invoke the Timing Analyzer by double-clicking on the System Generator token and selecting the **Timing and Power Analysis** option from the **Compilation** submenu. Specify the optional **Power Analysis** option and the the exact device you wish to target as the size and speed of the device will affect the path delays. Result files will be put in the **Target Directory**. The value in the **FPGA Clock Period** box is the value that will be used during place & route:

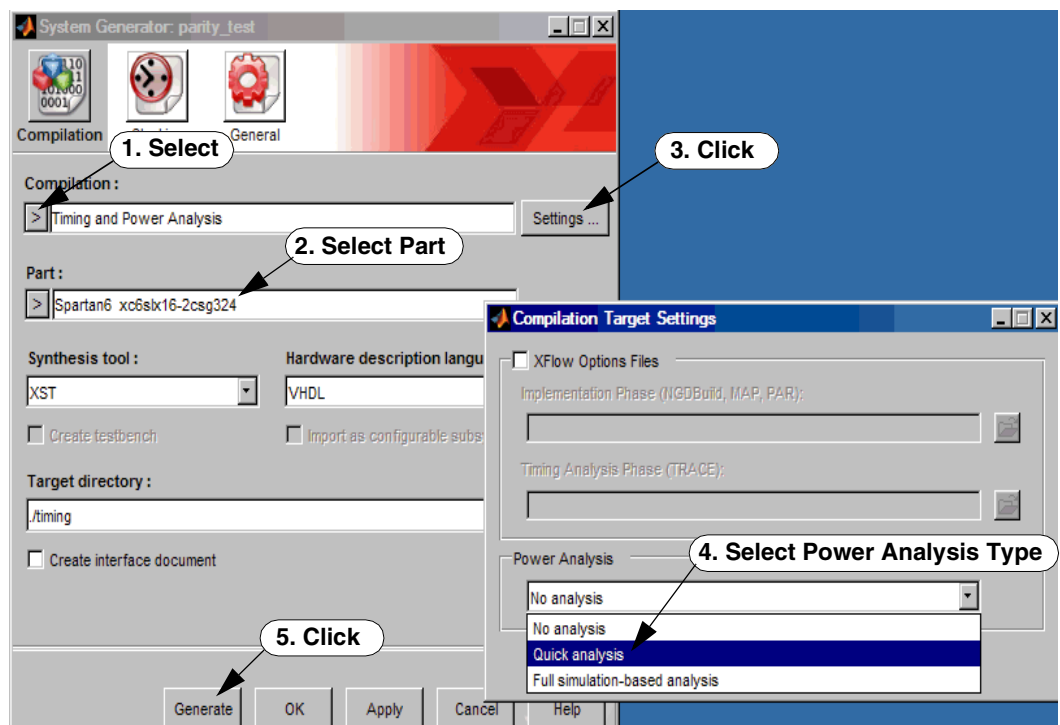

After filling out the dialog box, click the **Generate** button and System Generator will perform the following steps:

1. The design is compiled using Simulink then netlisted by Sysgen into HDL source.
2. If you selected the Power Analysis option **Full simulation-based analysis**, the ISim simulator is called to simulate the HDL design. The HDL **Synthesis Tool** is then called to turn the HDL into an EDIF (Synplify /Synplify Pro) or NGC (XST) netlist.
3. NGD Build is called to next to turn the netlist into an NGD file. The ISE Mapper software is then called to map elements of logic together into slices; this creates an NCD file.
4. The ISE Place & Route software is then called to place the slices and other elements on the Xilinx die and to route the connections between the slices. This creates another NCD file.
5. The ISE Trace software is then called to analyze the second NCD file and find the paths with the worst slack. This creates a trace report. The System Generator Timing Analyzer tool appears, displaying the data from the trace report.

**Note:** If timing data is generated using this method and you wish to view it again at a later time, then you can enter the following command at the MATLAB command line:

```
>>xlTimingAnalysis('timing')
```

where 'timing' is the name of the target directory in which a prior analysis was carried out.

6. As shown below, you can click the **Power Analysis** button on the Timing Analyzer window to bring up the Xilinx XPower Analysis tool report.

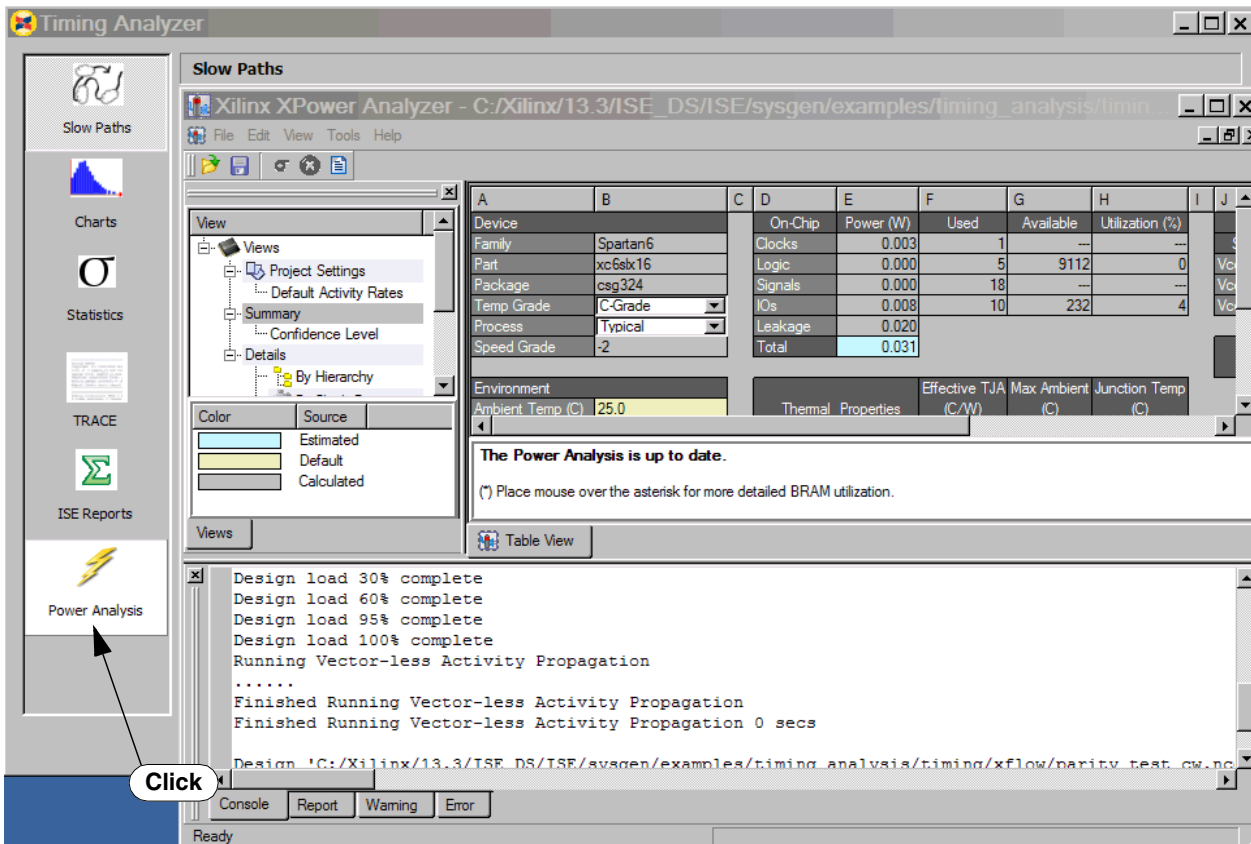

A	B	C	D	E	F	G	H	I	J
Device		On-Chip	Power (W)	Used	Available	Utilization (%)			
Family	Spartan6	Clocks	0.003	1	---	---			
Part	xc6s16	Logic	0.000	5	9112	0	Ve		
Package	csg324	Signals	0.000	18	---	---	Ve		
Temp Grade	C-Grade	IOs	0.008	10	232	4	Ve		
Process	Typical	Leakage	0.020						
Speed Grade	-2	Total	0.031						

```

Design load 30% complete
Design load 60% complete
Design load 95% complete
Design load 100% complete
Running Vector-less Activity Propagation
.....
Finished Running Vector-less Activity Propagation
Finished Running Vector-less Activity Propagation 0 secs
Design 'C:/Xilinx/13.3/ISE_DS/ISE/sysgen/examples/timing_analysis/timing/xflow/parity_test_cw.nc
  
```

## Timing Analysis Concepts Review

This brief topic is intended for those with little or no knowledge of logic path analysis.

### Period and Slack

A timing failure usually means there is a setup time violation in the design. A setup time violation means that a particular signal cannot get from the output of one synchronous element to the input of another synchronous element within the requested clock period and subject to the second synchronous element's setup time requirement. A typical path is shown in the following schematic:

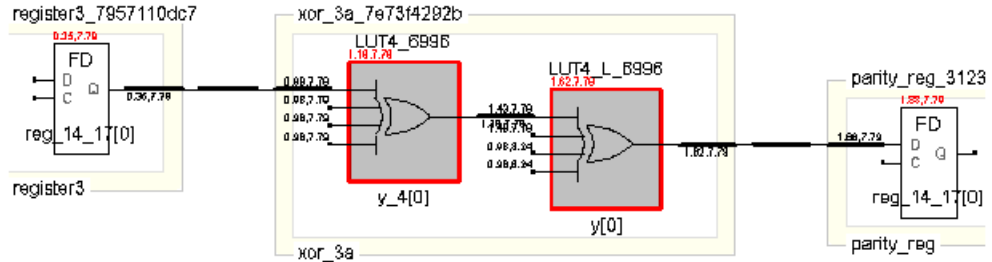

The path shown is from the Q output of the register on the left (*register3*) to the D input of the register on the right (*parity\_reg*). The path goes through two LUTs (lookup tables) that are configured as 4-input XOR gates. This path has two levels of logic. That means that it goes through two separate combinational elements (the two LUTs).

The requested period for this path is 10ns. This path easily meets timing. The second of the two red comma-separated numbers above each logic element shows the *slack* for the path. The slack is the amount of time by which the path 'meets timing'. In this case the slack is 7.79ns. That means that the path could be 7.79ns slower and still meet the 10ns period requirement. A negative slack value indicates that the path does not meet timing and has a setup (or hold) time violation.

### Path Analysis Example

Let us examine this path in more detail. The first value on the top of *register3* is 0.35ns. This means that the clk-to-out time of the register is 0.35ns, so the data will appear on the Q output 0.35ns after the rising edge of the clock signal. (The clock signal, not shown, drives the C inputs of both registers.)

The input of the LUT *y\_4[0]* shows two numbers on each input. The first is the arrival time of the signal. This value is 0.98ns. This means that the signal arrives at the input 0.98ns after the rising edge of the clock. Therefore the net delay is  $(0.98\text{ns} - 0.35\text{ns}) = 0.63\text{ns}$ . Any path delay is divided into net delays and logic delays. In an FPGA, the net delays are normally the predominant type of delay. This is because the configurable routing fabric of the FPGA requires that a net traverse many delay-inducing switchboxes in order to reach its destination.

The path leaves *y\_4[0]* and travels along another net to *y[0]*. The first of the two values at the output of *y[0]* shows the arrival time of the signal at the output of that LUT. This value is 1.62ns. The signal travels along the final net, incurring a net delay of 0.26ns to arrive at the D input of *parity\_reg* at 1.88ns after the clock edge. This register has a required *setup time*. The setup time for this register is 0.33ns. This means that the signal must arrive at the D input 0.33ns before the rising edge of the next clock. Therefore the total path requires  $(1.88\text{ns} + 0.33\text{ns}) = 2.21\text{ns}$ . Subtracted from 10ns, this yields the 7.79ns slack value.

## Clock Skew and Jitter

The net delay values shown here are estimates provided by Synplify. The synthesizer doesn't know the actual net delay values because these are not determined until after the place & route process. An actual path contains other variables which must be accounted for, including clock skew and clock jitter. *Clock skew* is the amount of time between clock arrival at the source and destination synchronous elements. *Clock jitter* is a variation of the clock period from cycle to cycle. Jitter is created by the DCMs (digital clock managers) and by other means. The timing analysis is carried out with worst-case values for the given part's delay values, jitter, skew, and temperature derating.

## Timing Analyzer Features

### Observing the Slow Paths

Clicking on the Slow Paths icon displays the paths with the least slack for each timing constraint. An example is shown below:

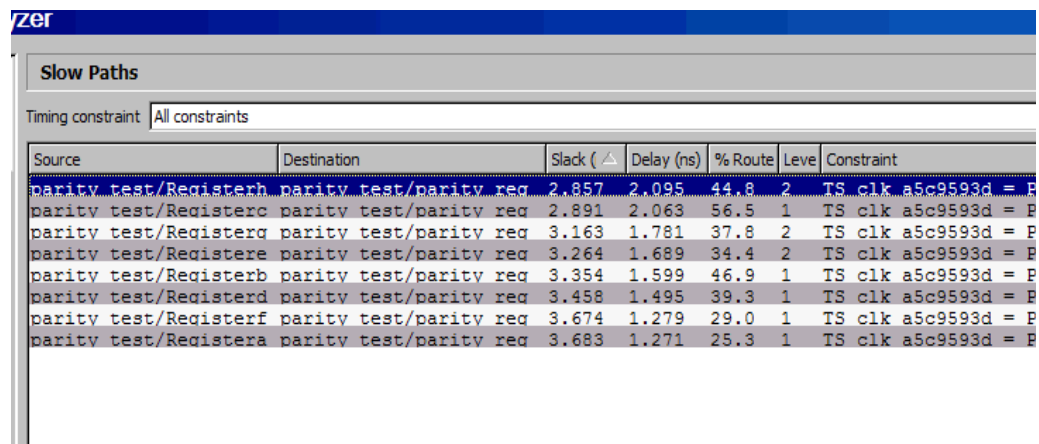

Source	Destination	Slack (ns)	Delay (ns)	% Route	Level	Constraint
parity test/Registerh	parity test/parity reg	2.857	2.095	44.8	2	TS_clk_a5c9593d = P
parity test/Registerc	parity test/parity reg	2.891	2.063	56.5	1	TS_clk_a5c9593d = P
parity test/Registera	parity test/parity reg	3.163	1.781	37.8	2	TS_clk_a5c9593d = P
parity test/Registere	parity test/parity reg	3.264	1.689	34.4	2	TS_clk_a5c9593d = P
parity test/Registerb	parity test/parity reg	3.354	1.599	46.9	1	TS_clk_a5c9593d = P
parity test/Registerd	parity test/parity reg	3.458	1.495	39.3	1	TS_clk_a5c9593d = P
parity test/Registerf	parity test/parity reg	3.674	1.279	29.0	1	TS_clk_a5c9593d = P
parity test/Registera	parity test/parity reg	3.683	1.271	25.3	1	TS_clk_a5c9593d = P

The top section of the display shows a list of slow paths, while the bottom section of the display shows details of the path that is selected. The elements of this display are explained here:

- **Timing Constraint:** You may opt to view the paths from all timing constraints or just a single constraint. A typical System Generator design has but a single timing constraint which defines the period of the system clock. This is the constraint shown in this example. `TS_clk_a5c9593d` is the name of the constraint; the (sometimes confusing) suffix is a hash meant to make the identifier unique when multiple System Generator designs are used as components inside a larger design. The timing group `clk_a5c9593` is a group of synchronous logic, again with a hash suffix. The group in this case contains all the synchronous elements in the design. The period of the clock here is 10ns with a 50% duty cycle.
- **Source:** The System Generator block that drives the path.
- **Destination:** This is the System Generator block that is the terminus of the path.
- **Slack:** The slack for this particular path. See the topic entitled [Period and Slack](#) for more details.
- **Delay (Path):** The delay of the entire path, including the setup time requirement.
- **% Route Delay:** This is the percentage of the path that is consumed by routing (net) delay. The remainder portion of the path is consumed by logic delay.

- **Levels of Logic:** The number of levels of combinatorial logic in the path. The combinatorial logic typically comprises LUTs, F5 muxes, and carry chain muxes.
- **Path Element:** This shows the logic and net elements in the highlighted path.
- **Delay (Element):** This shows the delay through the logic and net elements in the highlighted path.
- **Type of Delay:** This is the kind of delay incurred by the given path element. These values are defined in the Xilinx part's data sheet. In the example shown above, *Tcko* is the clk-to-out time of a flip-flop; *net* is a net delay; *Tilo* is the delay through a LUT, and *Tas* is the setup time of a flip-flop.

You may click on the column headings to reorder the paths or elements according to delay, slack, path name, or other column headings. Failing paths are highlighted in red/pink.

### Name Unmunging and Displaying Low-Level Names

Part of the magic of the timing analyzer lies in its ability to perform the un-glorious task of *name unmunging*, the task of automatically correlating System Generator components with the low-level component names produced by the Xilinx implementation tools. The names of these components often differ considerably. In fact, the logic blocks and wires that appear in a System Generator diagram may have only a loose relation to the actual logic that gets generated during the synthesis process. The System Generator timing analyzer must correlate the names of logic elements and nets in the trace report to blocks and wires in the System Generator diagram.

The timing analyzer cannot always perform this un-munging process. In the path shown in the screen capture above, path elements #2 and #5 have a question mark displayed in the name field. This means that the timing analyzer could not un-munge the name from the trace report and correlate it to a System Generator block.

To see the actual names from the trace report, check the *Display low-level names* box. This will show the trace report names. You may be able to correlate them to System Generator elements by observation.

### Cross-Probing

Highlighting a path in the *Slow Paths* view will highlight the blocks in the path in the System Generator diagram. The path's source and destination blocks, as well as combinational blocks through which the path passes, will be highlighted in red. The diagram below shows how the model appears when the path that has Registerc as its



source and parity\_reg as its destination is highlighted. The blocks xor\_1b, xor\_2a, and xor\_3a are also highlighted because they are part of the path.

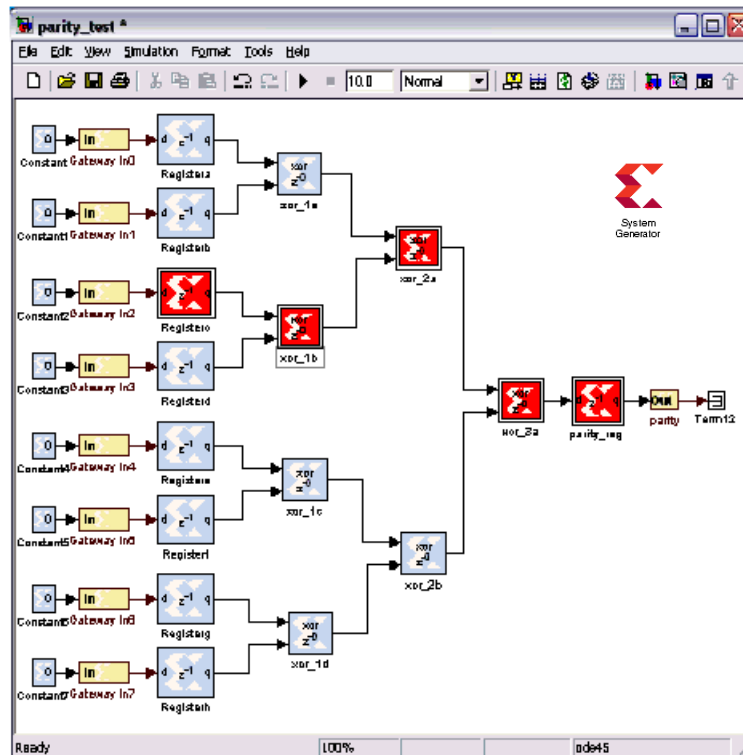

## Histogram Charts

Clicking on the Charts icon displays a histogram of the slow paths. This histogram is a useful metric in analyzing the design. You may know that the design will only run at, for example, 99MHz in your part when you wish it to run at 100MHz. But how close is the design to meeting timing and how much work is involved in meeting this requirement?



The histogram will quickly give you an estimate of the work involved. For example, look at the histogram of the results of a simple design below:

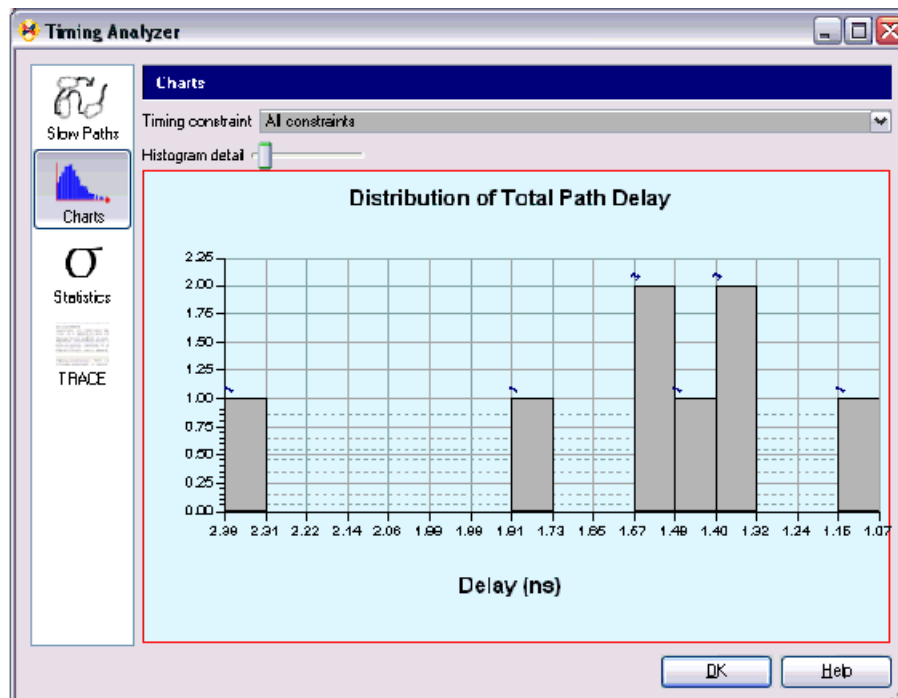

This shows that most of the slow paths are concentrated about 1.5ns. The slowest path is about 2.35ns. The numbers at the tops of the bins show the number of paths in each bin. There is only one path in the bin which encompasses the time range 2.31ns-2.39ns. The bins to the right of it are empty. This shows that the slowest path is an outlier and that if your timing requirement were for a period of, for example, 2ns, you would need only to speed up this single path to meet your timing requirements.

## Histogram Detail

The slider bar allows you to adjust the width of the bins in the histogram. This allows you to get more detail about the paths if desired. The display below shows the results of a different design with a larger number of bins than the diagram above:

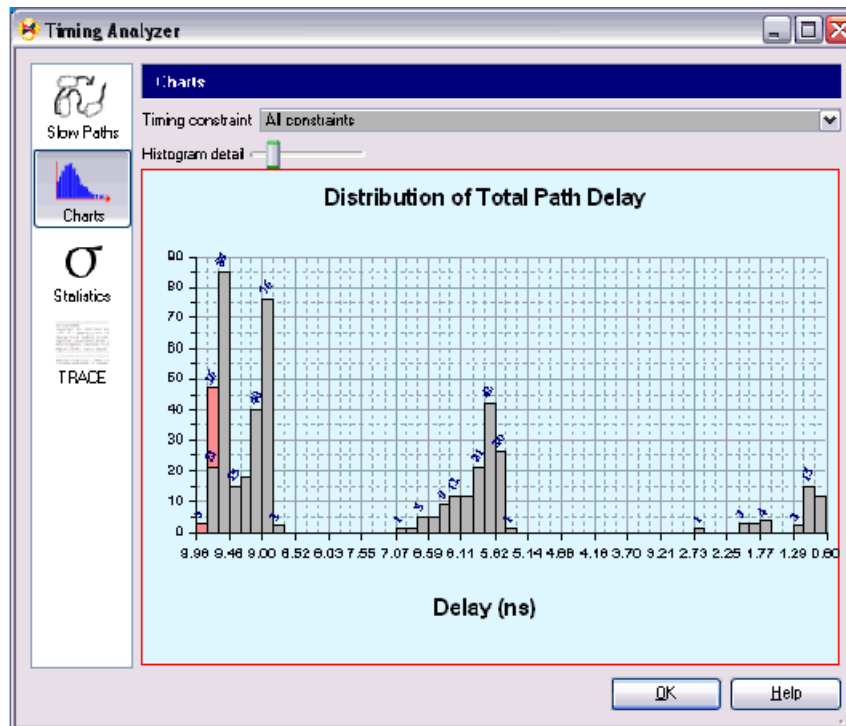

This diagram shows the paths grouped into three regions, with each forming a rough bell curve distribution. These groups are probably from different portions of the circuit or from different timing constraints that are from different clock regions. If you wish to analyze the paths from a single timing constraint, you may select a single constraint for viewing from the Timing constraint pulldown menu at the top of the display.

Note the bins and portions thereof shown in red. These are the paths that have negative slack; i.e., they do not meet the timing constraint. In this example you can see that some paths have failed but not by a large margin so it seems reasonable that with some work this design could be reworked to meet timing.

## Statistics

Clicking on the Statistics icon displays several design statistics, including the number of constraints, paths analyzed, and maximum frequency of the design.

## Trace Report

Clicking on the Trace icon shows the raw text report from the Trace program. This file gives considerable detail about the paths analyzed. Each path analyzed contains information

about every net and logic delay, clock skew, and clock uncertainty. The box at the bottom left of this display shows the path name of the timing report.

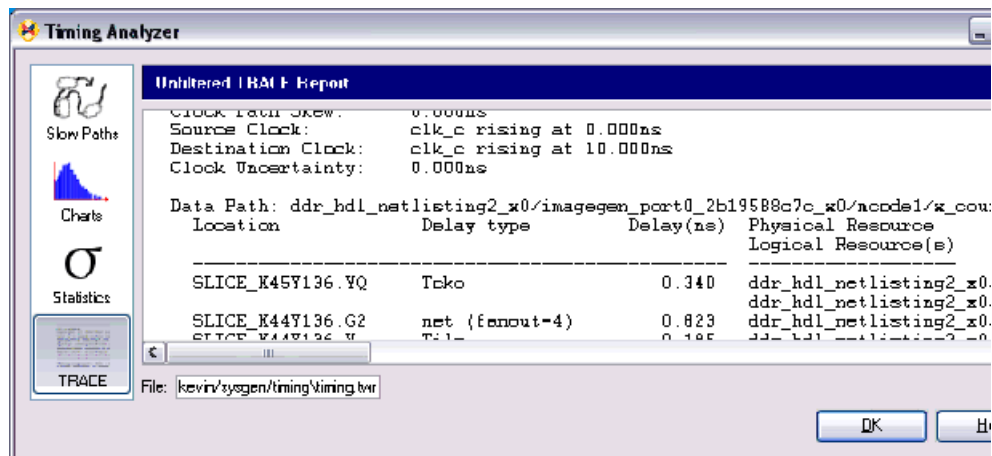

## Improving Failing Paths

"Now I have information about my failing paths; but what do I do now?" you may ask yourself. This is the trick for which there is no simple answer, and this is where you may need to delve into the lower-level aspects of FPGA design.

In general, steps that may be taken to meet timing are, in this order:

1. **Change the source design.** Just about any timing problem can be solved by changing the source design and this is the easiest way to speed up the circuit. Unfortunately, this is often the last step taken by designers, who often look for a quick solution such as using a faster part. The source design may be changed in several ways:
  - a. **Pipelining.** This is the surest way to improve speed, but may also be tricky. Adding pipelining registers increases latency. For designs with feedback, this may require great care since portions of the design may require pipeline rebalancing. See the later example for more details on pipelining.
  - b. **Parallelization.** This is probably the second most-important improvement you can make. Do you have a FIR filter that won't operate at the correct speed? You can use two FIR filters in parallel, each operating at half-rate, and interleave the outputs. This is the classic speed/area tradeoff.
  - c. **Retiming.** This involves taking existing registers and moving them to different points within the combinational logic to rob from Peter to pay Paul, so to speak. This works if, to stretch the maxim, Paul is bereft of slack, while Peter has a surfeit. Some synthesis tools can perform a degree of retiming automatically.
  - d. **Replication.** Replication of registers or buffers increases the amount of logic but reduces the fanout on the replicated objects. This decreases the capacitance of the net and reduces net delay. The replicated registers may also be floorplanned to place them closer to the logic groups they drive. Replication is often performed automatically by the tools and manual replication is not a common practice in a high-level design environment like System Generator.
  - e. **Shannon Expansion.** This method involves replicating the faster logic in a critical path in order to remove dependencies on slower logic. This is sometimes done automatically by the synthesizer.

- f. **Using Hard Cores.** Are you using a ROM that is implemented in distributed RAM when it would operate much faster in a block memory hard core? Do you have a wide adder that would benefit from being put in a DSP48 block, which can operate at 500MHz? Take advantage of the embedded hard cores.
  - g. **New Paradigms.** Do you need to create a large delay? Instead of using a counter with a long carry chain, why not build a delay out of cascaded Johnson rings using SRL16s? Or how about using an LFSR? Neither requires a carry chain and can operate much faster. Sometimes you have to rethink certain design elements completely.
2. **Eliminate overconstraints.** Ensure that elements of your design that only need to be operated at a subsampled rate are designed that way by using the downsample and upsample blocks in System Generator. If these blocks are not used, then the timing analyzer is not aware that these sections of the circuit are subsampled, and the design is overconstrained.
3. **Change the constraints.** Is it possible to run the design at a lower clock speed? If so, this is an easy way to meet your requirements. Unfortunately, this is rarely possible due to design requirements.
4. **Increase PAR effort levels.** The mapper and place & route tools (PAR) in ISE take effort levels as arguments. When using ISE (from the Project Navigator GUI), try the `-timing` option in MAP. You may also increase the PAR effort levels which will increase the PAR execution time but may also result in a faster design.
5. **Multipass PAR using SmartXplorer.** PAR is an iterative process and is somewhat chaotic in that the initial conditions can vastly influence the final result. SmartXplorer can be invoked from Project Navigator and allows you to run multiple implementation flows using different sets of implementation properties designed to optimize design performance.
6. **Floorplanning.** This step should be avoided if possible, but can yield huge improvements. The automatic placer in PAR can be improved upon by human intervention. Floorplanning places critical elements close to each other on the Xilinx die, reducing net delays. The PACE tool in ISE may be used for CPLD. A more advanced tool, PlanAhead™ software, is used for FPGA.
7. **Use a faster part.** This is often the first solution seized upon, but is also expensive. If you are using an old Xilinx part, porting your design to a newer, faster Xilinx part may often save money because the new parts may be cheaper on account of Moore's Law. However, moving to a faster part in the same family incurs significant extra costs, and often isn't necessary if the previous steps are followed.

## Creating Compilation Targets

The HDL and netlist files that System Generator produces when it compiles a design into hardware must be run through additional tools in order to produce a configuration bitstream file that is suitable for your FPGA. A typical flow that allows you to generate an FPGA configuration file is Project Navigator. There are other ways in which a bitstream can be generated for your model. For example, it is possible to configure System Generator to automatically run the tools necessary to produce a configuration file when it compiles a design. This is advantageous since the complete bitstream generation process is accomplished inside the tool. Moreover, you can have System Generator run different tools (e.g., ChipScope™ Pro Analyzer and iMPACT) once the configuration file is generated for a model.

The way in which System Generator compiles a model into hardware depends on the compilation target that is chosen for the design. The **HDL Netlist** compilation target is most common, and generates an HDL netlist of your design plus any cores that go along with it. New compilation targets can be created that extend the HDL Netlist target so that additional tools can be applied to the resulting HDL netlist files.

This topic explains how you can create new compilation targets that extend the HDL Netlist target in order to produce and configure FPGA hardware. More specifically, it describes how to configure System Generator to produce a bitstream for a model, and how to invoke various tools once the bitstream is created.

## Defining New Compilation Targets

You can create new compilation targets to run tools that process the output files associated with HDL Netlist compilation. A compilation target is defined by a minimum of two MATLAB functions. The first function, `xltarget.m`, tells System Generator to support the target (i.e., make it selectable from the System Generator token dialog box), and specifies the MATLAB function where more information about the target can be found. This function is called a "target info" function. A target info function defines information about the target, and can take any name, provided it is specified correctly in the target's `xltarget.m` function. In some cases, a target info function defines a post-generation function. A post-generation function is responsible for invoking tools or scripts after normal HDL netlist compilation is complete. These functions are discussed in more detail in the topics that follow.

### The xltarget Function

An `xltarget` function specifies one or more compilation targets that should be supported by System Generator. It also provides entry points through which System Generator can find out more information about these targets.

**Note:** System Generator determines which compilation targets to support by searching the plugins/compilation (and its subdirectories) of your System Generator software install tree for `xltarget.m` files.

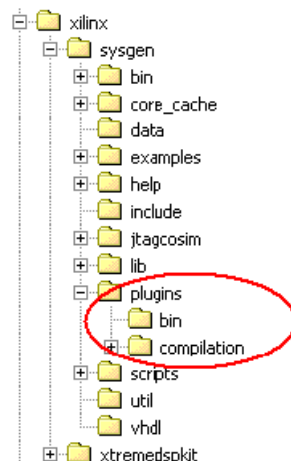

Although an `xltarget` function can specify multiple targets, it is not uncommon for each compilation target to have its own `xltarget` function. The directories these functions are saved in distinguish the targets. This means that each `xltarget.m` file must be saved in its own subdirectory under the `plugins/compilation` directory.

An `xltarget` function returns a cell array of target information. Different elements in this cell array define different compilation targets. The elements in this cell array are MATLAB structs that define two parameters:

1. The name of the compilation target as it should appear in the Compilation field of the System Generator parameters dialog box;
2. The name of the MATLAB function it should invoke to find out more information (e.g., System Generator dialog box parameters, which post-generation function to use, if any) about the target.

The following code shows how to define three compilation targets named Standalone Bitstream, iMPACT, and ChipScope™ Pro Analyzer:

```
function s = xltarget
s = {};
target_1('name') = 'Standalone Bitstream';
target_1('target_info') = 'xltools_target';
target_2('name') = 'iMPACT';
target_2('target_info') = 'xltools_target';
target_3('name') = 'ChipScope Pro Analyzer';
target_3('target_info') = 'xltools_target';
s = {target_1, target_2, target_3};
```

The name field in the code shown above specifies the name of the compilation target, as it should appear in the Compilation field of the System Generator dialog box:

```
target_1('name') = 'Standalone Bitstream';
```

The `target_info` field tells System Generator the target info function it should call to find out more information about the target. This function can have any name provided it is saved in the same directory as the corresponding `xltarget.m` file, or it is saved somewhere in the MATLAB path.

```
target_1('target_info') = 'xltools_target';
```

**Note:** An example `xltarget` function is included in the `examples/comp_targets` directory of your System Generator install tree. You can modify this function to define your own bitstream-related compilation targets.

## Target Info Functions

A target info function (specified by the `target_info` field in the code above) is responsible for two things:

- It defines the available and default settings for the target in the System Generator token dialog box;
- It specifies the functions System Generator should call before and after the standard code generation process.

**Note:** An example target info function, `xltools_target.m`, is included in the `examples/comp_targets` directory of your System Generator install tree.

One such function that is particularly useful to compilation targets is the post-generation function. A post-generation function is run after standard code generation. The code below shows how a post-generation function is specified in a target info function:

```
settings('postgeneration_fcn') = 'xltools_postgeneration';
```

## Post-generation Functions

One way to extend System Generator compilation is by defining a new variety of compilation that specifies a *post-generation function*. A post-generation function is a

MATLAB function that tells System Generator how to process the HDL and netlist files once they are generated. This function is run after System Generator finishes the normal code generation steps involved with HDL Netlist compilation (i.e., producing an HDL description of the design, running CORE Generator™, etc). For example, a hardware co-simulation target defines a post-generation function that in turn runs the tools necessary to produce hardware that can be used in the Simulink simulation loop.

**Note:** Two post-generation functions `xlBitstreamPostGeneration.m` and `xltools_postgeneration.m`, are included in the `examples/comp_targets` directory of your System Generator install tree.

### `xlBitstreamPostGeneration.m`

This example post-generation function compiles your model into a configuration bitstream that is appropriate for the settings (e.g., FPGA part, clock frequency, clock pin location) given in the System Generator dialog box of your design.

It then uses an XFLOW-based flow to invoke the Xilinx tools necessary to produce an FPGA configuration bitstream.

It is possible to configure the tools and configurations for each tool invoked by XFLOW. For more information on how to do this, refer to the topic in this example entitled [Using XFLOW](#)

### `xltools_postgeneration.m`

Sometimes you may want to run tools that configure and run the FPGA after a configuration bitstream has been generated (e.g., iMPACT, ChipScope™ Pro Analyzer). The `xltools_postgeneration` function first calls the `xlBitstreamGeneration` function to generate the bitstream. It then invokes the appropriate tool (or tools) depending on the compilation target that is selected.

For example, you may want a compilation target that invokes iMPACT after the bitstream is generated. This can be done as follows (assuming iMPACT is in your system path):

```
if (strcmp(params.compilation, 'iMPACT'))
    dos('impact');
end;
```

The first line checks the name of the compilation target. The second line sets up a DOS command that invokes iMPACT. ChipScope Pro Analyzer can be invoked similarly to the code above:

```
if (strcmp(params.compilation, 'ChipScope Pro Analyzer'))
    xlCallChipScopeAnalyzer;
end;
```

**Note:** `xlCallChipScopeAnalyzer` is a MATLAB function provided by System Generator to invoke ChipScope.

## Configuring and Installing the Compilation Target

Listed below are the steps necessary to configure and install new bitstream compilation targets.

1. Copy the `xltarget.m`, `xltools_postgeneration.m`, and `xltools_target.m` files from `examples/comp_targets` into a temporary directory.
2. Change the permissions of the above files so they can be modified.
3. Add the desired compilation targets (e.g., iMPACT, ChipScope Analyzer Pro) to the `xltarget.m` file.



4. Add the desired tool invocations to the `xltools_postgeneration.m` file.
5. Create a new directory (e.g., Bitstream) under the `plugins/compilation` directory of your System Generator software install tree. Copy the `xltarget.m`, `xltools_postgeneration.m`, and `xltools_target.m` files into this directory.

**Note:** The System Generator Compilation submenus mirror the directory structure under the `plugins/compilation` directory. When you create a new directory, or directory hierarchy, for the compilation target files, the names of the directories define the taxonomy of the compilation target submenus.

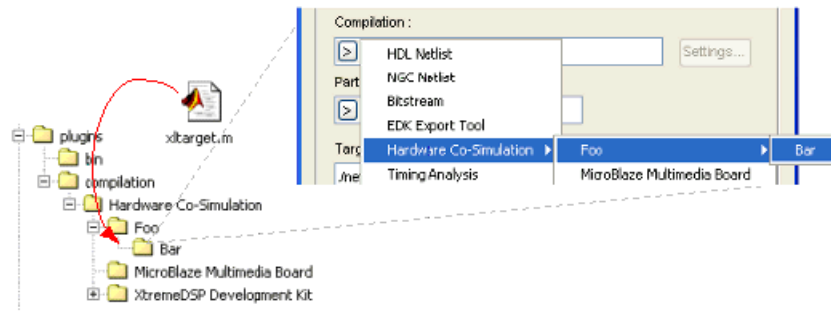

6. Copy the `xlBitstreamPostGeneration.m`, `xlToolsMakebit.pl`, `balanced_xltools.opt` and `bitgen_xltools.opt` files from the `examples/comp_targets` directory into a directory that is in your MATLAB path. These files must be in a common directory.
7. In the MATLAB command window, type the following:
 

```
>> rehash toolboxcache
>> xlrehash_xltarget_cache
```
8. You can now access the newly installed compilation target from the System Generator graphical interface.

## Using XFLOW

The post-generation scripting included with this example uses XFLOW to produce a configuration file for your FPGA. XFLOW allows you to automate the process of design synthesis, implementation, and simulation using a command line interface. XFLOW uses command files to tell it which tools to run, and how they should be run.

This example contains two XFLOW options files, `balanced_xltools.opt` and `bitgen_xltools.opt`. These files are associated with the implementation and configuration flows of XFLOW, respectively. The `balanced_xltools.opt` options files runs the Xilinx NGDBUILD, MAP, and PAR tools. The settings for each tool are specified in the options files. The `bitgen_xltools.opt` file runs BITGEN to produce a configuration file for your FPGA. You may modify these files as desired (e.g., to run the timing analyzer after PAR).



# Index

## A

- Addressable Shift Register block 13
- Algorithm Exploration 15
- ASR block 13
- Asynchronous Clocking 26
- Auto-Generated Clock Enable Logic
  - resetting in System Generator 105
- Automatic Code Generation 39
- AXI
  - Interface 151
  - signal Groups 24

## B

- Bit-Accurate 18
- Bitstream Compilation 399
- Bit-True Modeling 24
- Black Box
  - Configuration M-Function
    - adding new ports 342
    - black box API 350
    - black box clocking 345
    - combinational paths 346
    - configuring port sample rates 344
    - configuring port types 343
    - defining block ports 342
    - dynamic output ports 344
    - error checking 350
    - language selection 341
    - obtaining a port object 342
    - specifying the top-level entity 341
    - specifying Verilog parameters 346
    - specifying VHDL Generics 346
  - SysgenBlockDescriptor Member Variables 350
  - SysgenBlockDescriptor methods 351
  - SysgenPortDescriptor Member Variables 353
  - SysgenPortDescriptor methods 353
- Examples 357
  - advanced black box example using ModelSim 384
  - dynamic black boxes 380

- importing a Core Generator module 358
- importing a Core Generator module that needs a VHDL wrapper 364
- importing a Verilog module 378
- importing a VHDL module 371
- importing a Xilinx Core Generator module 357
- Importing an Encrypted VHDL File 389
- Importing, Simulating, and Exporting an Encrypted VHDL Module 389
- simulating several black boxes simultaneously 382
- HDL Co-Sim
  - configuring the HDL simulator 354
  - co-simulating multiple black boxes 356

- Black Box Configuration
  - M-function 340
- Black Box Configuration Wizard 339
- Block Masks 37
- Blockset
  - Xilinx 19

## C

- ChipScope Pro Analyzer 139
- Clock Domain Partitioning 128
- Clock Enable
  - Fanout Reduction 97
- Clock Frequency
  - selecting for Hardware Co-Sim 245
- Clocking
  - and timing 25
  - asynchronous 26
  - synchronous 27
- Clocking Options
  - Clock Enable 27
  - Expose Clock Ports 28
  - Hybrid DCM-CE 28, 42
- Code Generation
  - automatic 39
- Color Shading
  - blocks by signal rate 21
- Compilation Type
  - using XFLOW 420

- Compilation Types
  - Bitstream Compilation 399
  - configuring and installing the Compilation Target 419
  - creating new compilation targets 416
  - EDK Export Tool 403
  - Hardware Co-Simulation Compilation 407
  - HDL Netlist Compilation 398
  - NGC Netlist Compilation 398
- Compiling for
  - bitstream generation 399
  - EDK Export 403
  - Hardware Co-Simulation 407
  - NGC Netlist generation 398
- Compiling for HDL Netlist generation 398
- Compiling MATLAB
  - complex multiplier with latency 55
  - disp function 71
  - finite state machines 62
  - FIR example 66
  - into an FPGA 51
  - optional input ports 60
  - parameterizable accumulator 63
  - passing parameters into the MCode block 57
  - RPN calculator 69
  - shift operation 56
  - simple arithmetic operation 52
  - simple selector 51
- Compiling Shared Memories
  - for HW Co-Sim 257
- Configurable Subsystems and System Generator 88
- Configuring and Installing the Compilation Target 419
- Constraints File
  - System Generator 46
- Controls
  - hierarchical 44
- Creating Compilation Targets 416
- Crossing Clock Domains 129
- Custom Bus Interfaces
  - for exported pcore 404
- Cycle-Accurate 18
- Cycle-True Clock Islands 127
- Cycle-True Modeling 24

## D

DCM locked pin 42  
 DCM reset pin 42  
 Debugging  
   using ChipScope Pro 139  
 Defining New Compilation Targets 417  
   Target Info functions  
     xlttools\_target 418  
   the xltarget Function 417  
 Discrete Time Systems 25  
 Distinct Clocks  
   generating multiple cycle-true islands 127  
 DSP48  
   design styles for 108  
   design techniques 115  
   mapping from the DSP48 block 110  
   mapping standard components to 109  
   mapping to from logic synthesis tools 109  
   physical planning for 116  
 DSP48 Macro block 111

## E

EDK  
   generating software drivers 160  
   support from System Generator 175  
   writing a software program 163  
 EDK Export Tool 403  
   exporting a pc core 178  
 EDK Import Wizard 175  
 EDK Processor  
   exposing processor ports 177  
   importing 175  
 Encrypted VHDL File  
   how to import as a Black Box 389  
 Ethernet-based HW Co-Sim 307  
 Export pc core  
   enable Custom Bus Interfaces 404  
 Exporting  
   a pc core 178  
   a System Generator model as a pc core 159  
 Expose Clock Ports Option  
   tutorial 34

## F

Fanout Reduction  
   for Clock Enable 97

FDATool  
   using in digital filter applications 118

Floating-Point Data Type  
   signal Groups 21

FPGA  
   a brief introduction 10  
   generating a bitstream 102  
   notes for higher performance 94

Frame-Based Acceleration  
   using Hardware Co-Sim 268

Full Precision signal type 20

## G

Generating  
   an FPGA bitstream 102  
   EDK software drivers 160  
 Generating an FPGA Bitstream  
   Generating an FPGA Bitstream 102

## H

Hardware  
   oversampling 26  
 Hardware Co-Sim 239  
   blocks 242  
   choosing a compilation target 241  
   compiling shared memories 257  
   co-simulating lockable shared memories 260  
   co-simulating shared FIFOs 263  
   co-simulating shared registers 262  
   co-simulating unprotected shared memories 259  
   Installing Software on the Host PC 291  
   Installing the Proxy Executable for Linux Users 295  
   invoking the code generator 241  
   JTAG hardware requirements 323  
   Loading the Sysgen HW Co-Sim Configuration Files 293  
   Network-Based Ethernet 253  
   Point-to-Point Ethernet 249  
   processor integration 159  
   restrictions on shared memories 266  
   selecting the target clock frequency 245  
   Setting Up the Local Area Network on the PC 291  
   shared memory support 256  
   using for frame-based acceleration 268

  using for real-time signal processing 281

  Xilinx tool flow settings 266

Hardware Co-Simulation Compilation 407

Hardware Debugging  
   using ChipScope Pro 139

Hardware Generation 159

Hardware Generation Mode  
   EDK pc core 159  
   HDL netlist 159

Hardware/Software Co-Design 156

  Examples

    creating a MicroBlaze Peripheral in System Generator 185

    designing and simulating MicroBlaze Processor Systems 192

    using EDK 200

    using PicoBlaze in System Generator 180

HDL Co-Sim

  configuring the HDL simulator 354

  co-simulating multiple black boxes 356

HDL Netlist Compilation 398

HDL Testbench 50

Hierarchical Controls 44

Histogram Charts

  from Timing Analyzer 412, 415

Hybrid DCM-CE Option

  locked pin 28

  reset pin 28

  tutorial 29

## I

Implementing

  a complete design 16

  part of a design 15

Importing

  a System Generator design 73

  A System Generator Design into PlanAhead 86

  an EDK processor 175

  an EDK project 159

Importing a System Generator Design 73

  integration design rules 73

  integration flow with Project Navigator 74

  step-by-step example 75

Installation

  Installing a KC705 Board for JTAG Hardware Co-Sim 321

Installing a Spartan-3A DSP 1800A Starter Board for Hardware Co-Sim 307

Installing an ML402 Board for JTAG Hardware Co-Sim 315

Installing an ML605 Board for JTAG Hardware Co-Sim 317

Installing an SP601/SP605 Board for Ethernet Hardware Co-Sim 313

Installing an SP601/SP605 Board for JTAG Hardware Co-Sim 319

Introduction to FPGAs 10

## J

JTAG Hardware Co-Sim

- board support package files 329
- Detecting New Board Packages 335
- installing board-support packages 334
- manually specifying board-specific ports 332
- obtaining platform information 330
- providing your own top-level 333
- supporting new boards 323

JTAG-based HW Co-Sim 313, 315, 317, 319, 321

## K

KC705 Board

- Installation for JTAG HW Co-Sim 321

## L

Linux

- Installing the Proxy Executable for Linux Users 295

Locked pin

- Hybrid DCM-CE Option 28

## M

MATLAB

- compiling into an FPGA 51
- complex multiplier with latency 55
- disp function 71
- finite state machines 62
- FIR example 66
- optional input ports 60
- parameterizable accumulator 63

- passing parameters into the MCode block 57
- RPN calculator 69
- simple arithmetic operation 52
- simple selector 51
- simple shift operation 56

Memory Map Creation

- for processor integration 158

M-Function

- black box configuration 340

MicroBlaze

- in System Generator tutorial 185
- System Design and Simulation 192

ML402 Board

- Installation for JTAG HW Co-Sim 315

ML605 Board

- Installation for JTAG HW Co-Sim 317

Modeling

- bit-true and cycle-true 24

Multiple Clock Applications 127

Multirate Designs

- color shading by signal rate 21

Multirate Models 25

## N

Netlisting

- multiple clock designs 130

Network-Based Ethernet Hardware Co-Sim 253

NGC Netlist Compilation 398

Notes

- for higher performance FPGA design 94

## O

OutputFiles

- produced by System Generator 44

Oversampling 26

## P

Parameter Passing 38

Pcore

- export as under development 403

pcore

- exporting 178
- exporting a System Generator model as a peripheral 159

PicoBlaze

- designing within System Generator 178
- in System Generator tutorial 180
- overview 178

PlanAhead

- generating a PPR file from System Generator 82
- Importing a System Generator Design 86

PLB-based pcore 156

Point-to-Point Ethernet HW Co-Sim 249

Power Analysis

- using XPower 407

Processor Integration

- Hardware Co-Sim 159
- hardware generation 159
- memory map creation 158
- using custom logic 156

Project File

- Generating a PlanAhead project file from System Generator 82

Project Navigator

- integration flow with System Generator 74

## R

Rate-Changing Blocks 26

Real-Time Signal Processing

- using Hardware Co-Sim 281

Reducing

- Clock Enable Fannout 97

Reference Blockset

- Xilinx 19

Reset pin

- Hybrid DCM-CE Option 28

Resource Estimation 39

## S

SBD Builder

- saving plugin files 328
- specifying board-specific I/O ports 326

SDK Standalone

- Migrating a software project from XPS 207

Shared Memory Support

- for HW Co-Sim 256

Signal Groups

- AXI 24
- Floating-Point Data Type 21

Signal Types 20

- displaying data types 21
- full precision 20
- gateway blocks 20
- user-specified precision 20
- Simulink System Period 43
- Software Project
  - migrating from XPS to SDK 207
- SP601/SP605 Board
  - Installation for Ethernet Hardware C-Sim Co-Sim 313
  - Installation for JTAG Hardware Co-Sim 319
- Spartan-3A DSP 1800A Starter Board
  - Installation for Ethernet HW Co-Sim 307
- Synchronization Mechanisms
  - indeterminate data 37
  - valid ports 37
- Synchronous Clocking 27
  - Clock Enable option 27
  - Expose Clock Ports option 28
  - Hybrid DCM-CE option 28, 42
- System Generator
  - adding a block to a Configurable Subsystem 91
  - and Configurable Subsystems 88
  - blocksets 18
  - defining a Configurable Subsystem 88
  - deleting a block from a Configurable Subsystem 91
  - generating hardware from Configurable Subsystems 92
  - output files 44
  - processing a design with physical design tools 99
  - resetting auto-generated Clock Enable logic 105
  - system-level modeling 17
  - using a Configurable Subsystem 90
- System Generator Constraints
  - constraints file 46
  - example 47
  - IOB timing and placement 46
  - multicycle path 46
  - system clock period 46
- System Generator Design Flows
  - algorithm exploration 15
  - implementing a complete design 16
  - implementing part of a larger design 15
- System Generator token
  - compiling and simulating 40
- System-Level Modeling 17

## T

- Tapped Delay Lines 13
- TDM data streams 13
- Testbench
  - HDL 50
- Time-Division Multiplexed 13
- Timing Analysis
  - clock skew and jitter 410
  - concepts review 409
  - cross-probing 411
  - displaying low-level names 411
  - histogram charts 412, 415
  - improving failing paths 415
  - observing slow paths 410
  - path analysis example 409
  - period and slack 409
  - statistics 414
  - trace report 414
- Timing Analyzer
  - invoking on previously-generated data 408
- Timing and Clocking 25
- Timing and Power Analysis
  - compilation type
    - Compiling for timing and power analysis 407
- Trace Report
  - timing analysis 414
- Tutorials
  - Black Box
    - Dynamic Black Boxes 380
    - Importing a Core Generator Module 358
    - Importing a Core Generator Module that Needs a VHDL Wrapper 364
    - Importing a Verilog Module 379
    - Importing a VHDL Module 371
    - Importing, Simulating, and Exporting an Encrypted VHDL Module 389
    - Simulating Several Black Boxes Simultaneously 382
  - ChipScope
    - Using ChipScope in System Generator 139
  - Clocking
    - Using the Clock Generator(DCM) Option 29
    - Using the Expose Clock Ports Option 34

- Hardware/Software Co-Design
  - Creating a MicroBlaze Peripheral in System Generator 185
  - Creating a New XPS Project 200
  - Designing and Simulating MicroBlaze Processor Systems 192
  - Using PicoBlaze in System Generator 180
- Using System Generator and SDK to Co-Debug an Embedded DSP Design 214

## U

- Underdevelopment
  - export pcore as 403
- Using XFLOW 420

## V

- Variable Clock Frequency
  - selecting for Hardware Co-Sim 245

## W

- Wizards
  - Base System Builder 200
  - Black Box Configuration 339, 371
  - EDK Import 175
  - XPS Import 194

## X

- Xilinx
  - Blockset 19
  - Reference Blockset 19
- Xilinx Tool Flow Settings
  - for HW Co-Sim 266
- xlCallChipScopeAnalyzer 419
- xlmax 51
- xlSimpleArith 52
- xltarget
  - defining new Compilation Targets 417
- xlTimingAnalysis 408
- xltools\_postgeneration 418, 419
- xltools\_target 418
- XPower
  - power analysis 407
- XPS Import Wizard 194