

# **Vivado Design Suite Tutorial**

## ***Partial Reconfiguration***

UG947 (v2017.1) April 5, 2017



---

## Revision History

The following table shows the revision history for this document.

Date	Version	Changes
04/05/2017	2017.1	Updated content based on the new Vivado IDE look and feel. Updated Steps 4, 5, and 6 in Lab 1 and Lab 2. Added Lab 4: Vivado Debug and the PR Project Flow. Previous Lab 4 and Lab 5 changed to Lab 5 and Lab 6, respectively.

# Table of Contents

Revision History.....	2
Introduction .....	5
Overview .....	5
Hardware and Software Requirements .....	6
Tutorial Design Description .....	6
Lab 1: 7 Series Basic Partial Reconfiguration Flow .....	8
Step 1: Extracting the Tutorial Design Files .....	8
Step 2: Examining the Scripts.....	8
Step 3: Synthesizing the Design.....	10
Step 4: Assembling and Implementing the Design .....	10
Step 5: Building the Design Floorplan .....	12
Step 6: Implementing the First Configuration .....	18
Step 7: Implementing the Second Configuration.....	23
Step 8: Examining the Results with Highlighting Scripts.....	25
Step 9: Generating Bitstreams .....	26
Step 10: Partially Reconfiguring the FPGA.....	28
Conclusion.....	29
Lab 2: UltraScale Basic Partial Reconfiguration Flow .....	30
Step 1: Extracting the Tutorial Design Files .....	30
Step 2: Examining the Scripts.....	30
Step 3: Synthesizing the Design.....	32
Step 4: Assembling and Implementing the Design .....	32
Step 5: Building the Design Floorplan .....	34
Step 6: Implementing the First Configuration .....	38
Step 7: Implementing the Second Configuration.....	44
Step 8: Examining the Results with Highlighting Scripts.....	46
Step 9: Generating the Bitstreams .....	48
Step 10: Partially Reconfiguring the FPGA.....	51

Conclusion.....	52
Lab 3: Partial Reconfiguration Project Flow .....	53
Section 1 – Setting up the Partial Reconfiguration design structure.....	53
Section 2 – Managing Design Runs.....	61
Section 3 – Iterating on a Partial Reconfiguration design .....	65
Lab 4: Vivado Debug and the PR Project Flow.....	73
Overview .....	73
Section 1 – Set up the Partial Reconfiguration design.....	73
Section 2 – Managing Design Runs.....	85
Section 3 – Debugging the Partial Reconfiguration design.....	97
Lab 5: Partial Reconfiguration Controller IP for 7 Series Devices .....	104
Step 1: Extracting the Tutorial Design Files .....	104
Step 2: Customizing the Partial Reconfiguration Controller IP .....	104
Step 3: Compiling the Design .....	111
Step 4: Setting up the Board.....	112
Step 5: Operating the Sample Design .....	113
Step 6: Querying the PRC in the FPGA.....	115
Step 7: Modifying the PRC in the FPGA.....	117
Conclusion.....	119
Lab 6: Partial Reconfiguration Controller IP for UltraScale Devices.....	120
Step 1: Extracting the Tutorial Design Files .....	120
Step 2: Customizing the Partial Reconfiguration Controller IP .....	120
Step 3: Compiling the Design .....	127
Step 4: Setting up the Board.....	128
Step 5: Operating the Sample Design .....	128
Step 6: Querying the PRC in the FPGA.....	129
Step 7: Modifying the PRC in the FPGA.....	131
Conclusion.....	133
Legal Notices .....	134
Please Read: Important Legal Notices.....	134

---

## Overview

This tutorial covers the Partial Reconfiguration (PR) software support in Vivado® Design Suite release 2017.1.

Lab 1: 7 Series Basic Partial Reconfiguration Flow and Lab 2: UltraScale Basic Partial Reconfiguration Flow step through basic information about the current Partial Reconfiguration (PR) design flow, example Tcl scripts, and show results within the Vivado integrated design environment (IDE). You run scripts for part of the lab and work interactively with the design for other parts. You can also script the entire flow, and a completed script is included with the design files. These labs focus specifically on the software flow from RTL to bitstream, demonstrating how to process a Partial Reconfiguration design. Lab 2 also applies to UltraScale+ devices.

Lab 3: Partial Reconfiguration Project Flow steps you through the project flow within the Vivado IDE, from establishing the design using the Partial Reconfiguration Wizard to synthesis, iteration runs, and then iterating the design. Lab 4: Vivado Debug and the PR Project Flow also walks you through the project flow, but includes adding IP, debug cores, and debugging through the Vivado Hardware Manager.

Lab 5: Partial Reconfiguration Controller IP for 7 Series Devices and Lab 6: Partial Reconfiguration Controller IP for UltraScale Devices are designed to show the fundamental details and capabilities of the Partial Reconfiguration Controller (PRC) IP in the Vivado Design Suite. Managing partial bitstreams is one of the new design requirements introduced by PR: designers plan for when partial bitstreams are required, where they are stored, how they are delivered to the configuration engine, and how the static design behaves before, during and after the delivery of a new partial bitstream. The PRC IP is designed to help users solve these challenges.

## Additional Resources

For additional information, please see these documents:

- *Vivado Design Suite User Guide: Partial Reconfiguration* ([UG909](#))
- *Partial Reconfiguration Controller Product Guide* ([PG193](#))
- DocNav includes a Partial Reconfiguration Design Hub that links these documents and other PR-specific resources. It is also available through the [Xilinx support site](#).

---

**VIDEO:**

The following videos provide an overview of Vivado Partial Reconfiguration solutions:



- [Vivado Design Suite QuickTake Video Tutorial: Partial Reconfiguration in Vivado](#)
- [Vivado Design Suite QuickTake Video Tutorial: Partial Reconfiguration for UltraScale](#)
- [Vivado Design Suite QuickTake Video Tutorials](#)

---

**TRAINING:** Xilinx provides training courses that can help you learn more about the concepts presented in this document. Use the link to explore related courses:

- [Xilinx Partial Reconfiguration Tools & Techniques](#)
  - [Partial Reconfiguration Flow on Zynq using Vivado](#)
- 

---

## Hardware and Software Requirements

This tutorial requires that the 2017.1 Vivado Design Suite software release or later is installed. A Partial Reconfiguration license is required to run the PR software tools in the Vivado Design Suite. If necessary, request access by sending an email to [pr\\_access@xilinx.com](mailto:pr_access@xilinx.com) for a 30-day evaluation license. A valid corporate or university email address is required.

For Operating Systems support, see the *Vivado Design Suite User Guide: Release Notes, Installation, and Licensing (UG973)* for a complete list and description of the system and software requirements.

---

## Tutorial Design Description

Designs for the tutorial labs are available as a zipped archive on the Xilinx website. Each lab in this tutorial has its own folder within the zip file. To access the tutorial design files:

1. Download the [Reference Design Files](#) from the Xilinx website.
2. Extract the zip file contents to any write-accessible location.

### **Lab 1: 7 Series Basic Partial Reconfiguration Flow**

The sample design used throughout this tutorial is called `led_shift_count_7s`. The design targets the following Xilinx development platforms:

- KC705 (xc7k325t), Rev 1.0 or 1.1
- VC707 (xc7vx485t)
- VC709 (xc7vx690t)
- AC701 (xc7a200t)

This design is very small, which (1) helps minimize data size and (2) allows you to run the tutorial quickly, with minimal hardware requirements.

### ***Lab 2: UltraScale Basic Partial Reconfiguration Flow***

The sample design used throughout this tutorial is called `led_shift_count_us`. The design targets the following Xilinx development platforms:

- KCU105 (xc7k040), Rev 1.0
- VCU108 (xcvu095), Rev 1.0

### ***Lab 3: Partial Reconfiguration Project Flow***

The sample design used throughout this tutorial is called `pr_project`. It is a modified version of the `led_shift_count` design used in Lab 1, modified to include two shift instances instead of one counter and one shifter. This change helps illustrate that a Partition Definition applies to all instances of a partition type. The design targets the following Xilinx development platforms:

- KC705 (xc7k325t)
- VC707 (xc7vx485t)
- VC709 (xc7vx690t)
- KCU105 (xc7k040)
- VCU108 (xcvu095)

### ***Lab 4: Vivado Debug and the PR Project Flow***

The sample design used is called `pr_project_debug`. The design targets the KCU105 Xilinx development platform.

### ***Lab 5: Partial Reconfiguration Controller IP for 7 Series Devices***

The sample design used throughout this tutorial is called `prc_7s` and is based on the design used in Lab 1. The design targets the following Xilinx development platforms:

- KC705 (xc7k325t), Rev 1.0 or 1.1
- VC707 (xc7vx485t)
- VC709 (xc7vx690t)

### ***Lab 6: Partial Reconfiguration Controller IP for UltraScale Devices***

The sample design used throughout this tutorial is called `prc_us`. The design targets an xcvu095 device for use on the VCU108 demonstration board, Rev 1.0, and is based on the design used in Lab 2.

## Lab 1: 7 Series Basic Partial Reconfiguration Flow

---

### Step 1: Extracting the Tutorial Design Files

1. To obtain the tutorial design file, see Tutorial Design Description.
  2. Navigate to `\led_shift_count_7s` in the extracted files. The `led_shift_count_7s` data directory is referred to in this lab as the `<Extract_Dir>`.
- 

### Step 2: Examining the Scripts

Start by reviewing the scripts provided in the design archive. The files `design.tcl` and `design_complete.tcl` are located at the root level. Both files contain the same information, but `design.tcl` has parameters set such that only synthesis runs, while `design_complete.tcl` runs the entire flow for two configurations.

#### The Main Script

In the `<Extract_Dir>`, open `design.tcl` in a text editor. This is the master script where you define the design parameters, design sources, and design structure. This is the only file you have to modify to compile a complete Partial Reconfiguration design. Find more details regarding `design.tcl` and the underlying scripts in the `README.txt` located in the `Tcl_HD` subdirectory.

Note the following details in this file:

- Under **Define target demo board**, you can select one of many demonstration boards supported for this design. To select one, uncomment the single desired board.
- Under **flow control**, you can control what phases of synthesis and implementation are run. In the tutorial, only synthesis is run by the script; implementation, verification, and bitstream generation are run interactively. To run these additional steps via the script, set the flow variables (e.g., `run.prImpl`) to **1**.
- The **Output Directories** and **Input Directories** set the file structure expected for design sources and results files. You must reflect any changes to your file structure here.



- The **Top Definition** and **RP Module Definitions** sections allow you to reference all source files for each part of your design. Top Definition covers all sources needed for the static design, including constraints and IP. The RP Module Definitions section does the same for Reconfigurable Partitions (RP). Complete a section for each RP and list all Reconfigurable Module (RM) variants for each RP.
  - This design has two Reconfigurable Partitions (`inst_shift` and `inst_count`), and each RP has two module variants.
- The **Configuration Definition** sections define the sets of static and reconfigurable modules that make up a configuration.
  - This design has two configurations, `Config_shift_right_count_up_implement` and `Config_shift_left_count_down_import`. You can create more configurations by adding RMs or by combining existing RMs.

## The Supporting Scripts

Underneath the `Tcl_HD` subdirectory, several supporting Tcl scripts exist. The scripts are called by `design.tcl`, and they manage specific details for the Partial Reconfiguration flow. Provided below are some details about a few of the key PR scripts.



---

**CAUTION!** Do not modify the supporting Tcl scripts.

---

- `step.tcl`  
Manages the current status of the design by monitoring checkpoints.
- `synthesize.tcl`  
Manages the details regarding the synthesis phase.
- `implement.tcl`  
Manages the details regarding the module implementation phase.
- `pr_utils.tcl`  
Manages the details regarding the top-level implementation of a PR design.
- `run.tcl`  
Launches the actual runs for synthesis and implementation.
- `log_utils.tcl`  
Handles report file creation at key points during the flow.

Remaining scripts provide details within these scripts (such as other `*_utils.tcl` scripts) or manage other Hierarchical Design flows (such as `hd_utils.tcl`).

---

## Step 3: Synthesizing the Design

The `design.tcl` script automates the synthesis phase of this tutorial. Five iterations of synthesis are called, one for the static top-level design and one for each of four Reconfigurable Modules.

1. Open the Vivado Tcl shell:
  - On Windows, select the Xilinx Vivado desktop icon or **Start > All Programs > Xilinx Design Tools > Vivado 2017.x > Vivado 2017.x Tcl Shell**.
  - On Linux, simply type, `vivado -mode tcl`.
2. In the shell, navigate to the `<Extract_Dir>` directory.
3. If you are using a target demonstration board other than the KC705, modify the `xboard` variable in `design.tcl`. Valid alternatives are the VC707, VC709 and AC701 boards.
4. Run the `design.tcl` script by entering:

```
source design.tcl -notrace
```

After all five passes through Vivado Synthesis have completed, the Vivado Tcl shell remains open. You can find log and report files for each module, alongside the final checkpoints, under each named folder in the `Synth` subdirectory.

---

**TIP:** In the `<Extract_Dir>` directory, multiple log files have been created:

- `run.log` shows the summary as posted in the Tcl shell window
  - `command.log` echoes all the individual steps run by the script
  - `critical.log` reports all critical warnings produced during the run
- 



---

## Step 4: Assembling and Implementing the Design

Now that the synthesized checkpoints for each module, plus top, are available, you can assemble the design. Because project support for Partial Reconfiguration flows is not yet in place, you do not use the project infrastructure from within the IDE.

You will run all flow steps from the Tcl Console, but you can use features within the IDE (such as the floorplanning tool) for interactive events.

---

**TIP:** Copy and paste commands directly from the tutorial to avoid redundant effort and typos in the Vivado IDE. Copy and paste only one full command at a time. Note that some commands are long and span multiple lines.

---



1. Open the Vivado IDE. You can open the IDE from the open Tcl shell by typing `start_gui` or by launching Vivado with the command `vivado -mode gui`.
2. Navigate to the `<Extract_Dir>` directory if you are not already there. The `pwd` command can confirm this.
3. Create an in-memory design by issuing the following command in the Tcl Console:  
`create_project -in_memory -part <part>`

`<part>` (here and later on) is one of the four target devices supported by this lab:

- o `xc7k325tffg900-2`
- o `xc7vx485tffg1761-2`
- o `xc7vx690tffg1761-2`
- o `xc7a200tfbg676-2`

4. Load the static design by issuing the following command:

```
add_files ./Synth/Static/top_synth.dcp
```

5. Load the top-level design constraints by issuing these commands:

```
add_files ./Sources/xdc/top_io_<board>.xdc
```

```
set_property USED_IN {implementation} [get_files  
./Sources/xdc/top_io_<board>.xdc]
```

`<board>` (here and later on) is one of the four target platforms supported by this lab:

- o `kc705`
- o `vc707`
- o `vc709`
- o `ac701`

Selecting the `top_io_<board>` version of the available xdc file loads the pin location and clocking constraints, but does not include floorplan information. The `top_<board>` version includes pin location, clocking and floorplanning constraints.

6. Load the first two synthesis checkpoints for the shift and count functions by issuing these commands:

```
add_file ./Synth/shift_right/shift_synth.dcp
```

```
set_property SCOPED_TO_CELLS {inst_shift} [get_files  
./Synth/shift_right/shift_synth.dcp]
```

```
add_file ./Synth/count_up/count_synth.dcp
```

```
set_property SCOPED_TO_CELLS {inst_count} [get_files  
./Synth/count_up/count_synth.dcp]
```

The `SCOPED_TO_CELLS` property ensures that the proper assignment is made to the target cell. See this [link](#) in *Vivado Design Suite User Guide: Using Constraints (UG903)* for more information.

7. Link the entire design together using the `link_design` command:

```
link_design -mode default -reconfig_partitions {inst_shift inst_count}
-part <part> -top top
```

At this point a full configuration is loaded, including static and reconfigurable logic. Note that the Flow Navigator pane is not present while you are working in non-project mode.



**TIP:** Place the IDE in floorplanning mode by selecting **Layout > Floorplanning**. Make sure the Device view is visible.

8. Define each of these submodules as partially reconfigurable by setting the `HD.RECONFIGURABLE` property:

```
set_property HD.RECONFIGURABLE 1 [get_cells inst_shift]
set_property HD.RECONFIGURABLE 1 [get_cells inst_count]
```

9. Save the assembled design state for this initial configuration:

```
write_checkpoint -force./Checkpoint/top_link_right_up.dcp
```

---

## Step 5: Building the Design Floorplan

Next, create a floorplan to define the regions that will be partially reconfigured.

1. Select the `inst_count` instance in the Netlist pane. Right-click and select **Floorplanning > Draw Pblock**, or select the **Draw Pblock** toolbar button , and draw a tall narrow box on the left side of the X0Y3 clock region. The exact size and shape do not matter at this point, but keep the box within the clock region.

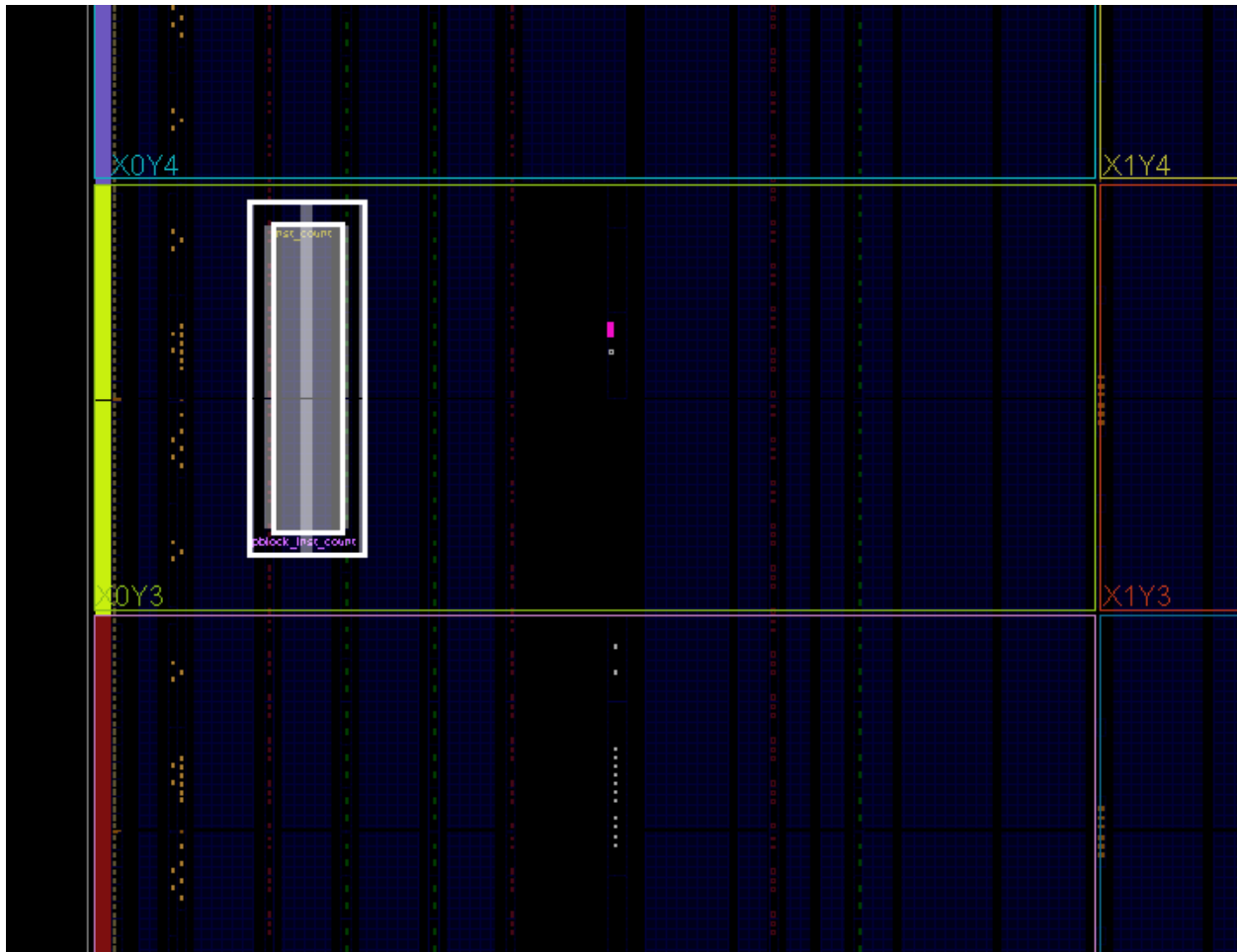

**Figure 1: Pblock for the inst\_count Reconfigurable Partition**

Although this Reconfigurable Module only requires CLB resources, also include RAMB16, RAMB32, or DSP48 resources if the box encompasses those types. This allows the routing resources for these block types to be included in the reconfigurable region. The **General** tab of the Pblock Properties pane can be used to add these if needed. The **Statistics** tab shows the resource requirements of the currently loaded Reconfigurable Module.

2. In the Properties pane, select the checkbox for **RESET\_AFTER\_RECONFIG** to utilize the dedicated initialization of the logic in this module after reconfiguration completes.
3. Repeat steps 1 and 2 for the `inst_shift` instance, this time targeting the right side of clock region X1Y1. This Reconfigurable Module includes block RAM instances, so the resource type must be included. If omitted, the RAMB details in the **Statistics** tab are shown in red.

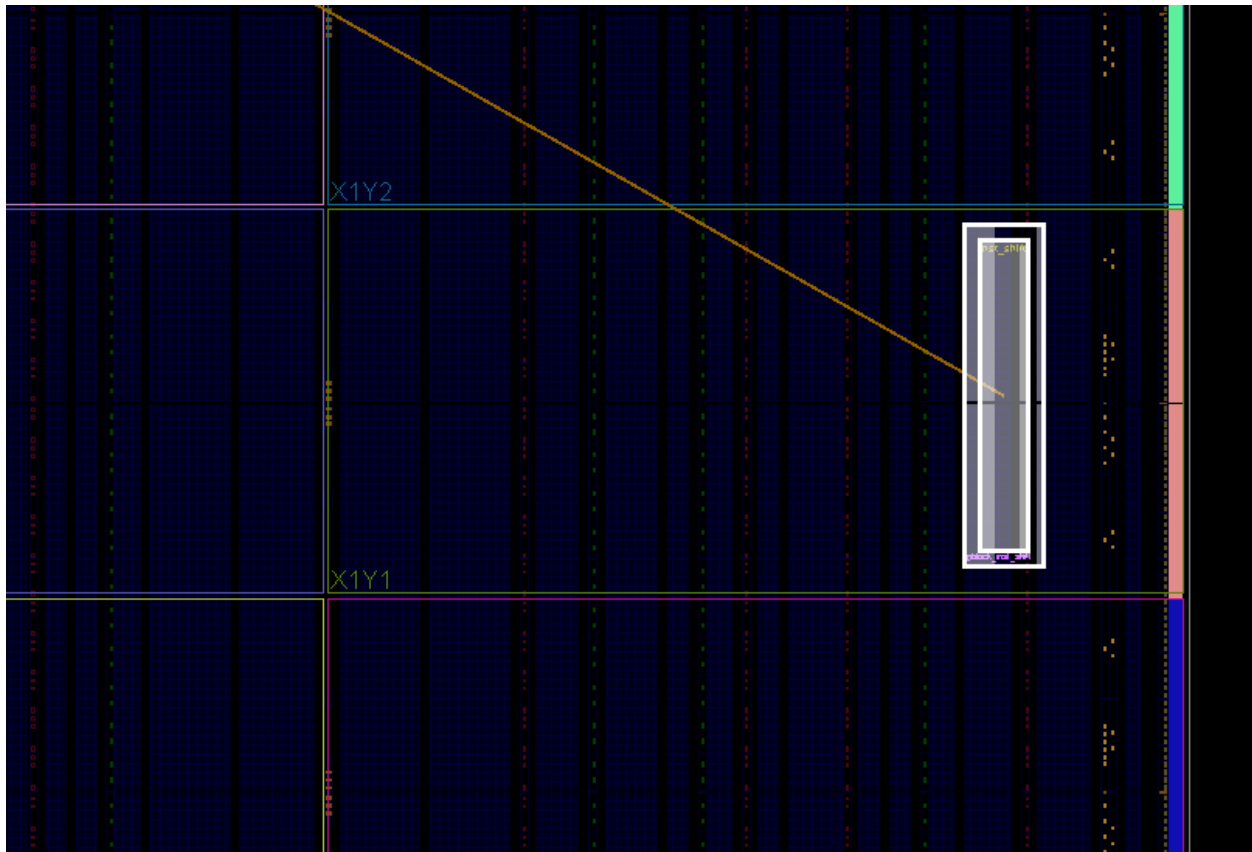

**Figure 2: Pblock for the inst\_shift Reconfigurable Partition**

4. Run Partial Reconfiguration Design Rule Checks by selecting **Tools > Report > Report DRC**. You can uncheck **All Rules** and then check **Partial Reconfiguration** to focus this report strictly on PR DRCs.

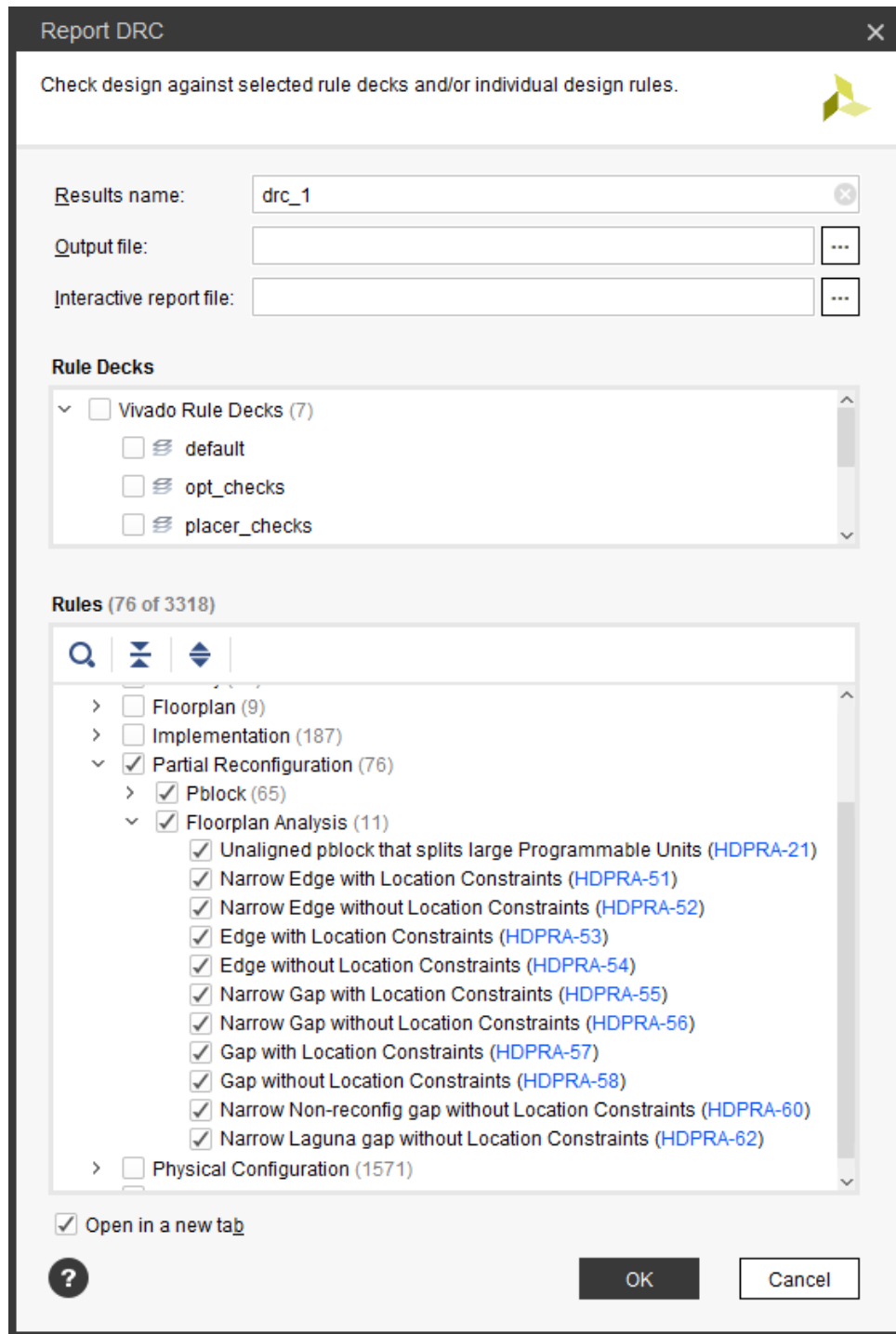
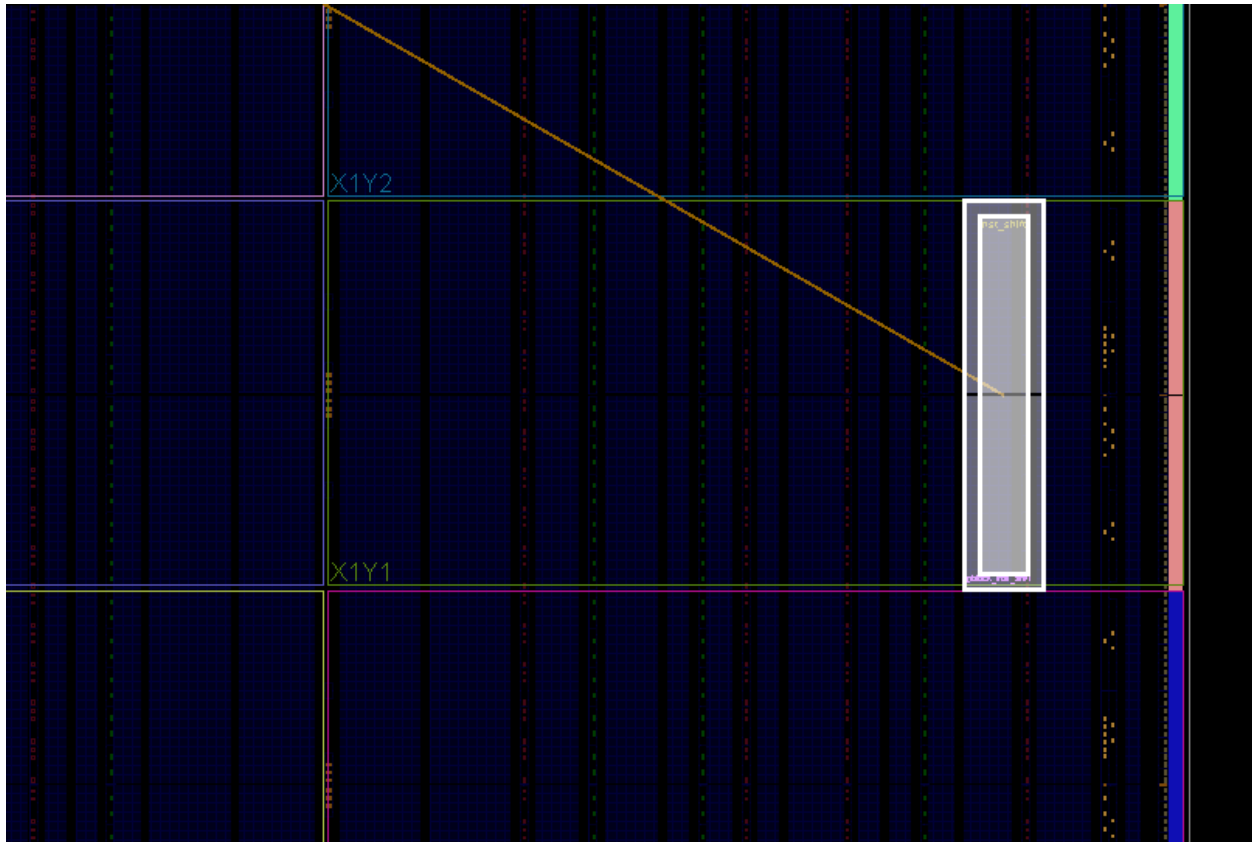

**Figure 3: Partial Reconfiguration Design Rule Checks (DRCs)**

One or two DRCs are reported at this point, and there are two ways of resolving them. For this lab, you will use one method for `inst_shift` and the other for `inst_count`.

The first DRC is an error, HDPR-10, reporting that `RESET_AFTER_RECONFIG` requires Pblock frame alignment.

- To resolve the first DRC error, make sure that the height of the Pblock aligns with the clock region boundaries. Using the Pblock for `inst_shift`, stretch the top and bottom edges to match the clock region boundaries of X1Y1 as shown in the figure below. See that the shading of the Pblock is now more uniform.

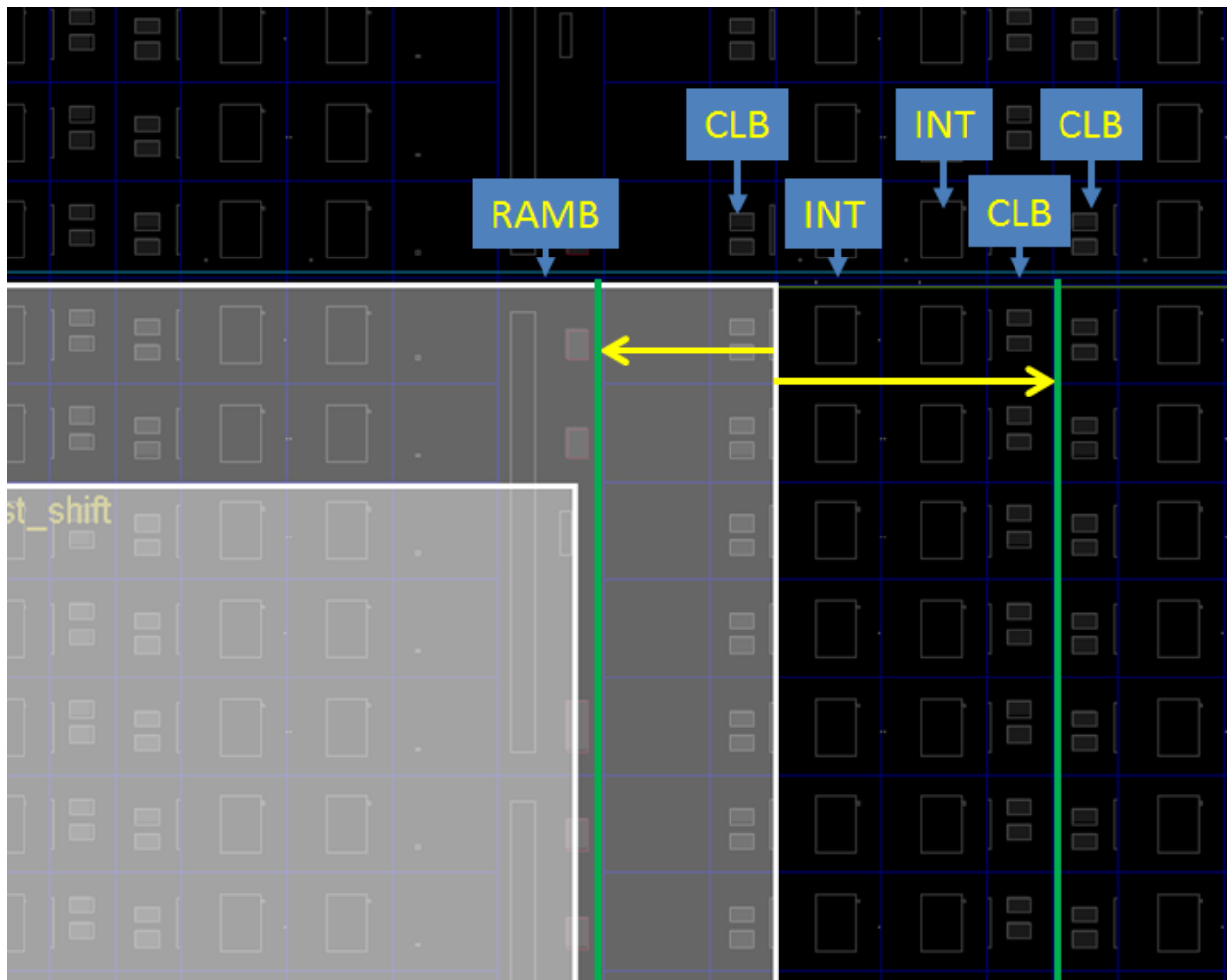

**Figure 4: Pblock for the aligned `inst_shift` Reconfigurable Partition**

The other possible DRC is a warning, HDPR-26, reporting that a left or right edge of a reconfigurable Pblock terminates on an improper boundary. Left or right edges must not split interconnect (INT) columns. More information on this requirement can be found in the *Vivado Design Suite User Guide: Partial Reconfiguration* ([UG909](#)), in the section entitled Reconfigurable Partition Pblock Sizes and Shapes.

- To manually avoid this DRC warning, zoom into the upper or lower corner on the reported edge of `inst_shift` (or `inst_count`, if `inst_shift` did not report an issue) to see where the violation occurred. Move this edge left or right one column, as shown by the yellow arrows in [Figure 5](#), so it lands between two resource types (CLB-CLB or CLB-RAMB, for example) instead landing between CLB-INT or BRAM-INT.





**Figure 5: Adjusting the Edges of a Reconfigurable Pblock**

7. Run the PR DRCs again to confirm that the errors and warnings that you have addressed have been resolved for the `inst_shift` instance.

An alternative to manually adjusting the size and shape of reconfigurable Pblocks is to use the `SNAPPING_MODE` feature. This feature automatically adjusts edges to align with legal boundaries. It will make the Pblock taller, aligning with clock region boundaries, if the `RESET_AFTER_RECONFIG` feature is selected. It makes the Pblock narrower, adjusting left and/or right edges as needed. Note that the number and type of resources available are altered if `SNAPPING_MODE` makes changes to the Pblock.

8. Select the Pblock for `inst_count`, and in the **Properties** tab of the Pblock Properties pane, change the value of `SNAPPING_MODE` from OFF to ROUTING (or ON).

Note that the original Pblock does not change. The adjustments to the Pblock needed for it to conform to PR rules are done automatically, without modifying your source constraints.

9. Run the PR DRCs once again to confirm that all issues have been resolved.

10. Save these Pblocks and associated properties:

```
write_xdc ./Sources/xdc/top_all.xdc
```

This exports all the current constraints in the design, including those imported earlier from `top_io_<board>.xdc`. These constraints can be managed in their own XDC file or managed within a run script (as is typically done with `HD.RECONFIGURABLE`).

Alternatively, the Pblock constraints themselves can be extracted and managed separately. A Tcl proc is available to help perform this task.

a. First source the proc which is found in one of the Tcl utility files:

```
source ./Tcl_HD/hd_utils.tcl
```

b. Then use the `export_pblocks` proc to write out this constraint information:

```
export_pblocks -file ./Sources/xdc/pblocks.xdc
```

This writes the Pblock constraint information for both Pblocks in the design. Use the `-pblocks` option to select only one if desired.

Now that the floorplan is established, the next step is implementing the design.

---

## Step 6: Implementing the First Configuration

In this step, you place and route the design and prepare the static portion of the design for reuse with new Reconfigurable Modules.

### *Implementing the Design*

1. Optimize, place, and route the design by issuing the following command:

```
opt_design
```

This is the point at which the Partial Reconfiguration license is checked. If you have a valid license, you see this message:

```
Feature available: PartialReconfiguration
```

If you have no license with the `PartialReconfiguration` feature, contact your local Xilinx sales office for more information. Evaluation licenses are available.

```
place_design
```

```
route_design
```

After both `place_design` and `route_design`, examine the state of the design in the Device view (See [Figure 6](#)). One thing to note after `place_design` is the introduction of Partition Pins. These are the physical interface points between static and reconfigurable logic. They are anchor points within an interconnect tile through which each I/O of the Reconfigurable Module must route. They appear as white boxes in the placed design view.

For `pblock_shift`, they appear in the top of that Pblock, as the connections to static are just outside the Pblock in that area of the device. For `pblock_count`, they appear outside the user-defined region, as SNAPPING\_MODE vertically collects more frames to be added to the Reconfigurable Partition.

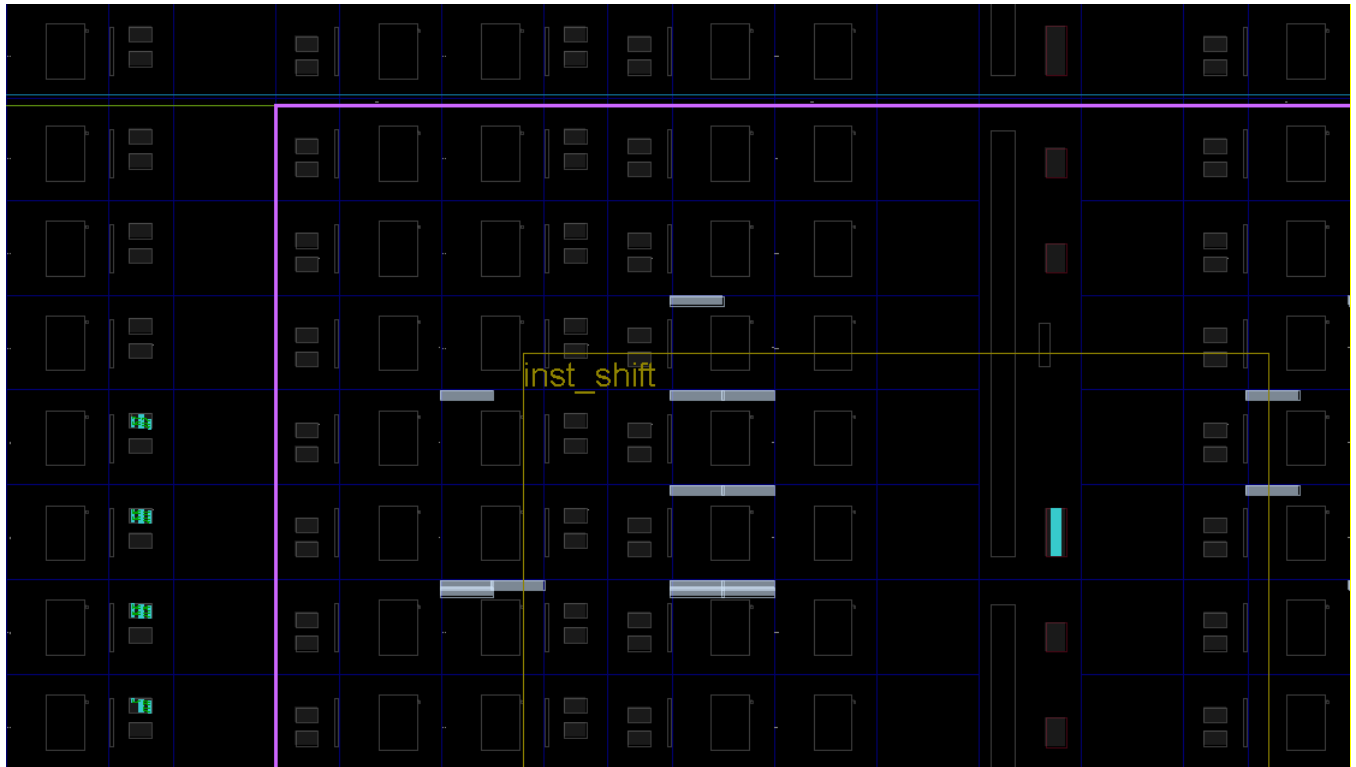

**Figure 6: Partition Pins within Placed Design**

2. To find these partition pins in the GUI easily:
  - c. Select the Reconfigurable Module (for example, `inst_shift`) in the Netlist pane.
  - d. Select the **Cell Pins** tab in the Cell Properties pane.
3. Select any pin to highlight it, or use **Ctrl+A** to select them all. The Tcl equivalent of the latter is:

```
select_objects [get_pins inst_shift/*]
```

4. In the routed design view, click the **Settings** button  to ensure that all routes by type (Fully Routed, Partially Routed, or Unrouted) are visible, as shown in [Figure 7](#).

Use the **Routing Resources** toolbar button  to toggle between abstracted and actual routing information, and to change the visibility of the routing resources themselves. All nets in the design are fully routed at this point.

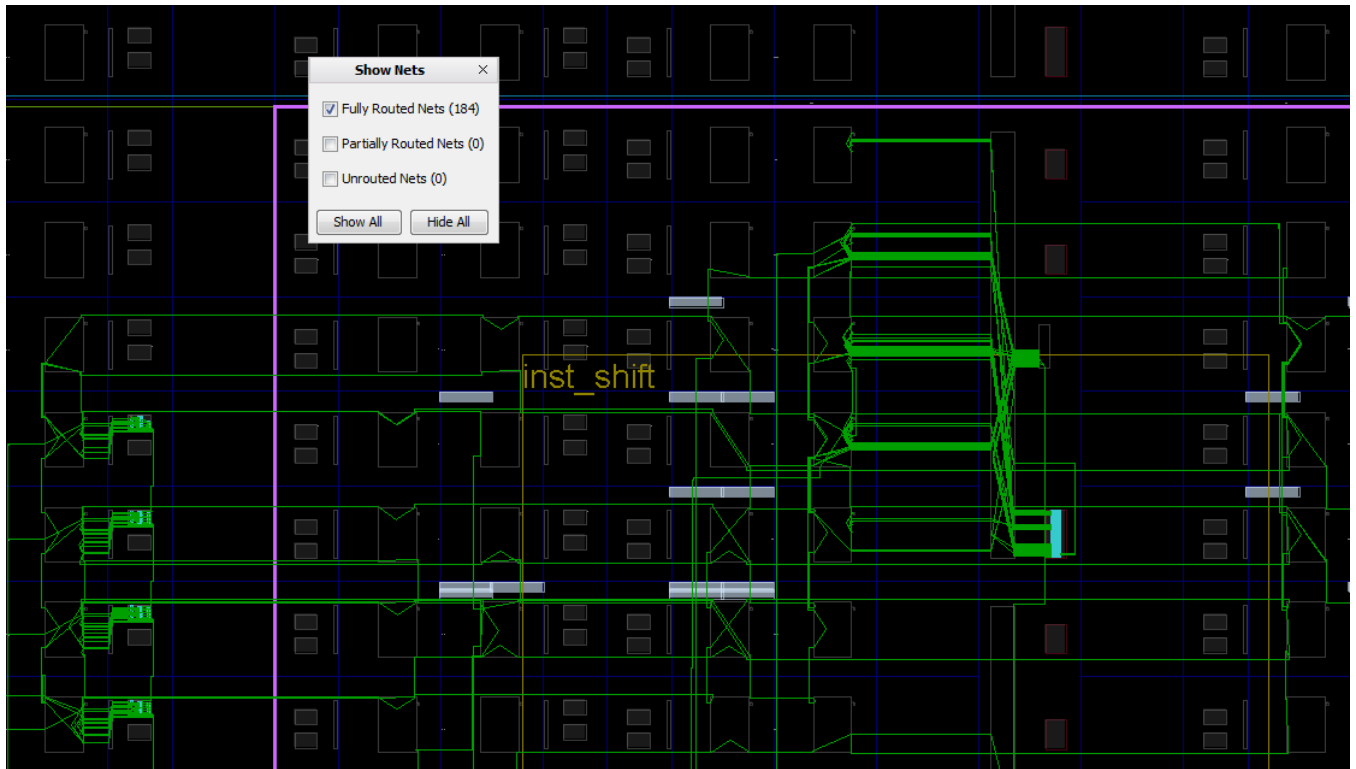

Figure 7: Close-up of First Configuration Routed

## Saving the Results

1. Save the full design checkpoint and create report files by issuing these commands:

```
write_checkpoint -force
    Implement/Config_shift_right_count_up_implementation/top_route_design.dcp
```

```
report_utilization -file
    Implement/Config_shift_right_count_up_implementation/top_utilization.rpt
```

```
report_timing_summary -file
    Implement/Config_shift_right_count_up_implementation/top_timing_summary.rpt
```

2. [Optional] Save checkpoints for each of the Reconfigurable Modules by issuing these two commands:

```
write_checkpoint -force -cell inst_shift Checkpoint/shift_right_route_design.dcp
```

```
write_checkpoint -force -cell inst_count Checkpoint/count_up_route_design.dcp
```



**TIP:** When running *design\_complete.tcl* to process the entire design in batch mode; design checkpoints, log files, and report files are created at each step of the flow.

At this point, you have created a fully implemented partial reconfiguration design from which you can generate full and partial bitstreams. The static portion of this configuration is used for all subsequent configurations. To isolate the static design, remove the current Reconfigurable Modules. Make sure routing resources are enabled, and zoom in to an interconnect tile with partition pins.

3. Clear out Reconfigurable Module logic by issuing the following commands:

```
update_design -cell inst_shift -black_box  
update_design -cell inst_count -black_box
```

Issuing these commands results in many design changes as shown in the figure below:

- o The number of Fully Routed nets (green) decreases.
- o `inst_shift` and `inst_count` now appear in the Netlist view as empty.

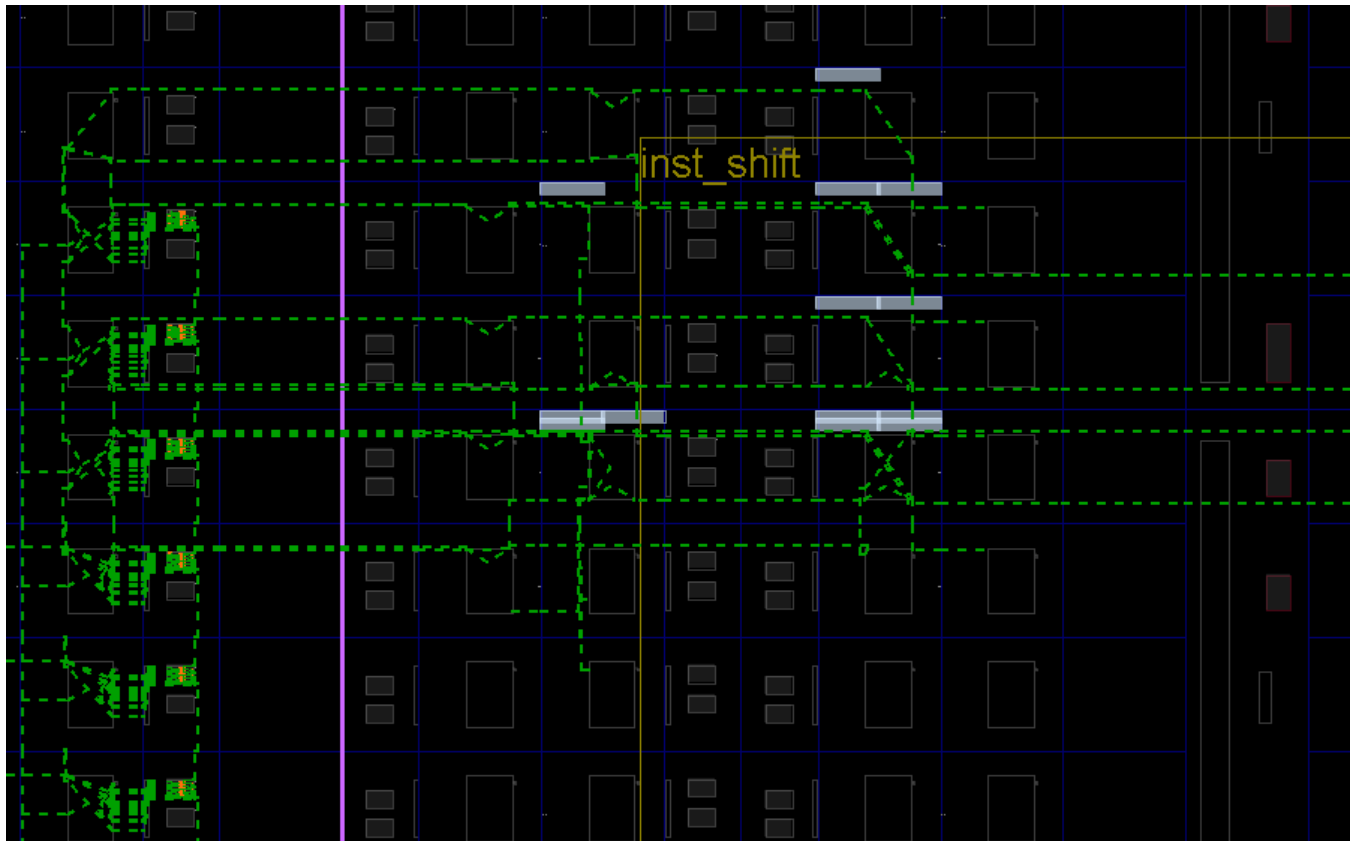

**Figure 8: The `inst_shift` module before (top) and after (bottom) `update_design -black_box`**

4. Issue the following command to lock down all placement and routing:

```
lock_design -level routing
```

Because no cell was identified in the `lock_design` command, the entire design in memory (currently consisting of the static design with black boxes) is affected. All routed nets are now displayed as locked, as indicated by dashed lines in the figure below. All placed components changed from blue to orange to show they are also locked.



**Figure 9: Close-up of Static-Only Design with Locked Routing**

5. Issue the following command to write out the remaining static-only checkpoint:

```
write_checkpoint -force Checkpoint/static_route_design.dcp
```

This static-only checkpoint is used for future configurations.

6. Close this design before moving on to the next configuration:

```
close_project
```

## Step 7: Implementing the Second Configuration

Now that the static design result is established and locked, and you can use it as context for implementing further Reconfigurable Modules.

### *Implementing the Design*

1. Create a new in-memory design by issuing the following command in the Tcl Console:

```
create_project -in_memory -part <part>
```

2. Load the static design by issuing the following command:

```
add_files ./Checkpoint/static_route_design.dcp
```

3. Load the second two synthesis checkpoints for the shift and count functions by issuing these commands:

```
add_file ./Synth/shift_left/shift_synth.dcp
```

```
set_property SCOPED_TO_CELLS {inst_shift} [get_files  
./Synth/shift_left/shift_synth.dcp]
```

```
add_file ./Synth/count_down/count_synth.dcp
```

```
set_property SCOPED_TO_CELLS {inst_count} [get_files  
./Synth/count_down/count_synth.dcp]
```

4. Link the entire design together using the link\_design command:

```
link_design -mode default -reconfig_partitions {inst_shift inst_count}  
-part <part> -top
```

At this point, a full configuration is loaded. This time, however, the static design is routed and locked, and the reconfigurable logic is still just a netlist. Place and route from here only applies to the RM logic.

5. Optimize, place and route the new RMs in the context of static by issuing these commands:

```
opt_design
```

```
place_design
```

```
route_design
```

The design is again fully implemented, now with the new Reconfigurable Module variants. The routing is a mix of dashed (locked) and solid (new) routing segments, as shown below.

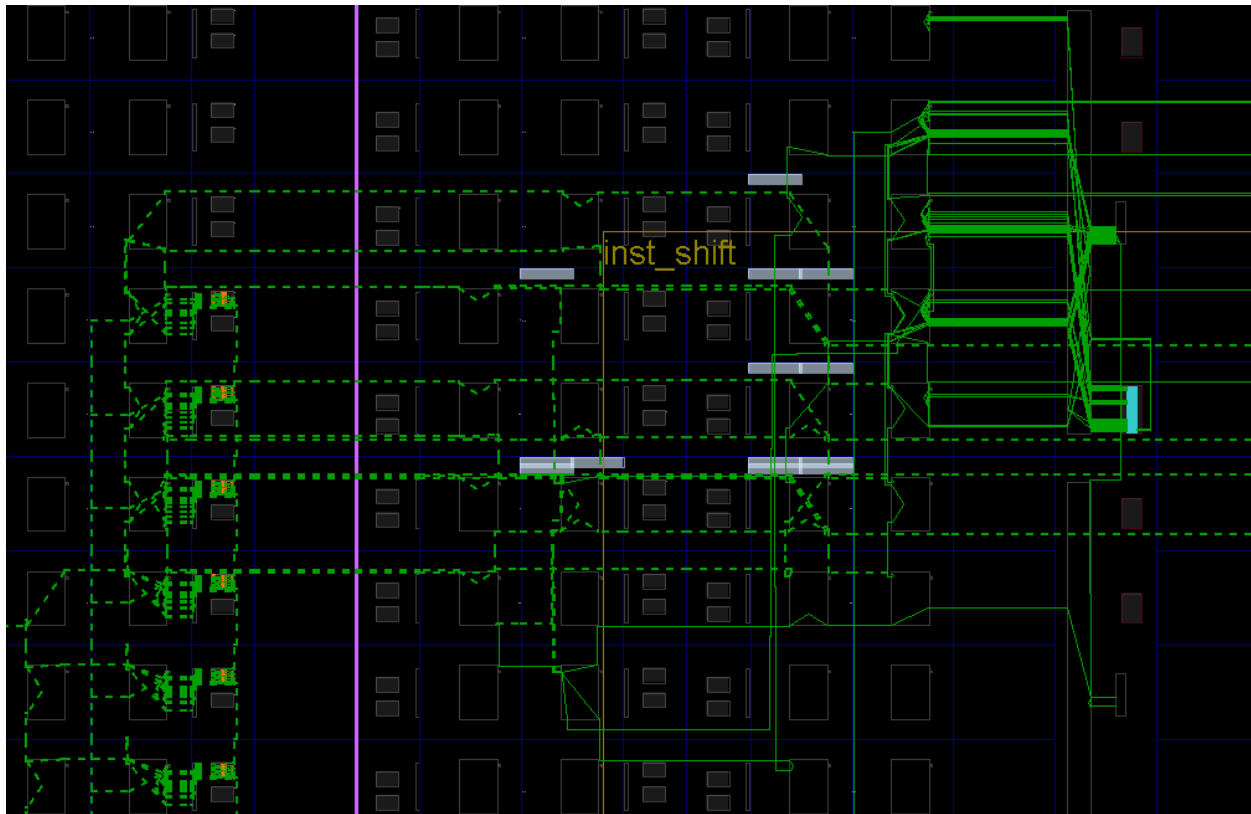

**Figure 10: Second Configuration Routed, Showing Locked and New Routes**

## ***Saving the Results***

1. Save the full design checkpoint and report files by issuing these commands:

```
write_checkpoint -force
    Implement/Config_shift_left_count_down_import/top_route_design.dcp
```

```
report_utilization -file
    Implement/Config_shift_left_count_down_import/top_utilization.rpt
```

```
report_timing_summary -file
    Implement/Config_shift_left_count_down_import/top_timing_summary.rpt
```

2. [Optional] Save checkpoints for each of the Reconfigurable Modules by issuing these two commands:

```
write_checkpoint -force -cell inst_shift Checkpoint/shift_left_route_design.dcp
```

```
write_checkpoint -force -cell inst_count Checkpoint/count_down_route_design.dcp
```

At this point, you have implemented the static design and all Reconfigurable Module variants. Repeat this process for designs that have more than two Reconfigurable Modules per Reconfigurable Partition.



## Step 8: Examining the Results with Highlighting Scripts

With the routed configuration open in the IDE, run some visualization scripts to highlight tiles and nets. These scripts identify the resources allocated for partial reconfiguration, and are automatically generated.

1. In the Tcl Console, issue the following commands from the <Extract\_Dir> directory:
 

```
source hd_visual/pblock_inst_shift_AllTiles.tcl
highlight_objects -color blue [get_selected_objects]
```
2. Click somewhere in the Device view to deselect the frames (or enter `unselect_objects`), then issue the following commands:

```
source hd_visual/pblock_inst_count_AllTiles.tcl
highlight_objects -color yellow [get_selected_objects]
```

The partition frames appear highlighted in the Device view, as shown in [Figure 11](#).

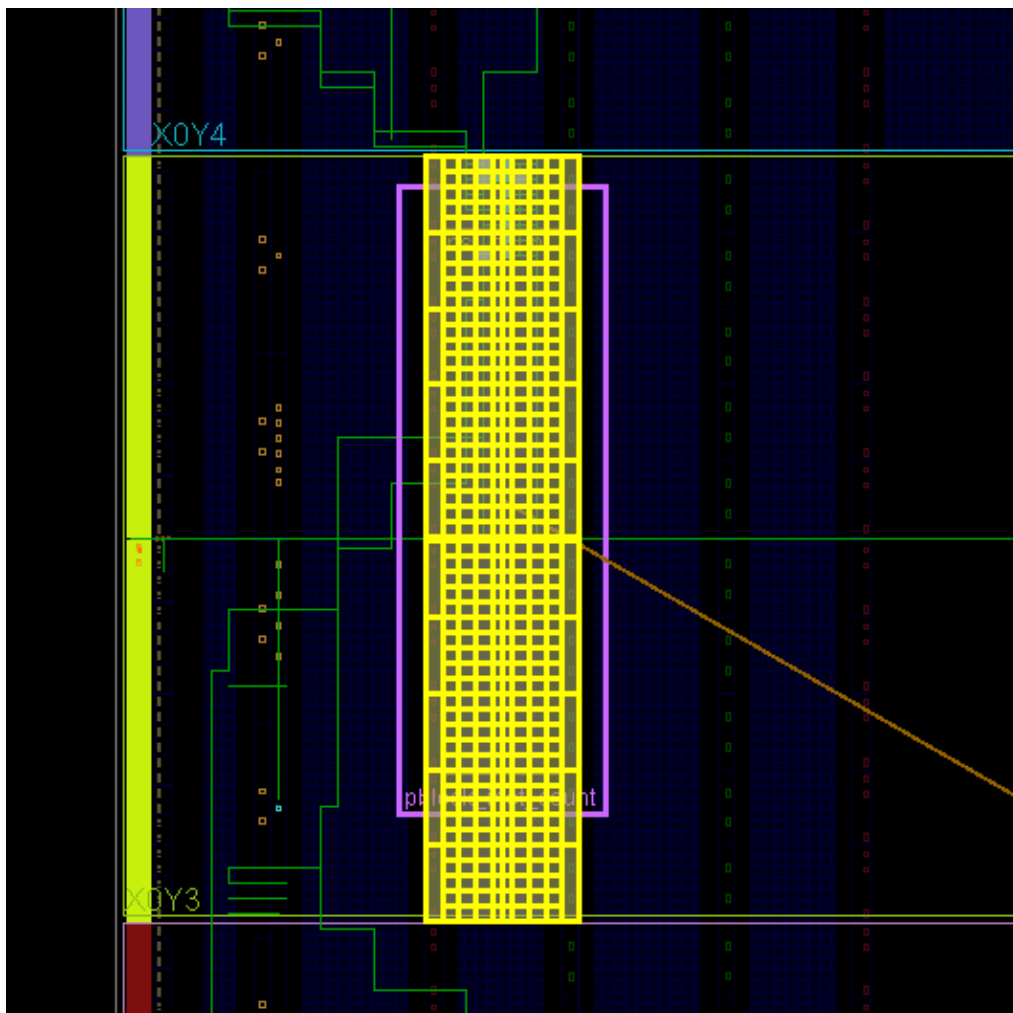

Figure 11: Reconfigurable Partition Frames Highlighted

These highlighted tiles represent the configuration frames that are sent to bitstream generation to create the partial bitstreams. As shown above, the `SNAPPING_MODE` feature adjusted all four edges of `pblock_count` to account for `RESET_AFTER_RECONFIG` and legal reconfigurable partition widths.

The other “tile” scripts are variations on these. If you had not created Pblocks that vertically aligned to the clock region boundaries, the `FrameTiles` script would highlight the explicit Pblock tiles, while the `AllTiles` script extends those tiles to the full reconfigurable frame height. Note that these leave gaps where unselected frame types (for example: global clocks) exist.

The `GlitchTiles` script is a subset of frame sites, avoiding dedicated silicon resources; the other scripts are more informative than this one.

3. Close the current design:

```
close_project
```

---

## Step 9: Generating Bitstreams

### Verifying Configurations



**RECOMMENDED:** Before generating bitstreams, verify all configurations to ensure that the static portion of each configuration match identically, so the resulting bitstreams are safe to use in silicon. The PR Verify feature examines the complete static design up to and including the partition pins, confirming that they are identical. Placement and routing within the Reconfigurable Modules is not checked, as different module results are expected here.

1. Run the `pr_verify` command from the Tcl Console:

```
pr_verify
  Implement/Config_shift_right_count_up/Implement/top_route_design.dcp
  Implement/Config_shift_left_count_down_import/top_route_design.dcp
```

If successful, this command returns the following message.

```
INFO: [Vivado 12-3253] PR_VERIFY: check points
Implement/Config_shift_right_count_up/top_route_design.dcp and
Implement/Config_shift_left_count_down/top_route_design.dcp are compatible
```

By default, only the first mismatch (if any) is reported. To see all mismatches, use the `-full_check` option.

## Generating Bitstreams

Now that the configurations have been verified, you can generate bitstreams and use them to target your selected demonstration board.

1. First, read the first configuration into memory:

```
open_checkpoint
  Implement/Config_shift_right_count_up_implement/top_route_design.dcp
```

2. Generate full and partial bitstreams for this design. Be sure to keep the bit files in a unique directory related to the full design checkpoint from which they were created.

```
write_bitstream -force -file Bitstreams/Config_RightUp.bit

close_project
```

Notice that three bitstreams have been created:

- o Config\_RightUp.bit  
This is the power-up, full design bitstream.
- o Config\_RightUp\_pblock\_inst\_shift\_partial.bit  
This is the partial bit file for the shift\_right module.
- o Config\_RightUp\_pblock\_inst\_count\_partial.bit  
This is the partial bit file for the count\_up module.

---

**IMPORTANT:** When generated by a single call to `write_bitstream`, the names of the bit files currently do not reflect the name of the Reconfigurable Module variant to clarify which image is loaded. The current solution uses the base name given by the `-file` option and appends the Pblock name of the reconfigurable cell. It is critical to provide enough description in the base name to be able to identify the reconfigurable bit files clearly. All partial bit files have the `_partial` postfix.

---



Using `design_complete.tcl` to process the entire design through bitstream generation uses a different technique for generating the bitstreams. Opening a routed design checkpoint issues multiple calls to `write_bitstream`, which gives you more control over naming bitstreams and allows for different options (such a bitstream compression) to be applied to full versus partial bitstreams. For example, the names selected in the full `design_complete.tcl` script are:

- o Config\_shift\_right\_count\_up\_implement\_full.bit  
This is the power-up, full design bitstream.
- o pblock\_shift\_shift\_right\_partial.bit  
This is the partial bit file for the shift\_right module.
- o pblock\_count\_count\_up\_partial.bit  
This is the partial bit file for the count\_up module.

3. Generate full and partial bitstreams for the second configuration, again keeping the resulting bit files in the appropriate folder.

```
open_checkpoint Implement/Config_shift_left_count_down_import/top_route_design.dcp
write_bitstream -force -file Bitstreams/Config_LeftDown.bit
close_project
```

Similarly, you see three bitstreams created, this time with a different base name.

4. Generate a full bitstream with grey boxes, plus blanking bitstreams for the Reconfigurable Modules. Blanking bitstreams can be used to “erase” an existing configuration to reduce power consumption.

```
open_checkpoint Checkpoint/static_route_design.dcp
update_design -cell inst_count -buffer_ports
update_design -cell inst_shift -buffer_ports
place_design
route_design
write_checkpoint -force Checkpoint/Config_greybox.dcp
write_bitstream -force -file Bitstreams/config_greybox.bit
close_project
```

The base configuration bitstream has no logic for either reconfigurable partition. The `update_design` commands here insert constant drivers (ground) for all outputs of the Reconfigurable Partitions, so these outputs do not float. The term *grey box* indicates that the modules are not completely empty with these LUTs inserted, as opposed to black boxes, which would have dangling nets in and out of this region. The `place_design` and `route_design` commands ensure they are completely implemented.

---

## Step 10: Partially Reconfiguring the FPGA

The `count_shift_led` design targets one of four demonstration boards. The current design supports the KC705, VC707, VC709 and AC701 boards, revisions Rev 1.0 and Rev 1.1.

### ***Configuring the Device with a Full Image***

1. Connect the board to your computer via the Platform Cable USB and power on the board.
2. From the main Vivado IDE, select **Flow > Open Hardware Manager**.
3. Select **Open a new hardware target** on the green banner. Follow the steps in the wizard to establish communication with the board.

4. Select **Program device** on the green banner, and select the target device. Navigate to the `Bitstreams` folder to select `Config_RightUp.bit`, then click **OK** to program the device.

You should now see the bank of GPIO LEDs performing two tasks. Four LEDs are performing a counting-up function (MSB is on the left), and the other four are shifting to the right. Note the amount of time it took to configure the full device.

**Note:** The AC701 demonstration board only has a 4-bit LED bank. This design will show either the shift function or the count function at one time. To switch between the shift and count functions, toggle the switch 1 on the GPIO DIP switch (SW2).

## Partially Reconfiguring the Device

At this point, you can partially reconfigure the active device with any of the partial bitstreams that you have created.

1. Select **Program device** on the green banner again. Navigate to the `Bitstreams` folder to select `Config_LeftDown_pblock_inst_shift_partial.bit`, then click **OK** to program the device.

The shift portion of the LEDs changed direction, but the counter kept counting up, unaffected by the reconfiguration. Note the much shorter configuration time.

2. Select **Program device** on the green banner again. Navigate to the `Bitstreams` folder to select `Config_LeftDown_pblock_inst_count_partial.bit`, then click **OK** to program the device.

The counter is now counting down, and the shifting LEDs were unaffected by the reconfiguration. This process can be repeated with the `Config_RightUp` partial bit files to return to the original configuration, or with the blanking (grey box) partial bit files to stop activity on the LEDs (that will stay on).

---

## Conclusion

This concludes lab 1. In this lab, you:

- Synthesized a design bottom-up to prepare for partial reconfiguration implementation
- Created a valid floorplan for a partial reconfiguration design
- Created two configurations with common static results
- Implemented these two configurations, saving the static design to be used in each
- Created checkpoints for static and reconfigurable modules for later reuse
- Examined framesets and verified the two configurations
- Created full and partial bitstreams
- Configured and partially reconfigured an FPGA

## Lab 2: UltraScale Basic Partial Reconfiguration Flow

---

### Step 1: Extracting the Tutorial Design Files

1. To obtain the tutorial design file, see the Tutorial Design Description.
  2. Navigate to `\led_shift_count_us` in the extracted files. The `led_shift_count_us` data directory is referred to in this lab as the `<Extract_Dir>`.
- 

### Step 2: Examining the Scripts

Start by reviewing the scripts provided in the design archive. The files `design.tcl` and `design_complete.tcl` are located at the root level. Both files contain the same information, but `design.tcl` has parameters set such that only synthesis runs, while `design_complete.tcl` runs the entire flow for two configurations.

#### The Main Script

In the `<Extract_Dir>`, open `design.tcl` in a text editor. This is the master script where you define the design parameters, design sources, and design structure. This is the only file you have to modify to compile a complete Partial Reconfiguration design. Find more details regarding `design.tcl` and the underlying scripts in the `README.txt` located in the `Tcl_HD` subdirectory.

Note the following details in this file:

- Under **Define target demo board**, you can select one of many demonstration boards supported for this design. To select one, uncomment the single desired board.
- Under **flow control**, you can control what phases of synthesis and implementation are run. In the tutorial, only synthesis is run by the script; implementation, verification, and bitstream generation are run interactively. To run these additional steps via the script, set the flow variables (e.g., `run.prImpl`) to **1**.
- The **Output Directories** and **Input Directories** set the file structure expected for design sources and results files. You must reflect any changes to your file structure here.

- The **Top Definition** and **RP Module Definitions** sections let you reference all source files for each part of your design. **Top Definition** covers all sources needed for the static design, including constraints and IP. The **RP Module Definitions** section does the same for Reconfigurable Partitions (RP). Complete a section for each RP and list all Reconfigurable Module (RM) variants for each RP.
  - This design has two Reconfigurable Partitions (`inst_shift` and `inst_count`), and each RP has two module variants.
- The **Configuration Definition** sections define the sets of static and reconfigurable modules that make up a configuration.
  - This design has two configurations defined within the master script: `config_shift_right_count_up_implement` and `config_shift_left_count_down_import`.
  - You can create more configurations by adding RMs or by combining existing RMs.

## The Supporting Scripts

Underneath the `Tcl_HD` subdirectory, several supporting Tcl scripts exist. The scripts are called by `design.tcl`, and they manage specific details for the Partial Reconfiguration flow. Provided below are some details about a few of the key PR scripts.



**CAUTION!** Do not modify the supporting Tcl scripts.

- `step.tcl`  
Manages the current status of the design by monitoring checkpoints.
- `synthesize.tcl`  
Manages all the details regarding the synthesis phase.
- `implement.tcl`  
Manages all the details regarding the module implementation phase.
- `pr_utils.tcl`  
Manages all the details regarding the top-level implementation of a PR design.
- `run.tcl`  
Launches the actual runs for synthesis and implementation.
- `log_utils.tcl`  
Handles report file creation at key points during the flow.

Remaining scripts provide details within these scripts (such as other `*_utils.tcl` scripts) or manage other Hierarchical Design flows (such as `hd_utils.tcl`).

---

## Step 3: Synthesizing the Design

The `design.tcl` script automates the synthesis phase of this tutorial. Five iterations of synthesis are called, one for the static top-level design and one for each of four Reconfigurable Modules.

1. Open the Vivado Tcl shell:
  - On Windows, select the Xilinx Vivado desktop icon or **Start > All Programs > Xilinx Design Tools > Vivado 2017.x > Vivado 2017.x Tcl Shell**.
  - On Linux, type: `vivado -mode tcl`.
2. In the shell, navigate to the `<Extract_Dir>` directory.
3. If you are using a target demonstration board other than the KCU105, modify the `xboard` variable in `design.tcl`. The alternative for this lab is the VCU108 board.
4. Run the `design.tcl` script by entering:

```
source design.tcl -notrace
```

After all five passes through Vivado Synthesis have completed, the Vivado Tcl shell is left open. You can find log and report files for each module, alongside the final checkpoints, under each named folder in the `Synth` subdirectory.

---

**TIP:** In the `<Extract_Dir>` directory, multiple log files have been created:



- `run.log` shows the summary as posted in the Tcl shell window
  - `command.log` echoes all the individual steps run by the script
  - `critical.log` reports all critical warnings produced during the run.
- 

---

## Step 4: Assembling and Implementing the Design

Now that the synthesized checkpoints for each module, plus top, are available, you can assemble the design. Because project support for Partial Reconfiguration flows is not yet in place, you do not use the project infrastructure from within the IDE.

You will run all flow steps from the Tcl Console, but you can use features within the IDE (such as the floorplanning tool) for interactive events.



---

**TIP:** Copy and paste commands directly from this document to avoid redundant effort and typos in the Vivado IDE. Copy and paste only one full command at a time. Note that some commands are long and therefore span multiple lines.

---



1. Open the Vivado IDE. You can open the IDE from the open Tcl shell by typing `start_gui` or by launching Vivado with the command `vivado -mode gui`.
2. Navigate to the `<Extract_Dir>` directory if you are not already there. The `pwd` command can confirm this.
3. Create an in-memory design by issuing the following command in the Tcl Console:  

```
create_project -in_memory -part <part>
```

`<part>` (here and later on) is one of the four target devices supported by this lab:

  - o `xcku040ffva1156-2`
  - o `xcvu095ffva2104-2`

4. Load the static design by issuing the following command:

```
add_files ./Synth/Static/top_synth.dcp
```

5. Load the top-level design constraints by issuing these commands:

```
add_files ./Sources/xdc/top_io_<board>.xdc
```

```
set_property USED_IN {implementation} [get_files  
./Sources/xdc/top_io_<board>.xdc]
```

`<board>` (here and later on) is one of the two target platforms supported by this lab:

- o `kcu105`
- o `vcu108`

Selecting the `top_io_<board>` version of the available xdc file loads the pin location and clocking constraints, but does not include floorplan information. The `top_<board>` version includes pin location, clocking and floorplanning constraints.

6. Load the first two synthesis checkpoints for the shift and count functions by issuing these commands:

```
add_file ./Synth/shift_right/shift_synth.dcp
```

```
set_property SCOPED_TO_CELLS {inst_shift} [get_files  
./Synth/shift_right/shift_synth.dcp]
```

```
add_file ./Synth/count_up/count_synth.dcp
```

```
set_property SCOPED_TO_CELLS {inst_count} [get_files  
./Synth/count_up/count_synth.dcp]
```

The `SCOPED_TO_CELLS` property ensures that the proper assignment is made to the target cell. See this [link](#) in *Vivado Design Suite User Guide: Using Constraints (UG903)* for more information.

7. Link the entire design together using the `link_design` command:

```
link_design -mode default -reconfig_partitions {inst_shift inst_count}
-part <part> -top top
```

At this point a full configuration is loaded, including static and reconfigurable logic. Note that the Flow Navigator pane is not present while you are working in non-project mode.



**TIP:** Place the IDE in floorplanning mode by selecting **Layout > Floorplanning**. Make sure the Device view is visible.

8. Define each of these submodules as partially reconfigurable by setting the `HD.RECONFIGURABLE` property:

```
set_property HD.RECONFIGURABLE 1 [get_cells inst_shift]
set_property HD.RECONFIGURABLE 1 [get_cells inst_count]
```

9. Save the assembled design state for this initial configuration:

```
write_checkpoint ./Checkpoint/top_link_right_up.dcp
```

---

## Step 5: Building the Design Floorplan

Next, create a floorplan to define the regions for partial reconfiguration.

1. Select the `inst_count` instance in the Netlist pane. Right click and select **Floorplanning > Draw Pblock** and draw a tall narrow box on the left side of the X0Y4 clock region, which is the upper left corner of the device. The exact size and shape do not matter at this point, but keep the box within the clock region.

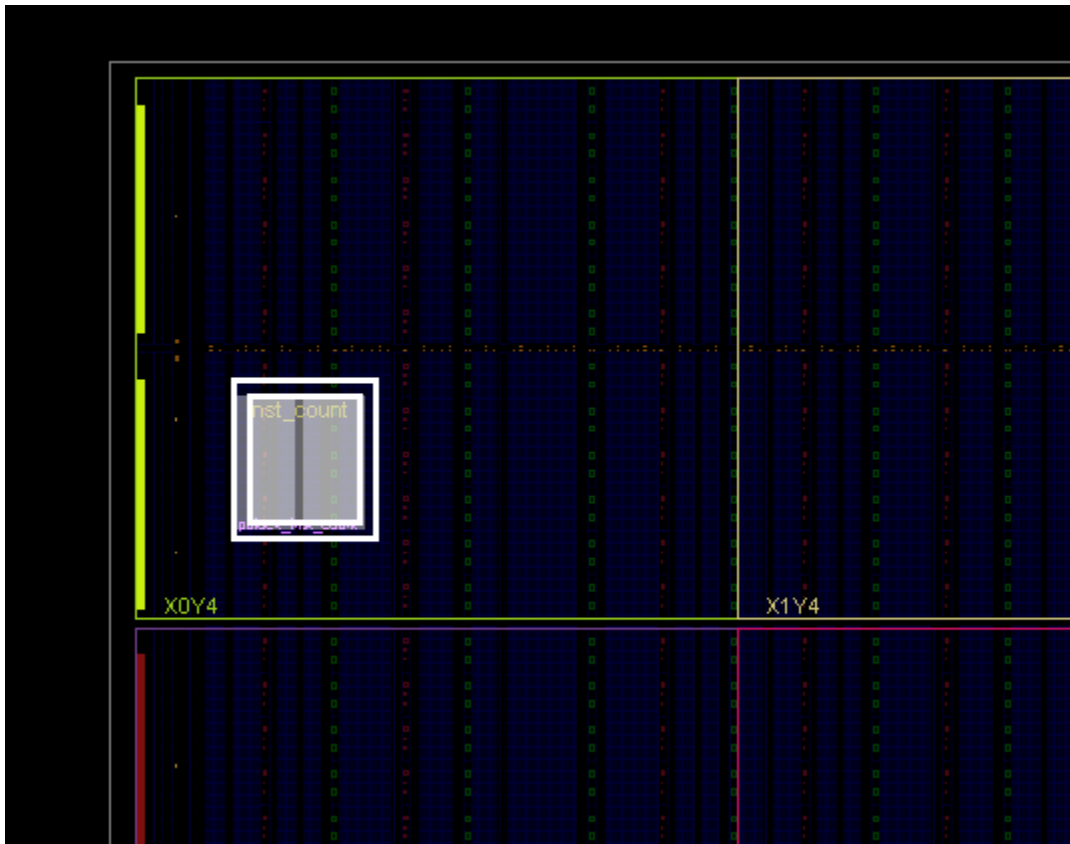

**Figure 12: Pblock for the inst\_count Reconfigurable Partition**

Although this Reconfigurable Module only requires CLB resources, also include RAMB16, RAMB32, or DSP48 resources if the box encompasses those types. This allows the routing resources for these block types to be included in the reconfigurable region. The **General** tab of the Pblock Properties pane can be used to add these if needed. The **Statistics** tab shows the resource requirements of the currently loaded Reconfigurable Module.

2. Repeat the previous step for the `inst_shift` instance, this time targeting clock region X0Y3. This Reconfigurable Module includes block RAM instances, so the resource type must be included. If omitted, the RAMB details in the **Statistics** tab will be shown in red.

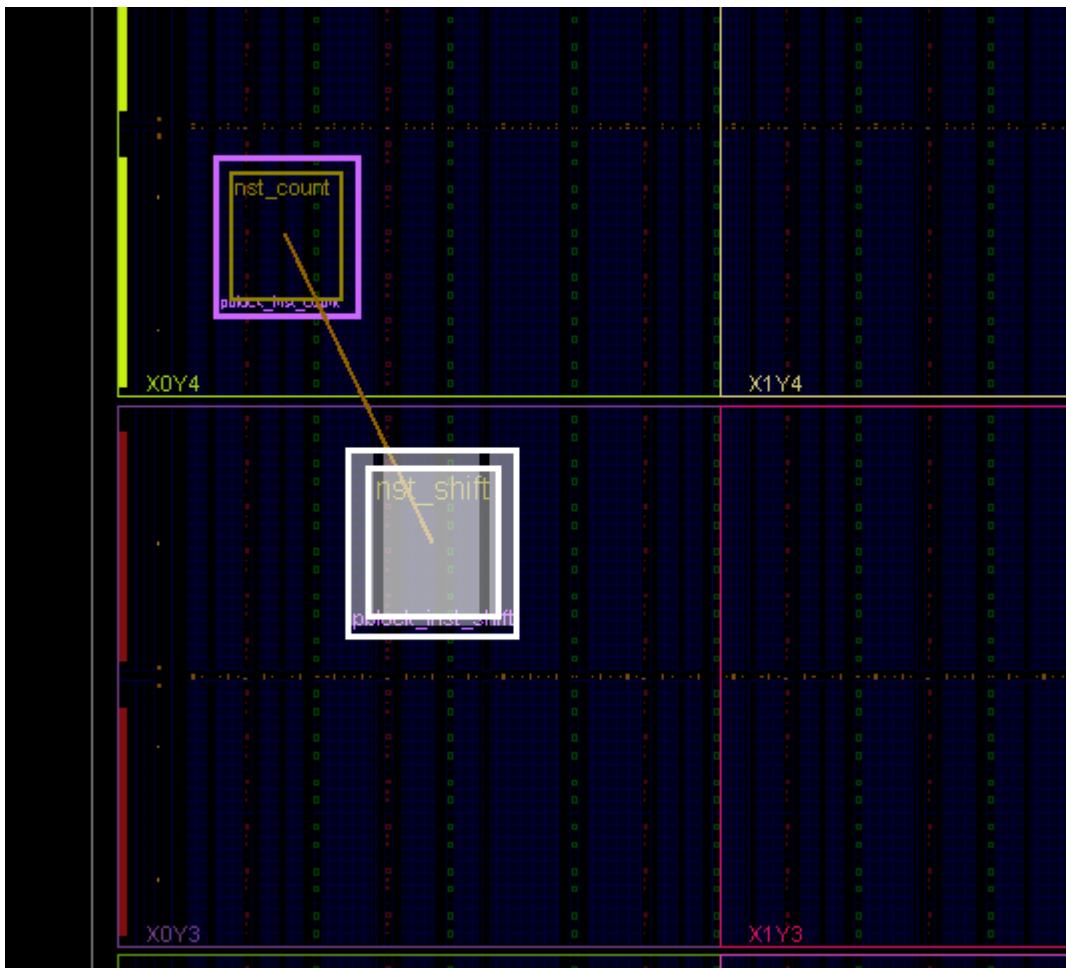

**Figure 13: Pblock for the inst\_shift Reconfigurable Partition**

3. Run Partial Reconfiguration Design Rule Checks by selecting **Tools > Report > Report DRC**. You can uncheck **All Rules** and then check **Partial Reconfiguration** to focus this report strictly on PR DRCs.

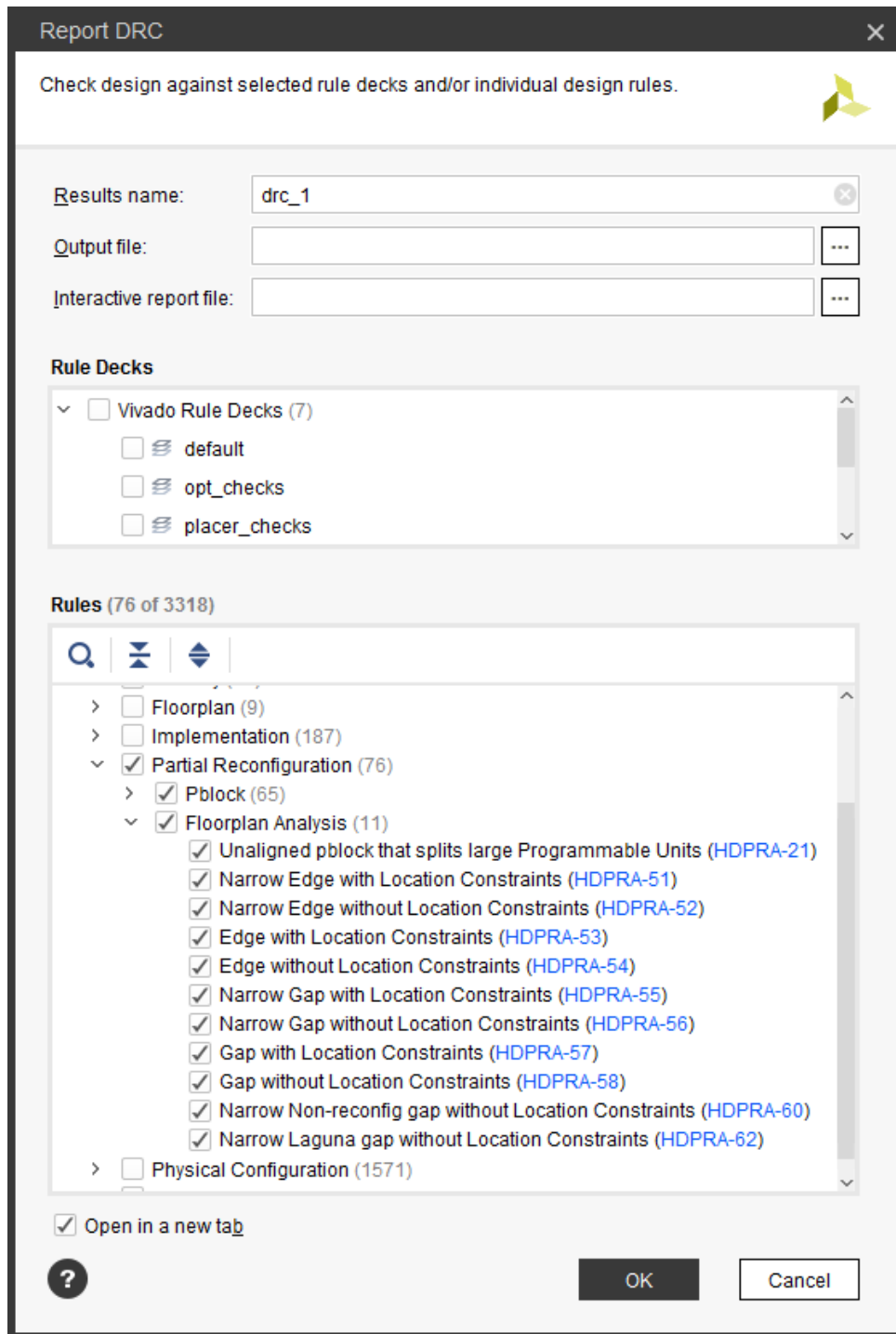

**Figure 14: Partial Reconfiguration Design Rule Checks (DRCs)**

No DRCs should be reported, as long as the `inst_shift` pblock includes RAMB18 and RAMB36 resources. Note that for both pblocks, `SNAPPING_MODE` is set to ON, as reported in the **Properties** tab of the Pblock Properties pane. This is always enabled for all UltraScale devices given the fine granularity of programmable units in this architecture.

4. Save these Pblocks and associated properties:

```
write_xdc ./Sources/xdc/top_all.xdc
```

This exports all the current constraints in the design, including those imported earlier from `top_io_<board>.xdc`. These constraints can be managed in their own XDC file or managed within a run script (as is typically done with `HD.RECONFIGURABLE`).

Alternatively, the Pblock constraints themselves can be extracted and managed separately. A Tcl proc is available to help perform this task.

- a. First source the proc which is found in one of the Tcl utility files:

```
source ./Tcl_HD/hd_utils.tcl
```

- b. Then use the `export_pblocks` proc to write out this constraint information:

```
export_pblocks -file ./Sources/xdc/pblocks.xdc
```

This writes the Pblock constraint information for both Pblocks in the design. Use the `-pblocks` option to select only one if desired.

Now that the floorplan is established, the next step is implementing the design.

---

## Step 6: Implementing the First Configuration

In this step, you place and route the design and prepare the static portion of the design for reuse with new Reconfigurable Modules.

### *Implementing the Design*

1. Optimize, place, and route the design by issuing the following commands:

```
opt_design
```

This is the point at which the Partial Reconfiguration license is checked. If you have a valid license, you see this message:

```
Feature available: PartialReconfiguration
```

If you have no license with the `PartialReconfiguration` feature, contact your local Xilinx sales office for more information. Evaluation licenses are available.

```
place_design
```

```
route_design
```

After both `place_design` and `route_design`, examine the state of the design in the Device view (see Figure 15). One thing to note after `place_design` is the introduction of Partition Pins. These are the physical interface points between static and reconfigurable logic. They are anchor points within an interconnect tile through which each I/O of the Reconfigurable Module must route. They appear as white boxes in the placed design view. For `pblock_shift`, they appear in the top of that Pblock, as the connections to static are just outside the Pblock in that area of the device. For `pblock_count`, they appear outside the user-defined region, as `SNAPPING_MODE` vertically collected more frames to be added to the Reconfigurable Partition.

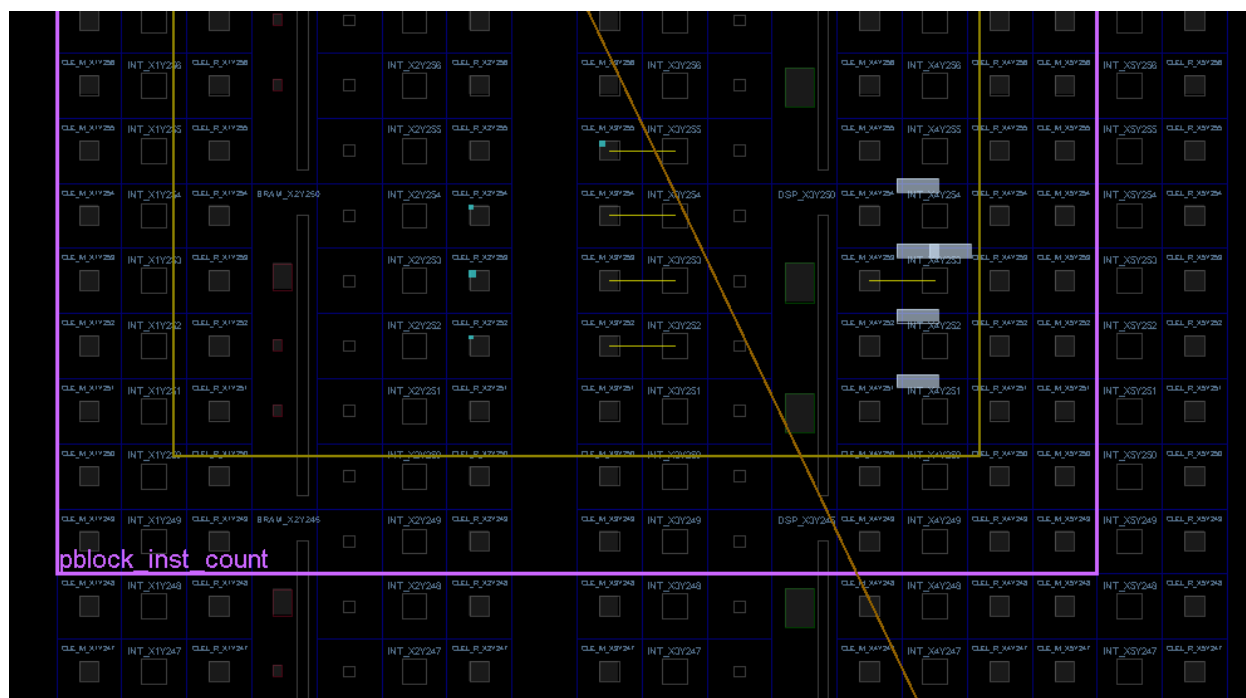



Figure 15: Partition Pins within Placed Design

2. To find these partition pins in the GUI easily:
  - a. Select the Reconfigurable Module (for example, `inst_shift`) in the Netlist pane.
  - b. Select the **Cell Pins** tab in the Cell Properties pane.
3. Select any pin to highlight it, or use **Ctrl+A** to select all. The Tcl equivalent of the latter is:

```
select_objects [get_pins inst_shift/*]
```

4. In the routed design view, click the **Settings** button  to ensure that all routes by type (Fully Routed, Partially Routed, or Unrouted) are visible, as shown in Figure 16.

Use the **Routing Resources** toolbar button  to toggle between abstracted and actual routing information, and to change the visibility of the routing resources themselves. All nets in the design are fully routed at this point.

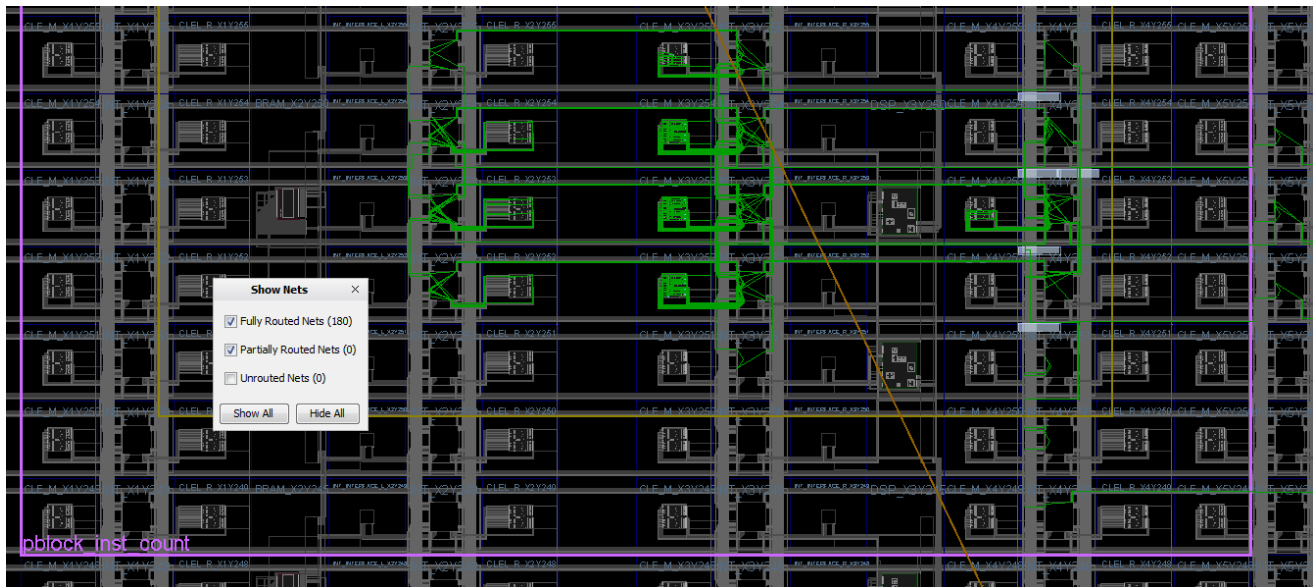

Figure 16: Close up of First Configuration Routed

## Saving the Results

1. Save the full design checkpoint and create report files by issuing these commands:

```
write_checkpoint -force
    Implement/Config_shift_right_count_up_implementation/top_route_design.dcp
```

```
report_utilization -file
    Implement/Config_shift_right_count_up_implementation/top_utilization.rpt
```

```
report_timing_summary -file
    Implement/Config_shift_right_count_up_implementation/top_timing_summary.rpt
```

2. [Optional] Save checkpoints for each of the Reconfigurable Modules by issuing these two commands:

```
write_checkpoint -force -cell inst_shift Checkpoint/shift_right_route_design.dcp
```

```
write_checkpoint -force -cell inst_count Checkpoint/count_up_route_design.dcp
```



**TIP:** When running `design_complete.tcl` to process the entire design in batch mode, design checkpoints, log files, and report files are created at each step of the flow.



At this point, you have created a fully implemented partial reconfiguration design from which you can generate full and partial bitstreams. The static portion of this configuration is used for all subsequent configurations. To isolate the static design, remove the current Reconfigurable Modules. Make sure routing resources are enabled, and zoom in to an interconnect tile with partition pins.

3. Clear out Reconfigurable Module logic by issuing the following commands:

```
update_design -cell inst_shift -black_box  
update_design -cell inst_count -black_box
```

Issuing these commands results in many design changes as shown in Figure 17:

- The number of Fully Routed nets (green) decreased.
- `inst_shift` and `inst_count` now appear in the Netlist view as empty.

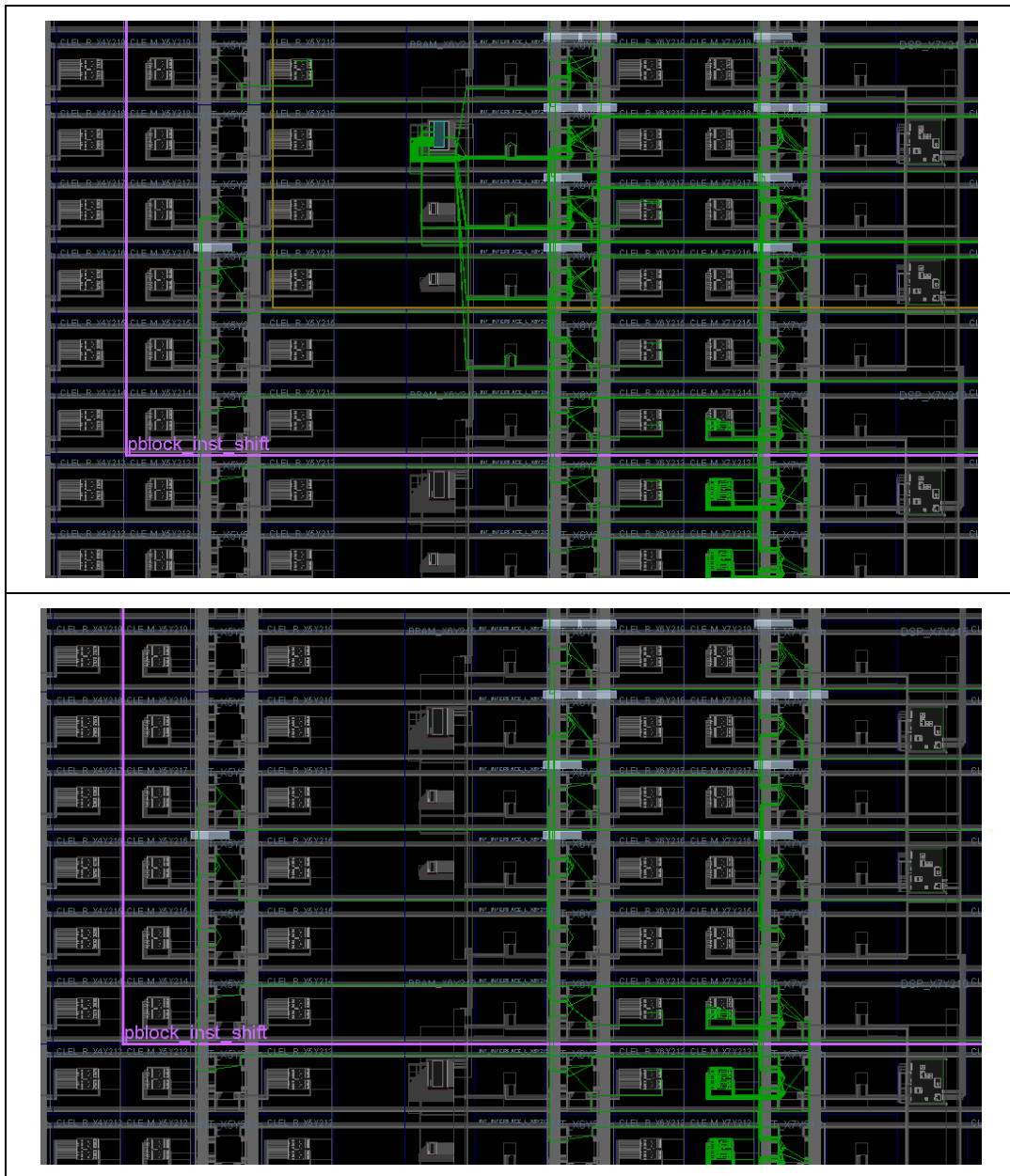
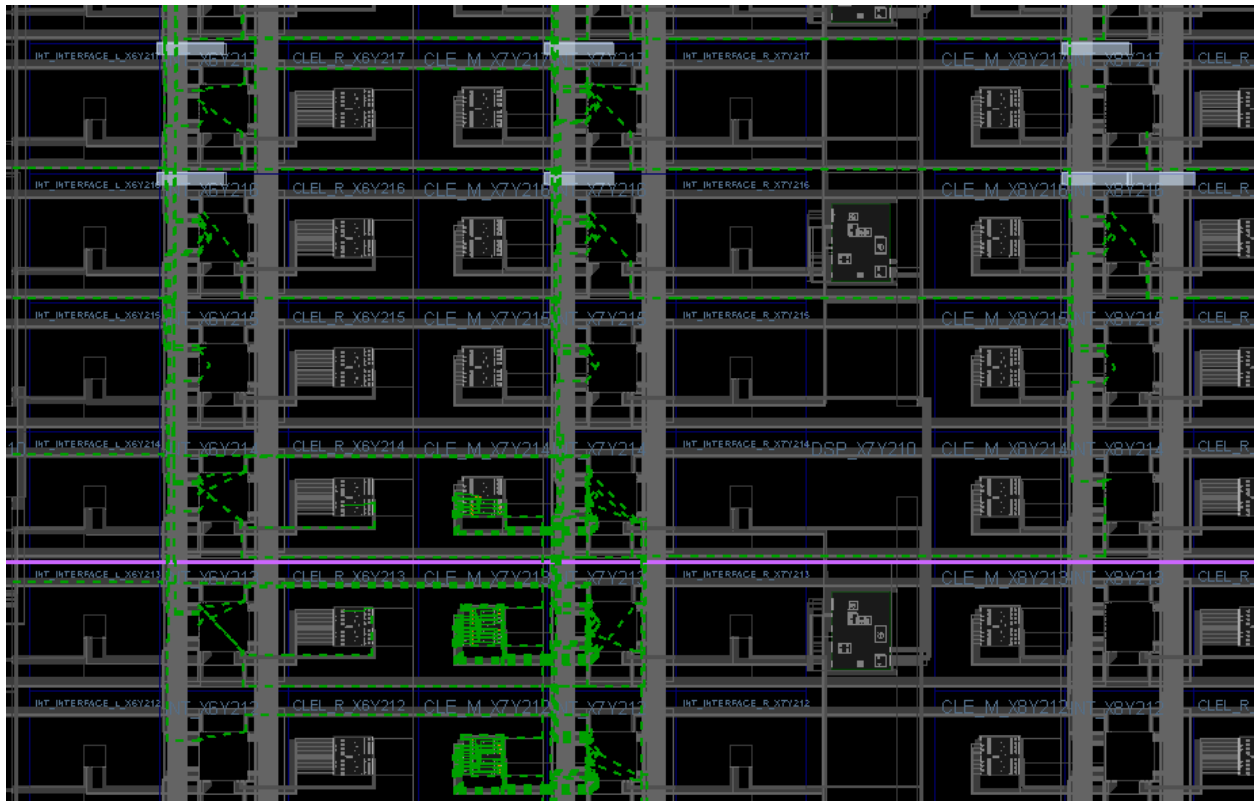

**Figure 17: The inst\_shift module before (top) and after (bottom) update\_design -black\_box**

- Issue the following command to lock down all placement and routing:

```
lock_design -level routing
```

Because no cell was identified in the `lock_design` command, the entire design in memory (currently consisting of the static design with black boxes) is affected. All routed nets now display as locked, as indicated by dashed lines in Figure 18. All placed components changed from blue to orange to show they are also locked.



**Figure 18: Close-up of Static-Only Design with Locked Routing**

5. Issue the following command to write out the remaining static-only checkpoint:

```
write_checkpoint -force Checkpoint/static_route_design.dcp
```

This static-only checkpoint is used for future configurations.

6. Close this design before moving on to the next configuration:

```
close_design
```

## Step 7: Implementing the Second Configuration

The static design result is now established and locked, and you will use it as context for implementing further Reconfigurable Modules.

### *Implementing the Design*

7. Create a new in-memory design by issuing the following command in the Tcl Console:

```
create_project -in_memory -part <part>
```

8. Load the static design by issuing the following command:

```
add_files ./Checkpoint/static_route_design.dcp
```

9. Load the second two synthesis checkpoints for the shift and count functions by issuing these commands:

```
add_file ./Synth/shift_left/shift_synth.dcp

set_property SCOPED_TO_CELLS {inst_shift} [get_files
  ./Synth/shift_left/shift_synth.dcp]

add_file ./Synth/count_down/count_synth.dcp

set_property SCOPED_TO_CELLS {inst_count} [get_files
  ./Synth/count_down/count_synth.dcp]
```

10. Link the entire design together using the link\_design command:

```
link_design -mode default -reconfig_partitions {inst_shift inst_count}
  -part <part> -top top
```

At this point, a full configuration is loaded. This time, however, the static design is routed and locked, and the reconfigurable logic is still just a netlist. Place and route from here only applies to the RM logic.

11. Optimize, place and route the new RMs in the context of static by issuing these commands:

```
opt_design
place_design
route_design
```

The design is again fully implemented, now with the new Reconfigurable Module variants. The routing is a mix of dashed (locked) and solid (new) routing segments, as shown below.

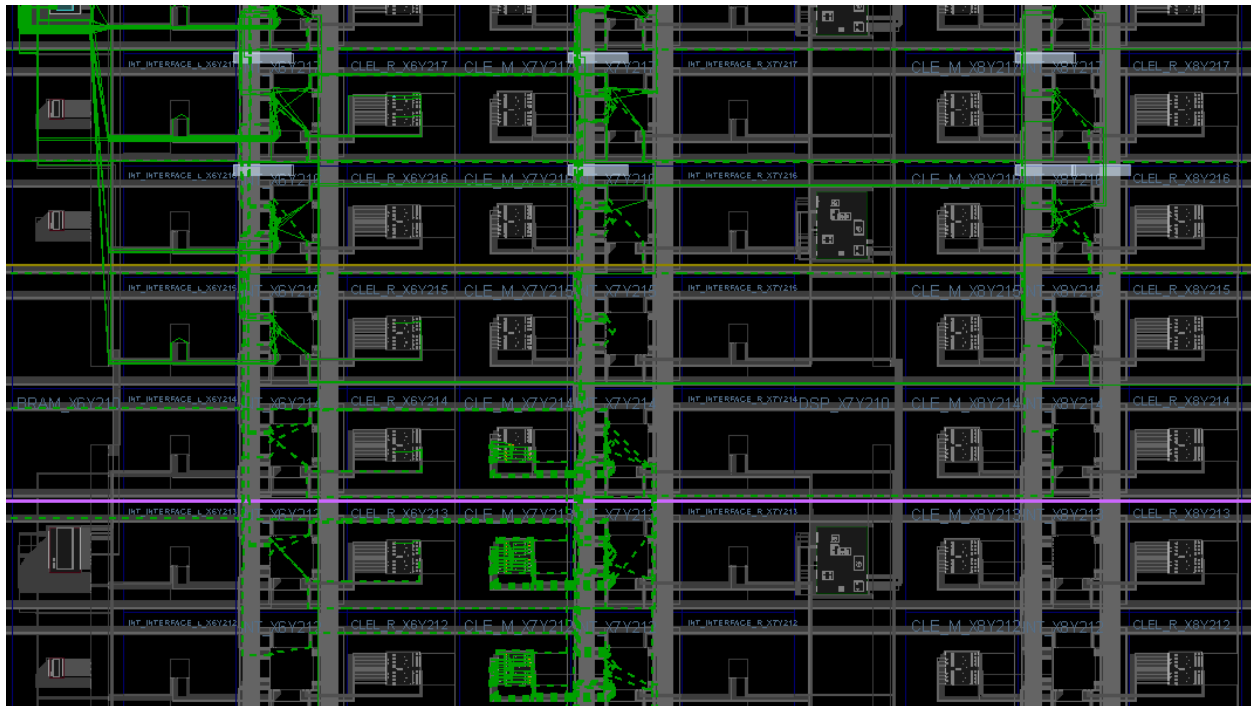

Figure 19: Second Configuration Routed, Showing Locked and New Routes

## Saving the Results

1. Save the full design checkpoint and report files by issuing these commands:

```
write_checkpoint -force
Implement/Config_shift_left_count_down_import/top_route_design.dcp

report_utilization -file
Implement/Config_shift_left_count_down_import/top_utilization.rpt

report_timing_summary -file
Implement/Config_shift_left_count_down_import/top_timing_summary.rpt
```

2. [Optional] Save checkpoints for each of the Reconfigurable Modules by issuing these two commands:

```
write_checkpoint -force\
-cell_inst_shift Checkpoint/shift_left_route_design.dcp

write_checkpoint -force\
-cell_inst_count Checkpoint/count_down_route_design.dcp
```

At this point, you have implemented the static design and all Reconfigurable Module variants. This process would be repeated for designs that have more than two Reconfigurable Modules per Reconfigurable Partition.

## Step 8: Examining the Results with Highlighting Scripts

With the routed configuration open in the IDE, run some visualization scripts to highlight tiles and nets. These scripts identify the resources allocated for partial reconfiguration, and are automatically generated. For UltraScale and UltraScale+ devices, there are different scripts to show the range for placement versus routing for a given Pblock.

1. In the Tcl Console, issue the following commands from the <Extract\_Dir> directory:

```
source hd_visual/pblock_inst_shift_Routing_AllTiles.tcl
highlight_objects -color green [get_selected_objects]
```

2. Click somewhere in the Device view to deselect the frames (or enter `unselect_objects`), then issue the following commands:

```
source hd_visual/pblock_inst_shift_Placement_AllTiles.tcl
source hd_visual/pblock_inst_count_Placement_AllTiles.tcl
highlight_objects -color blue [get_selected_objects]
```

The partition frames appear highlighted in the Device view, as shown in Figure 20.

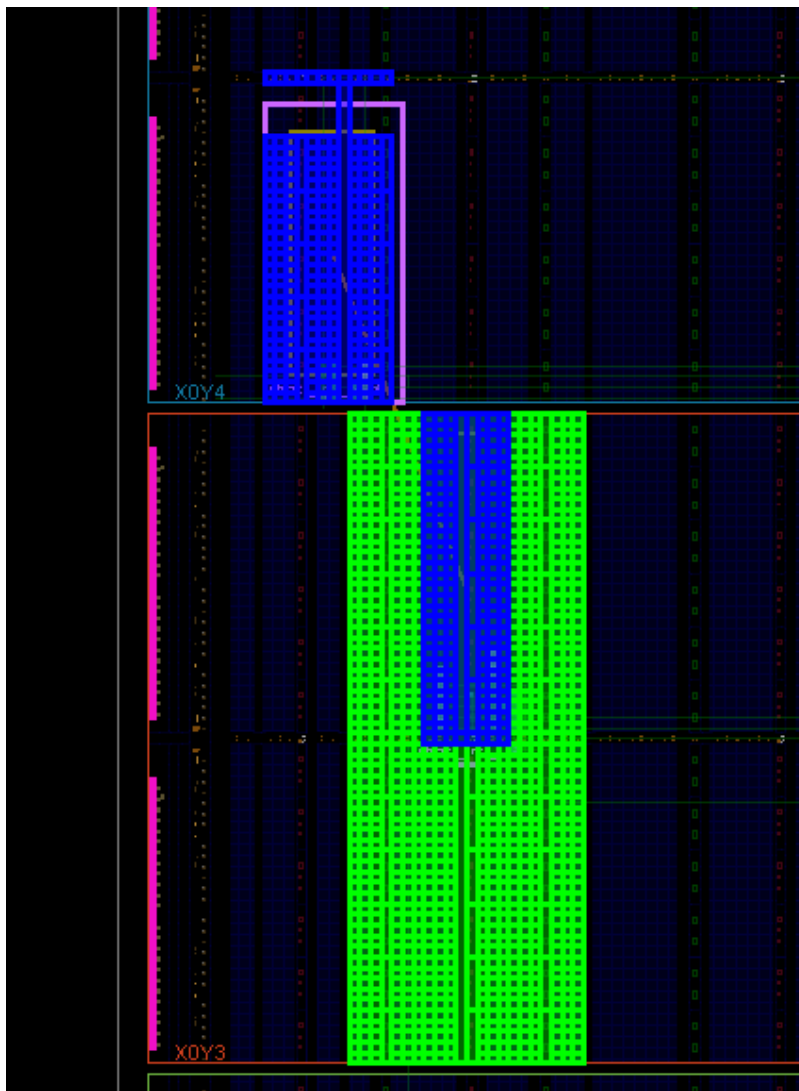

**Figure 20: Reconfigurable Partition Frames Highlighted**

These highlighted tiles represent the configuration frames used for placement (blue) and routing (green) for each RM. The green tiles are sent to bitstream generation to create the partial bitstream (for `inst_shift`). The `SNAPPING_MODE` feature adjusted three of four edges of `pblock_shift` to account for alignment to programmable unit boundaries. This snapping behavior explains why it appears that static logic may appear to have been placed inside Reconfigurable Partitions, as seen in Figure 17, Figure 18, and Figure 19. In actuality, the effective boundary is one CLB row higher than the user-defined Pblock boundary indicates, so this static logic is placed correctly. This effective boundary can also be seen in the shading of the Pblock during creation, as shown in Figure 12 and Figure 13.

Also note that RCLK rows matching the width of the Pblocks are included. Global clocks driving logic in these Reconfigurable Partitions are connected to the spines running through these rows and are enabled or disabled during partial reconfiguration.

The other “tile” scripts are variations on these. If you had not created Pblocks that vertically aligned to the clock region boundaries, the FrameTiles script would highlight the explicit Pblock tiles, while the AllTiles script extends those tiles to the full reconfigurable frame height. Note that these leave gaps where unselected frame types (for example: global clocks) exist.

The GlitchTiles script is a subset of frame sites, avoiding dedicated silicon resources; the other scripts are more informative than this one.

3. Close the current design:

```
close_project
```

---

## Step 9: Generating the Bitstreams

### Verifying the Configurations



**RECOMMENDED:** Before generating bitstreams, verify all configurations to ensure that the static portion of each configuration match identically, so the resulting bitstreams are safe to use in silicon. The PR Verify feature examines the complete static design up to and including the partition pins, confirming that they are identical. Placement and routing within the Reconfigurable Modules is not checked, as different module results are expected here.

1. Run the `pr_verify` command from the Tcl Console:

```
pr_verify\  
Implement/Config_shift_right_count_up_implement/top_route_design.dcp\  
Implement/Config_shift_left_count_down_import/top_route_design.dcp
```

If successful, this command returns the following message.

```
INFO: [Vivado 12-3253] PR_VERIFY: check points  
Implement/Config_shift_right_count_up/top_route_design.dcp and  
Implement/Config_shift_left_count_down/top_route_design.dcp are compatible
```

By default, only the first mismatch (if any) is reported. To see all mismatches, use the `-full_check` option.

### Generating Bitstreams

Now that the configurations have been verified, you can generate bitstreams and use them to target your selected demonstration board.

1. First, read the first configuration into memory:

```
open_checkpoint\  
Implement/Config_shift_right_count_up_implement/top_route_design.dcp
```



2. Generate full and partial bitstreams for this design. Be sure to keep the bit files in a unique directory related to the full design checkpoint from which they were created.

```
write_bitstream -force -file Bitstreams/Config_RightUp.bit
close_project
```

Notice that five bitstreams have been created:

- o Config\_RightUp.bit  
This is the power-up, full design bitstream.
- o Config\_RightUp\_pblock\_inst\_shift\_partial.bit  
This is the partial bit file for the shift\_right module.
- o Config\_RightUp\_pblock\_inst\_count\_partial.bit  
This is the partial bit file for the count\_up module.
- o Config\_RightUp\_pblock\_inst\_shift\_partial\_clear.bit  
This is the clearing bit file for the shift\_right module.
- o Config\_RightUp\_pblock\_inst\_count\_partial\_clear.bit  
This is the clearing bit file for the count\_up module.

---

**IMPORTANT:** When generated by a single call to `write_bitstream`, the names of the bit files currently do not reflect the name of the Reconfigurable Module variant to clarify which image is loaded. The current solution uses the base name given by the `-file` option and appends the Pblock name of the reconfigurable cell. It is critical to provide enough description in the base name to be able to identify the reconfigurable bit files clearly. All partial bit files have the `_partial` postfix, and all clearing bit files have the `_partial_clear` postfix.

---



Using `design_complete.tcl` to process the entire design through bitstream generation, uses a different technique for generating the bitstreams. Opening a routed design checkpoint issues multiple calls to `write_bitstream`, which gives you more control over naming bitstreams and allows for different options (such a bitstream compression) to be applied to full versus partial bitstreams. For example, the names selected in the full `design_complete.tcl` script are:

- o Config\_shift\_right\_count\_up\_implement\_full.bit  
This is the power-up, full design bitstream.
- o pblock\_shift\_shift\_right\_partial.bit  
This is the partial bit file for the shift\_right module.
- o pblock\_shift\_shift\_right\_partial\_clear.bit  
This is the clearing bit file for the shift\_right module.
- o pblock\_count\_count\_up\_partial.bit  
This is the partial bit file for the count\_up module.
- o pblock\_count\_count\_up\_partial\_clear.bit  
This is the clearing bit file for the count\_up module.

3. Generate full and partial bitstreams for the second configuration, again keeping the resulting bit files in the appropriate folder.

```
open_checkpoint\  
Implement/Config_shift_left_count_down_import/top_route_design.dcp  
  
write_bitstream -force -file Bitstreams/Config_LeftDown.bit  
  
close_project
```

Similarly, you see five bitstreams created, this time with a different base name.

4. Generate a full bitstream with grey boxes, plus blanking bitstreams for the Reconfigurable Modules. Blanking bitstreams can be used to “erase” an existing configuration to reduce power consumption.

**Note:** *Grey box blanking bitstreams are not the same as clearing bitstreams. Clearing bitstreams are required to prepare the global signal mask for the next partial bitstream, ensuring the GSR event occurs properly.*

```
open_checkpoint Checkpoint/static_route_design.dcp  
  
update_design -cell inst_count -buffer_ports  
update_design -cell inst_shift -buffer_ports  
  
place_design  
route_design  
  
write_checkpoint -force Checkpoint/config_grey_box.dcp  
write_bitstream -force -file Bitstreams/config_grey_box.bit  
  
close_project
```

The base configuration bitstream has no logic for either reconfigurable partition. The `update_design` commands here insert constant drivers (ground) for all outputs of the Reconfigurable Partitions, so these outputs do not float. The term *grey box* indicates that the modules are not completely empty with these LUTs inserted, as opposed to black boxes, which would have dangling nets in and out of this region. The `place_design` and `route_design` commands ensure they are completely implemented. As valid Reconfigurable Modules, note that these instances also have clearing bitstreams.

## Step 10: Partially Reconfiguring the FPGA

The `count_shift_led` design targets one of two demonstration boards. The current design supports the KCU105 and VCU108 boards, revisions Rev 1.0 and newer, with production silicon required.

### *Configuring the Device with a Full Image*

1. Connect the board to your computer using the Platform Cable USB and power on the board.
2. From the main Vivado IDE, select **Flow > Open Hardware Manager**.
3. Select **Open target** on the green banner. Follow the steps in the wizard to establish communication with the board.
4. Select **Program device** on the green banner and pick the target device, e.g. **xcku040\_0**.
5. Navigate to the Bitstreams folder to select `Config_RightUp.bit`, then click **OK** to program the device.

You should now see the bank of GPIO LEDs performing two tasks. Four LEDs are performing a counting-up function (MSB is on the left), and the other four are shifting to the right. Note the amount of time it took to configure the full device.

### *Partially Reconfiguring the Device*

At this point, you can partially reconfigure the active device with any of the partial bitstreams that you have created, starting first with the appropriate clearing bitstream.

1. Select **Program device** on the green banner again. Navigate to the `Bitstreams` folder to select `Config_RightUp_pblock_inst_shift_partial_clear.bit`, then click **OK** to program the device.

The shift portion of the LEDs stopped, but the counter kept counting up, unaffected by the reconfiguration. Note the much shorter configuration time, as well as the fact that the DONE LED turned off.

2. Select **Program device** on the green banner again. Navigate to the `Bitstreams` folder to select `Config_LeftDown_pblock_inst_shift_partial.bit`, then click **OK** to program the device.

The shift portion of the LEDs restarted in the opposite direction, and the DONE LED is back on.

3. Select **Program device** on the green banner again. Navigate to the `Bitstreams` folder to select `Config_RightUp_pblock_inst_count_partial_clear.bit`, then click **OK** to program the device.

The count portion of the LEDs stopped, but the shifter kept shifting, unaffected by the reconfiguration.

4. Select **Program device** on the green banner again. Navigate to the `Bitstreams` folder to select `Config_LeftDown_pblock_inst_count_partial.bit`, then click **OK** to program the device.

The counter is now counting down, and the shifting LEDs were unaffected by the reconfiguration. This process can be repeated with the `Config_RightUp` partial bit files to return to the original configuration, or with the blanking partial bit files to stop activity on the LEDs (they will stay on). Keep track of the currently loaded module for each partition to ensure the correct clearing bitstream is loaded before the next partial bitstream.

---

## Conclusion

This concludes lab 2. In this lab, you:

- Synthesized a design bottom-up to prepare for partial reconfiguration implementation
- Created a valid floorplan for a partial reconfiguration design
- Created two configurations with common static results
- Implemented these two configurations, saving the static design to be used in each
- Created checkpoints for static and reconfigurable modules for later reuse
- Examined framesets and verified the two configurations
- Created full, partial, and clearing bitstreams
- Configured and partially reconfigured an FPGA

---

### Section 1 – Setting up the Partial Reconfiguration design structure

In this section, you create a new project and set up all the sources and runs defining the structure of a PR design.

#### *Extracting the Tutorial Design Files*

1. To obtain the tutorial design file, see Tutorial Design Description.
2. Navigate to `\pr_project` in the extracted files. The `pr_project` data directory is referred to in this lab as the `<Extract_Dir>`.

#### *Load initial Design Sources*

The first unique step in any PR design flow (project based or otherwise) is to define the parts of the design that will be marked reconfigurable. This is done via context menus in the Hierarchical Source View in project mode. This section will step through initial project creation through definition of partitions in a simple design.

1. Extract the design from the archive. The `pr_project` data directory is referred to in this tutorial as the `<Extract_Dir>`.
2. Open the Vivado IDE and select **Create New Project**, then click **Next**.
3. Select the `<Extract_Dir>` as the **Project location**. Leave the **Project name** as `project_1`, then click **Next**.
4. Select **RTL Project** and ensure the **Do not specify sources** checkbox is unchecked, then click **Next**.
5. Click the Add Directories button and select these Sources directories to be added to the design:
  - o `<Extract_Dir>\Sources\hdl\top`
  - o `<Extract_Dir>\Sources\hdl\shift_right`
6. Click **Next** twice to get to the Add Constraints window, then select these files:
  - o `<Extract_Dir>\Sources\xdc\top_io_<board>.xdc`
  - o `<Extract_Dir>\Sources\xdc\pblocks_<board>.xdc`

Note that these constraint files are full design constraints, scoped to the top level design. If you would like to perform your own floorplanning, only select the `top_io` xdc, omitting the `Pblocks` xdc. Stop the flow after synthesis to create your own floorplan.

- Click **Next** to choose the part. In the Part selector, click on **Boards** and choose the target board matching the constraint file you have selected. Then click **Next** and then **Finish** to complete project creation. The Sources window shows a standard hierarchical view of the design

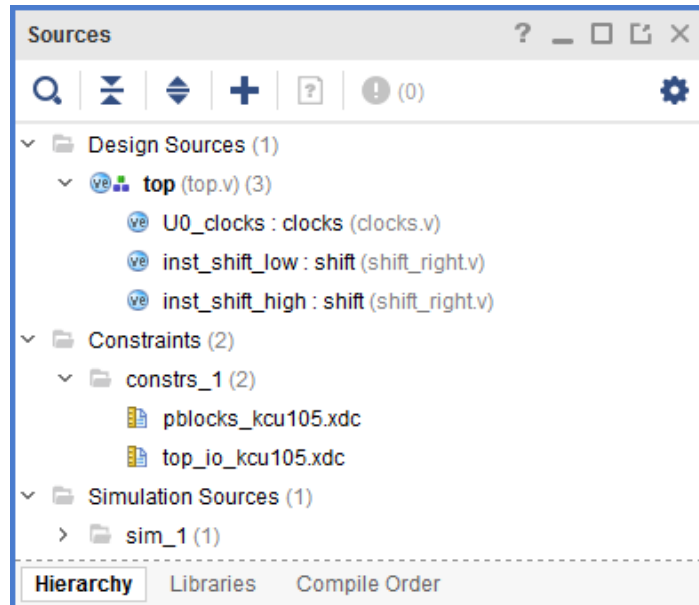
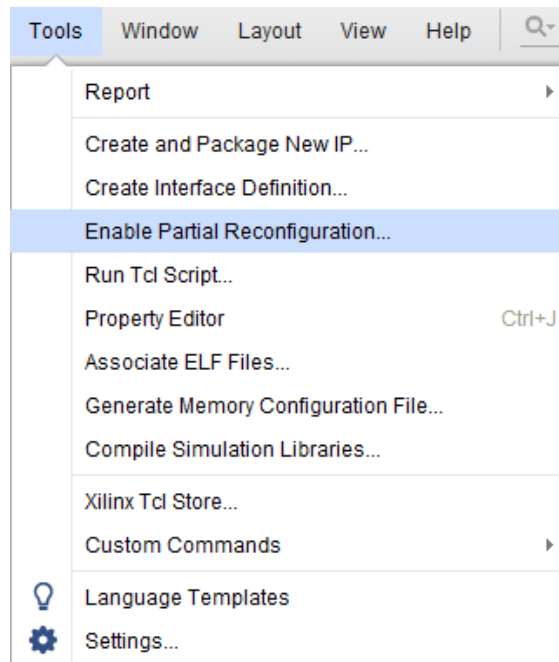

**Figure 21: Sources View After Project Creation**

At this point, a standard project is open. Nothing specific to Partial Reconfiguration has been done.

- Select **Tools > Enable Partial Reconfiguration**

This prepares the project for the PR design flow. Once this is set it cannot be undone, so archive your project before selecting this option.



**Figure 22: Enabling Partial Reconfiguration**

In the ensuing dialog box, click **Convert** to turn this project into a PR project.

9. Right-click on one of the “shift” instances and select the **Create Partition Definition...** option.

This action will define \*both\* shift instances as Reconfigurable Partitions in the design. Since each instance has come from the same RTL source, they are logically identical. Out-of-context synthesis will be run to keep this module separated from top, and the one post-synthesis checkpoint will be used for both shift instances.





---

**TIP:** *If there are multiple instantiations of the same module exist within a design, but not all need to be reconfigurable, then the modules must manually modified to become unique. Then you can independently tag desired instances as Reconfigurable Partitions.*

---

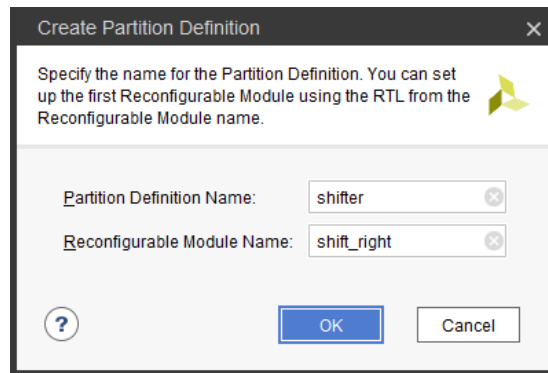
10. In the dialog box that appears, give names to both the Partition Definition and the Reconfigurable Module. The Partition Definition is the general reference for the workspace into which all Reconfigurable Modules will be inserted, so give it an appropriate name, such as `shifter`. The Reconfigurable Module refers to this specific RTL instance, so give it a name that references its functionality, such as `shift_right`, then click **OK**.



**Figure 23: Creating the `shifter` Partition Definition**

The **Sources** view has now changed slightly, with both shift instances now shown with a yellow diamond, indicating they are Partitions. You will also see a **Partition Definitions** tab in this window, showing the list and contents of all Partition Definitions (just one at this point) in the design. In addition, an out-of-context module run has been created for synthesizing the `shift_right` module.

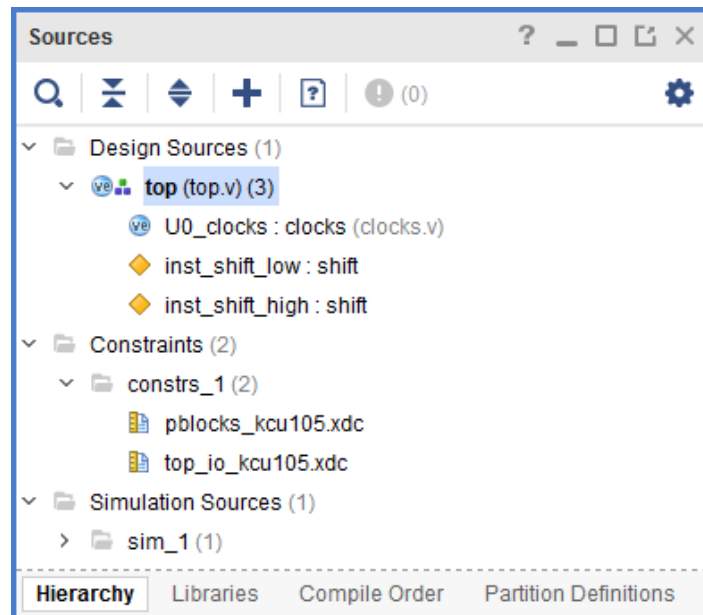

**Figure 24: Sources view after shift partition has been defined**

At this point, more Reconfigurable Module sources may be added. This is done via the Partial Reconfiguration Wizard.



**IMPORTANT:** After Partitions have been defined, all additional RMs must be added via the Partial Reconfiguration Wizard, and any management of RM sources, configurations, and runs must also be done via this wizard.



## Use the Partial Reconfiguration Wizard to complete the rest of the design

1. Launch the **Partial Reconfiguration Wizard** by selecting this option under the Tools menu or from the Flow Navigator.
2. Click **Next** to get to the **Edit Reconfigurable Modules** page. Here you can see the `shift_right` RM already exists, and there are add, remove and edit buttons on the left hand side of the page. Click on the green + icon to add a new RM.
3. Click the Add Directories button to select the `shift_left` folder:

```
<Extract_Dir>\Sources\hdl\shift_left
```

Or use the **Add Files** button to select the `shift_left.v` file residing in this directory. If module-level constraints were needed, they would be added here. Note that they would need to be scoped to the level of hierarchy for this Partition.

Fill in the Reconfigurable Module field to be `shift_left`. Set the Partition Definition to be `shifter`, leave **Top Module** field empty and the **Sources are already synthesized** check box unchecked. Click **OK** to create the new module.

Two Reconfigurable Modules are now available for the `shifter` Reconfigurable Partition.

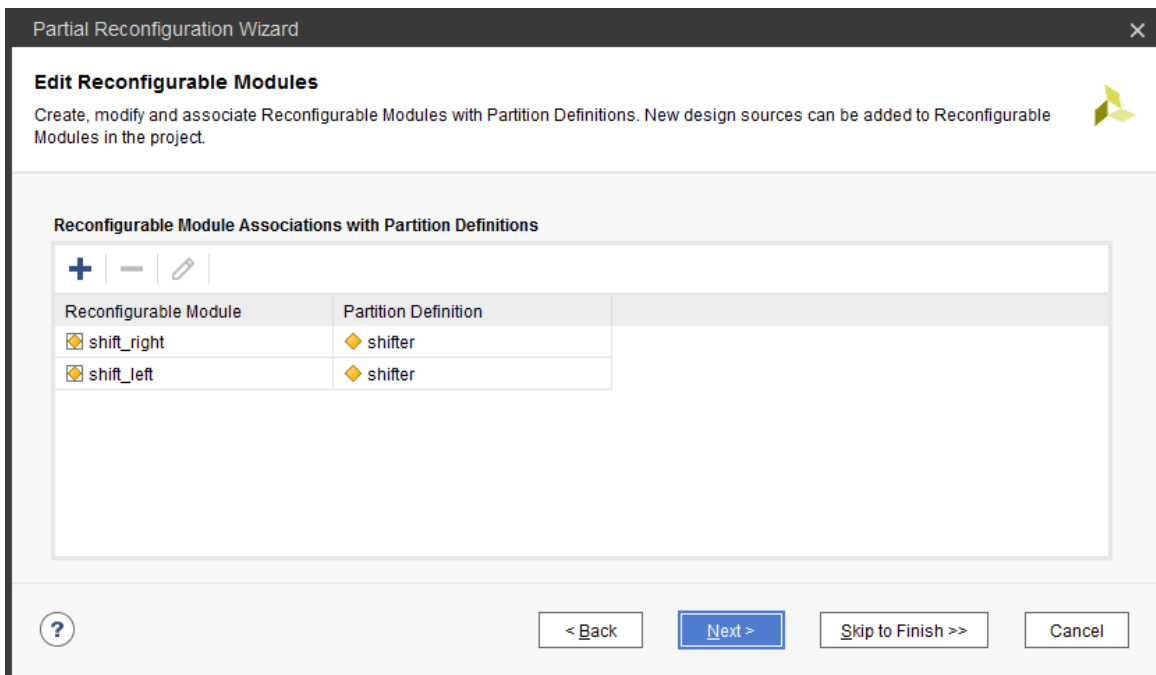

**Figure 25: Partial Reconfiguration Wizard with two Reconfigurable Modules defined**

On the next page, **Configurations** are defined. Configurations are full design images consisting of the static design and one RM per RP. You can either create any desired set of configurations, or simply let the wizard select them for you.

4. Let the Wizard create the configurations by selecting the **automatically create configurations** link.

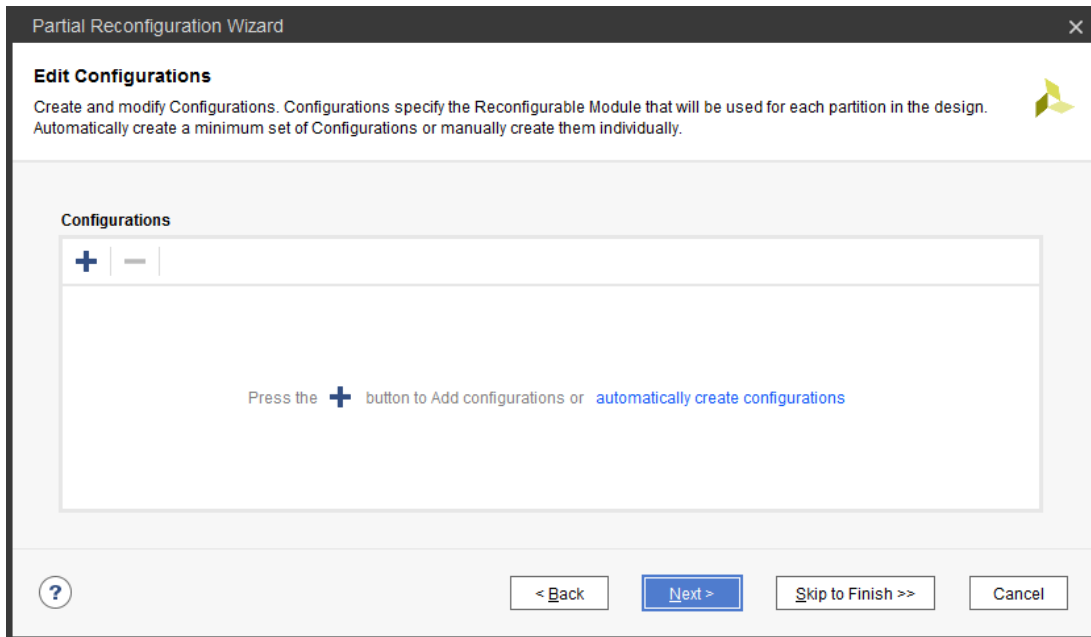

**Figure 26: Partial Reconfiguration Wizard Configurations page**

After selecting this option, the minimum set of two configurations has been created. Each shift instance has been given **shift\_right** in the first configuration and **shift\_left** in the second configuration. Note that the **Configuration Name** is editable – in the example below, the names have been updated to **config\_right** and **config\_left** to reflect the Reconfigurable Modules contained within each one.

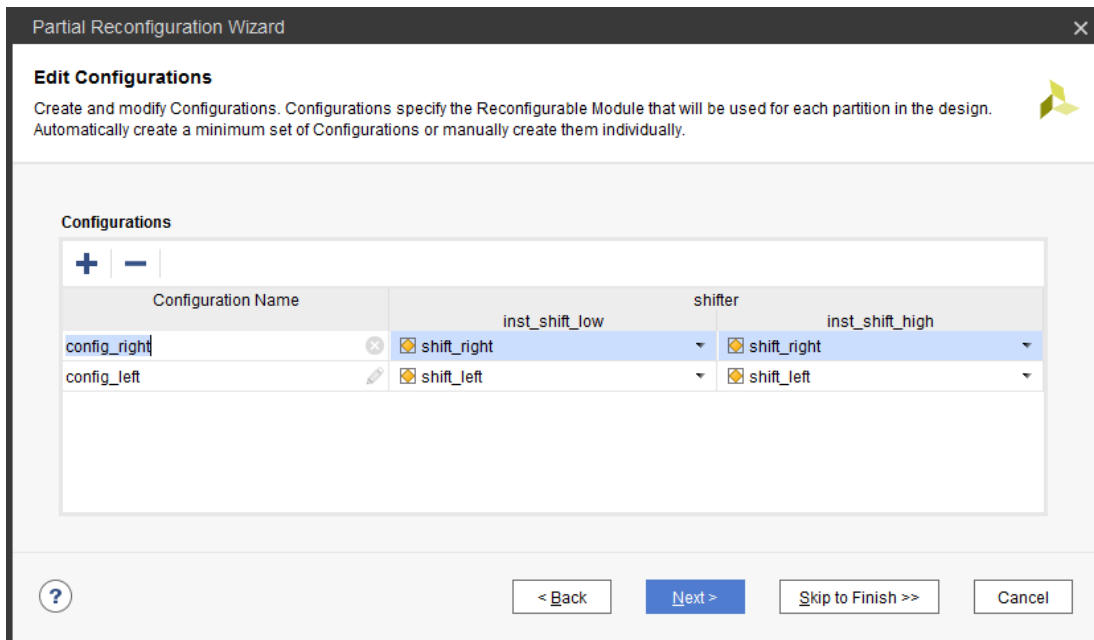

**Figure 27: Auto-Generated minimum set of Configurations**

Additional configurations can be created by using these two Reconfigurable Modules, but two is all you need to create all the partial bitstreams necessary for this version of the design, as the maximum number of RMs for any RP is two.

5. Click **Next** to get to the **Edit Configuration Runs** page.

As with configurations themselves, the runs used to implement each configuration can be automatically or manually created. A parent-child relationship will define how the runs interact – the parent run implements the static design and all RMs within that configuration, then child runs reuse the locked static design while implementing the RMs within that configuration in that established context.

6. Click on the **automatically create configuration run** link to populate the Configuration Runs page with the minimum set of runs.

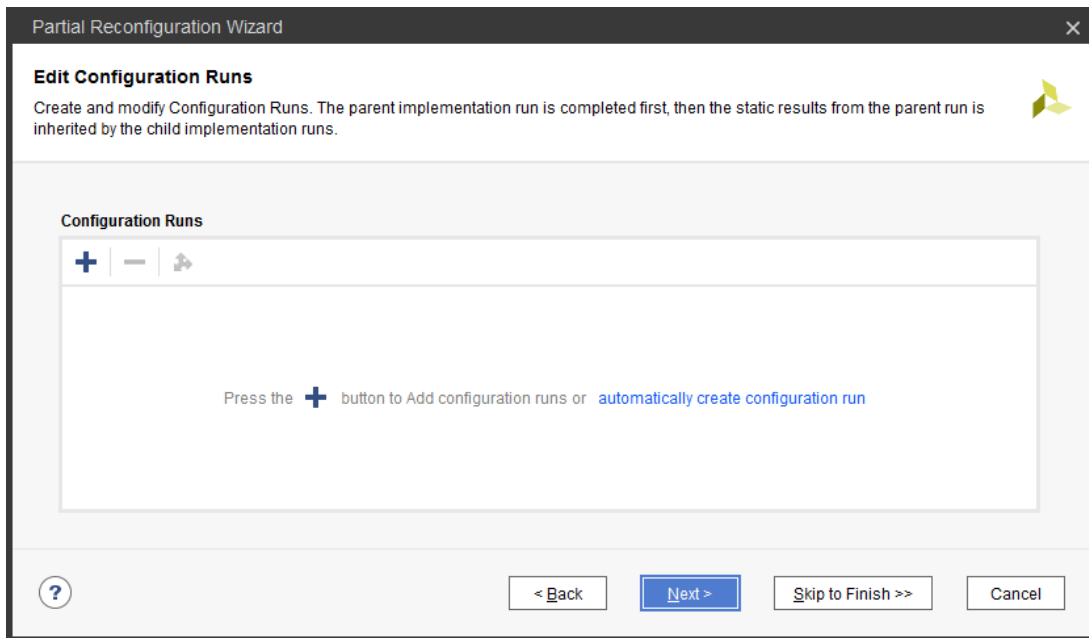

Figure 28: Partial Reconfiguration Wizard

This creates two runs, consisting of one parent configuration (**config\_right**) and one child configuration (**config\_left**). Any number of independent or related runs can be created within this wizard, with options for using different strategies or constraint sets for any of them. For now, leave this set to the two runs set here. Note that the names of the runs are not editable.

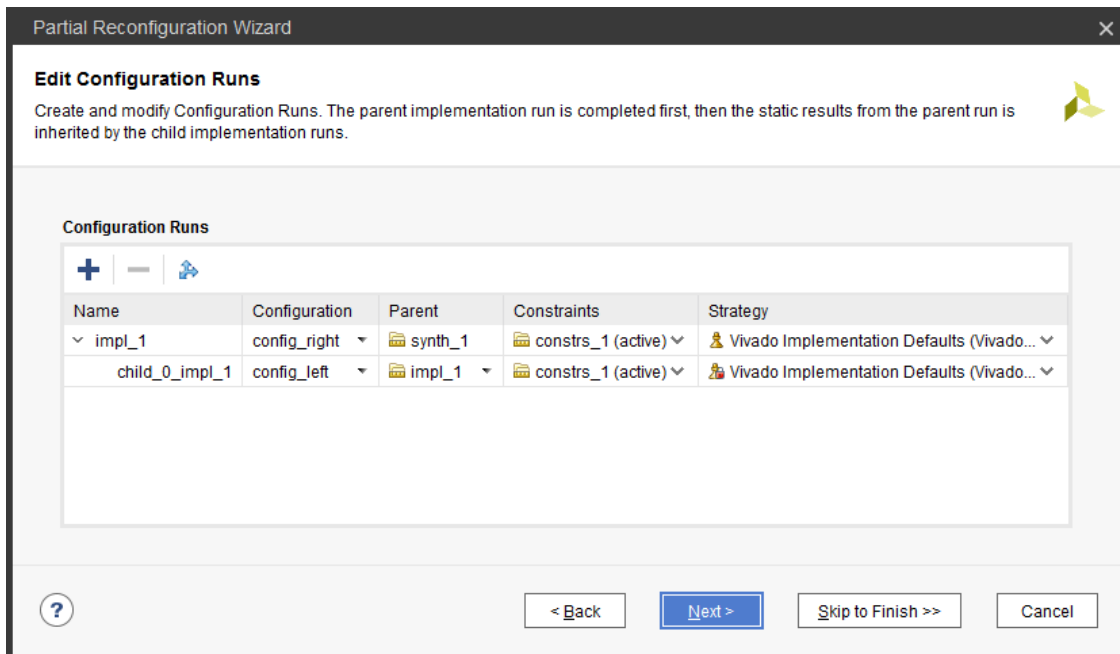

Figure 29: Auto-generated Minimum set of Configuration Runs

- Click **Next** to see the Summary page then Finish to complete the design setup and exit the Wizard.



**IMPORTANT:** *Nothing is created or modified until you click Finish to exit the Partial Reconfiguration Wizard. All actions are queued until this last click, so it is possible to step forward and back as needed without implementing changes until you are ready.*

Back in the Vivado IDE, you will see that the **Design Runs** window has been updated. A second out-of-context synthesis run has been added for the **shift\_left** RM, and a child implementation run (**child\_0\_impl\_1**) has been created under the parent (**impl\_1**). You are now ready to process the design.

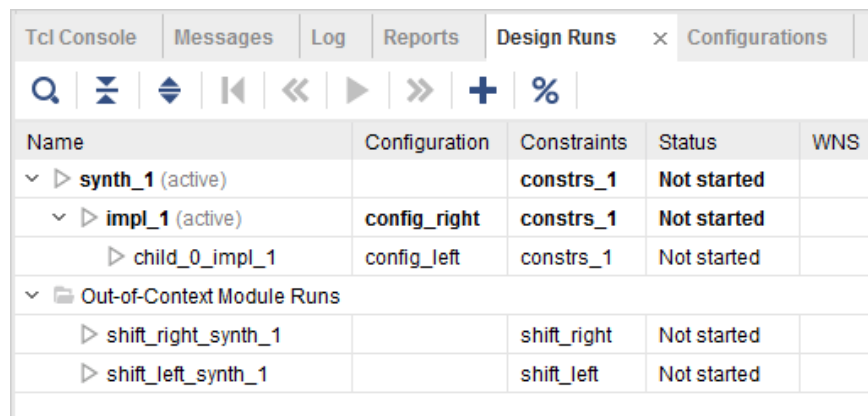

Name	Configuration	Constraints	Status	WNS
▼ ▶ synth_1 (active)		constrs_1	Not started	
▼ ▶ impl_1 (active)	config_right	constrs_1	Not started	
▶ child_0_impl_1	config_left	constrs_1	Not started	
▼ Out-of-Context Module Runs				
▶ shift_right_synth_1		shift_right	Not started	
▶ shift_left_synth_1		shift_left	Not started	

Figure 30: Design Runs window showing all synthesis and implementation ready to launch

## Conclusion

Reconfigurable Partitions are first defined from within the hierarchical source view in the Vivado IDE, then all manipulation of Reconfigurable Modules, Configurations and Design Runs are done within the Partial Reconfiguration Wizard.

## Section 2 – Managing Design Runs

In this section, you will launch synthesis and implementation runs, compiling the design from RTL to bitstream. You will also stop along the way to view the design floorplan and run PR-specific design rule checks.

### Synthesize and Implement the current design

With the design from section one open in the Vivado IDE, take a look at the **Design Runs** window. The top-level design synthesis run (synth\_1) and the parent implementation run (impl\_1) are marked “active.” The Flow Navigator actions apply to these active runs, so clicking on **Run Synthesis** or **Run Implementation** will pull the design through only these runs, as well as the OOC synthesis runs needed to complete them. You could select the child implementation

run, right-click and select **Launch Runs** to pull through the entire flow. But synthesis is run separately below.

1. In the Flow Navigator, click **Run Synthesis**. When synthesis completes, select **Open Synthesized Design**.

This action will synthesize all OOC modules, followed by synthesis of the top level design. This is no different than any design with OOC modules (IP or otherwise).

In the post-synthesis design that opens, note that two Pblocks have already been defined. These were supplied in `pblocks_<board>.xdc` and map to the two shift instances in top. If no Pblocks had existed with the design sources, they could be created at this step in the flow. This can be done by right-clicking on an `inst_shift` instance in the design hierarchy to select **Floorplanning > Draw Pblock**. Each instance will require its own unique Pblock.

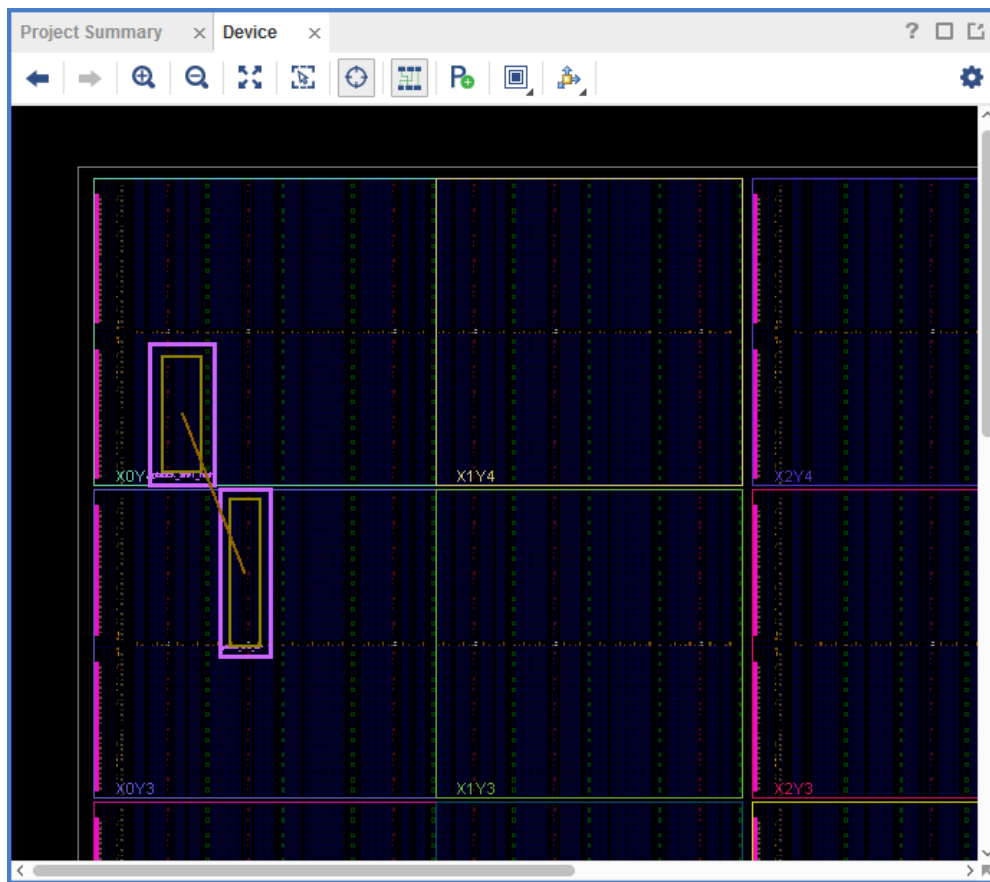

**Figure 31: Floorplan with two Reconfigurable Partitions (KC105 shown)**

2. Select one of the two Pblocks in the floorplan and note its properties. The last two properties listed are `RESET_AFTER_RECONFIG` (7 series only) and `SNAPPING_MODE`, two properties specific to Partial Reconfiguration. Note that both of these options have been enabled in the Pblocks xdc.

- Run PR-specific design rule checks by selecting **Tools > Report > Report DRC**. To save time, you can deselect all checkboxes other than the one for Partial Reconfiguration.

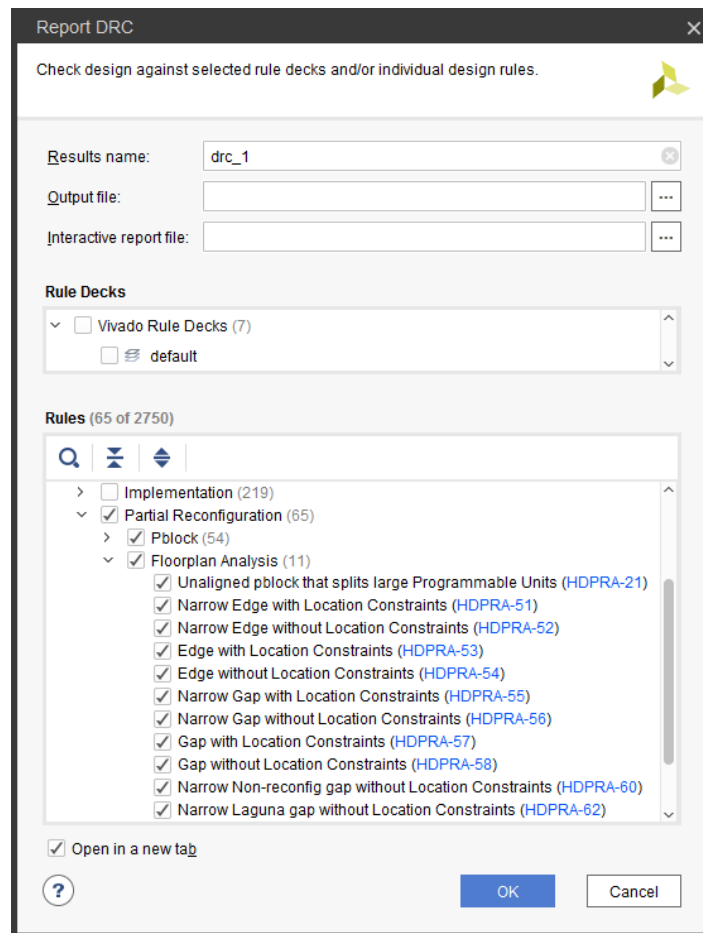

**Figure 32: Checking Partial Reconfiguration DRCs**

DRC checks will report no errors with the supplied sources and constraints. Advisory messages may be given for certain devices with suggestions on how to improve the quality of the given Pblocks. These can be ignored for this simple design.

If you have created your own floorplan and DRCs have been reported, fix the issues before moving on. Note that both modules will require BRAM resources, and remember that SNAPPING\_MODE will resolve any errors related to horizontal or vertical alignment.



**TIP:** Run Partial Reconfiguration Design Rule Checks early and often.

- In the Flow Navigator, select **Run Implementation** to run place and route on all configurations.

This action runs implementation first for impl\_1 and then for child\_0\_impl\_1. Behind the scenes, Vivado takes care of all the details. In addition to running place and route for the two

runs with all the PR requirements in place, it does a few more tasks specific to PR. After impl\_1 completes, Vivado automatically:

- Writes module-level (OOC) checkpoints for each routed shift\_right RM.
  - In a future release, these checkpoints can be used to create new configurations by mixing and matching RMs.
- Carves out the logic in each RP to create a static-only design image. This is done by calling update\_design –black\_box for each instance.
- Locks all placement and routing for this static-only design. This is done by calling lock\_design –level routing.
- Saves this locked static parent image to be reused for all child runs.

In addition, when the child run completes, module-level checkpoints are created for the routed shift\_left RMs. A locked static design image would be identical to the parent, so this step is not necessary.

If only specific configuration runs are desired, these can be individually selected within the Design Runs window. Note that a parent run must be completed successfully before a child run can be launched, as the child run starts with the locked static design from the parent.

5. When Implementation completes, click **Cancel** in the resulting pop-up dialog.



**CAUTION!** Even though the design has been processed through to the child implementation run, selecting “Open Implemented Design” opens the parent run, as that design is one defined as active.

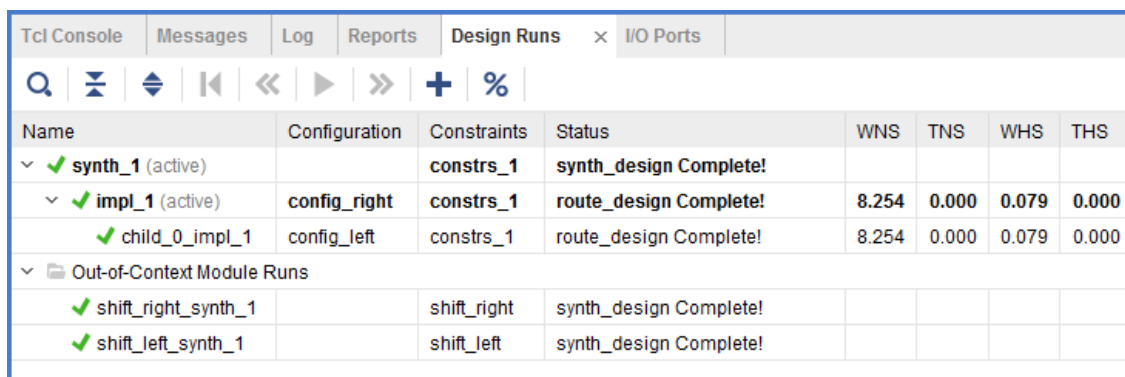

Name	Configuration	Constraints	Status	WNS	TNS	WHS	THS
✓ synth_1 (active)		constrs_1	synth_design Complete!				
✓ impl_1 (active)	config_right	constrs_1	route_design Complete!	8.254	0.000	0.079	0.000
✓ child_0_impl_1	config_left	constrs_1	route_design Complete!	8.254	0.000	0.079	0.000
Out-of-Context Module Runs							
✓ shift_right_synth_1		shift_right	synth_design Complete!				
✓ shift_left_synth_1		shift_left	synth_design Complete!				

Figure 33: All Configurations Routed

At this point, there are two steps remaining. The first is running PR Verify to compare the two configurations to ensure consistency of the static part of the design images. This step is highly recommended and will occur automatically within the Vivado project. The second step is to generate the bitstreams themselves.

6. In the Flow Navigator, click **Generate Bitstream**. This action launches bitstream generation on the active parent run, and launches PR Verify and then bitstream generation on all implemented child runs.



Note that by default a full design bitstream is generated for the parent configuration only. This may not be the configuration that is desired for power-on configuration. If a full device bitstream is desired for a child run, a property can be set to enable this capability:

```
set_property GEN_FULL_BITSTREAM 1 [get_runs <child_run_name>]
```

Currently, `write_bitstream` has two options that can be manually called to control these details: the `-cell` option requests that only a specific partial bitstream is created, and the `-no_partial_bitfile` option requests only the full design configuration image. For more information on `write_bitstream` options, see *Vivado Design Suite User Guide: Partial Reconfiguration* ([UG909](#)).

## Conclusion

The entire Partial Reconfiguration flow can now be run in a project environment. All steps, from module-level synthesis to bitstream generation can be done without leaving the GUI.

---

## Section 3 – Iterating on a Partial Reconfiguration design

In this section, you add new Reconfigurable Modules and revisit steps in the project flow.

### ***Add an additional Reconfigurable Module and corresponding Configuration***

1. With the design open in the Vivado IDE, open the **Partial Reconfiguration Wizard**.
2. On the **Edit Reconfigurable Modules** page, click the + button to add a new RM.
3. Select the `shift_right_slow.v` file in `<Extract_Dir>\Sources\hdl\shift_right_slow` then click **OK** and **Next**.

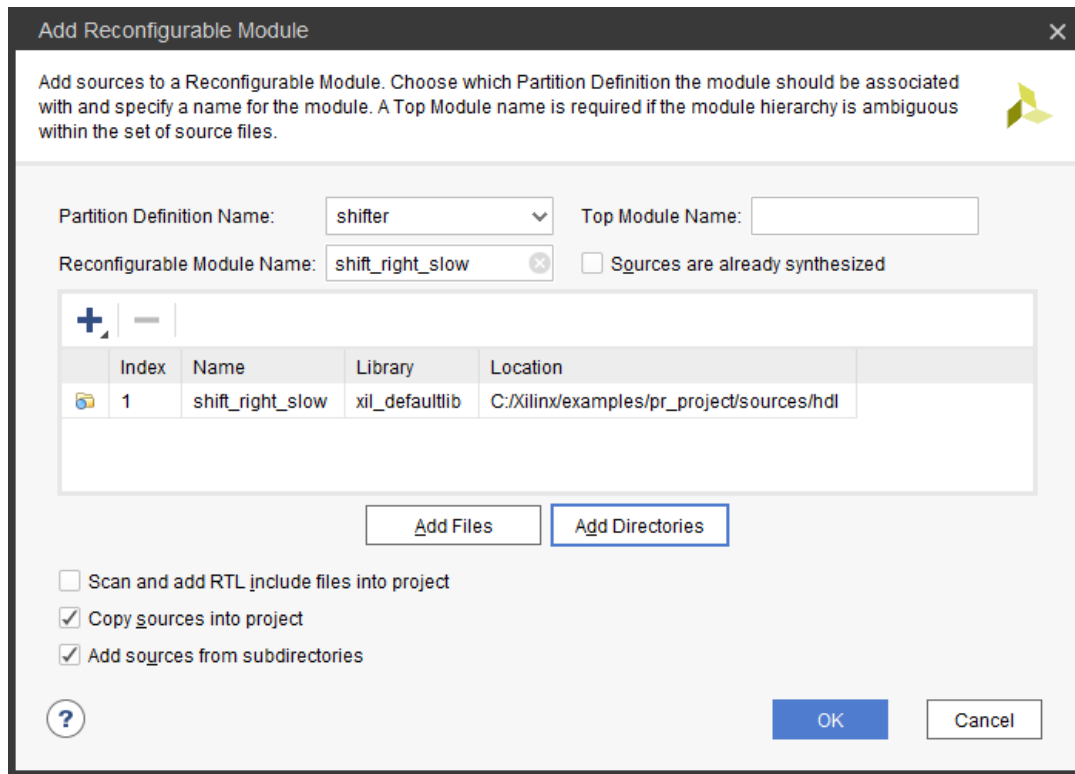

**Figure 34: Adding a new RM shift\_right\_slow**

Note that on the Edit Configurations page, there is no longer an option to automatically create configurations, as you already have two existing ones. You can re-enable this option by removing all existing configurations, but this will recreate all configurations and remove all existing results.

4. Create a new configuration by clicking the + button, entering the name **config\_right\_slow**, then hitting ENTER. Select **shift\_right\_slow** for each Reconfigurable Partition instance.

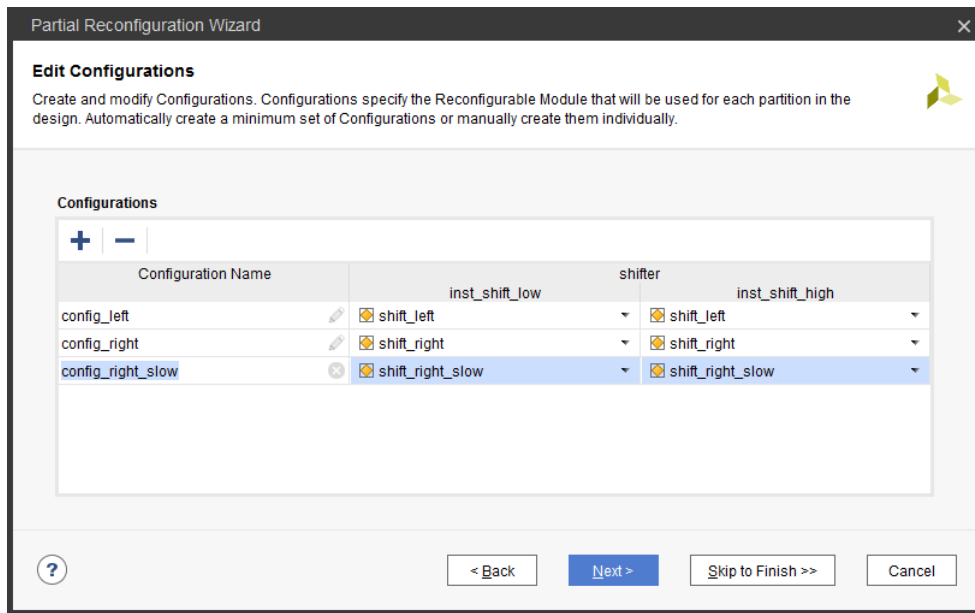

**Figure 35: Creating the config\_right\_slow Configuration**

5. Click **Next** to advance to the Configuration Runs. Use the + button to create a new configuration with these properties:
  - Run: child\_1\_impl\_1 – this simply matches the existing convention
  - Parent: impl\_1 – this makes this configuration a child run of the existing parent run
  - Configuration: config\_right\_slow – this is the one with the new RMs that was just defined
6. Click **OK** to add the new Configuration Run.

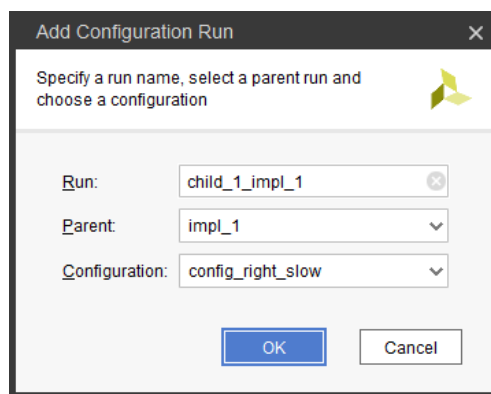

**Figure 36: Creating a new Configuration Run**

This new configuration, as a child of the existing impl\_1, will reuse the static design implementation results, just like config\_left did. Three runs now exist, with two as children of the initial parent. The green check marks indicate that two of the runs are currently complete.

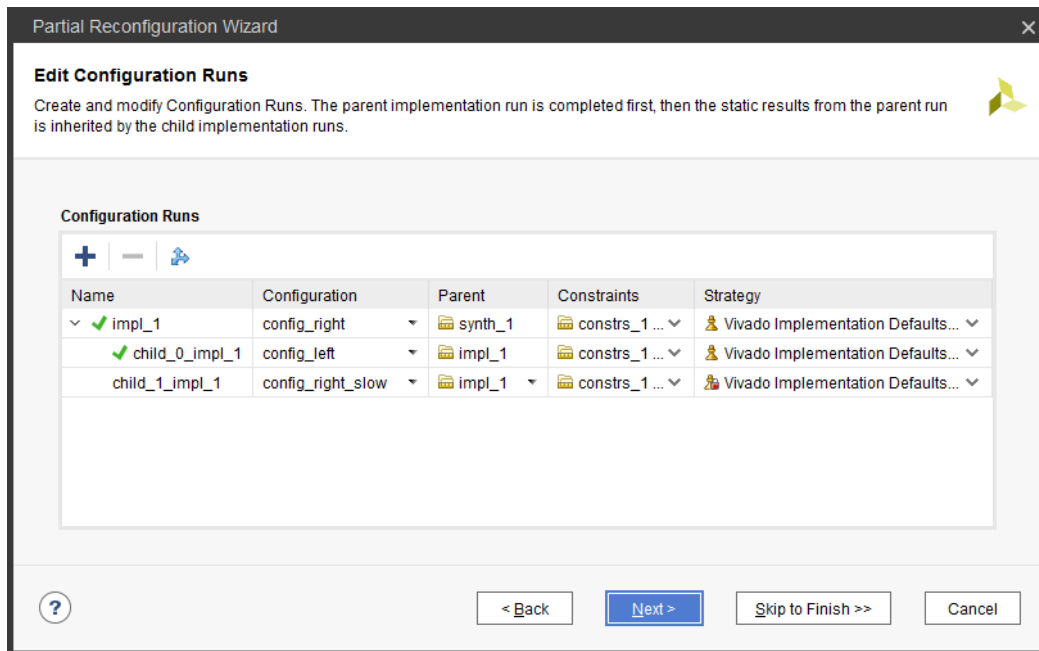

Figure 37: The config\_right\_slow configuration added as a new child run

- Click **Next**, then **Finish** to build this new configuration run.

Name	Configuration	Constraints	Status	WNS	TNS	WHS	THS
✓ synth_1 (active)		constrs_1	synth_design Complete!				
✓ impl_1 (active)	config_right	constrs_1	route_design Complete!	8.254	0.000	0.079	0.000
✓ child_0_impl_1	config_left	constrs_1	route_design Complete!	8.254	0.000	0.079	0.000
▶ child_1_impl_1	config_right_slow	constrs_1	Not started				
Out-of-Context Module Runs							
✓ shift_right_synth_1		shift_right	synth_design Complete!				
✓ shift_left_synth_1		shift_left	synth_design Complete!				
▶ shift_right_slow_synth_1		shift_right_slow	Not started				

Figure 38: New OOC synthesis run and Configuration run added

- Select this new child implementation run, right-click and select **Launch Runs** or select **Run Implementation** from the Flow Navigator. This will run OOC synthesis on the shift\_right\_slow module, then will implement this module within the context of the locked static design.

## Create and Implement a Greybox Module

For some designs, it may not be clear which Reconfigurable Module is the most difficult to implement. Or perhaps there are no Reconfigurable Modules available. A greybox implementation can be used to implement just the static design without real RM netlists available.

A greybox is a module that starts off as a blackbox, but then has LUTs automatically inserted for all ports. Output ports are driven to a logic 0 (by default, 1 is selectable via property) so they do not float. This module allows the design to be processed even if no RMs are available. Training scripts are available to create timing budgets for this greybox image, optimizing the implementation results of the static design. A configuration with greybox RMs can be the parent run, but this is only recommended when no other RMs exist and/or when budgeting constraints are used to optimize the RP interface placement.

- Open the Partial Reconfiguration Wizard and move to the Configurations page – no new Reconfigurable Modules need to be defined in this case. Create a new configuration a name of **config\_greybox** and enter `<greybox>` for each Reconfigurable Partition instance.

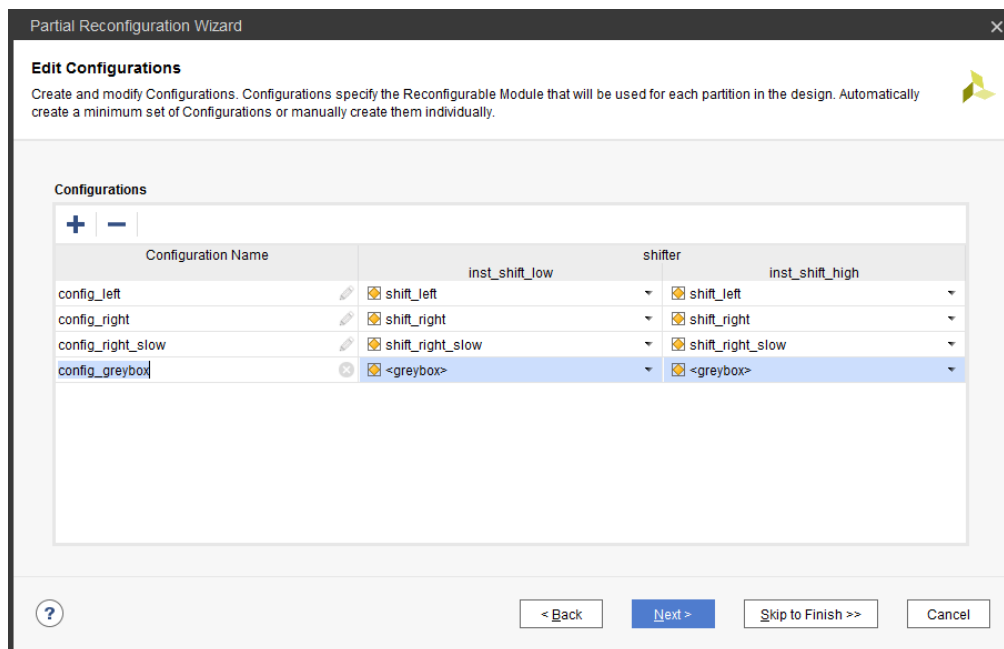
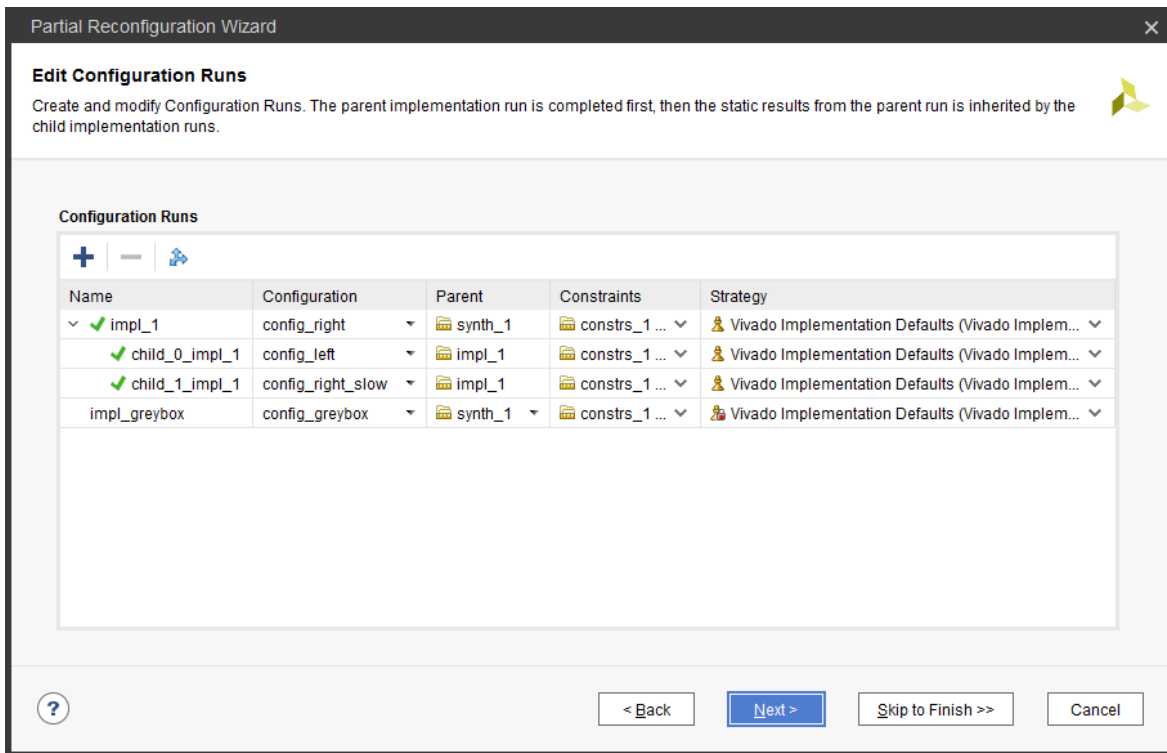

Figure 39: Adding the new config\_greybox Configuration

- Click **Next** to get to the Configuration Runs page, then create another new configuration run, this time for the greybox configuration.
  - Parent: synth\_1 – this makes this configuration a new parent, starting from the synthesized top level design
  - Configuration: config\_greybox – the RMs consist only of LUT tie-offs
  - Run: impl\_greybox



**Figure 40: Creating an independent greybox Configuration Run**

At this point, four configuration runs have been defined. Two are parents, and two are children of the first parent.

11. Click **Next** then **Finish** to create this new run.

Now there are four implementation runs and three out-of-context runs shown in the Design Runs window. Note that the greybox module does not require synthesis – it is an embedded feature in the PR solution.

Name	Configuration	Constraints	Status	WNS	TNS	WHS	THS
✓ synth_1 (active)		constrs_1	synth_design Complete!				
✓ impl_1 (active)	config_right	constrs_1	route_design Complete!	8.254	0.000	0.079	0.000
✓ child_0_impl_1	config_left	constrs_1	route_design Complete!	8.254	0.000	0.079	0.000
✓ child_1_impl_1	config_right_slow	constrs_1	route_design Complete!	8.254	0.000	0.079	0.000
▶ impl_greybox	config_greybox	constrs_1	Not started				
Out-of-Context Module Runs							
✓ shift_right_synth_1		shift_right	synth_design Complete!				
✓ shift_left_synth_1		shift_left	synth_design Complete!				
✓ shift_right_slow_synth_1		shift_right_slow	synth_design Complete!				

**Figure 41: Greybox Implementation Ready to Run**

At this point the greybox configuration can be implemented.

12. Select the **impl\_greybox** design run, right-click and select **Launch Runs**. The Flow Navigator will not launch this run as it is not the active parent.



---

**IMPORTANT:** Because *impl\_1* and *impl\_greybox* are both parents, their static design results will be different, and their resulting bitstreams will **NOT** be compatible in hardware. Only bitstreams derived from a single parent (and subsequently confirmed using PR Verify) should ever be delivered via PR to a device.

---

## Modify a design source or options

The Vivado IDE tracks dependencies between design runs. This is a critical feature for Partial Reconfiguration given the interdependencies of configurations. If any aspect of the parent configuration or implementation results are modified, it and all children must be recompiled.

1. Select the **impl\_1 design** run.
2. In the Options tab of the Run Properties window, change the Strategy to **Performance\_Explore**.

A pop-up dialog will alert you to the fact that *impl\_1* will be forced out of date if you proceed.

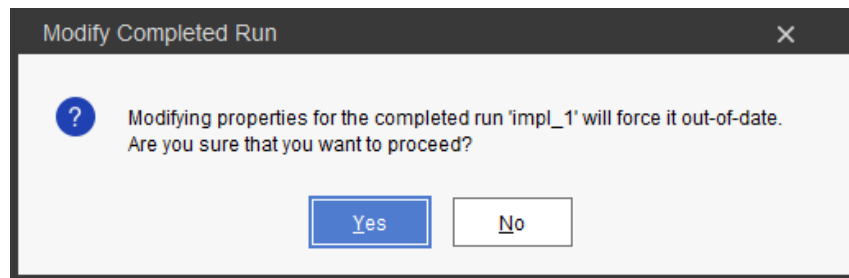
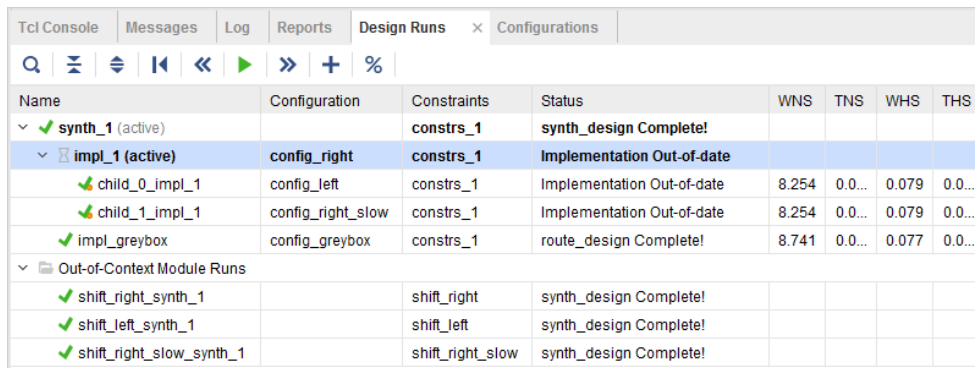

Figure 42: Modifying a Completed Run

3. Click **Yes**.

Multiple runs are now marked out-of-date: *impl\_1* and both child runs that depend on it. The resulting files still exist in their respective folders, but will be deleted as soon as the parent run is launched. The *impl\_greybox* design run, on the other hand, remains completed as it does not depend on *impl\_1* as a parent.

Note that the Strategy option for each of the child runs remains at **Vivado Implementation Defaults**; child runs do not inherit options from the parent run. However, any strategy or option in child runs will only have an effect on the Reconfigurable Module implementation, as the static design is already routed and locked.



Name	Configuration	Constraints	Status	WNS	TNS	WHS	THS
✓ synth_1 (active)		constrs_1	synth_design Complete!				
✗ impl_1 (active)	config_right	constrs_1	Implementation Out-of-date				
✗ child_0_impl_1	config_left	constrs_1	Implementation Out-of-date	8.254	0.0...	0.079	0.0...
✗ child_1_impl_1	config_right_slow	constrs_1	Implementation Out-of-date	8.254	0.0...	0.079	0.0...
✓ impl_greybox	config_greybox	constrs_1	route_design Complete!	8.741	0.0...	0.077	0.0...
Out-of-Context Module Runs							
✓ shift_right_synth_1		shift_right	synth_design Complete!				
✓ shift_left_synth_1		shift_left	synth_design Complete!				
✓ shift_right_slow_synth_1		shift_right_slow	synth_design Complete!				

Figure 43: Design runs reset after parent modification

- In the Flow Navigator click **Run Implementation**.

This implements all three runs. First, the parent impl\_1 run will complete, then the two child runs will run in parallel.

### Conclusion

The Partial Reconfiguration Project Flow allows a great deal of flexibility, enabling users to manage their design environment and explore different options. Users must remain careful to track implementation results and bitstreams to ensure that only compatible bitstreams, built from a single fixed static image, are downloaded to the target device.



### Overview

This lab covers new features in Vivado 2017.1 for the Partial Reconfiguration (PR) solution. The following topics are covered in this lab:

- The Partial Reconfiguration project flow in the Vivado IDE
- Current IP support within Reconfigurable Modules (RM)
- Inserting Vivado Debug cores within Reconfigurable Modules
- Improvements to reporting unique to Partial Reconfiguration
- Debugging within the Vivado Hardware Manager

It differs from the PR flow in Lab 3 in that while this Project Flow is missing greybox implementation and a few other features, it covers IP and debugging. This lab supports only the KCU105 board.

---

### Section 1 – Set up the Partial Reconfiguration design

In this section, you create a new project and set up all the sources and runs defining the structure of a PR design.

#### *Load initial Design Sources*

The first unique step in any PR design flow (project based or otherwise) is to define the parts of the design to be marked as reconfigurable. This is done via context menus in the Hierarchical Source View in project mode. This section steps through initial project creation to definition of partitions in a simple design.

1. Extract the design from the TSC archive. The `pr_project` data directory is referred to in this tutorial as the `<Extract_Dir>`.
2. Open the Vivado IDE and select **Create Project**, then click **Next**.
3. Select the `<Extract_Dir>` as the **Project location**. Leave the **Project name** as `project_1`, then click **Next**.
4. Select **RTL Project** and ensure the **Do not specify sources** checkbox is unchecked, then click **Next**.

5. Click the **Add Files** button and select these sources to add to the design:

- o <Extract\_Dir>\Sources\hdl\top.v
- o <Extract\_Dir>\Sources\hdl\mult.v
- o <Extract\_Dir>\Sources\ip\clk\_wiz\_0.xci
- o <Extract\_Dir>\Sources\ip\vio\_0.xci

Do not select add.v or mult\_no\_ila.v, as these are the sources for RMs that will be added later.

6. Select the **Copy sources into project** checkbox

7. Click **Next** to get to the Add Constraints window, then select the following file:

<Extract\_Dir>\Sources\xdc\top\_io\_kcu105.xdc

8. Select the Copy constraints files into project checkbox

**Note:** These constraint files are full design constraints, scoped to the top level design. This constraint file does not include a floorplan.

9. Click **Next** to choose the part. In the Part selector, click on **Parts** and (using filters if needed) choose the **xcku040-ffva1156-2-e**.

10. Then click **Next** and then **Finish** to complete project creation. The Sources window shows a standard hierarchical view of the design.

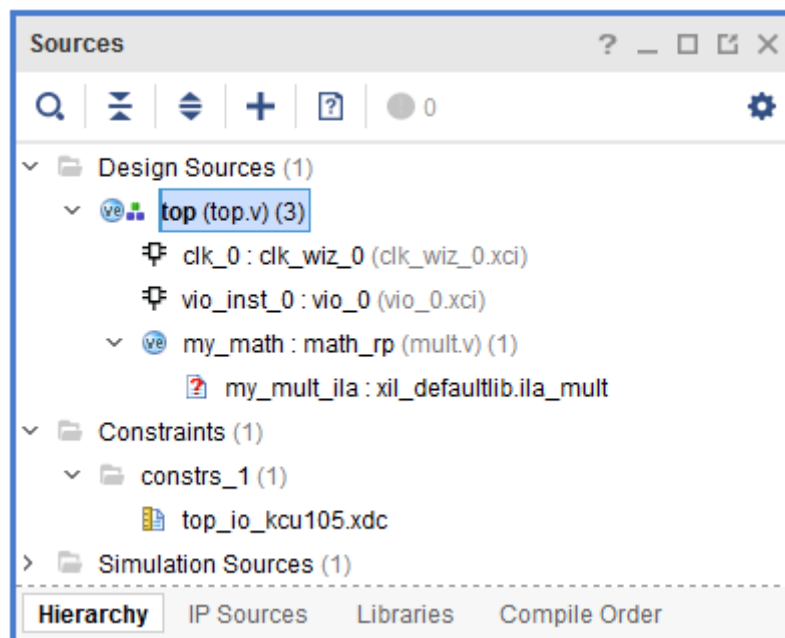

Figure 44: Sources view after project creation

At this point, a standard project is open. Nothing specific to Partial Reconfiguration has been done yet. Next, add an ILA core.

11. Open the IP Catalog and navigate to **Debug & Verification > Debug**.

12. Open the **ILA (Integrated Logic Analyzer)** IP core. Customize an IP with these non-default options:

- Component Name: **ila\_mult**
- Input Pipe Stages: **1**
- Probe Width of PROBE0: **8**

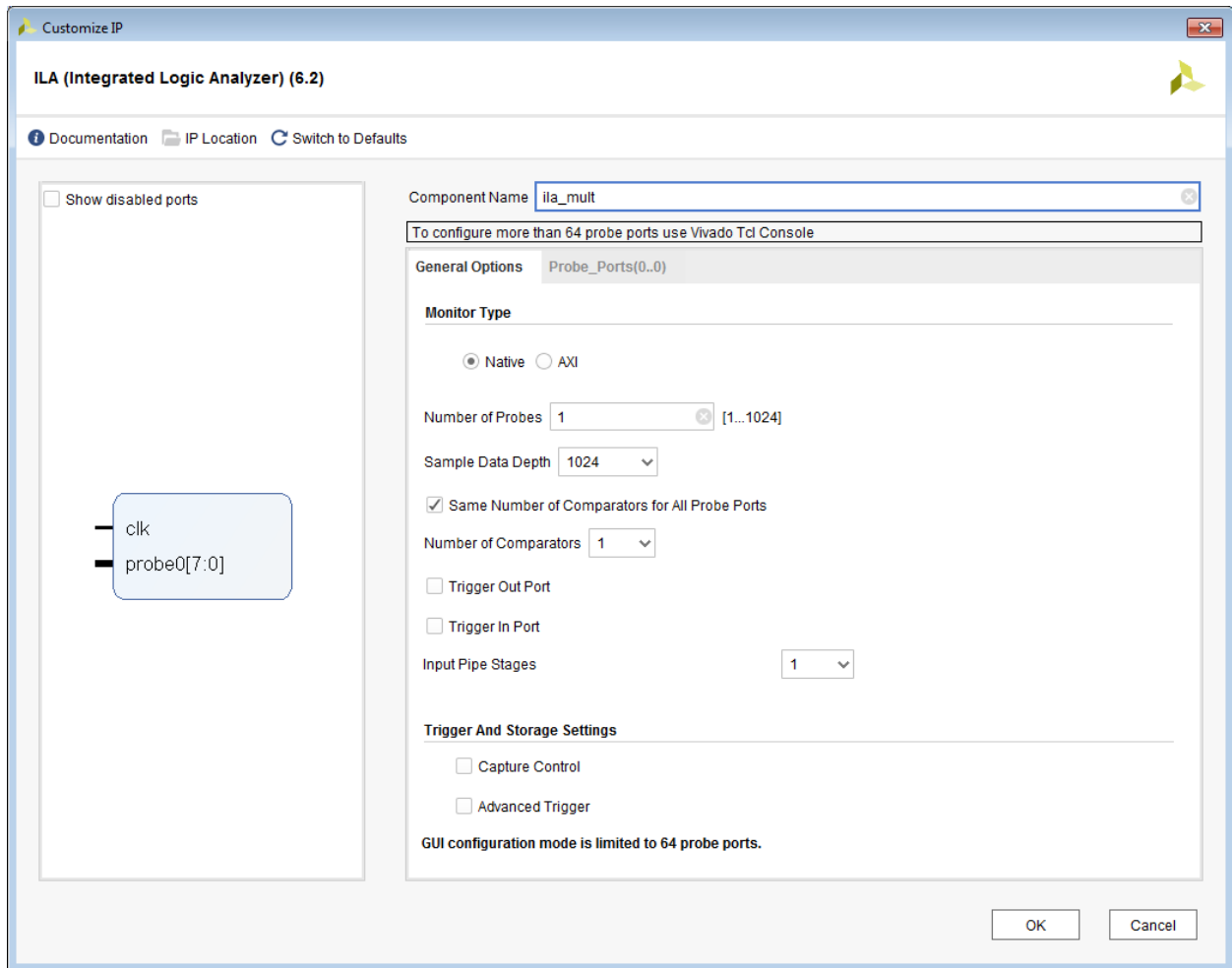

**Figure 45: ILA customized for the Multiplier function**

13. Click **OK** and then **Skip** to create the IP.

Do not select **Generate**. Leave the Synthesis Options set to **Out of context per IP**.

This IP now fills in underneath the **my\_math** hierarchy. This ILA core monitors the multiply function. You have now completed a full design hierarchy.

## Set up the design for Partial Reconfiguration

### 14. Select **Tools > Enable Partial Reconfiguration**

This prepares the project for the PR design flow. Once this is set it cannot be undone, so Xilinx recommends archiving your project before selecting this option.

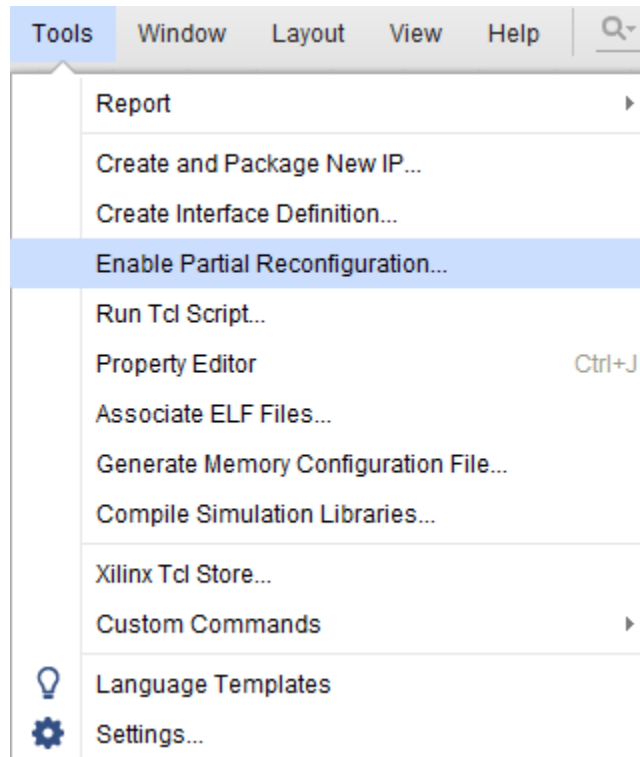

**Figure 46: Enabling Partial Reconfiguration**

In the ensuing dialog box, click **Convert** to turn this project into a PR project.

### 15. Right-click on the **my\_math** instance in the sources window and select the **Create Partition Definition...** option.

This defines this instance as a Reconfigurable Partition in the design. Out-of-context synthesis is run to keep this module separated from top, and the post-synthesis checkpoint is used for both shift instances.



**TIP:** *If there are multiple instantiations of the same module exist within a design, each will be marked reconfigurable. If not all need to be reconfigurable, then the modules must manually modified to become unique. Then you can independently tag desired instances as Reconfigurable Partitions.*

This command will fail in Vivado 2017.1 or 2017.2. In these tool versions, IP are supported within Reconfigurable Modules, but there are a few rules. One is that the IP must not be the top level of the RM. A second is that the IP must not be synthesized out-of-context (OOC). These are restrictions that will be removed in a future release of Vivado.

16. Right-click on the **ila\_mult** IP instance and select **Generate Output Products**.
17. Change the Synthesis Options setting to **Global**, then click **Apply** then **Cancel**. Leave generating the IP for later.

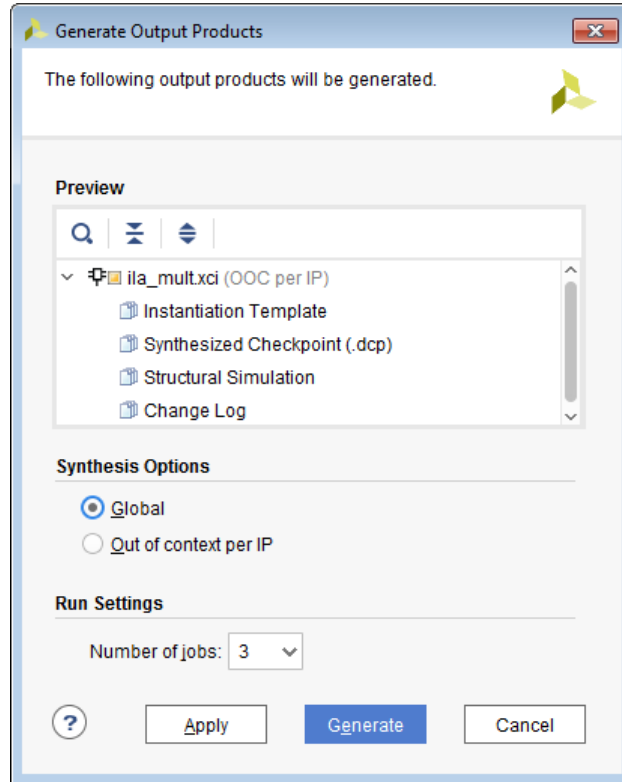
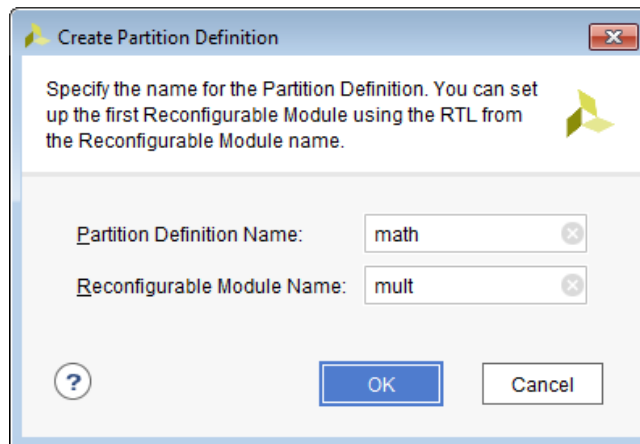

**Figure 47: Set all IP within RMs to Global synthesis**

18. Right-click on the **my\_math** instance in the sources window and select the **Create Partition Definition...** option.
19. In the dialog box that appears, name both the Partition Definition and the Reconfigurable Module.  

The Partition Definition is the general reference for the workspace into which all Reconfigurable Modules will be inserted, so give it an appropriate name: **math**.

The Reconfigurable Module refers to this specific RTL instance, so give it a name that references its functionality: **mult**.
20. Then click **OK**.



**Figure 48: Creating the math Partition Definition**

The Sources view has now changed slightly, with the **my\_math** instance now shown with a yellow diamond, indicating it is a Partition. The **Partition Definitions** tab in this window shows the list and contents of all Partition Definitions (just one in this case) in the design. In addition, an out-of-context module run has been created for synthesizing the **mult** module.

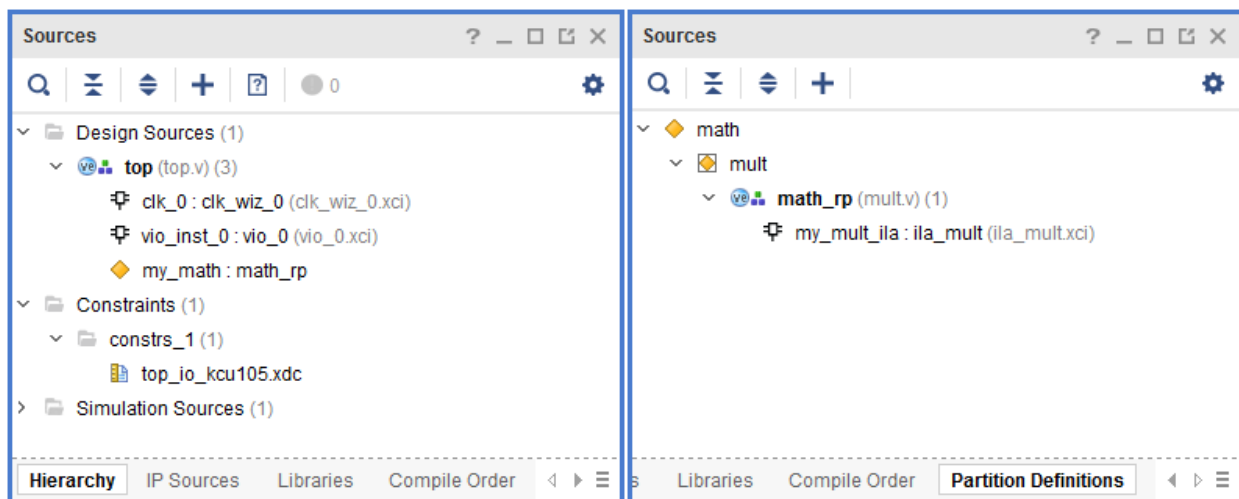

**Figure 49: Sources views after the math partition has been defined**

At this point, new Reconfigurable Modules may be added (or modified) via the Partial Reconfiguration Wizard.



**IMPORTANT:** After Partitions have been defined, all additional RMs must be added via the Partial Reconfiguration Wizard, and any management of RM sources, configurations, and runs must also be done via this wizard.

## Use the Partial Reconfiguration Wizard to complete the rest of the design

21. Launch the **Partial Reconfiguration Wizard** by selecting this option under the Tools menu or from the Flow Navigator.
22. Click **Next** to get to the Edit Reconfigurable Modules page. Here you can see the mult RM already exists, and there are add, remove and edit buttons on the left hand side of the page. Click on the + icon to add a new RM.

23. Click the **Add Files** button to select the top level of the add function:

<Extract\_Dir>\Sources\hdl\add.v

If module-level constraints were needed, they would be added here. Note that they would need to be scoped to the level of hierarchy for this Partition.

24. Click Next.

25. Fill in the Reconfigurable Module field to be **add**. Set the Partition Definition to be **math**, leave Top Module Field empty and the **Sources are already synthesized** option unchecked. Select the **Copy sources into project** checkbox. Click **OK** to create the new module.

Two Reconfigurable Modules are now available for the math Reconfigurable Partition.

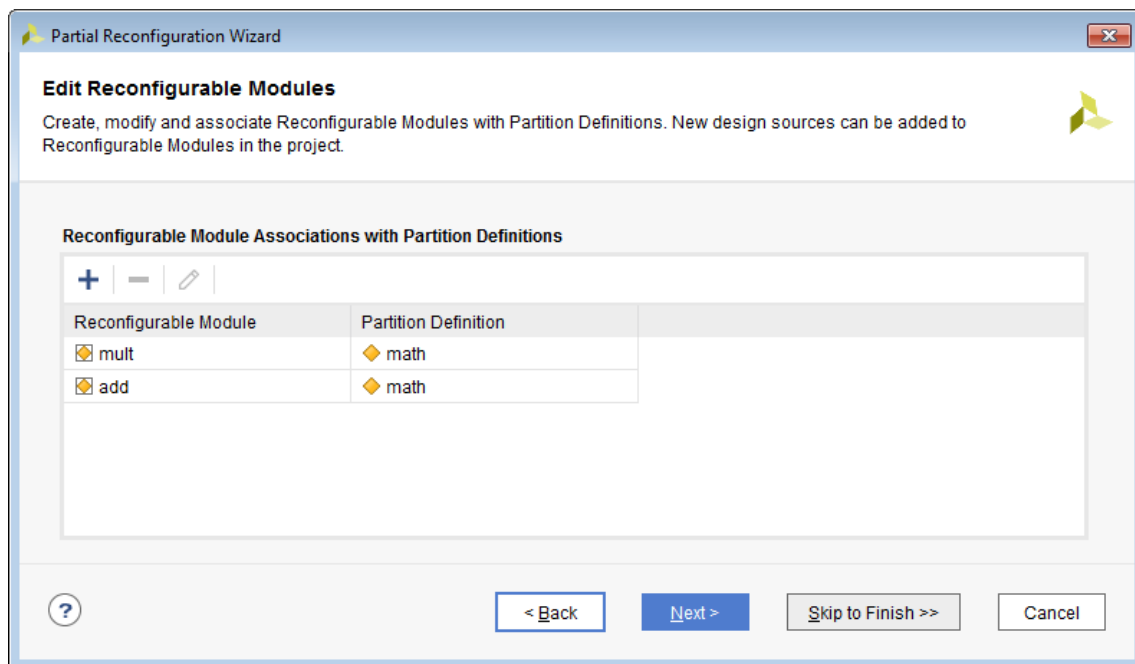

Figure 50: Partial Reconfiguration Wizard with two Reconfigurable Modules defined

On the next page, **Configurations** are defined.

26. Let the Wizard create the configurations by selecting the **automatically create configurations** link.

Configurations are full design images consisting of the static design and one RM per RP. You can either create any desired set of configurations, or simply let the wizard select them for you, as you did above.

The minimum set of two configurations is now created. The math instance has been given **mult** in the first configuration and **add** in the second configuration.

**Note:** The Configuration Name is editable – in Figure 51 the names have been updated to **config\_mult** and **config\_add** to reflect the Reconfigurable Modules contained within each configuration.

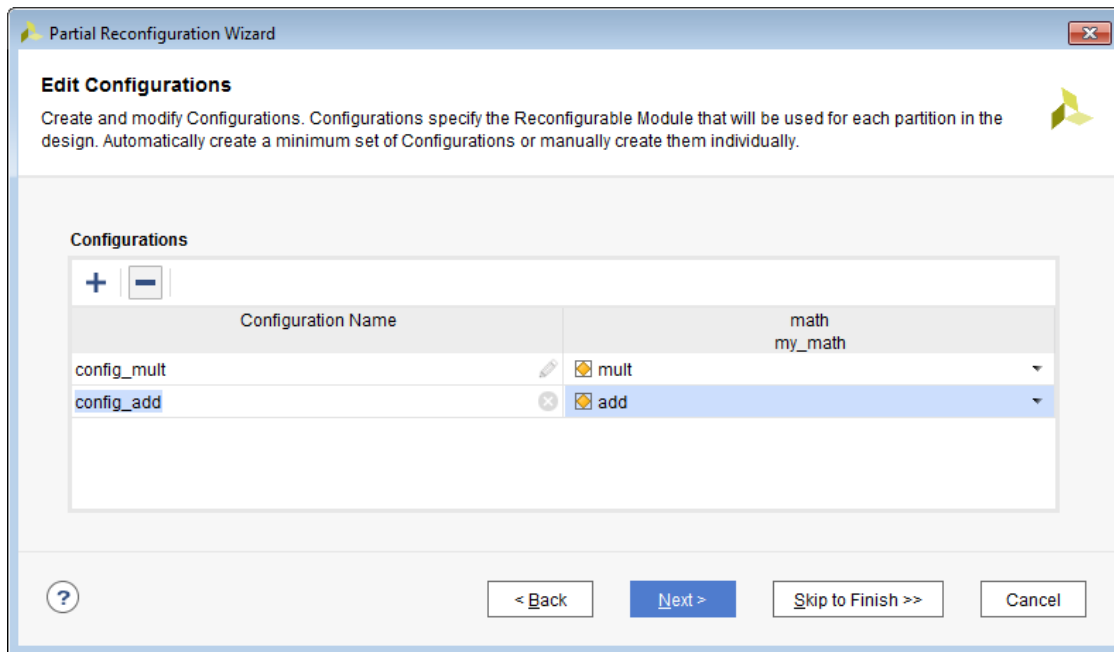

**Figure 51: Auto-Generated minimum set of Configurations with modified names**

Additional configurations can be created by using these two Reconfigurable Modules when desired. Greybox (blackbox with LUT tie-offs) configurations can also be selected, but these are not yet compatible with debug, so this feature will not be used in this lab.

27. Click **Next** to get to the Edit Configuration Runs page.

As with configurations themselves, the runs used to implement each configuration can be automatically or manually created. A parent-child relationship will define how the runs interact – the parent run implements the static design and all RMs within that configuration, then child runs reuse the locked static design while implementing the RMs within that configuration in that established context.

28. Click on the **automatically create configuration run** link to populate the Configuration Runs page with the minimum set of runs.

This creates two runs, consisting of one parent configuration (config\_mult) and one child configuration (config\_add). Any number of independent or related runs can be created



within this wizard with options for using different strategies or constraint sets for any of them. For now, leave this set to the two runs set here. Note that the names of the runs are not editable.

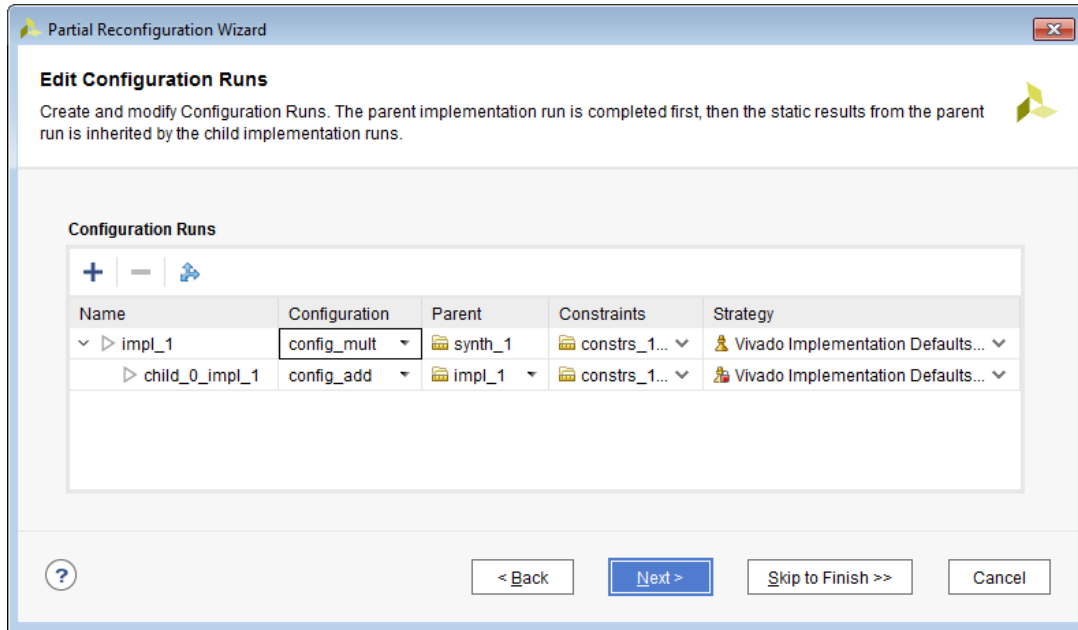

**Figure 52: Auto-generated minimum set of Configuration Runs**

29. Click Next to see the Summary page then Finish to complete the setup and exit the Wizard.



**IMPORTANT:** Nothing is created or modified until you click Finish to exit the Partial Reconfiguration Wizard. All actions are queued until this last click, so it is possible to step forward and back as needed without implementing changes until you are ready.

Back in the Vivado IDE, the Design Runs window has been updated. A second out-of-context synthesis run has been added for the math RM, and a child implementation run (child\_0\_impl\_1) has been created under the parent (impl\_1).

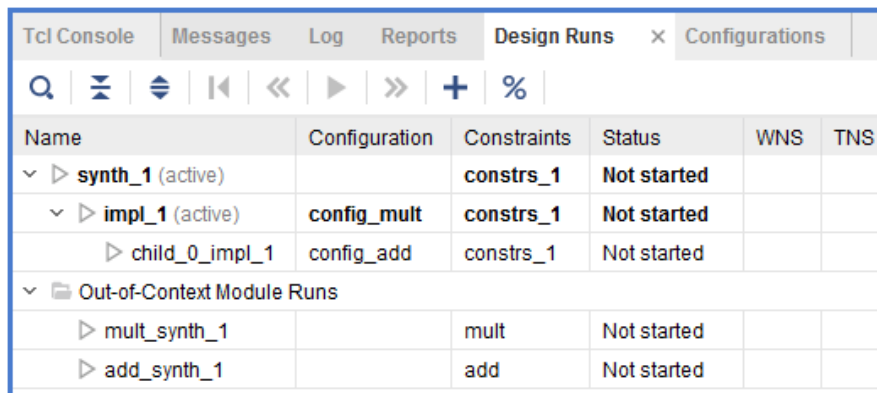

**Figure 53: Design Runs window showing all synthesis and implementation ready to launch**

## Add IP within the Reconfigurable Module

Looking back at the Partition Definitions tab, expand the added RM to see that there are three IP that must be added to complete its functionality.

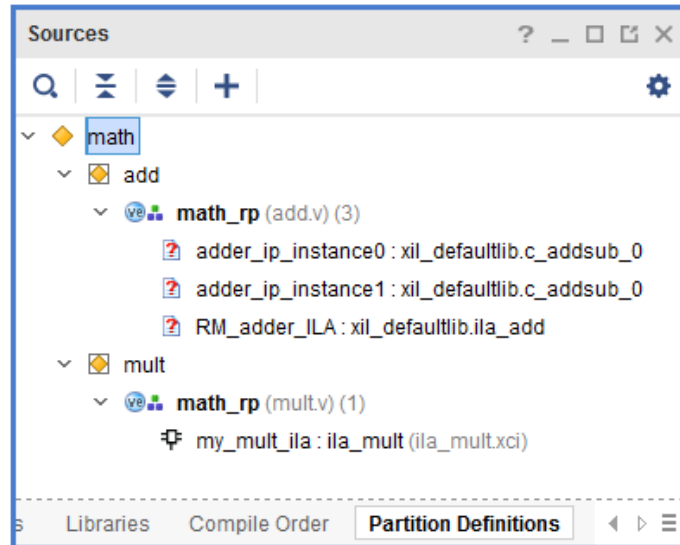

Figure 54: Partition Definitions tab with missing sources for add

All three of these missing modules are IP. Like with the ILA core in the mult RM, they must be added with synthesis set to Global. Moreover, the IP instances must be unique within each RM, so the same ILA core instance cannot be used from static or another RM.

30. Right-click on the **ila\_mult** instance within the mult RM and select **Copy IP**.

31. Set the Destination IP Name to **ila\_add** and leave the Destination IP Location as is, then click **OK**.

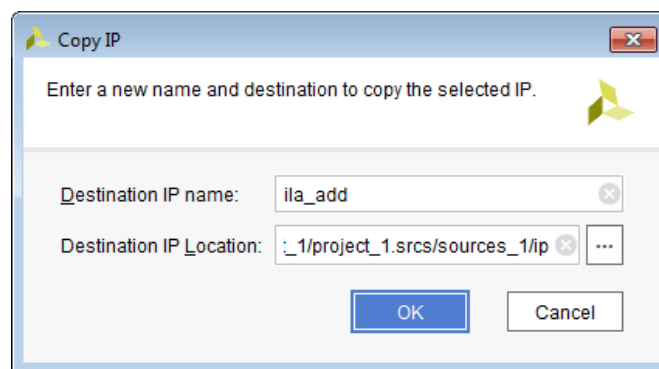
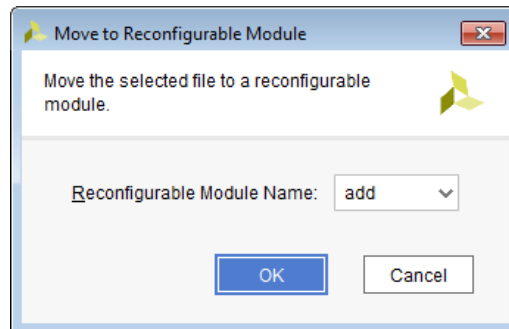

Figure 55: Copying the ILA from math to add

This copied IP will be placed in the main Design Sources hierarchy window in the primary design fileset, so it must be moved to the **add** RM blockset.

32. In the Design Sources window, right-click on the **ila\_add** instance and select **Move to Reconfigurable Module**. Select the **add** RM and click **OK**.



**Figure 56: Moving IP to an RM**

If you navigate back to the partitions definitions tab, you'll see the ILA IP instance was properly moved under the add RM.

33. Open the IP Catalog and search on **add** to find the **Adder/Subtractor** IP. Open this IP and customize it with these non-default options, leaving the name set to `c_addsub_0`:
- Input Type: **Unsigned** (for both A and B)
  - Input Width: **5** (for both A and B)
  - Output Width: **6**
  - Latency: **0**
  - Uncheck the **Clock Enable** on the Control tab
34. Click **OK**.

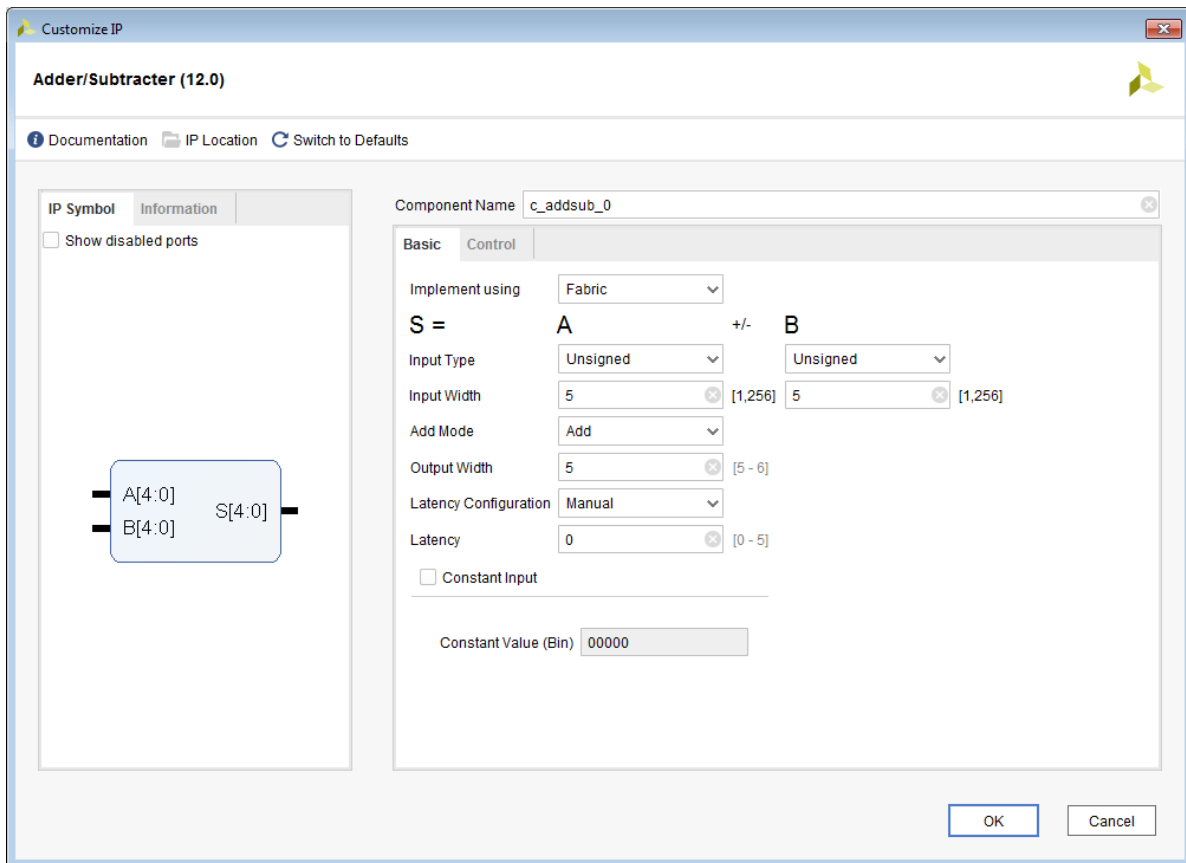

**Figure 57: Customizing the Adder/Subtractor IP**

35. Set the Synthesis Options to **Global**, then click **Apply** and **Skip** to complete IP generation.

Like with the ILA IP, this has been added to the main source set, so follow the same procedure to move it to the add RM.

36. In the Design Sources window, right-click on the **c\_addsub\_0** instance and select **Move to Reconfigurable Module**.

Select the **add** RM and click **OK**.

Note that this IP is used for both adder function instances within the add RM. At this point, the entire design has been loaded, and you are ready to move on to implementation.

## Conclusion

A full design project can be created and managed within the Vivado IDE, with some specific limitations. Reconfigurable Partitions are first defined from within the hierarchical source view in the Vivado IDE, then all manipulation of Reconfigurable Modules, Configurations and Design Runs are done within the Partial Reconfiguration Wizard.

## Section 2 – Managing Design Runs

In this section, you will launch synthesis and implementation runs, compiling the design from RTL to bitstream. You will also create the design floorplan and run PR-specific design rule checks. This section will also cover Vivado debug core creation and management.

### *Synthesize the design and create a floorplan*

Before launching synthesis, take a look at the naming convention that inserts the Debug Hubs necessary for the Vivado Debug solution.

1. Open `mult.v` and examine the port list in this file.

The port list includes twelve ports that start with `S_BSCAN_`. These ports are used to connect the Debug Hubs that are inserted in the static and reconfigurable parts of the design. The insertion of these hubs is automatic. Connections are automatically made as long as the port list matches this naming convention.



**CAUTION!** These **exact** port names must be used to have the inference occur. If the port names differ at all, then the attributes shown in the comments of these RTL files must be used to assign the new signal names to the debug properties as indicated.

With the design from section one open in the Vivado IDE, take a look at the Design Runs window. The top-level design synthesis run (`synth_1`) and the parent implementation run (`impl_1`) are marked “active.” The Flow Navigator actions apply to these active runs, so clicking on Run Synthesis or Run Implementation will pull the design through only these runs, as well as the OOC synthesis runs needed to complete them. You could select the child implementation run, right-click, and select Launch Runs to pull through the entire flow, but we’ll run synthesis separately here.

2. In the Flow Navigator, click **Run Synthesis**. When synthesis completes, select **Open Synthesized Design**.

This action synthesizes all OOC modules, followed by synthesis of the top level design. This is no different than any design with OOC modules (IP or otherwise).

3. Open the schematic for the post-synthesis view to see the insertions performed during synthesis.

In the top level design, see that a **dbg\_hub** instance was inserted. Its `sl_*` ports are connected to the VIO debug core at the top level. Next, descend into the **my\_math** hierarchy to see that another **dbg\_hub** instance has been inserted, with its `sl_*` ports connected to the ILA debug core in that module. Note that this Reconfigurable Module is the multiplier, as this is the schematic view of the active parent run.

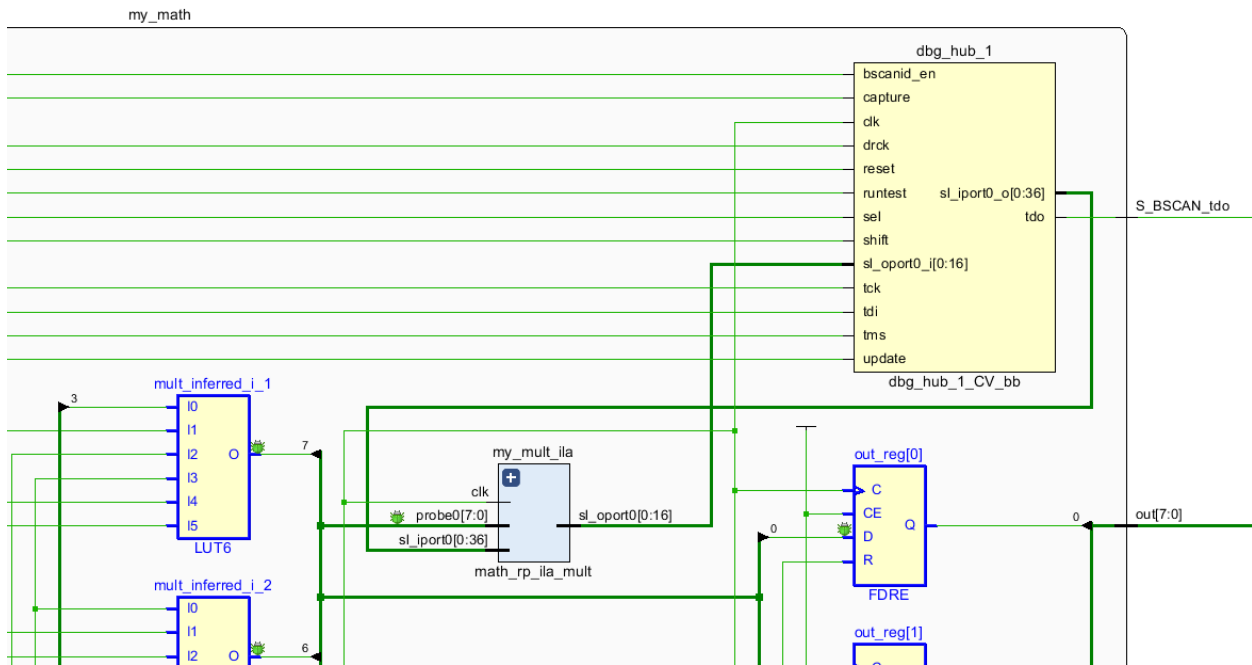

**Figure 58: dbg\_hub\_1 inserted within the mult RM**

4. Select **Layout > Floorplanning** to put Vivado in floorplanning mode. Then in the Netlist window, right click on the **my\_math** instance and select **Floorplanning > Draw Pblock**. Create a Pblock wherever you'd like. In the dialog box that appears, keep the name **pblock\_my\_math** and leave only CLB, DSP and BRAM resource types checked.

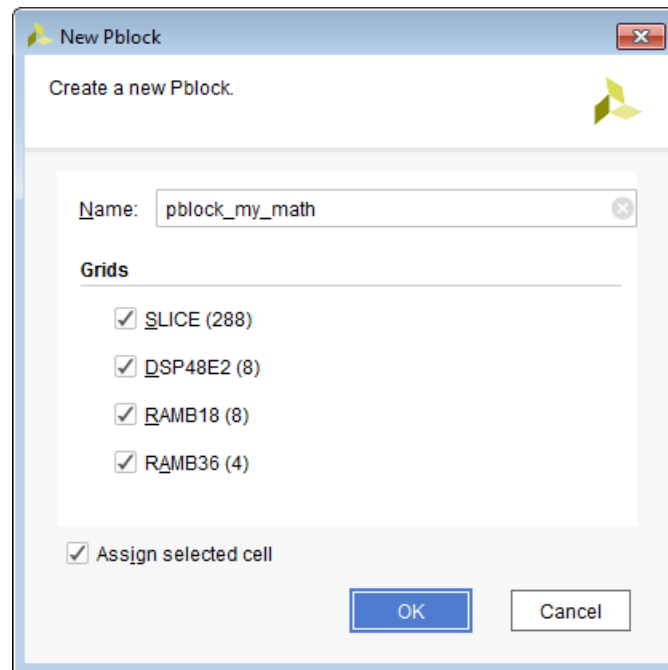

**Figure 59: Drawing a Pblock for the my\_math RP**

If the region you have selected does not have enough resources of any particular type, these resource types will appear in red in the Statistics tab of the Pblock Properties window. Make adjustments as necessary, then save the floorplan. Remember, each RM contains an ILA core, which will require BRAM. Also, this design has a high number of control sets, so the region required may be a little bigger than expected. An area of at least 3000 CLBs plus a column of BRAM is suggested.

5. Run PR-specific design rule checks by selecting **Tools > Report > Report DRC**. To save time, you can deselect all checkboxes other than the one for Partial Reconfiguration.

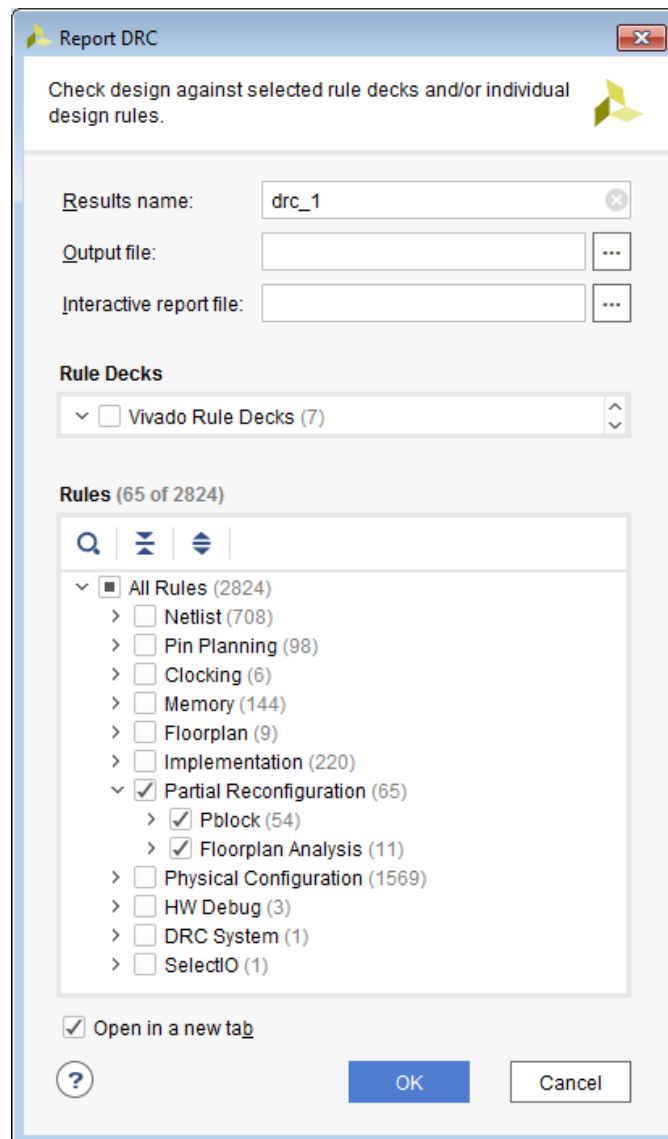

**Figure 60: Checking Partial Reconfiguration DRCs**

Fix any errors that may appear. Advisory messages might appear for certain devices with suggestions on how to improve the quality of the given Pblocks.



**TIP:** Run Partial Reconfiguration Design Rule Checks early and often.

6. Save your constraints by clicking **Save** in the top toolbar.

### **Run the PR Configuration Analysis report**

The PR Configuration Analysis tool compares each Reconfigurable Module that you select to give you input on your PR design. It examines resource usage, floorplanning, clocking, and timing metrics to help you manage the overall PR design. The PR Configuration Analysis tool is run through the Tcl Console.

7. In the Tcl Console, `cd` into the project directory. Next, enter this command to run a report on the two RMs available in this design:

```
report_pr_configuration_analysis -cells my_math -dcps  
{./project_1.runs/add_synth_1/math_rp.dcp  
./project_1.runs/mult_synth_1/math_rp.dcp}
```

**Note:** If your project is not named "project\_1" you'll need to adjust this in the Tcl command.

This runs the analysis with the default settings, gathering data for the first three focus areas listed below. Use the `-help` option to see that you can focus on three specific areas.

- The `-complexity` switch focuses the report on resource usage, including the maximum resources required for the RP.
- The `-clocking` switch focuses the report on clock usage and loads for each RM.
- The `-timing` switch focuses the report on boundary interface timing details.
- The `-rent` switch adds rent metrics to the report, but can take a long time to run.
- The `-file` switch redirects the report to a file.

### **Implement the design**

8. In the Flow Navigator, select **Run Implementation** to run place and route on all configurations.

This action runs implementation first for `impl_1` and then for `child_0_impl_1`. In addition to running place and route for the two runs with all the PR requirements in place, it does a few more tasks specific to PR. After `impl_1` completes, Vivado automatically:

- Writes a module-level (OOC) checkpoint for the routed multiplier RM.
- Carves out the logic in the RP to create a static-only design image. This is done by calling `update_design -black_box` for the RP instance.
- Locks all placement and routing for this static-only design. This is done by calling `lock_design -level routing`.



- Saves this locked static parent image to be reused for all child runs.

In addition, when the child run completes, a module-level checkpoint is created for the routed adder RM. A locked static design image would be identical to the parent, so this step is not necessary.

In Vivado projects, dependency management is handled by the Vivado IDE. If sources are modified, any applicable runs will be marked out-of-date. The parent-child relationship means these checks must understand dependencies. For example, if **add.v** is modified, only its OOC synthesis run and the child implementation run would be marked out of date.

If only specific configuration runs are desired, these can be individually selected within the Design Runs window. Note that a parent run must be completed successfully before a child run can be launched, as the child run starts by importing the locked static design from the parent.

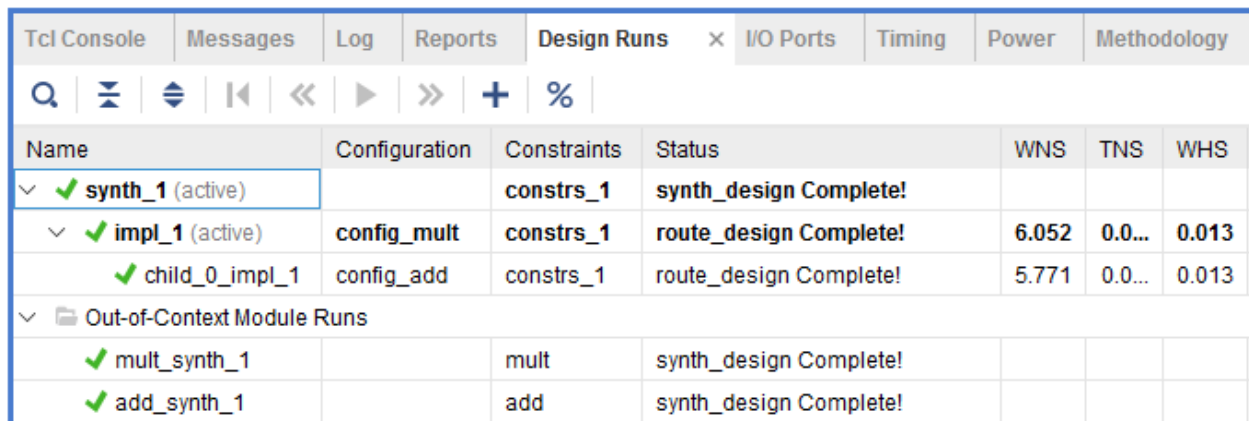

Name	Configuration	Constraints	Status	WNS	TNS	WHS
✓ synth_1 (active)		constrs_1	synth_design Complete!			
✓ impl_1 (active)	config_mult	constrs_1	route_design Complete!	6.052	0.0...	0.013
✓ child_0_impl_1	config_add	constrs_1	route_design Complete!	5.771	0.0...	0.013
Out-of-Context Module Runs						
✓ mult_synth_1		mult	synth_design Complete!			
✓ add_synth_1		add	synth_design Complete!			

Figure 61: Both Configurations routed

9. When Implementation of the parent run completes, click **Open Implemented Design** in the resulting pop-up dialog. The next few steps can be done while the child run is running. When this dialog comes up the second time, click **Cancel**, otherwise it will reload the parent configuration.



**CAUTION!** Even though the design has been processed through to the child implementation run, selecting **Open Implemented Design** always opens the parent run, as that design is one defined as active. Currently, multiple pop-ups appear, one for each implementation run, but they all open the parent run.

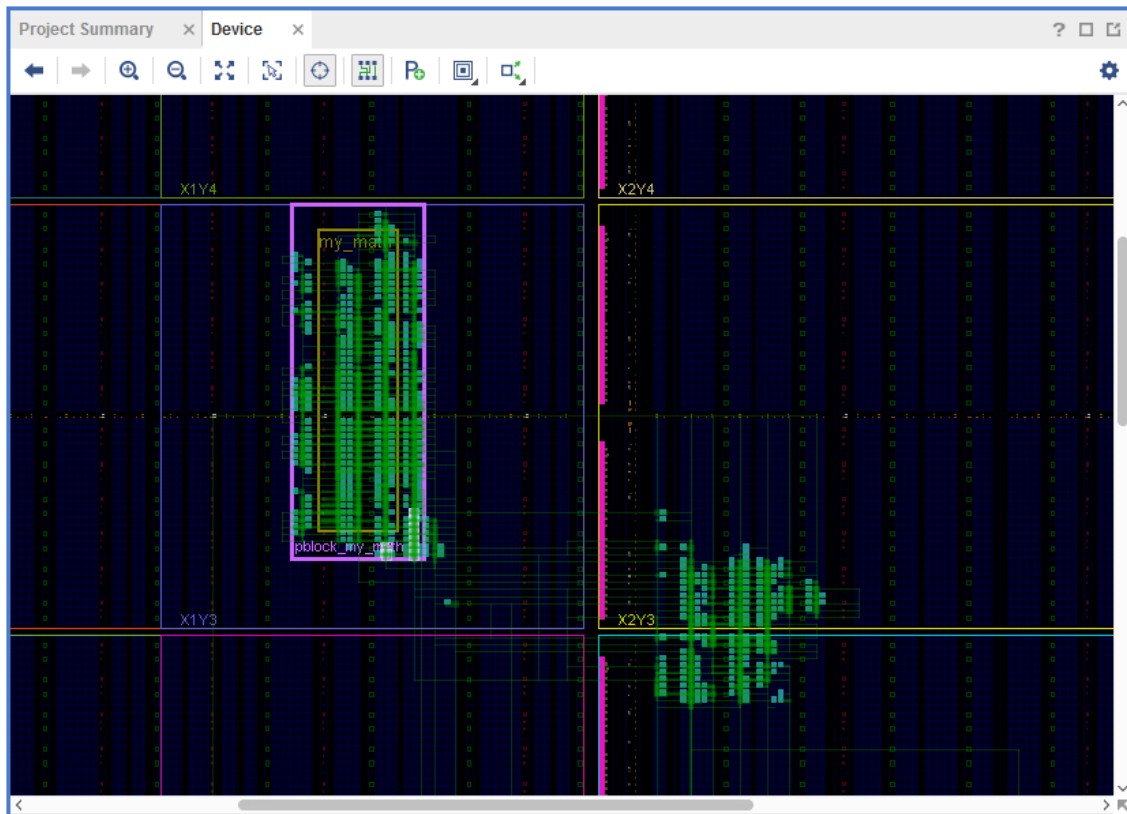

**Figure 62: Device view of the routed parent design**

This is the routed design for the multiplier configuration. Next, take a look at the frameset of the placement and routing areas.

10. In the Tcl Console, `cd` to the current project directory (if you are not already there). Then run these commands to source visualization scripts:

```
source project_1.runs/impl_1/hd_visual/pblock_my_math_Routing_AllTiles.tcl
highlight_objects -color yellow [get_selected_objects]
```

This first Tcl script identifies the frames that are valid for routing the reconfigurable part of the design. Note that it extends to the height of the clock region(s) occupied by the Pblock, and extends left and right by two programmable units. (Programmable units are pairs of resource columns.)

11. Run these commands to identify the frameset used for placing the reconfigurable part of the design.

```
source project_1.runs/impl_1/hd_visual/pblock_my_math_Placement_AllTiles.tcl
highlight_objects -color blue [get_selected_objects]
```

This highlighted region will be either the Pblock area itself, or an area just smaller than the Pblock if the Pblock did not align with programmable units boundaries.

Your device view should look something like this:

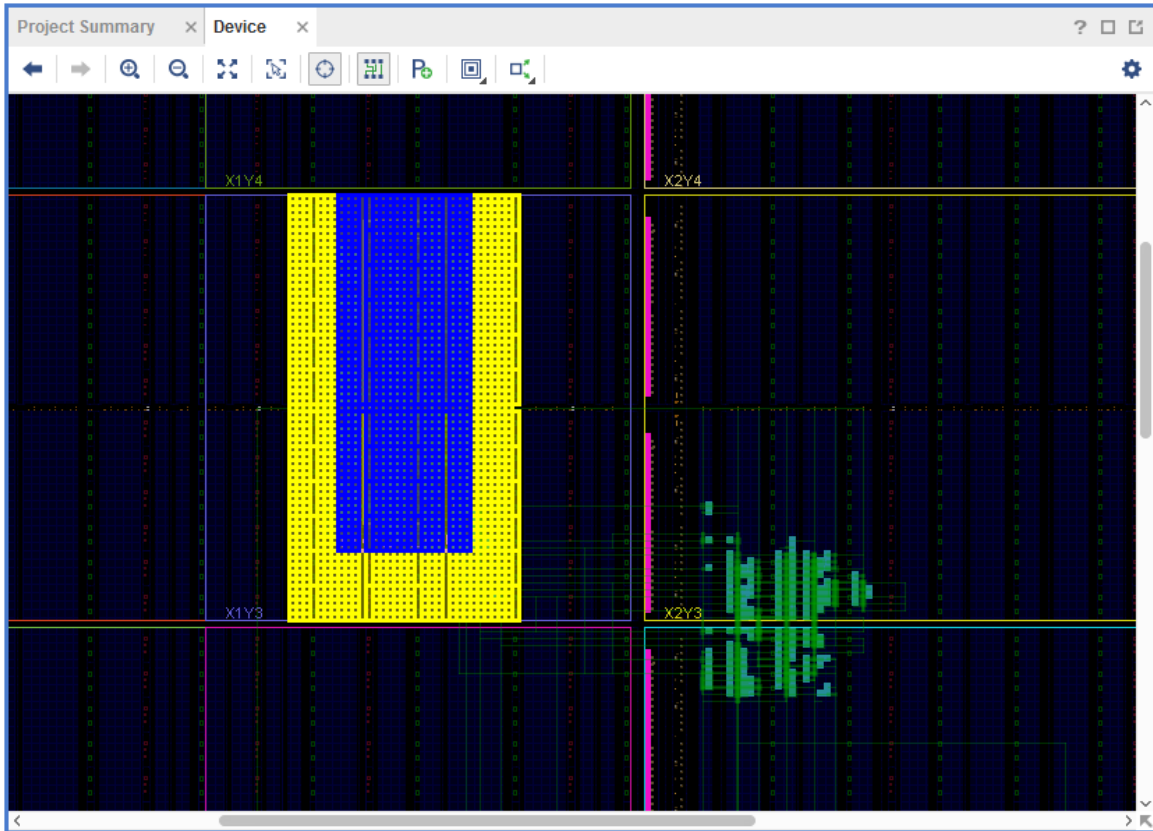

**Figure 63: The math RP highlighted to show placement (blue) and routing (yellow) boundaries**

Static logic may be placed in the expanded routing region, which is now the remaining yellow region. Static routing can use any resources in the device.

12. In the Timing tab, select the **Design Timing Summary** and click on the value for the Worst Negative Slack (WNS) to bring up the top ten worst paths. Double-click on the first path to open the timing summary on that path.

In this timing report, note that in the Clock Paths and the Data Path, there is a new column labeled Partition that shows which partition (or boundary) that particular part of the path is in.



**CAUTION!** You will likely need to expand this timing report window or adjust the column widths to see the Partition column. It is the last column on the right.

Delay Type	Incr (ns)	Path (...)	Location	PBlock	Netlist Resource(s)	Partition
(clock clk_out1_clk_wiz_0 rise edge)	(r) 9.999	9.999				
net (fo=0)	0.000	9.999	Site: AK17		clk_in1_p	static
DIFFINBUF (Prop DIFFINBUF_HPIOBDIFFINBUF_DIFF_IN_P_O)	(r) 0.318	10.317	Site: HPIOBDIFFINBUF_X0Y35		clk_0/inst/clk_in1_jbufds/I	static
net (fo=1, routed)	0.051	10.368			clk_0/inst/clk_in1_jbufds/OUT	static
IBUFCTRL (Prop IBUFCTRL_HPIOB_I_O)	(r) 0.000	10.368	Site: AK17		clk_0/inst/clk_in1_jbufds/IBUFCTRL_INST/O	static
net (fo=1, routed)	0.778	11.146			clk_0/inst/clk_in1_clk_wiz_0	static
MMCME3_ADV (Prop MMCME3_ADV_CLKIN1_CLKOUT0)	(r) -4.949	6.197	Site: MMCME3_ADV_X0Y1		clk_0/inst/mmcme3_adv_inst/CLKOUT0	static
net (fo=1, routed)	0.345	6.542			clk_0/inst/clk_out1_clk_wiz_0	static
BUFCE (Prop BUFCE_BUFCE_I_O)	(r) 0.075	6.617	Site: BUFCE_X0Y38		clk_0/inst/clkout1_buf/O	static
net (fo=1940, routed)	2.173	8.790	Clock region: ... (CLOCK_ROOT)		my_math/my_mult_ila/i...TL_EQ1.U_CTL/s_dc...	boundary
FDRE			Site: SLICE_X35Y214	pblock_my_math	my_math/my_mult_ila/in...CTL/xsdb_reg[1...	reconfigurable
clock pessimism	0.200	8.990				
clock uncertainty	-0.074	8.916				
FDRE (Setup_HFF_SLICEM_C_CE)	-0.047	8.869	Site: SLICE_X35Y214	pblock_my_math	my_math/my_mult_ila/i...CTL/xsdb_reg[1...	reconfigurable
<b>Required Time</b>		8.869				

Figure 64: Timing report path with partitions shown

13. Close the impl\_1 implemented design.

## Add an additional Reconfigurable Module and corresponding Configuration

In this section, you add a third RM and implement its configuration. This new RM is the same multiplier function but with the ILA instantiation commented out. Even though there are no debug cores in this module, the Debug-specific port names (and corresponding attributes if used) are still required for consistency across all RMs. These ports are tied off via LUTs much like the greybox flow.



**CAUTION!** Actual greybox configurations (blackbox RMs with LUT tie-offs) are not yet supported with the Debug Hub insertion flow. This will be supported in a future Vivado release.

14. Open the Partial Reconfiguration Wizard.

15. On the **Edit Reconfigurable Modules** page, click the + button to add a new RM.

16. Select the `mult_no_ila.v` file in `<Extract_Dir>\Sources\hdl`, name the Reconfigurable Module **mult\_no\_ila**, then click **OK** and **Next**.

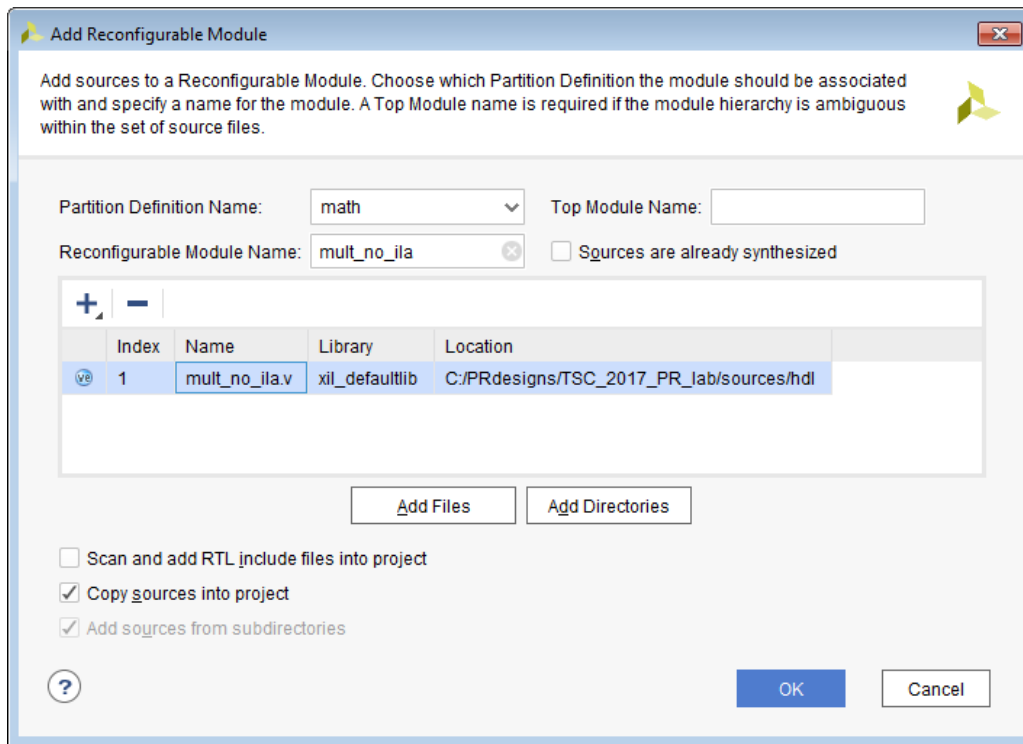

**Figure 65: Adding a new RM mult\_no\_ila**

Note that on the Edit Configurations page, there is no longer an option to automatically create configurations, as you already have two existing ones. You can re-enable this option by removing all existing configurations, but this recreates all configurations and removes all existing results.

17. Create a new configuration by clicking the + button, entering the name **config\_mult\_no\_ila**, then clicking **OK**. Select **mult\_no\_ila** for the Reconfigurable Partition instance.

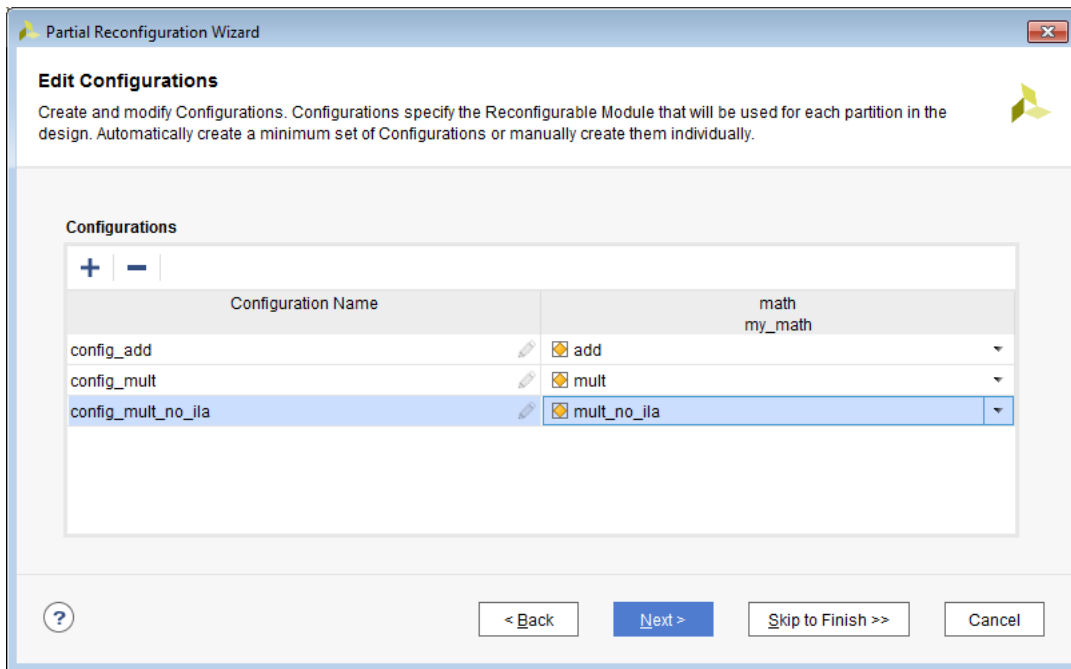

**Figure 66: Creating the mult\_no\_ila configuration**

18. Click **Next** to advance to the Configuration Runs. Use the + button to create a new configuration with these properties:
- Run: **child\_1\_impl\_1** – this matches the existing convention, although it can be named anything.
  - Parent: **impl\_1** – this makes this configuration a child run of the existing parent run
  - Configuration: **config\_mult\_no\_ila** – this is the one with the new RM

Click **OK** to accept this new configuration.



**Figure 67: Creating a new Configuration Run**

This new configuration, as a child of the existing impl\_1, will reuse the static design implementation results, just like config\_add did. Three runs now exist, with two as children of the initial parent. The green check marks indicate that two of the runs are currently complete.

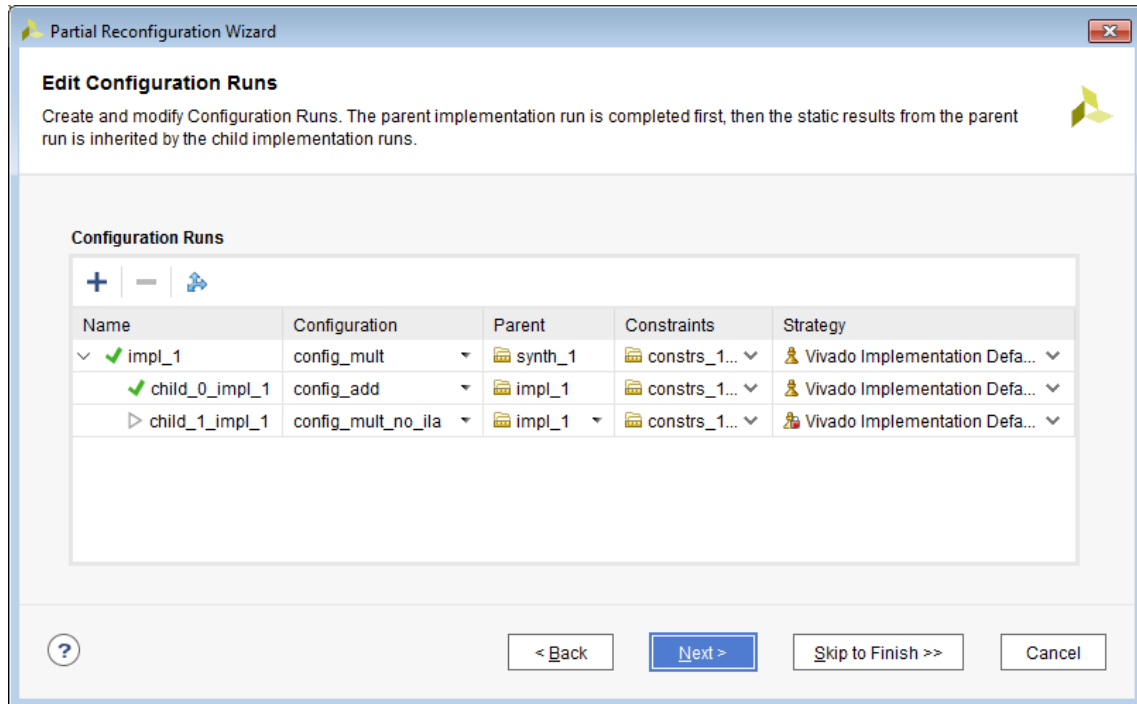

Figure 68: The config\_mult\_no\_ila configuration added as a new child run

19. Click **Next** then **Finish** to build this new configuration run.

Tcl Console   Messages   Log   Reports   Design Runs   Configurations						
Name	Configuration	Constraints	Status	WNS	TNS	
✓ synth_1 (active)		constrs_1	synth_design Complete!			
✓ impl_1 (active)	config_mult	constrs_1	route_design Complete!	6.052	0.000	
✓ child_0_impl_1	config_add	constrs_1	route_design Complete!	5.606	0.000	
▶ child_1_impl_1	config_mult_no_ila	constrs_1	Not started			
Out-of-Context Module Runs						
✓ mult_synth_1		mult	synth_design Complete!			
✓ add_synth_1		add	synth_design Complete!			
▶ mult_no_ila_synth_1		mult_no_ila	Not started			

Figure 69: New OOC synthesis run and Configuration run added

20. Select this new child implementation run, right-click and select **Launch Runs**. This runs OOC synthesis on the `mult_no_ila` module, then implements this module within the context of the locked static design.



---

**CAUTION!** Do not select *Run Implementation* from the Flow Navigator. It will rerun all the implementation runs, even those that have completed.

---

21. Click **Cancel** on the dialog that opens after implementation completes.  
Right-click on `child_1_impl_1` and select **Open Run**. In the device view note two things:
  - a. The static logic is locked and therefore appears orange.
  - b. The amount of logic in the RP Pblock is much smaller than for the other configurations.
22. Select **Tools > Schematic** (or hit F4) to open the schematic view. Descend into the `math_rp` instance to see that all the BSCAN ports are tied to LUTs and no ILA or `Dbg_Hub` cores are inserted.

## Generate bitstreams

At this point, there are two steps remaining. The first is running PR Verify to compare the two configurations to ensure consistency of the static part of the design images. This step is highly recommended and will occur automatically within the Vivado project. The second step is to generate the bitstreams themselves.

23. In the Flow Navigator, click **Generate Bitstream**. This action launches bitstream generation on the active parent run, and launches PR Verify and then bitstream generation on the implemented child runs.

Note that by default a full design bitstream is generated for the parent configuration only. This may not be the desired configuration for power-on configuration. If a full device bitstream is desired for a child run, a property can be set to enable this capability:

```
set_property GEN_FULL_BITSTREAM 1 [get_runs <child_run_name>]
```

Currently, `write_bitstream` has two options that can be manually called to control these details: the `-cell` option requests that only a specific partial bitstream is created, and the `-no_partial_bitfile` option requests only the full design configuration image.

24. When bitstream generation completes, select **Open Hardware Manager**.

## Conclusion

The entire Partial Reconfiguration flow can be run in a project environment. All steps, from module-level synthesis to bitstream generation can be done without leaving the GUI.



## Section 3 – Debugging the Partial Reconfiguration design

### *Connect to the board and program the FPGA*

1. Open the hardware manager and connect to a target KCU105 board.  
This can be a local KCU105 or one on a remote server. Exact details of how to accomplish this task will depend on your setup and are excluded from this document. You can interact with this design remotely via the VIO and ILA debug cores.
2. Once you are connected to the hardware, right-click on the KU040 instance and select **Program Device**. The `top.bit` file should be selected by default from the `project.runs/impl_1` directory. If it is not, select `top.bit` from the `impl_1` project run directory. Note that the `top.ltx` probes file is automatically selected. This is a complete device bitstream that includes the multiplier RM.
3. Click on the **hw\_vios** dashboard tab.
4. Press the **+** button and select all the probes from the add probes dialog box, then click **OK**.

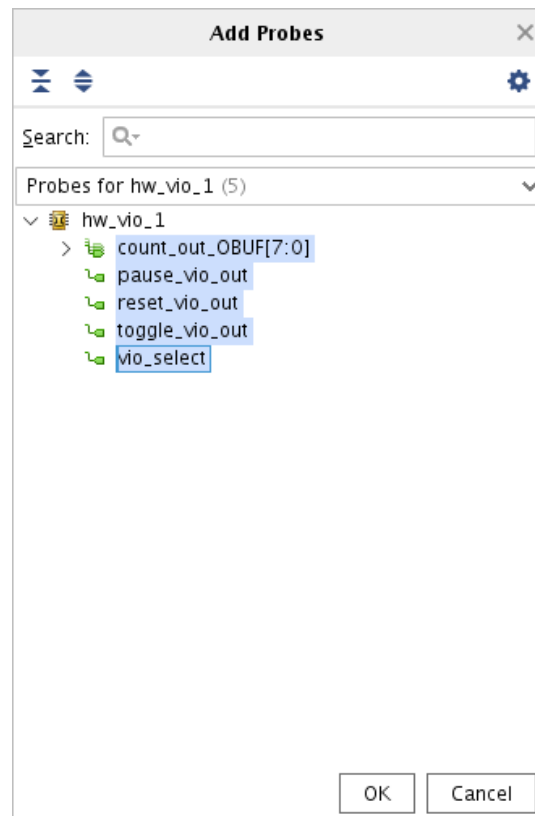
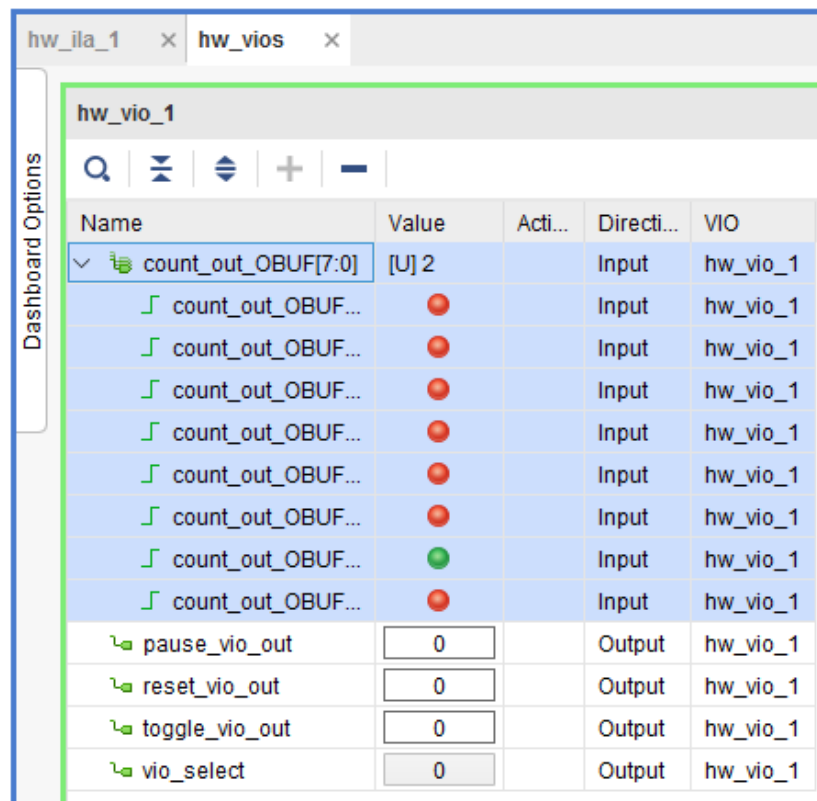

Figure 70: Selecting probes for debug

5. Right click on the probes and set them up in the following manner:

- count\_out\_OBUF[7:0] bus – Radix: unsigned decimal
- count\_out\_OBUF[7:0] individual bits – LED: low value Red, high value Green
- pause\_vio\_out – Active High Button
- reset\_vio\_out – Active High Button
- toggle\_vio\_out – Active High Button
- vio\_select – Toggle Button

The resulting dashboard will look like this:



**Figure 71: Initial VIO dashboard for debugging**

6. Change the vio\_select value to a **1**. This disables the buttons on the physical board and enables the pause, reset and toggle buttons via the VIO.
7. Select the **pause** button, you will see the LED counter stop at a particular value. Take note of the unsigned binary value of the count\_out\_OBUF. In this screenshot, the value is 12.

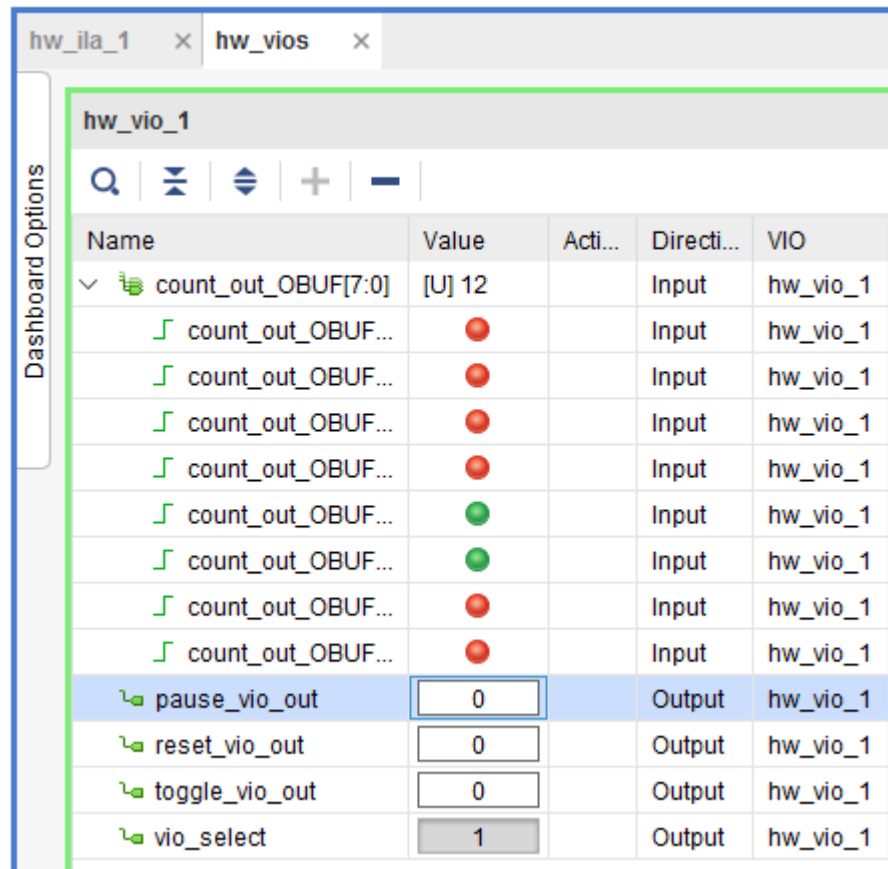

Name	Value	Acti...	Directi...	VIO
count_out_OBUF[7:0]	[U] 12		Input	hw_vio_1
count_out_OBUF...	●		Input	hw_vio_1
count_out_OBUF...	●		Input	hw_vio_1
count_out_OBUF...	●		Input	hw_vio_1
count_out_OBUF...	●		Input	hw_vio_1
count_out_OBUF...	●		Input	hw_vio_1
count_out_OBUF...	●		Input	hw_vio_1
count_out_OBUF...	●		Input	hw_vio_1
count_out_OBUF...	●		Input	hw_vio_1
pause_vio_out	<input type="text" value="0"/>		Output	hw_vio_1
reset_vio_out	<input type="text" value="0"/>		Output	hw_vio_1
toggle_vio_out	<input type="text" value="0"/>		Output	hw_vio_1
vio_select	<input type="text" value="1"/>		Output	hw_vio_1

**Figure 72: Monitoring the counter via VIO**

- Press the **toggle\_vio\_out** button. The value of the count\_out\_OBUF bus be squared, as the current RM is a multiplier. In this case, 144.
- Press the **pause** button again and the counter will start. The count\_out\_OBUF values will now count by the square of 0 to 15. Ex. 1, 4, 9, 16, 25, etc.
- Press the reset button to return the design to its default state. This count resumes to its initial 0 to 15 range.
- Play with these buttons to understand the design. If you have a local board, you can toggle the vio\_select and use the buttons on the board and the LEDs on the board to observe the same behavior.
- Switch to the ILA dashboard. Up to this point you have used the VIO located in the static design. You can see the result of the multiplier, but if you want to observe the waveforms inside the RM, you can do this with the ILA located there.
- In the trigger setup window, press the + button and add the **my\_math/mult[7:0]** probes. Change the radix to unsigned decimal and set the value to 196 (i.e. 14x14)

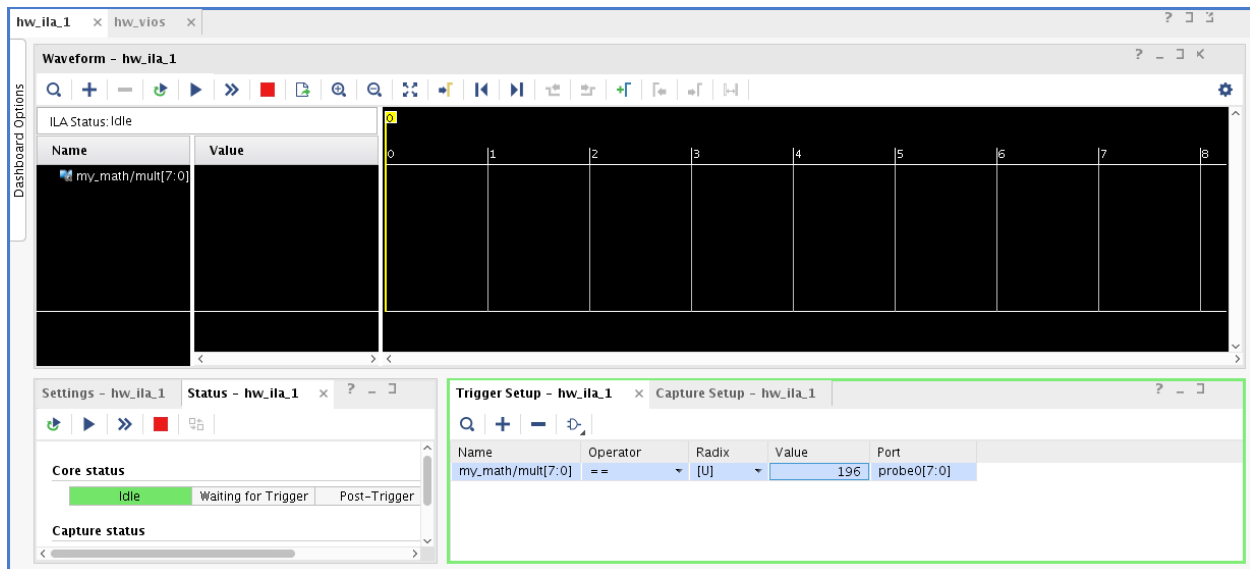

Figure 73: Defining probes within the mult RM

14. In the settings window for the ILA, change the trigger position in the window to 512.

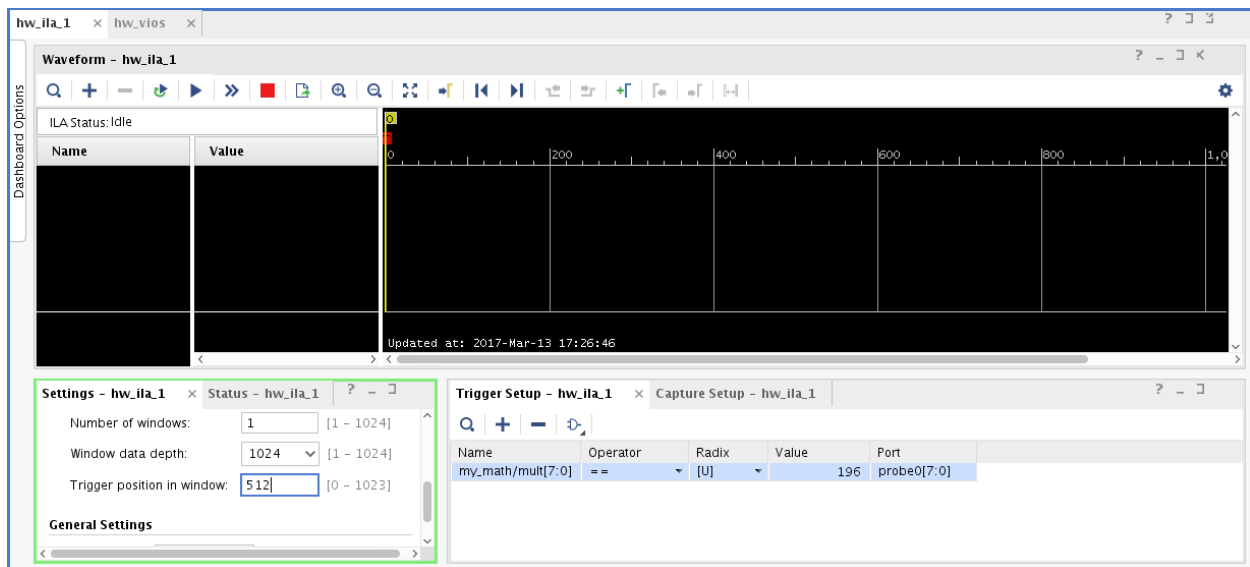
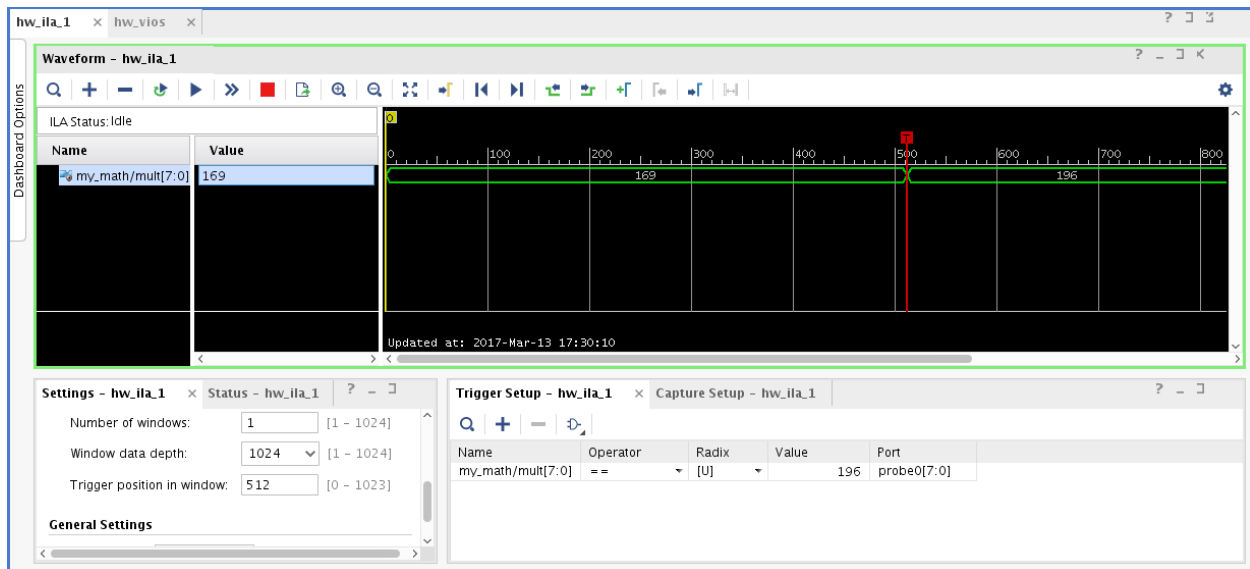

Figure 74: Setting the trigger position

15. Click on the **run trigger** button in the waveform toolbar. You will see the transition of the waveform from 169 to 196 (i.e.  $13^2$  to  $14^2$ ).

**Note:** Make sure the VIO does not have the design paused, or the trigger will not occur.



**Figure 75: Watching the multiply function**

16. Now load the partial bitstream for the adder. Right click on the **xcku040\_0** part in the hardware view and choose **Program Device**.
17. Since this example is using an UltraScale part, you must first program the clearing bitstream to prepare the design for the next partial bitstream. For the bitstream file choose the multiplier clearing bitstream. Navigate to the `project.runs/impl1/` directory and choose the **my\_math\_mult\_partial\_clear.bit** file.

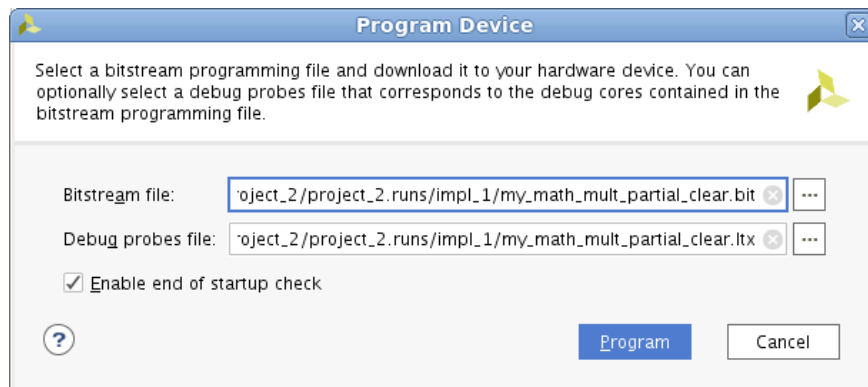
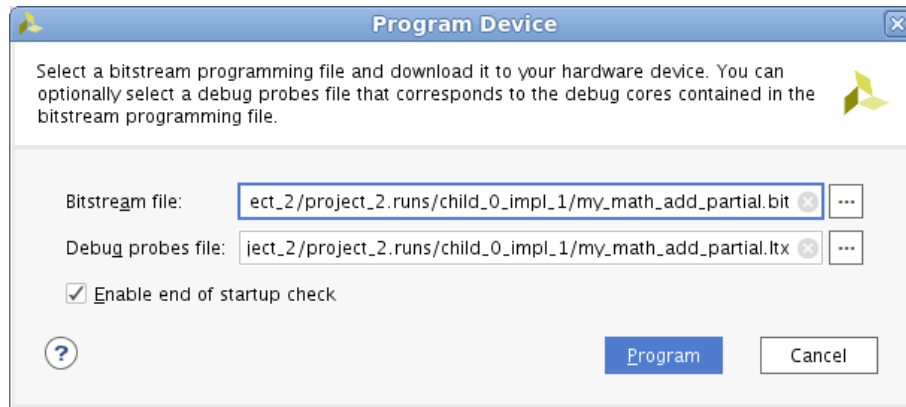

**Figure 76: Selecting the clearing bitstream that corresponds to the current RM**

The paired LTX file will be picked up automatically. Click **Program**.

18. Switch to the VIO dashboard, and observe that the counter is still counting. If you press the toggle button to switch to the multiplier output, the value is held at 255. This is because the logic in the Reconfigurable Partition is currently disabled. Click the toggle button to switch back to the counter. Remember, `vio_select` must be set to a 1 to control remotely.
19. Right click on the **xcku040\_0** part in the hardware view and choose **Program Device**...

20. For the Bitstream file, navigate to the project.runs/child\_0\_impl\_1/ directory and choose the **my\_math\_add\_partial.bit** file.



**Figure 77: Selecting the new partial bitstream**

Once again, the matching LTX file will populate automatically. Click **Program**.

21. On the VIO dashboard. Select **pause**. In this case, the value stopped at 6. After a toggle, the value is 18. The adder adds the same number 3 times.

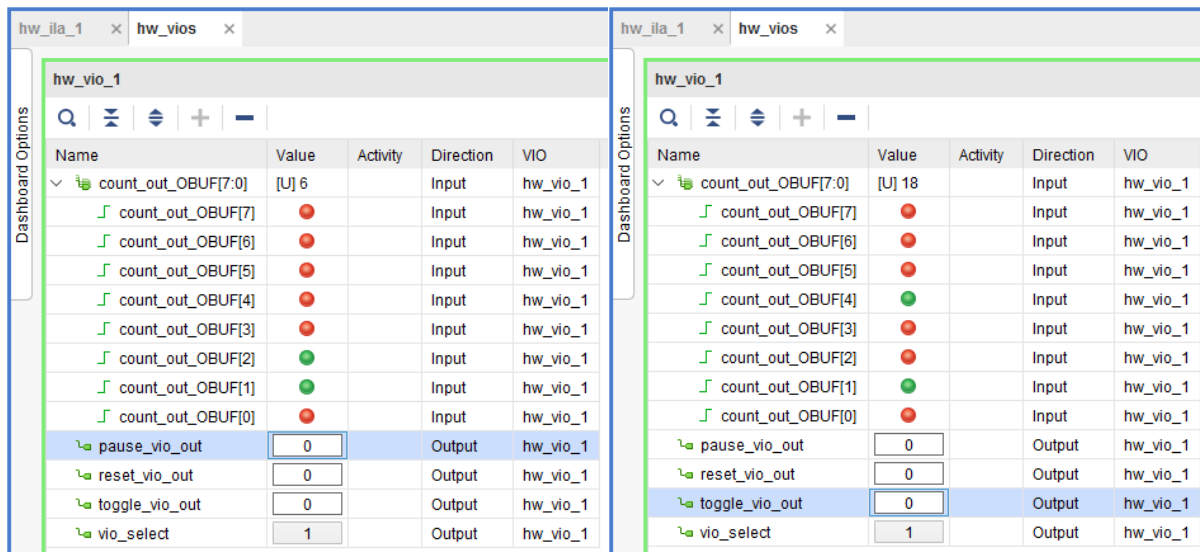

**Figure 78: The add function in action**

22. Switch to the ILA dashboard. In the trigger setup window click + and add my\_math/outtemp2[5:0] bus. Change the following settings for the trigger

Radix = unsigned decimal

Value = 30

23. In the ILA settings window change the trigger position to 512.

24. In the waveform window, click the + button and add the my\_math/outtemp2[5:0] bus to the waveform. Right click on the probe and change the radix to unsigned decimal.
25. In the waveform window click the trigger button for the ILA. You will see the transition from 27 (9+9+9) to 30 (10+10+10) (Note: Make sure the VIO does not have the design paused, or you will be waiting a long time for the trigger to occur)

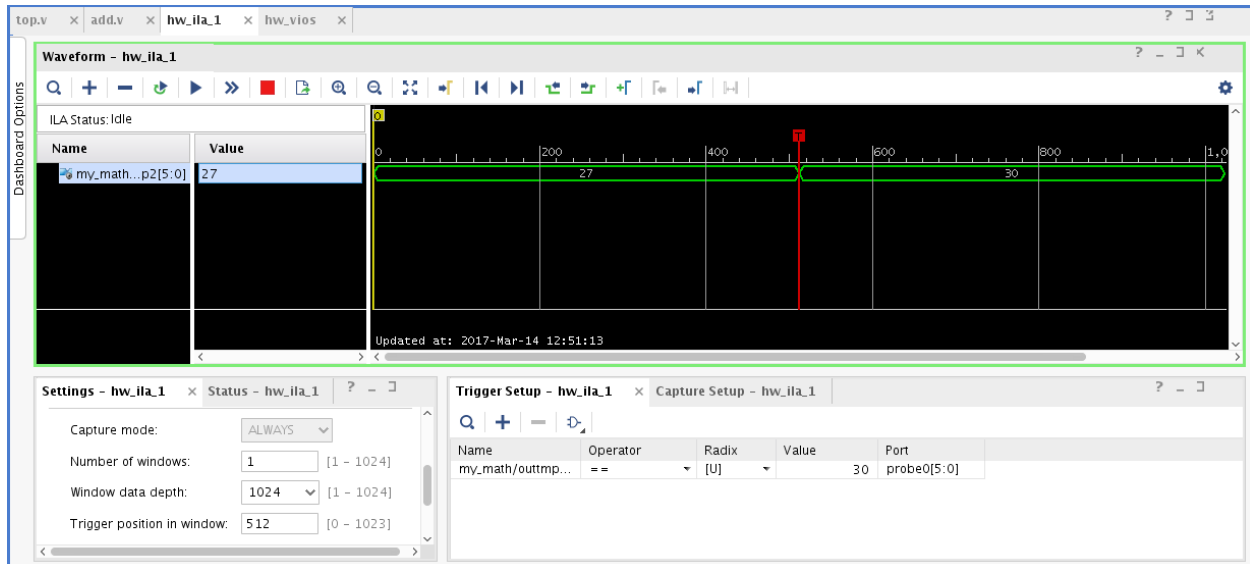

**Figure 79: Watching the add function**

Close the Hardware Manager when you are satisfied that everything is functioning properly.

## Conclusion

With the addition of RM-level debug, any part of a Partial Reconfiguration design is debuggable. Users can easily switch between different RMs within the Hardware Manager to monitor design activity just as you would in a flat design.

## Lab 5: Partial Reconfiguration Controller IP for 7 Series Devices

### Step 1: Extracting the Tutorial Design Files



1. To obtain the tutorial design file, see Tutorial Design Description.
2. Navigate to `\prc_7s` in the extracted files. The `prc_7s` data directory is referred to throughout the lab as the `<Extract_Dir>`.

### Step 2: Customizing the Partial Reconfiguration Controller IP

The PRC IP requires a few details to be entered during the customization process. Identifying all information regarding each Reconfigurable Partition (RP) and Reconfigurable Module (RM) creates a fully populated controller that understands the entirety of the reconfiguration needs of the target FPGA. Within this IP, reconfigurable portions of the design are referred to as Virtual Sockets, which encompasses the RP along with all associated static logic used to manage it, such as decoupling or handshaking logic. While the core parameters are customizable during operation, the more that can be entered during this step, the better. This allows the front-end design description to more accurately match the final implemented design.

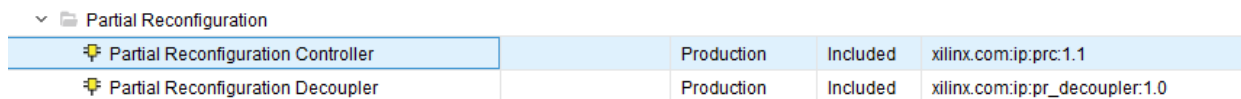
1. Open the Vivado IDE and click the **Manage IP** task, and select **New IP Location**. Enter the following details before clicking **Finish**:
  - Part: Click on **Boards** to select your target. This lab supports the KC705, VC707 and VC709.
  - IP Location: `<Extract_Dir>/Sources/lab`
2. In the **IP Catalog**, expand the Partial Reconfiguration category to double-click on the Partial Reconfiguration Controller IP.



Partial Reconfiguration				
 Partial Reconfiguration Controller		Production	Included	xilinx.com:ip:prc:1.1
 Partial Reconfiguration Decoupler		Production	Included	xilinx.com:ip:pr_decoupler:1.0

**Figure 80: The Partial Reconfiguration Controller as shown in the IP Catalog**

The PR Controller IP GUI has four tabs on the left side, providing feedback on the current configuration of the IP. The default pane is labeled Validation, and shows any errors that might arise as the core parameters are entered. The core does not compile if errors exist.



There are two tabs on the right side of the GUI where all customization is done. Most of the information is entered on the **Virtual Socket Manager Options** tab.

3. Change the component name from **prc\_0** to **prc**, to match the component name in the supplied VHDL top level.
4. On the Global Options tab, make three changes:
  - a. **Set the polarity of reset and icap\_reset = 1**
  - b. **Specify the CAP arbitration protocol = 1) Latency has not been added to arbiter signals**
  - c. **Specify the number of Clock domain crossing stages = 2**

Make sure that the **Managed device type** is set to 7 Series. The PRC GUI should now look like this:

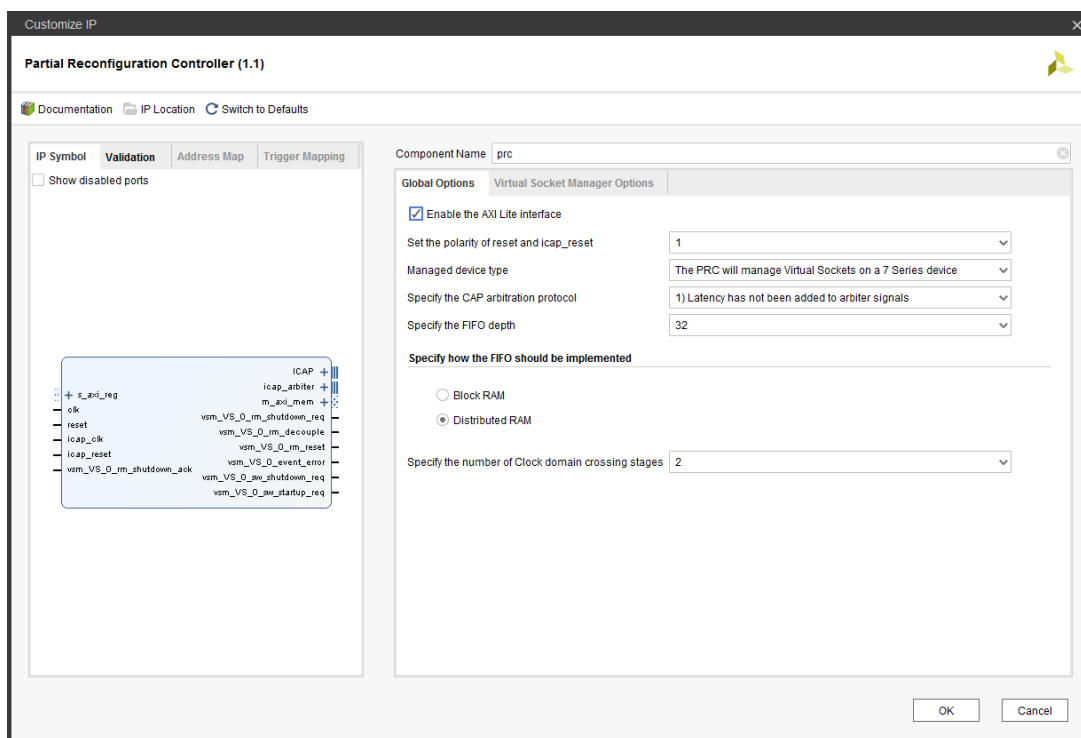

**Figure 81: Component Name and Global Options completed**

Note that this PR Controller can manage Virtual Sockets on 7 series, UltraScale, UltraScale+ devices. This IP is not limited to managing PR on the same device on which it resides. It can connect to an ICAP on another device to manage its reconfiguration.

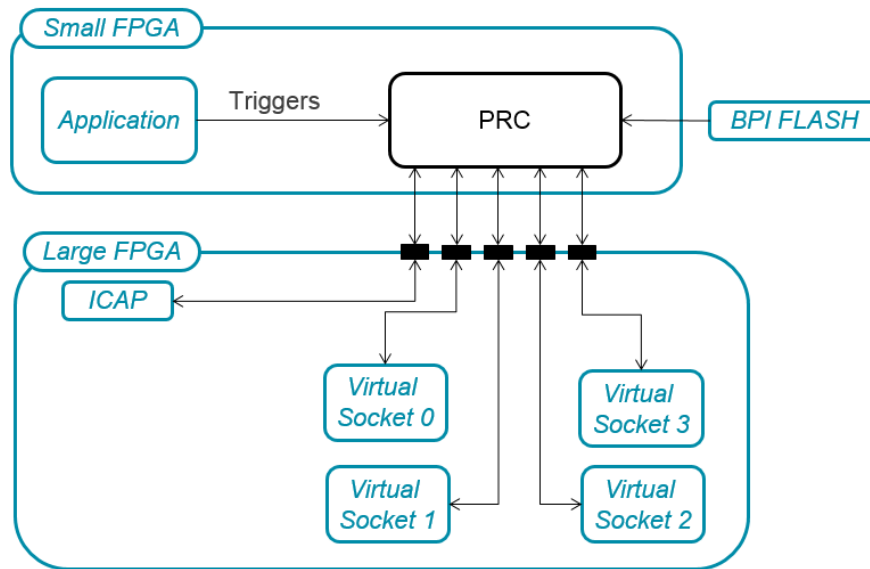

Figure 82: Example of a multi-chip solution using the PRC

- Next, switch to the **Virtual Socket Manager Options** tab to define information about the Virtual Sockets and their Reconfigurable Modules.

The PRC IP is preloaded with one Virtual Socket with one Reconfigurable Module to get you started.

First, define the Virtual Socket Manager (VSM) for the Shift functionality.

- Rename the current VSM from **VS\_0** to **vs\_shift** in the **Virtual Socket Name** field.
- Rename the current RM from **RM\_0** to **rm\_shift\_left** in the **Reconfigurable Module Name** field.

**CAUTION!**



- Underscores are not visible in the Virtual Socket Manager and Reconfigurable Module pull-down dialogs. The **Name** (ID) label below the pull-down shows this more accurately.
- To accept a new value in any field in the GUI, simply click in any other field in the GUI or press the Tab key. Do NOT press Enter, as this will trigger compilation of the IP.

- Click the **New Reconfigurable Module** button to create a new RM for this VSM. Name it **rm\_shift\_right**.



**TIP:** Up to 128 Reconfigurable Modules can be managed by a single Virtual Socket Manager.

9. Configure the vs\_shift VSM to have the following properties:

- **Has Status Channel = checked**
- **Has PoR RM = rm\_shift\_right**
- **Number of RMs allocated = 4**

The PoR RM indicates which RM is contained within the initial full-design configuration file, so the VSM knows which triggers and events are appropriate upon startup of the FPGA. The VSM tracks the current active Reconfigurable Module in its socket.

Even though you have only defined two RMs for this Virtual Socket, you have set aside space for four in total. This allows for expansion later on. Additional Reconfigurable Modules can be identified using the AXI4-Lite interface, but only if spaces have been reserved for them.

10. For each of these RMs, enter the following values. Use the **Reconfigurable Module to configure** pull-down to switch between the two RMs.

- For `rm_shift_left`:
  - **Reset type = Active High**
  - **Duration of Reset = 3**
- For `rm_shift_right`:
  - **Reset type = Active High**
  - **Duration of Reset = 10**

***Note:** The different reset durations are given to show that these can be independently assigned, as each RM may have different requirements. Reset durations are measured in clock cycles.*

11. For each RM, assign a bitstream size and location to identify where it will reside in the BPI flash device. These values differ based on the target board.

- When targeting the KC705:
  - For `rm_shift_left`:
    - **Bitstream 0 address = 0x00AEA000**
    - **Bitstream 0 size (bytes) = 482828**
  - For `rm_shift_right`:
    - **Bitstream 0 address = 0x00B60000**
    - **Bitstream 0 size (bytes) = 482828**

- When targeting the VC707:
  - For `rm_shift_left`:
    - **Bitstream 0 address = 0x01355C00**
    - **Bitstream 0 size (bytes) = 708260**
  - For `rm_shift_right`:
    - **Bitstream 0 address = 0x01402C00**
    - **Bitstream 0 size (bytes) = 708260**
- When targeting the VC709:
  - For `rm_shift_left`:
    - **Bitstream 0 address = 0x00800000**
    - **Bitstream 0 size (bytes) = 889252**
  - For `rm_shift_right`:
    - **Bitstream 0 address = 0x008D9400**
    - **Bitstream 0 size (bytes) = 889252**

This information is typically not known early in design cycles, as bitstream size is based on the size and composition of the Reconfigurable Partition Pblock, and bitstream address is based on storage details. Until the design is to be tested on silicon, these can be set to 0. As the design settles and hardware testing with the PRC is set to begin, this information can be added. The bitstream address information must match the information passed during PROM file generation. Certain bitstream generation options, most notably bitstream compression, can lead to variations in the final bitstream size for different configurations, even for the same Reconfigurable Partition.

12. Define the **Trigger Options** for the Shift functionality:

- **Number of Hardware Triggers = 4**
- **Number of Triggers allocated = 4**

The four trigger assignments are done automatically. These can be modified during device operation using AXI4-Lite, which is especially useful when you have added a new RM through the same mechanism during a field system upgrade.

At this point, the IP GUI should look like this (showing `rm_shift_left` here):

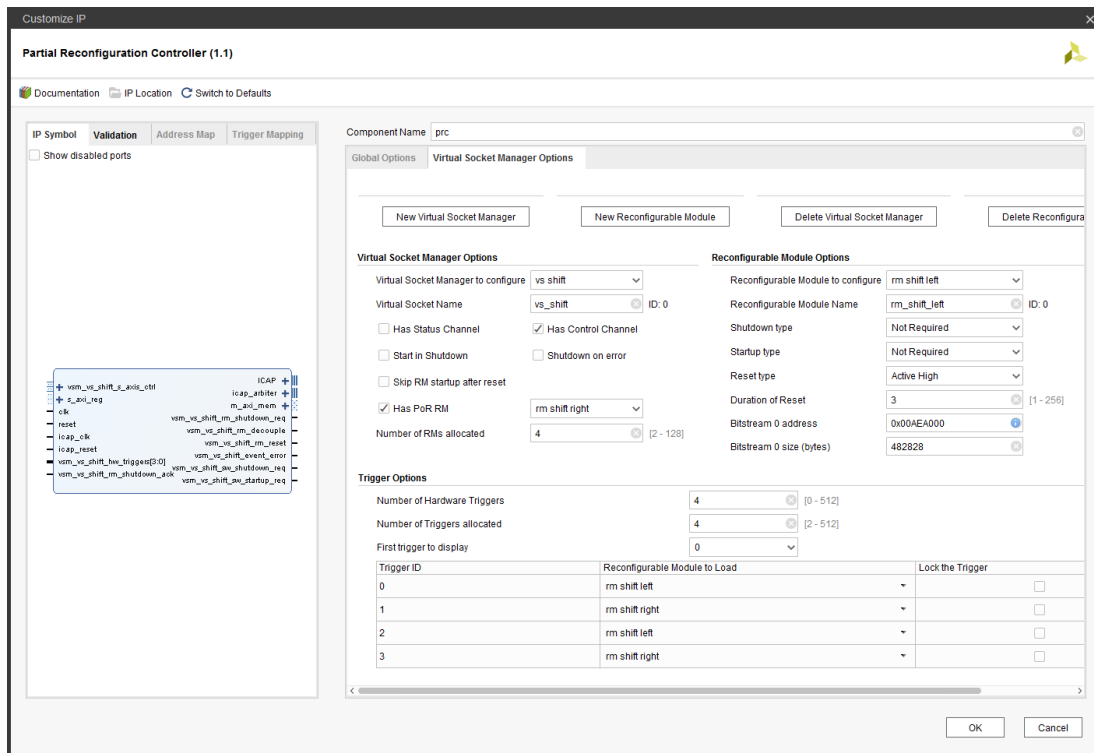

Figure 83: VSM vs\_shift completed

Next, you will create and populate the Count Virtual Socket following the same basic steps, with slightly different options.

13. Click the **New Virtual Socket Manager** button to create a new VSM.
14. Select the **New Reconfigurable Module** button to add two RMs with these names and properties:
  - **RM Name** = `rm_count_up`
    - **Reset type** = **Active High**
    - **Duration of Reset** = **12**
  - **RM Name** = `rm_count_down`
    - **Reset type** = **Active High**
    - **Duration of Reset** = **16**

For this Virtual Socket, leave the bitstream address and size information at the default of 0. In addition to being defined here, bitstream size information can be added to a routed configuration checkpoint via the PRC Tcl API, or can be added in an active design using the AXI4-Lite interface. For the Count Virtual Socket, the bitstream address and size information is added using the Tcl commands after place and route, but before bitstream generation.



**TIP:** For more information about how to use the PRC Tcl API, see this [link](#) in the Partial Reconfiguration Controller Product Guide (PG193).

Examine the Tcl scripts in the <Extract\_Dir>/Sources/scripts directory and find the calls to the PRC Tcl API. The Tcl calls (which have been referenced by design.tcl) can be found in one script (update\_prc.tcl) and the sizes themselves are stored in another (pr\_info.tcl).

15. Modify these VSM settings from their default values:

- Virtual Socket Manager name = **vs\_count**
- Start in Shutdown = **checked**
- Shutdown on error = **unchecked**
- Has PoR RM = **checked, rm\_count\_up**

16. Define the Trigger Options for the Count functionality:

- Number of Hardware Triggers = **4**
- Number of Triggers allocated = **4**

This completes the planned customization of the PRC IP for this tutorial.

17. Click **OK** and then **Generate** to begin core compilation and out-of-context synthesis.

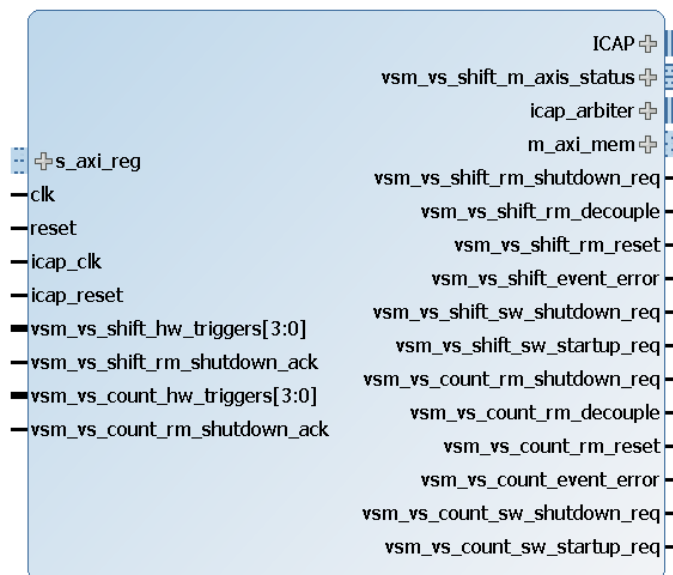

Figure 84: Final PRC symbol

## Step 3: Compiling the Design

The PR Controller IP is created, but the design is not yet compiled, which could take approximately an hour. In order to create the PROM image with all the necessary full and partial images, source the following scripts in Tcl mode using the commands below.



**IMPORTANT:** Before running this Tcl script, open it to set the value of the `xboard` variable. `KC705` is the default, but `VC707` or `VC709` can be selected.

```
1. vivado -mode tcl -source design.tcl
```

Sourcing `design.tcl` generates all the necessary IP (including the PRC), synthesizes and implements the entire design (three configurations), updates the `vs_count` VSM using the PRC Tcl API, and generates bitstreams.

Note that the customization of the IP is scripted. Examine the `gen_ip_<board>.tcl` script (in `<Extract_Dir>/Sources/scripts`) to see all these parameters defined for automated IP creation, the PRC, and others. The PRC instance you create using the IP GUI is not actually used for the full design processing, so you do not have to complete Section 1 to compile the entire design.

```
2. vivado -mode tcl -source create_prom_file_<board>.tcl
```

Sourcing `create_prom_file.tcl` creates the PROM image for the target board. This script contains hard-coded values for bitstream address for the entire project. If this design is modified in such a way that changes bitstream sizes, full or partial, then these values must also change. Changes that affect bitstream sizes include changing the target device, changing the size or shape of the Pblocks, or introducing bitstream options such as compression or per-frame CRC.

This script defines PROM file options by setting properties and then making calls to `write_cfgmem`. The PRC works in byte addresses because the data is stored in bytes in AXI. This linear flash PROM uses half word addresses because it stores data in half words (16 bits). Divide the ROM address by 2 to get the AXI address. For example, the `shift_left` address for the `KC705` is given as `00AEA000` in during PRC customization and `00575000` (half that value) for `write_cfgmem`. Note that the starting addresses are always multiples of 1024 (`0x0400`) to ensure that each bitstream starts on a byte address boundary. Also note that the initial configuration file for the `VC709` is compressed in order to fit in the linear flash; the address for the first partial bitstream that follows is padded to allow expansion of that initial configuration file.

Supplied in the lab directory is a file called `prc_bitstream_sizes.xlsx`. In this file, bitstream sizes are entered by the user based in the yellow highlighted fields. It calculates the starting address in hex for each partial bitstream at the next byte boundary. Values in blue are to be supplied for PR Controller IP customization, in either the PRC IP GUI, in the `gen_ip_<board>.tcl` script, or in `pr_info_<board>.tcl` which is used for post-route API modification. The values in green are addresses divided by two to be used in PROM file generation in the `create_prom_file_<board>.tcl` script.

---

## Step 4: Setting up the Board

Once the partially reconfigurable design is in operation, you can connect to and communicate with the core to check status, deliver triggers and make modifications.

1. Prepare the target board for programming.
  - a. Connect the JTAG port to your computer via the micro-USB connection.
    - For the KC705: U59
    - For the VC707 or VC709: U26
  - b. Set the configuration mode to 010 (BPI) by setting the Address DIP Switch (SW13) to 00010 (bit 4 is high).
  - c. Turn on the power to the board.
2. Open the Vivado IDE.
3. Select **Flow > Open Hardware Manager**
4. Click on the **Open Target** link and select **Auto Connect** for the device to be recognized.
5. To program the BPI configuration flash, right-click the device (e.g. **xc7k325t\_0**) and select **Add Configuration Memory Device**.
6. From the list shown, select the appropriate linear BPI flash and click **OK** twice.
  - For the KC705, select **28f00ap30t**
  - For the VC707 or VC709, select **28f00ag18f**
7. In the **Configuration file** field, search the tutorial directory for `pr_prom.mcs` found in the bitstreams subdirectory. Click **OK** to select this file, and then click **OK** to program the flash.

At this point, the board is ready to operate with the tutorial design. Any power-cycle or hard reset automatically programs the Xilinx FPGA with this sample design.



## Step 5: Operating the Sample Design

Position the board so that the text is readable. The LCD screen is on the side closest to you, with the power connection on the right and the JTAG connection on the left. The buttons of interest are the five user push buttons in the lower right corner, plus the **PROG** push button in the middle right.

Their functions for the KC105 are as follows:

- PROG (SW14) – program the device from the BPI flash
- North (SW2) – load the Count Up partial bit file
- South (SW4) – load the Count Down partial bit file
- East (SW3) – load the Shift Right partial bit file
- West (SW6) – load the Shift Left partial bit file
- Center (SW5) – reset the design

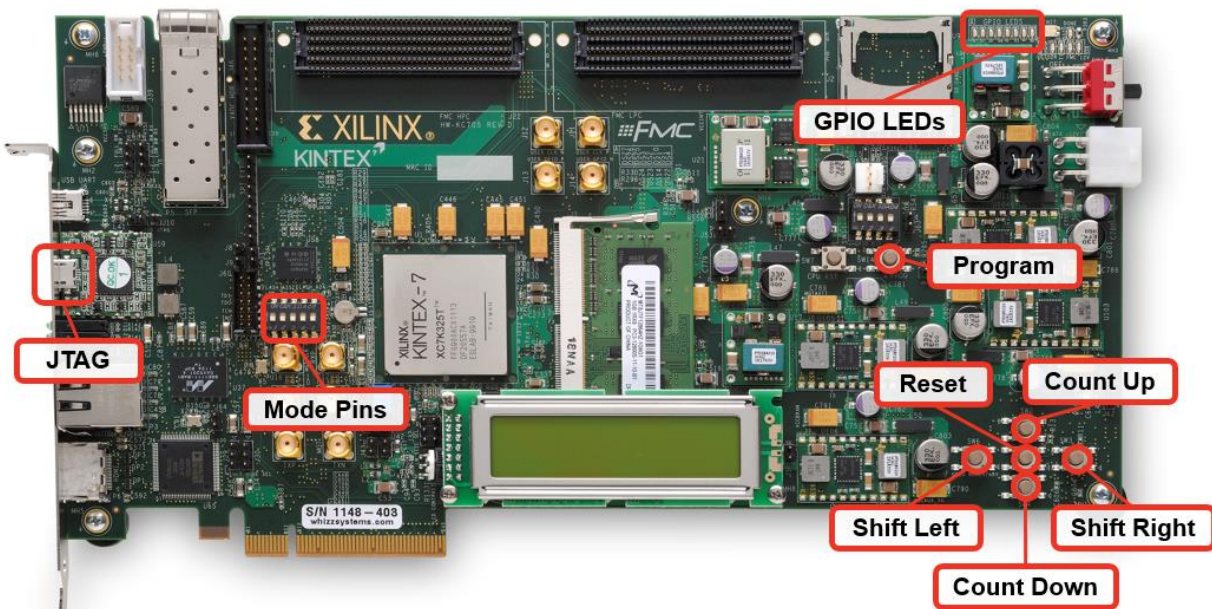

Figure 85: Push buttons, switches and connections on the KC705 demonstration board

Their functions for the VC707 and VC709 are as follows:

- PROG (SW9) – program the device from the BPI flash
- North (SW3) – load the Count Up partial bit file
- South (SW5) – load the Count Down partial bit file
- East (SW4) – load the Shift Right partial bit file
- West (SW7) – load the Shift Left partial bit file
- Center (SW6) – reset the design

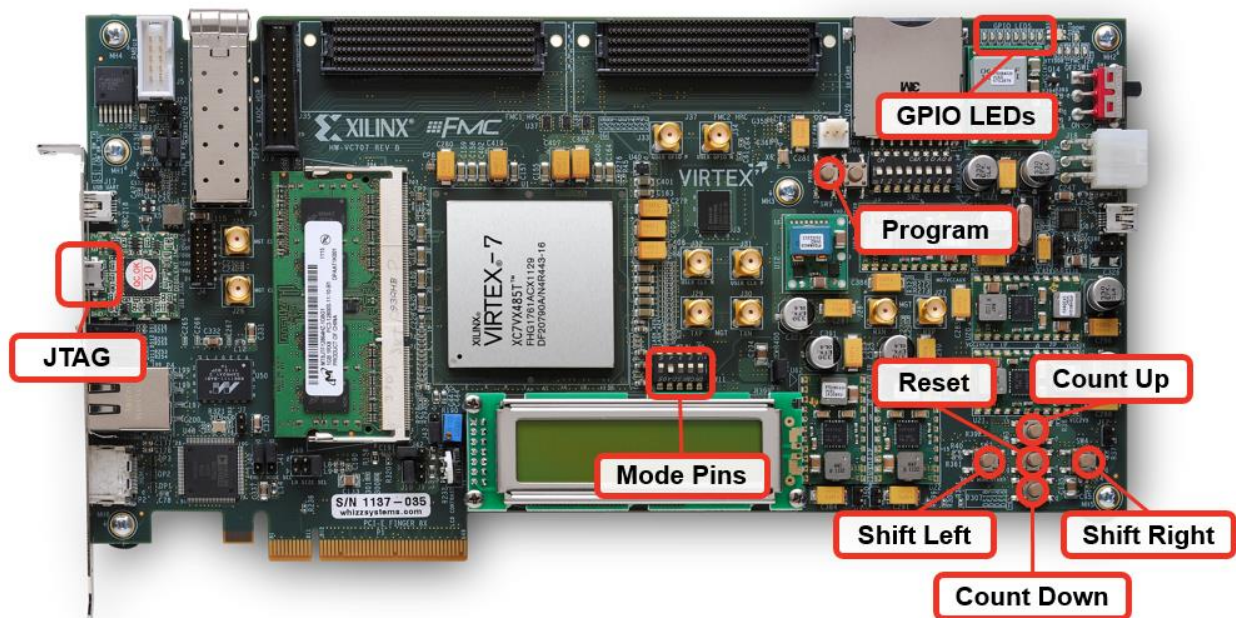
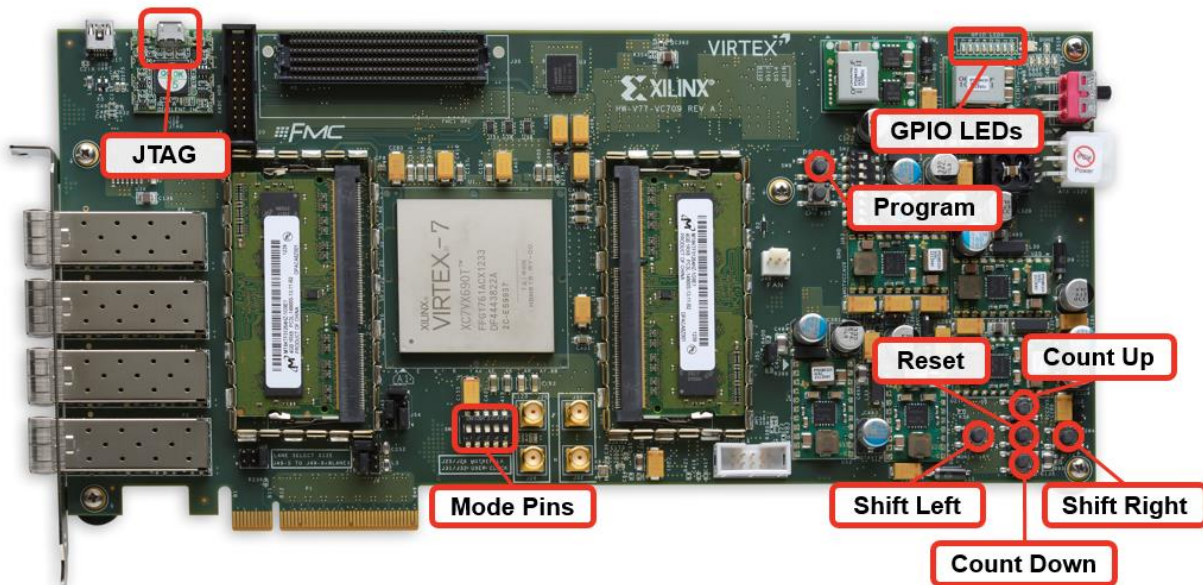

Figure 86: Push buttons, switches and connections on the VC707 demonstration board



**Figure 87: Push buttons, switches and connections on the VC709 demonstration board**

1. Program the FPGA by pressing the **PROG** pushbutton. The 8 GPIO LEDs in the upper-right corner will start operation after the DONE LED goes high.  
At this point, the four bits on the left of the GPIO bank are counting up, and the four bits on the right are shifting to the right.
2. Press the **Shift Left** and **Shift Right** buttons alternately.  
With each push, a partial bit file is pulled from the BPI flash by the PRC and delivered to the ICAP, changing the functionality in that Reconfigurable Partition. When this happens, the LED shift direction changes, depending on the button pushed.
3. Press the **Count Down** and **Count Up** buttons alternately.  
With each push, nothing happens. When configuring the PR Controller, the Counter Virtual Socket was programmed to begin in Shutdown mode. It does not respond to any hardware or software triggers until it is moved to Active mode.

## Step 6: Querying the PRC in the FPGA

In this step, you interact with the core via JTAG from the Hardware Manager to understand the status of the core and issue software triggers.

In the Vivado Hardware Manager, you might need to select **Refresh Device** to establish the link to the device over the JTAG connection. Notice the XADC as well as 6 ILA cores and the `hw_axi` link shown under the device in the Hardware view.

1. In the Tcl Console, cd into the PRC tutorial directory then source the AXI4-Lite command Tcl script.

```
source ./Sources/scripts/axi_lite_procs.tcl
```

This enables a set of procedures that make the subsequent interaction with the PRC easier. Examine this file to see how these procedures are defined. Note that these are written explicitly (hard-coded) for this design, the references to Virtual Sockets in any other design will need to be modified. For more information on this topic, consult the *Partial Reconfiguration Controller Product Guide* ([PG193](#)).

2. Source the procedure to establish communication with the PRC.

```
prc_jtag_setup
```

3. Check the state of each Virtual Socket to see if they are in Shutdown or not.

```
is_vsm_in_shutdown vs_shift
is_vsm_in_shutdown vs_count
```

You should see that the Shift Virtual Socket is in Active mode (value = 0), and the Count Virtual Socket is in Shutdown mode (value = 1).

4. Examine the status of each Virtual Socket.

```
prc_decode_status vs_shift
prc_decode_status vs_count
```

Before examining the data returned, reference Table 2-4 in this [link](#) of the *Partial Reconfiguration Controller Product Guide* ([PG193](#)). The table in that section defines the values in the STATUS register. While this is a 32-bit register, you only need to pay attention to the lowest 24 bits, as the upper 8 bits are used for Virtual Socket Managers (VSM) in UltraScale devices.

The status of `vs_shift` is 263, which is 0000\_0000\_0000\_0001\_0000\_0111 in binary. The status for `vs_shift` may also be 7, where the only difference is that `RM_ID` is now 0.

- `RM_ID` (bits 23:8) = 1. This means RM 1 is loaded (`rm_shift_right`). It may also appear as `RM_ID` (bits 24:8) = 0. This means RM 0 is loaded (`rm_shift_left`).
- `SHUTDOWN` (bit 7) = 0. This VSM is not in the shutdown state.
- `ERROR` (bits 6:3) = 0000. There are no errors.
- `STATE` (bits 2:0) = 111. The Virtual Socket is full.

The status of `vs_count` is 129, which is 0000\_0000\_0000\_0000\_1000\_0001 in binary.

- `RM_ID` (bits 23:8) = 0. This means RM 0 is loaded (`rm_count_up`).
- `SHUTDOWN` (bit 7) = 1. This VSM is in the shutdown state.
- `ERROR` (bits 6:3) = 0000. There are no errors.
- `STATE` (bits 2:0) = 001. `RM_SHUTDOWN_ACK` is 1, as this VSM is executing the hardware shutdown step.

These explicit details are reported in the breakdown of the status register in the return value from this Tcl proc.

5. Send a software trigger to the Shift Virtual Socket.

```
prc_send_sw_trigger vs_shift 0  
prc_send_sw_trigger vs_shift 1
```

Remember that values of 0 and 2 correspond to shift left, and values of 1 and 3 correspond to shift right, as defined during PRC customization.

6. Check the configurations of the RMs for the Count Virtual Socket.

```
prc_show_rm_configuration vs_count 0  
prc_show_rm_configuration vs_count 1
```

The values for the bitstream sizes and address are reported here. These values could then be modified to account for necessary adjustments to the size or location of the bitstream.

Different indices can be added to insert new RMs. Note that this query cannot be done for `vs_shift`, as the `vs_shift` VSM is not in the shutdown state.

7. Move the Count Virtual Socket Manager into active mode.

```
prc_restart_vsm_no_status vs_count
```

The Count Up and Count Down pushbuttons can now be used to load these partial bitstreams using the PR Controller.

---

## Step 7: Modifying the PRC in the FPGA

In the final step, you add a new Reconfigurable Module to the Shifter VSM. In the `create_prom.tcl` script, you can see that two black box modules have already been generated. These represent two new RMs that may have been created after the static design was deployed to the field. You modify the PRC settings to access one of these RMs by assigning the size, address, properties and trigger conditions.

1. Shut down the Shift VSM so it can be modified.

```
prc_shutdown_vsm vs_shift
```

2. Check the status of the first three RM IDs to see their register bank assignments.

```
prc_show_rm_configuration vs_shift 0  
prc_show_rm_configuration vs_shift 1  
prc_show_rm_configuration vs_shift 2
```

Currently, RM ID 2 has the same mapping as RM ID 0, so the same shift left partial bitstream would be loaded. This is the behavior as requested when the initial trigger mapping was done during core customization.

3. When the MCS file is created for the prom, it adds additional blanking RMs that are already loaded into the BPI flash. Use this sequence of commands to reassign the trigger mapping for slot 2 to point to the blanking Reconfigurable Module for `vs_shift`.

```
prc_write_register vs_shift_rm_control2 0
```

This defines the settings for the `RM_CONTROL` register for slot 2. No shutdown, startup, or reset are required. Note how for the other two slots, the differing reset durations lead to different control values.

```
prc_write_register vs_shift_rm_bs_index2 2
```

This assigns a new bitstream reference for this RM ID.

```
prc_write_register vs_shift_trigger2 2
```

This assigns the trigger mapping such that trigger index 2 retrieves RM 2.

```
prc_show_rm_configuration vs_shift 2
```

This shows the current state of RM ID 2. Note the changes from the prior call to this command.

4. Complete the RM ID 2 customization by setting the bitstream details.

For the KC705:

```
prc_write_register vs_shift_bs_size2 482828  
prc_write_register vs_shift_bs_address2 13496320
```

For the VC707:

```
prc_write_register vs_shift_bs_size2 708260  
prc_write_register vs_shift_bs_address2 23108608
```

For the VC709:

```
prc_write_register vs_shift_bs_size2 889252  
prc_write_register vs_shift_bs_address2 11960320
```

5. Restart the VSM and then issue trigger events to it using software, as there is no pushbutton assigned for slot 2.

```
prc_restart_vsm_no_status vs_shift  
prc_send_sw_trigger vs_shift 2
```

Switch between values of 0, 1 and 2 to reload different partial bitstreams.

Note that this same sequence of events could not be performed for the Count VSM as it is currently configured, even knowing that the PROM image has a Count black box partial bitstream sitting at (for the KC705) address 13979648 with a size of 541812. During PRC customization, this VSM was selected to have only 2 RMs allocated, so expansion is not permitted.

## Conclusion

This concludes lab 5. In this lab, you:

- Customized the Partial Reconfiguration Controller IP.
- Created a Virtual Sockets and added RMs to them.
- Compiled the design and created a PROM file.
- Programmed the linear flash on the KC705, VC707 or VC709 board.
- Used pushbuttons to issue hardware triggers.
- Used the AXI-Lite interface to check the core status and issue software triggers.
- Added a new RM to an already deployed design.

## Lab 6: Partial Reconfiguration Controller IP for UltraScale Devices

### Step 1: Extracting the Tutorial Design Files

1. To obtain the tutorial design file, see Tutorial Design Description.
2. Navigate to \prc\_us in the extracted files. The prc\_us data directory is referred to throughout the lab as the <Extract\_Dir>.

### Step 2: Customizing the Partial Reconfiguration Controller IP

The PRC IP requires a few details to be entered during the customization process. Identifying all information regarding each Reconfigurable Partition (RP) and Reconfigurable Module (RM) creates a fully populated controller that understands the entirety of the reconfiguration needs of the target FPGA. Within this IP, reconfigurable portions of the design are referred to as Virtual Sockets, which encompasses the RP along with all associated static logic used to manage it, such as decoupling or handshaking logic. While the core parameters are customizable during operation, the more that can be entered during this step, the better. This allows the front-end design description to more accurately match the final implemented design.

1. Open the Vivado IDE and click the **Manage IP** task, and select **New IP Location**. Enter the following details before clicking **Finish**:

- Part: Click on **Boards** to select the **VCU108**
- IP Location: <Extract\_Dir>/Sources/lab

**NOTE:** The KCU105 development board is not supported, as the boot flash on this board is a QSPI device. QSPI and sync-mode BPI configuration schemes are not supported for Partial Reconfiguration. See Table 8-1 in this [link](#) of Vivado Design Suite User Guide: Partial Reconfiguration (UG909).

2. In the **IP Catalog**, expand the Partial Reconfiguration category to double-click on the Partial Reconfiguration Controller IP.

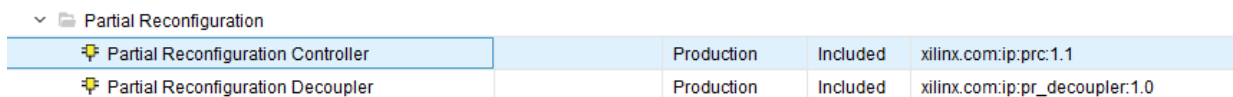

Partial Reconfiguration				
Partial Reconfiguration Controller	Production	Included	xilinx.com:ip:prc:1.1	
Partial Reconfiguration Decoupler	Production	Included	xilinx.com:ip:pr_decoupler:1.0	

Figure 88: The Partial Reconfiguration Controller as shown in the IP Catalog



The PR Controller IP GUI has four tabs on the left side, providing feedback on the current configuration of the IP. The default pane is labeled Validation, and shows any errors that might arise as the core parameters are entered. The core does not compile if errors exist.

There are two tabs on the right side of the GUI where all customization is done. Most of the information is entered on the **Virtual Socket Manager Options** tab.

3. Change the component name from **prc\_0** to **prc**, to match the component name in the supplied VHDL top level.
4. On the Global Options tab, make three changes:
  - a. Set the Polarity of reset and icap\_reset = **1**
  - b. Specify the CAP arbitration protocol = **1) Latency has not been added to arbiter signals**
  - c. Set the number of Clock domain crossing stages = **2**

Make sure that the **Managed device type** is set to UltraScale. The PRC GUI should now look like this:

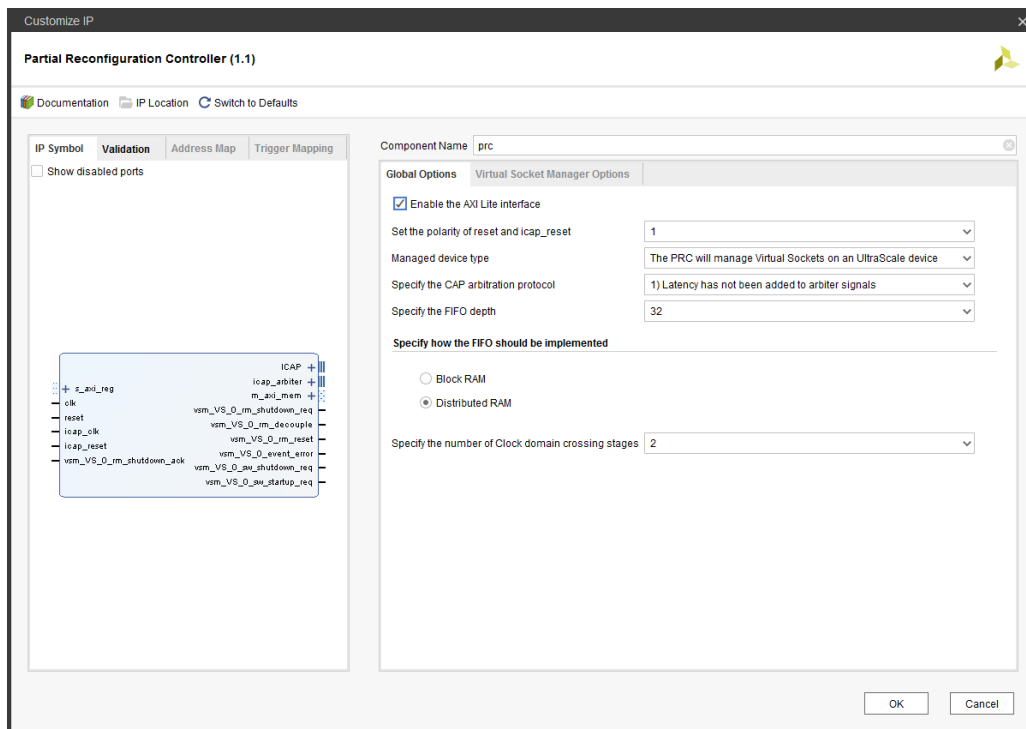

**Figure 89: Component Name and Global Options completed**

Note that this PR Controller can manage Virtual Sockets on 7 series, UltraScale, or UltraScale+ devices. This IP is not limited to managing PR on the same device on which it resides. It can connect to an ICAP on another device to manage its reconfiguration.

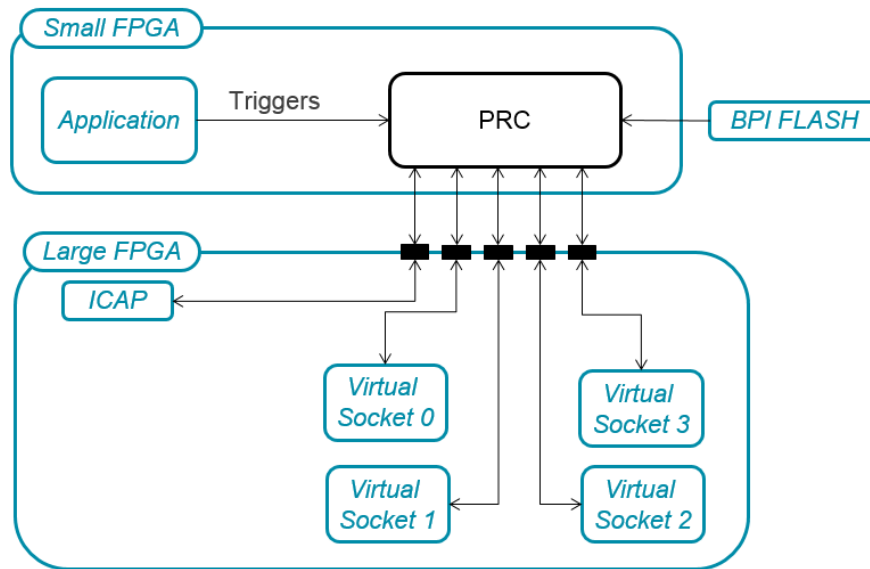

Figure 90: Example of a multi-chip solution using the PRC

- Next, switch to the **Virtual Socket Manager Options** tab to define information about the Virtual Sockets and their Reconfigurable Modules.

The PRC IP is preloaded with one Virtual Socket with one Reconfigurable Module to get you started.

First, define the Virtual Socket Manager (VSM) for the Shift functionality.

- Rename the current VSM from **VS\_0** to **vs\_shift**.
- Rename the current RM from **RM\_0** to **rm\_shift\_left**.

**CAUTION!**

- Underscores are not visible in the Virtual Socket Manager and Reconfigurable Module pull-down dialogs. The **Name (ID)** label below the pull-down shows this more accurately.
- To accept a new value in any field in the GUI, simply click in any other field in the GUI or press the Tab key. Do NOT press Enter, as this will trigger compilation of the IP.



- Click the **New Reconfigurable Module** button to create a new RM for this VSM. Name it **rm\_shift\_right** in the **Reconfigurable Module Name** field.



**TIP:** Up to 128 Reconfigurable Modules can be managed by a single Virtual Socket Manager.

9. Configure the vs\_shift VSM to have the following properties:

- Has Status Channel = **checked**
- Has PoR RM = **rm\_shift\_right**
- Number of RMs allocated = **4**

The PoR RM indicates which RM is contained within the initial full-design configuration file, so the VSM knows which triggers and events are appropriate upon startup of the FPGA. The VSM tracks the current active Reconfigurable Module in its socket.

Even though you have only defined two RMs for this Virtual Socket, you have set aside space for four in total. This allows for expansion later on. Additional Reconfigurable Modules can be identified using the AXI4-Lite interface, but only if spaces have been reserved for them.

10. For each of these RMs, enter the following values. Use the **Reconfigurable Module to configure** pull-down to switch between the two RMs.

- For `rm_shift_left`:
  - Reset type = **Active High**
  - Duration of Reset = **3**
- For `rm_shift_right`:
  - Reset type = **Active High**
  - Duration of Reset = **10**

***Note:** The different reset durations are given to show that these can be independently assigned, as each RM may have different requirements. Reset durations are measured in clock cycles.*

11. For each RM, assign a bitstream size and location to identify where it will reside in the BPI flash device.

- For `rm_shift_left`:
  - Bitstream 0 address = **0x00B00000**
  - Bitstream 0 size (bytes) = **375996**
  - Bitstream 0 is a clearing bitstream = **unchecked**
  - Bitstream 1 address = **0x00B5C000**
  - Bitstream 1 size (bytes) = **26036**
  - Bitstream 1 is a clearing bitstream = **checked**

- For `rm_shift_right`:
  - Bitstream 0 address = **0x00B62800**
  - Bitstream 0 size (bytes) = **375996**
  - Bitstream 0 is a clearing bitstream = **unchecked**
  - Bitstream 1 address = **0x00BBE800**
  - Bitstream 1 size (bytes) = **26036**
  - Bitstream 1 is a clearing bitstream = **checked**

This information is typically not known early in design cycles, as bitstream size is based on the size and composition of the Reconfigurable Partition Pblock, and bitstream address is based on storage details. Until the design is to be tested on silicon, these can be set to 0. As the design settles and hardware testing with the PRC is set to begin, this information can be added. The bitstream address information must match the information passed during PROM file generation. Certain bitstream generation options, most notably bitstream compression, can lead to variations in the final bitstream size for different configurations, even for the same Reconfigurable Partition.

12. Define the Trigger Options for the Shift functionality:

- Number of Hardware Triggers = **4**
- Number of Triggers allocated = **4**

The four trigger assignments are done automatically. These can be modified during device operation using AXI4-Lite, which is especially useful when you have added a new RM through the same mechanism during a field system upgrade.

At this point, the IP GUI should look like this (showing `rm_shift_left` here):

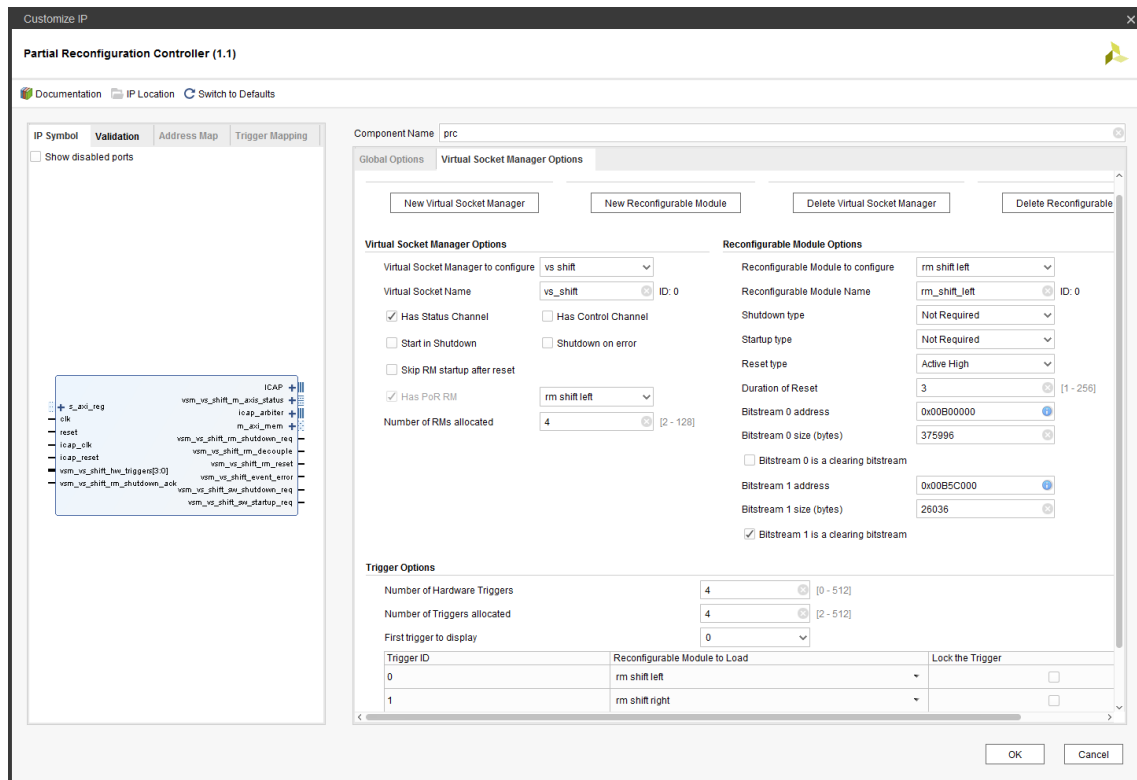

Figure 91: VSM vs\_shift completed

Next, you will create and populate the Count Virtual Socket following the same basic steps, with slightly different options here and there.

13. Click the **New Virtual Socket Manager** button to create a new VSM.

14. Add two RMs with these names and properties:

- RM Name = `rm_count_up`
  - Reset type = **Active High**
  - Duration of Reset = **12**
- RM Name = `rm_count_down`
  - Reset type = **Active High**
  - Duration of Reset = **16**

For this Virtual Socket, leave the bitstream address and size information at the default of 0, but set bitstream 1 to be a clearing bitstream. In addition to being defined here, bitstream size information can be added to a routed configuration checkpoint via the PRC Tcl API, or can be added in an active design using the AXI4-Lite interface. For the Count Virtual Socket, the bitstream address and size information is added using the Tcl commands after place and route, but before bitstream generation.



**TIP:** For more information about how to use the PRC Tcl API, see this [link](#) in the Partial Reconfiguration Controller Product Guide (PG193).

Examine the Tcl scripts in the <Extract\_Dir>/Sources/scripts directory and find the calls to the PRC Tcl API. The Tcl calls (which have been referenced by design.tcl) can be found in one script (update\_prc.tcl) and the sizes themselves are stored in another (pr\_info.tcl).

15. Modify these VSM settings from their default values:

- Virtual Socket Manager name = **vs\_count**
- Start in Shutdown = **checked**
- Shutdown on error = **unchecked**
- Has PoR RM = **checked, rm\_count\_up**

16. Define the Trigger Options for the Count functionality:

- Number of Hardware Triggers = **4**
- Number of Triggers allocated = **4**

This completes the planned customization of the PRC IP for this tutorial.

17. Click **OK** and then **Generate** to begin core compilation and out-of-context synthesis.

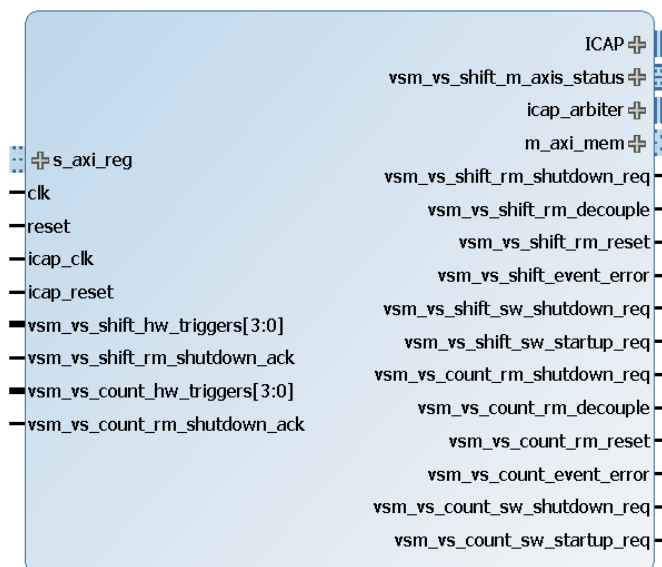

Figure 92: Final PRC symbol

## Step 3: Compiling the Design

The PR Controller IP is created, but the design is not yet compiled, which could take approximately an hour. In order to create the PROM image with all the necessary full and partial images, source the following scripts in Tcl mode using the commands below.

```
1. vivado -mode tcl -source design.tcl
```

Sourcing `design.tcl` generates all the necessary IP (including the PRC), synthesizes and implements the entire design (three configurations), updates the `vs_count` VSM using the PRC Tcl API, and generates bitstreams.

Note that the customization of the IP is scripted. Examine the `gen_ip.tcl` script (in `<Extract_Dir>/Sources/scripts`) to see all these parameters defined for automated IP creation, the PRC, and others. The PRC instance you create using the IP GUI is not actually used for the full design processing, so you do not have to complete Section 1 to compile the entire design.

```
2. vivado -mode tcl -source create_prom_file.tcl
```

Sourcing `create_prom_file.tcl` creates the PROM image for the VCU108 target. This script contains hard-coded values for bitstream address for the entire project. If this design is modified in such a way that changes bitstream sizes, full or partial, then these values must also change. Changes that affect bitstream sizes include changing the target device, changing the size or shape of the Pblocks, or introducing bitstream options such as compression or per-frame CRC.

This script defines PROM file options by setting properties and then making calls to `write_cfgmem`. The PRC works in byte addresses because the data is stored in bytes in AXI. This linear flash PROM uses half word addresses because it stores data in half words (16 bits). Divide the ROM address by 2 to get the AXI address. For example, the `shift_left` address is given as `00B00000` in during PRC customization and `00580000` (half that value) for `write_cfgmem`. Note that the starting addresses are always multiples of 1024 (0x0400) to ensure that each bitstream starts on a byte address boundary.

Supplied in the lab directory is a file called `prc_bitstream_sizes.xlsx`. In this file, bitstream sizes are entered by the user based in the yellow highlighted fields. It calculates the starting address in hex for each partial bitstream at the next byte boundary. Values in blue are to be supplied for PR Controller IP customization, in either the PRC IP GUI, in the `gen_ip.tcl` script, or in `pr_info.tcl` which is used for post-route API modification. The values in green are addresses divided by two to be used in PROM file generation in the `create_prom_file.tcl` script.

## Step 4: Setting up the Board

Once the partially reconfigurable design is in operation, you can connect to and communicate with the core to check status, deliver triggers and make modifications.

1. Prepare the VCU108 board for programming.
  - a. Connect the JTAG port (J106) to your computer via the micro-USB connection.
  - b. Set the configuration mode to 010 (BPI) by setting the Address DIP Switch (SW16) to 00010 (bit 4 is high).
  - c. Turn on the power to the board.
2. Open the Vivado IDE.
3. Select **Flow > Open Hardware Manager**
4. Click on the **Open Target** link and select **Auto Connect**. The Virtex UltraScale VU095 device will be recognized.
5. To program the BPI configuration flash, right-click the device (**xcvu095\_0**) and select **Add Configuration Memory Device**.
6. From the list shown, select the Micron flash **28f00ag18f** and click **OK** twice.
7. In the **Configuration file** field, search the tutorial directory for `pr_prom.mcs` found in the bitstreams subdirectory. Click **OK** to select this file, and then click **OK** to program the flash.

At this point, the board is ready to operate with the tutorial design. Any power-cycle or hard reset automatically programs the Virtex UltraScale FPGA with this sample design.

---

## Step 5: Operating the Sample Design

Position the board so that the text is readable. The LCD screen is on the side closest to you, with the power connection on the right and the JTAG connection on the left. The buttons of interest are the five user push buttons in the lower right corner, plus the **PROG** push button in the middle right. Their functions are as follows:

- PROG (SW4) – program the device from the BPI flash
- North (SW10) – load the Count Up partial bit file
- South (SW8) – load the Count Down partial bit file
- East (SW9) – load the Shift Right partial bit file
- West (SW6) – load the Shift Left partial bit file
- Center (SW7) – reset the design



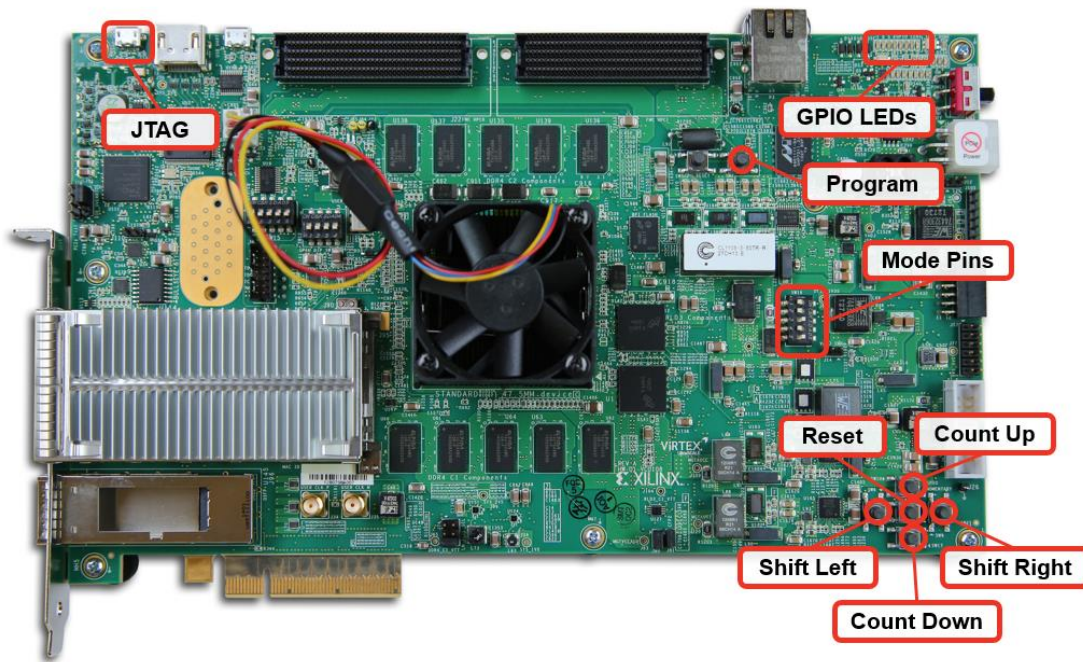

**Figure 93: Push buttons, switches and connections on the VCU108 demonstration board**

8. Program the FPGA by pressing the **PROG** pushbutton. The 8 GPIO LEDs in the upper-right corner will start operation after the DONE LED goes high.  
At this point, the four bits on the left of the GPIO bank are counting up, and the four bits on the right are shifting to the right.
9. Press the **Shift Left** and **Shift Right** buttons alternately.  
With each push, a partial bit file is pulled from the BPI flash by the PRC and delivered to the ICAP, changing the functionality in that Reconfigurable Partition. When this happens, the LED shift direction changes, depending on the button pushed.
10. Press the **Count Down** and **Count Up** buttons alternately.  
With each push, nothing happens. When configuring the PR Controller, the Counter Virtual Socket was programmed to begin in Shutdown mode. It does not respond to any hardware or software triggers until it is moved to Active mode.

## Step 6: Querying the PRC in the FPGA

In this step, you interact with the core via JTAG from the Hardware Manager to understand the status of the core and issue software triggers.

In the Vivado Hardware Manager, you might need to select **Refresh Device** to establish the link to the device over the JTAG connection. Notice the XADC as well as 6 ILA cores and the `hw_axi` link shown under the device in the Hardware view.

1. In the Tcl Console, cd into the PRC tutorial directory then source the AXI4-Lite command Tcl script.

```
source ./Sources/scripts/axi_lite_procs.tcl
```

This enables a set of procedures that make the subsequent interaction with the PRC easier. Examine this file to see how these procedures are defined. Note that these are written explicitly (hard-coded) for this design, the references to Virtual Sockets in any other design will need to be modified. For more information on this topic, consult the *Partial Reconfiguration Controller Product Guide* ([PG193](#)).

2. Source the procedure to establish communication with the PRC.

```
prc_jtag_setup
```

3. Check the state of each Virtual Socket to see if they are in Shutdown or not.

```
is_vsm_in_shutdown vs_shift
is_vsm_in_shutdown vs_count
```

You should see that the Shift Virtual Socket is in Active mode (value = 0), and the Count Virtual Socket is in Shutdown mode (value = 1).

4. Examine the status of each Virtual Socket.

```
prc_decode_status vs_shift
prc_decode_status vs_count
```

Before examining the data returned, reference Table 2-4 in this [link](#) of the *Partial Reconfiguration Controller Product Guide* ([PG193](#)). The table in that section defines the values in the STATUS register. While this is a 32-bit register, you only need to pay attention to the lowest 24 bits, as the upper 8 bits are used for Virtual Socket Managers (VSM) in UltraScale devices.

The status of `vs_shift` is 263, which is 0000\_0000\_0000\_0001\_0000\_0111 in binary. The status for `vs_shift` may also be 7, where the only difference is that `RM_ID` is now 0.

- `RM_ID` (bits 23:8) = 1. This means RM 1 is loaded (`rm_shift_right`). It may also appear as `RM_ID` (bits 24:8) = 0. This means RM 0 is loaded (`rm_shift_left`).
- `SHUTDOWN` (bit 7) = 0. This VSM is not in the shutdown state.
- `ERROR` (bits 6:3) = 0000. There are no errors.
- `STATE` (bits 2:0) = 111. The Virtual Socket is full.

The status of `vs_count` is 129, which is 0000\_0000\_0000\_0000\_1000\_0001 in binary.

- `RM_ID` (bits 23:8) = 0. This means RM 0 is loaded (`rm_count_up`).
- `SHUTDOWN` (bit 7) = 1. This VSM is in the shutdown state.
- `ERROR` (bits 6:3) = 0000. There are no errors.
- `STATE` (bits 2:0) = 001. `RM_SHUTDOWN_ACK` is 1, as this VSM is executing the hardware shutdown step.

These explicit details are reported in the breakdown of the status register in the return value from this Tcl proc.

5. Send a software trigger to the Shift Virtual Socket.

```
prc_send_sw_trigger vs_shift 0  
prc_send_sw_trigger vs_shift 1
```

Remember that values of 0 and 2 correspond to shift left, and values of 1 and 3 correspond to shift right, as defined during PRC customization.

6. Check the configurations of the RMs for the Count Virtual Socket.

```
prc_show_rm_configuration vs_count 0  
prc_show_rm_configuration vs_count 1
```

The values for the bitstream sizes and address are reported here. These values could then be modified to account for necessary adjustments to the size or location of the bitstream. Different indices can be added to insert new RMs. Note that this query cannot be done for `vs_shift`, as the `vs_shift` VSM is not in the shutdown state.

7. Move the Count Virtual Socket Manager into active mode.

```
prc_restart_vsm_no_status vs_count
```

The Count Up and Count Down pushbuttons can now be used to load these partial bitstreams using the PR Controller.

---

## Step 7: Modifying the PRC in the FPGA

In the final step, you add a new Reconfigurable Module to the Shifter VSM. In the `create_prom.tcl` script, you can see that two black box modules have already been generated. These represent two new RMs that may have been created after the static design was deployed to the field. You modify the PRC settings to access one of these RMs by assigning the size, address, properties and trigger conditions.

1. Shut down the Shift VSM so it can be modified.

```
prc_shutdown_vsm vs_shift
```

2. Check the status of the first three RM IDs to see their register bank assignments.

```
prc_show_rm_configuration vs_shift 0  
prc_show_rm_configuration vs_shift 1  
prc_show_rm_configuration vs_shift 2
```

Currently, RM ID 2 has the same mapping as the partial bit file for RM ID 0, so the same shift left partial bitstream would be loaded. This is the behavior as requested when the initial trigger mapping was done during core customization.

3. When the MCS file is created for the prom, it adds additional blanking RMs that are already loaded into the BPI flash. Use this sequence of commands to reassign the trigger mapping for slot 2 to point to the blanking Reconfigurable Module for `vs_shift`.

```
prc_write_register vs_shift_rm_control2 0
```

This defines the settings for the `RM_CONTROL` register for slot 2. No shutdown, startup, or reset are required. Note how for the other two slots, the differing reset durations lead to different control values.

```
prc_write_register vs_shift_rm_bs_index2 327684
```

This assigns a new bitstream reference for this RM ID.

```
prc_write_register vs_shift_trigger2 2
```

This assigns the trigger mapping such that trigger index 2 retrieves RM 2. The `RM_BS_INDEX` register within the PR Controller is 32 bits but is broken into two fields. UltraScale devices require clearing and partial bitstreams. These bitstreams are identified separately with unique IDs, but referenced together in this field.

This value of 327684 converts to 0000000000000101\_000000000000100 in binary. Or more simply, ID 5 for the upper 16 bits for the `CLEAR_BS_INDEX` and ID 4 for the lower 16 bits for the `BS_INDEX`. This assignment sets the clearing and partial bitstream identifiers at the same time.

```
prc_show_rm_configuration vs_shift 2
```

This shows the current state of RM ID 2. Note the changes from the prior call to this command.

4. Complete the RM ID 2 customization by setting the bitstream details.

```
prc_write_register vs_shift_bs_size4 375996  
prc_write_register vs_shift_bs_address4 12935168  
prc_write_register vs_shift_bs_size5 26036  
prc_write_register vs_shift_bs_address5 13312000
```

5. Restart the VSM and then issue trigger events to it using software, as there is no pushbutton assigned for slot 2.

```
prc_restart_vsm_no_status vs_shift  
prc_send_sw_trigger vs_shift 2
```

Switch between values of 0, 1 and 2 to reload different partial bitstreams.

Note that this same sequence of events could not be performed for the Count VSM as it is currently configured, even knowing that the PROM image has a Count black box partial bitstream sitting at address 13338624 with a size of 274104. During PRC customization, this VSM was selected to have only 2 RMs allocated, so expansion is not permitted.

## Conclusion

This concludes lab 6. In this lab, you:

- Customized the Partial Reconfiguration Controller IP.
- Created Virtual Sockets and added RMs to them.
- Compiled the design and created a PROM file.
- Programmed the linear flash on the VCU108 board.
- Used pushbuttons to issue hardware triggers.
- Used the AXI-Lite interface to check the core status and issue software triggers.
- Added a new RM to an already deployed design.

---

## Please Read: Important Legal Notices

The information disclosed to you hereunder (the "Materials") is provided solely for the selection and use of Xilinx products. To the maximum extent permitted by applicable law: (1) Materials are made available "AS IS" and with all faults, Xilinx hereby DISCLAIMS ALL WARRANTIES AND CONDITIONS, EXPRESS, IMPLIED, OR STATUTORY, INCLUDING BUT NOT LIMITED TO WARRANTIES OF MERCHANTABILITY, NON-INFRINGEMENT, OR FITNESS FOR ANY PARTICULAR PURPOSE; and (2) Xilinx shall not be liable (whether in contract or tort, including negligence, or under any other theory of liability) for any loss or damage of any kind or nature related to, arising under, or in connection with, the Materials (including your use of the Materials), including for any direct, indirect, special, incidental, or consequential loss or damage (including loss of data, profits, goodwill, or any type of loss or damage suffered as a result of any action brought by a third party) even if such damage or loss was reasonably foreseeable or Xilinx had been advised of the possibility of the same. Xilinx assumes no obligation to correct any errors contained in the Materials or to notify you of updates to the Materials or to product specifications. You may not reproduce, modify, distribute, or publicly display the Materials without prior written consent. Certain products are subject to the terms and conditions of Xilinx's limited warranty, please refer to Xilinx's Terms of Sale which can be viewed at <http://www.xilinx.com/legal.htm#tos>; IP cores may be subject to warranty and support terms contained in a license issued to you by Xilinx. Xilinx products are not designed or intended to be fail-safe or for use in any application requiring fail-safe performance; you assume sole risk and liability for use of Xilinx products in such critical applications, please refer to Xilinx's Terms of Sale which can be viewed at <http://www.xilinx.com/legal.htm#tos>.

### **AUTOMOTIVE APPLICATIONS DISCLAIMER**

AUTOMOTIVE PRODUCTS (IDENTIFIED AS "XA" IN THE PART NUMBER) ARE NOT WARRANTED FOR USE IN THE DEPLOYMENT OF AIRBAGS OR FOR USE IN APPLICATIONS THAT AFFECT CONTROL OF A VEHICLE ("SAFETY APPLICATION") UNLESS THERE IS A SAFETY CONCEPT OR REDUNDANCY FEATURE CONSISTENT WITH THE ISO 26262 AUTOMOTIVE SAFETY STANDARD ("SAFETY DESIGN"). CUSTOMER SHALL, PRIOR TO USING OR DISTRIBUTING ANY SYSTEMS THAT INCORPORATE PRODUCTS, THOROUGHLY TEST SUCH SYSTEMS FOR SAFETY PURPOSES. USE OF PRODUCTS IN A SAFETY APPLICATION WITHOUT A SAFETY DESIGN IS FULLY AT THE RISK OF CUSTOMER, SUBJECT ONLY TO APPLICABLE LAWS AND REGULATIONS GOVERNING LIMITATIONS ON PRODUCT LIABILITY.

© Copyright 2012-2017 Xilinx, Inc. Xilinx, the Xilinx logo, Artix, ISE, Kintex, Spartan, Virtex, Zynq, and other designated brands included herein are trademarks of Xilinx in the United States and other countries. All other trademarks are the property of their respective owners.