

Introduction

The AXI (Advanced eXtensible Interface) Central Direct Memory Access (AXI CDMA) core is a soft Xilinx IP core for use with the Xilinx® Embedded Development Kit (EDK). The AXI CDMA provides high-bandwidth direct memory access (DMA) between a memory mapped source address and a memory mapped destination address using the AXI4 protocol. An optional Scatter Gather (SG) feature can be used to offload control and sequencing tasks from the System CPU. Initialization, status, and control registers are accessed through an AXI4-Lite slave interface, suitable for the Xilinx MicroBlaze™ microprocessor.

Features

- Independent AXI4-Lite Slave interface for register access
 - Fixed 32-bit data width
 - Optional asynchronous operation mode
- Independent AXI4 Master interface for primary CDMA datapath
 - Parameterizable width of 32, 64, 128, and 256 bits
- Independent AXI4 Master interface for optional Scatter/Gather function
 - Fixed 32-bit data width
- Optional Data Re-Alignment Engine for primary CDMA datapath
 - Available with 32 and 64-bit datapath widths
- Provides Simple DMA only mode and an optional hybrid mode supporting both Simple DMA and Scatter Gather automation
- Optional Store and Forward operation mode with internal Data FIFO (First In First Out)
- Parameterized Read and Write Address Pipeline depths

LogiCORE IP Facts Table			
Core Specifics			
Supported Device Family ⁽¹⁾	Virtex-7, Kintex-7™ Virtex-6, Spartan-6		
Supported User Interfaces	AXI4, AXI4-Lite		
Resources			
	LUTs	Slices	Block RAMs
See Table 22 and Table 23 .			
Provided with Core			
Documentation	Product Specification		
Design Files	VHDL		
Example Design	Not Provided		
Test Bench	Not Provided		
Constraints File	Not Provided		
Simulation Model	Not Provided		
Tested Design Tools			
Design Entry Tools	EDK 13.2, XPS		
Simulation	Mentor Graphics ModelSim ⁽²⁾		
Synthesis Tools	XST		
Support			
Provided by Xilinx, Inc.			

1. For a complete list of supported derivative devices, see [IDS Embedded Edition Derivative Device Support](#).
2. For the supported version of the tool, see the [ISE Design Suite 13: Release Notes Guide](#).

Applications

The AXI CDMA provides high performance Central Direct Memory Access function for Embedded Systems.

Functional Description

The AXI CDMA is designed to provide a centralized DMA function for use in an embedded processing system employing the AXI4 system interfaces. The core supports both a simple CDMA operation mode and an optional Scatter Gather automation mode. Figure 1 shows the functional composition of the AXI CDMA. The basic core design has an AXI4 Master interface for the main CDMA data transport function and an AXI4-Lite Slave interface for register accesses. An additional AXI4 Master interface is activated when the optional Scatter/Gather function is enabled.

The core's control and status registers are included in the Register Module. Access to these registers is provided through the AXI4-Lite Slave interface. The register module provides control and status for all CDMA operations.

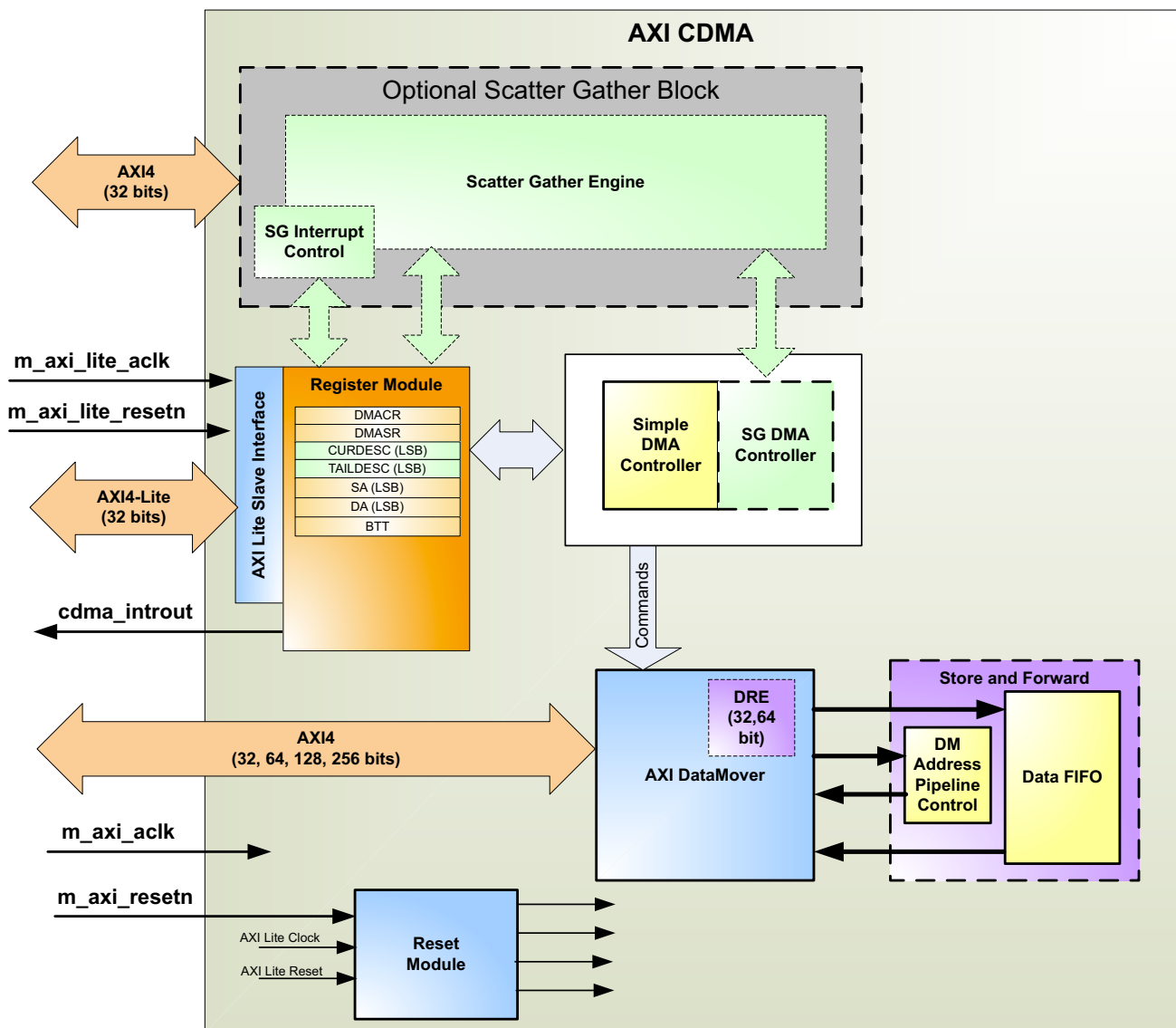

Figure 1: AXI CDMA Block Diagram

Primary high-speed CDMA data transport is provided by the AXI DataMover helper core. The AXI DataMover is used for high-throughput transfer of data from AXI4 to AXI4-Stream and from AXI4-Stream to AXI4. In the case of the AXI CDMA application, the DataMover's MM2S stream output can be directly looped back to the S2MM stream input or an optional Store and Forward function (with internal data FIFO) can link the MM2s Stream to the S2MM Stream. The DataMover provides CDMA operations with 4 kbyte address boundary protection, automatic burst partitioning, as well as providing the ability to queue multiple transfer requests. Furthermore, the AXI DataMover provides byte-level data realignment (for 32-bit and 64-bit data widths) allowing the CDMA to read from and write to any byte offset combination.

The AXI CDMA employs a Store and Forward (SF) function (optionally removable) that provides data buffering and management of the DataMover's address request pipelining. The SF design allows the DataMover to post Read transfer requests only when the Data FIFO has enough room to accept the entire AXI read transfer. In addition, the SF design only allows the DataMover to post write transfer requests when the associated transfer data is present in the Data FIFO. Thus, the SF design prevents the DataMover from over-commitment of the CDMA data transport that can lead to detrimental throttling of the Read and Write Data Channels by the AXI CDMA. The depth of the SF Data FIFO is automatically calculated to be the $(\max(C_READ_ADDR_PIPE_DEPTH, C_WRITE_ADDR_PIPE_DEPTH)+2)$ times $C_M_AXI_MAX_BURST_LEN$. The minimum depth is limited to 128.

The AXI CDMA can optionally include Scatter/Gather (SG) functionality for offloading CPU management tasks to hardware automation. The Scatter/Gather Engine fetches and updates CDMA control transfer descriptors from system memory through the AXI4 Scatter Gather Master interface. The SG engine provides internal descriptor queuing allowing descriptor prefetch and processing in parallel with ongoing CDMA data transfer operations.

Simple CDMA control sequencing is provided by the Simple Controller. It coordinates the DataMover command loading and status retrieval and update when a simple CDMA mode operation is commanded. The SG Controller is activated when the optional Scatter Gather function is enabled. The SG Controller coordinates the DataMover command loading and status retrieval just like the simple Controller but it also controls the Scatter Gather Engine operation.

All reset operations are coordinated by the Reset Module. It supports reset operations activated by the input `m_axi_aresetn` or `s_axi_lite_aresetn` (hardware resets) or by a User Application initiated by a write to the CDMA Control register reset bit (soft reset).

Clocking for the core is provided by two input clocks (`m_axi_aclk` and `s_axi_lite_aclk`). All CDMA data transport and Scatter Gather operations are synchronous to the rising edge of the `m_axi_aclk` clock. The AXI4-Lite register programming interface and the AXI CDMA interrupt output is synchronized to the `s_axi_lite_aclk` clock. These two clocks can be the same clock (synchronous) or different (asynchronous). If asynchronous, the frequency of the `s_axi_lite_aclk` must be less than or equal to the frequency the `m_axi_aclk` clock.

What's New for AXI CDMA v3_01_a

- Updated helper cores
 - `axi_datamover_v2_01_a`
 - `axi_sg_v2_02_a`
- Automatic assignment of the `C_AXI_LITE_IS_ASYNC` parameter via TCl script parsing of the signal names assigned to the clock input ports in the XPS MHS file.

Typical System Interconnect

The AXI CDMA core is designed to be connected in the user’s embedded system via the AXI4 Interconnect. A typical MicroBlaze processor configuration is shown in Figure 2. The system microprocessor has access to the AXI CDMA through the AXI4-Lite interface. For simple CDMA operations, the CDMA is programmed via the register interface to perform a single CDMA operation. The optional Scatter/Gather Engine fetches transfer descriptors from AXI_DDRx and automatically coordinates primary data transfers between the desired Source Address and Destination Address. The interrupt output of the AXI CDMA core is routed to the System’s Interrupt Controller for use in interrupting the processor when CDMA operations have completed (in either simple or SG assisted modes).

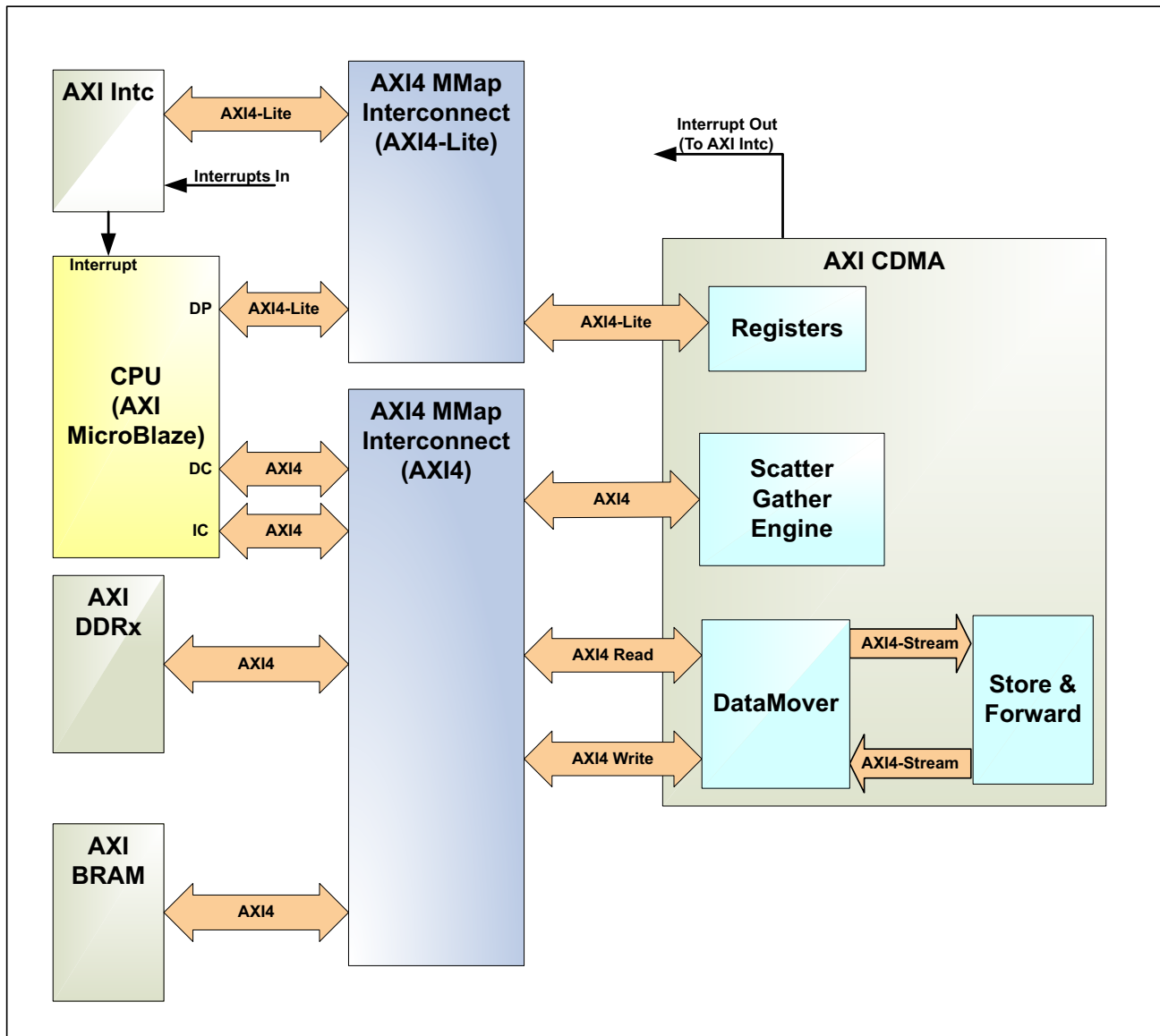

Figure 2: Typical MicroBlaze Processor System Configuration Using AXI CDMA

I/O Signals

The AXI CDMA signals are described in [Table 1](#).

Table 1: AXI CDMA I/O Signal Description

Signal Name	Interface	Signal Type	Init Status	Description
System Signals				
m_axi_aclk	Clock	I		AXI CDMA synchronization Clock.
m_axi_aresetn	Reset	I		AXI CDMA Reset. When asserted low, the AXI CDMA core is put into hard reset. This signal must be synchronous to m_axi_aclk. Assertion requirements are specified in Table 19, page 41 .
cdma_introut	Interrupt	O	0	Interrupt output for the AXI CDMA core
AXI4-Lite Slave Interface Signals				
s_axi_lite_aclk	S_AXI_LITE	I		Synchronization Clock for the AXI4-Lite interface. This clock might be the same as m_axi_aclk (synchronous mode) or different (asynchronous mode). Note: If it is asynchronous, the frequency of this clock must be less than or equal to the frequency of the m_axi_aclk.
s_axi_lite_aresetn	S_AXI_LITE	I		Active low AXI4-Lite Reset. When asserted low, the AXI4-Lite Register interface and the entire CDMA core logic is put into hard reset. This signal must be synchronous to s_axi_lite_aclk. Assertion requirements are specified in Table 19, page 41 .
s_axi_lite_awvalid	S_AXI_LITE	I		AXI4-Lite Write Address Channel Write Address Valid. <ul style="list-style-type: none"> 1 = Write address is valid. 0 = Write address is not valid.
s_axi_lite_awready	S_AXI_LITE	O	0	AXI4-Lite Write Address Channel Write Address Ready. Indicates CDMA ready to accept the write address. <ul style="list-style-type: none"> 1 = Ready to accept address. 0 = Not ready to accept address.
s_axi_lite_awaddr(31:0)	S_AXI_LITE	I		AXI4-Lite Write Address Bus.
s_axi_lite_wvalid	S_AXI_LITE	I		AXI4-Lite Write Data Channel Write Data Valid. <ul style="list-style-type: none"> 1 = Write data is valid. 0 = Write data is not valid.
s_axi_lite_wready	S_AXI_LITE	O	0	AXI4-Lite Write Data Channel Write Data Ready. Indicates CDMA ready to accept the write data. <ul style="list-style-type: none"> 1 = Ready to accept data. 0 = Not ready to accept data.
s_axi_lite_wdata(31:0)	S_AXI_LITE	I		AXI4-Lite Write Data Bus.
s_axi_lite_bresp(1:0)	S_AXI_LITE	O	zeros	AXI4-Lite Write Response Channel. Indicates results of the write transfer. The AXI CDMA Lite interface always responds with OKAY. <ul style="list-style-type: none"> 00b = OKAY - Normal access has been successful. 01b = EXOKAY - Not supported. 10b = SLVERR - Not supported. 11b = DECERR - Not supported.

Table 1: AXI CDMA I/O Signal Description (Cont'd)

Signal Name	Interface	Signal Type	Init Status	Description
s_axi_lite_bvalid	S_AXI_LITE	O	0	AXI4-Lite Write Response Channel Response Valid. Indicates response is valid. <ul style="list-style-type: none"> 1 = Response is valid. 0 = Response is not valid.
s_axi_lite_bready	S_AXI_LITE	I		AXI4-Lite Write Response Channel Ready. Indicates target is ready to receive response. <ul style="list-style-type: none"> 1 = Ready to receive response. 0 = Not ready to receive response.
s_axi_lite_arvalid	S_AXI_LITE	I		AXI4-Lite Read Address Channel Read Address Valid. <ul style="list-style-type: none"> 1 = Read address is valid. 0 = Read address is not valid.
s_axi_lite_arready	S_AXI_LITE	O	0	AXI4-Lite Read Address Channel Read Address Ready. Indicates CDMA ready to accept the read address. <ul style="list-style-type: none"> 1 = Ready to accept address. 0 = Not ready to accept address.
s_axi_lite_araddr(31:0)	S_AXI_LITE	I		AXI4-Lite Read Address Bus.
s_axi_lite_rvalid	S_AXI_LITE	O	0	AXI4-Lite Read Data Channel Read Data Valid. <ul style="list-style-type: none"> 1 = Read data is valid 0 = Read data is not valid
s_axi_lite_rready	S_AXI_LITE	I		AXI4-Lite Read Data Channel Read Data Ready. Indicates target ready to accept the read data. <ul style="list-style-type: none"> 1 = Ready to accept data. 0 = Not ready to accept data.
s_axi_lite_rdata(31:0)	S_AXI_LITE	O	zeros	AXI4-Lite Read Data Bus.
s_axi_lite_rresp(1:0)	S_AXI_LITE	O	zeros	AXI4-Lite Read Response Channel Response. Indicates results of the read transfer. The AXI CDMA Lite interface always responds with OKAY. <ul style="list-style-type: none"> 00b = OKAY - Normal access has been successful. 01b = EXOKAY - Not supported. 10b = SLVERR - Not supported. 11b = DECERR - Not supported.
CDMA Data AXI4 Read Master Interface Signals				
m_axi_araddr (C_M_AXI_ADDR_WIDTH-1: 0)	M_AXI	O	zeros	Read Address Channel Address Bus.
m_axi_arlen(7:0)	M_AXI	O	zeros	Read Address Channel Burst Length. In data beats - 1.
m_axi_arsize(2:0)	M_AXI	O	zeros	Read Address Channel Burst Size. Indicates with of burst transfer. <ul style="list-style-type: none"> 000b = Not Supported by AXI CDMA. 001b =Not Supported by AXI CDMA. 010b = 4 bytes (32-bit wide burst). 011b = 8 bytes (64-bit wide burst). 100b = 16 bytes (128-bit wide burst). 101b = 32 bytes (256-bit wide burst). 110b = Not Supported by AXI CDMA. 111b = Not Supported by AXI CDMA.

Table 1: AXI CDMA I/O Signal Description (Cont'd)

Signal Name	Interface	Signal Type	Init Status	Description
m_axi_arburst(1:0)	M_AXI	O	zeros	Read Address Channel Burst Type. Indicates type burst. <ul style="list-style-type: none"> • 00b = FIXED - Not supported. • 01b = INCR - Incrementing address. • 10b = WRAP - Not supported. • 11b = Reserved.
m_axi_arprot(2:0)	M_AXI	O	000b	Read Address Channel Protection. Always driven with a constant output of 000b.
m_axi_arcache(3:0)	M_AXI	O	0011b	Read Address Channel Cache. This is always driven with a constant output of 0011b.
m_axi_arvalid	M_AXI	O	0	Read Address Channel Read Address Valid. Indicates when the Read Address Channel qualifiers are valid. <ul style="list-style-type: none"> • 1 = Read address is valid. • 0 = Read address is not valid.
m_axi_arready	M_AXI	I		Read Address Channel Read Address Ready. Indicates target is ready to accept the read address. <ul style="list-style-type: none"> • 1 = Target read to accept address. • 0 = Target not ready to accept address.
m_axi_rdata (C_M_AXI_DATA_ WIDTH-1: 0)	M_AXI	I		Read Data Channel Read Data.
m_axi_rresp(1:0)	M_AXI	I		Read Data Channel Response. Indicates results of the read transfer. <ul style="list-style-type: none"> • 00b = OKAY - Normal access has been successful. • 01b = EXOKAY - Not supported. • 10b = SLVERR - Slave returned error on transfer. • 11b = DECERR - Decode error, transfer targeted unmapped address.
m_axi_rlast	M_AXI	I		Read Data Channel Last. Indicates the last data beat of a burst transfer. <ul style="list-style-type: none"> • 1 = Last data beat. • 0 = Not last data beat.
m_axi_rvalid	M_AXI	I		Read Data Channel Data Valid. Indicates m_axi_rdata is valid. <ul style="list-style-type: none"> • 1 = Valid read data. • 0 = Not valid read data.
m_axi_rready	M_AXI	O	0	Read Data Channel Ready. Indicates the read channel is ready to accept read data. <ul style="list-style-type: none"> • 1 = Ready. • 0 = Not ready.

Table 1: AXI CDMA I/O Signal Description (Cont'd)

Signal Name	Interface	Signal Type	Init Status	Description
CDMA Data AXI4 Write Master Interface Signals				
m_axi_awaddr (C_M_AXI_ADDR_WIDTH-1: 0)	M_AXI	O	zeros	Write Address Channel Address Bus.
m_axi_awlen(7: 0)	M_AXI	O	zeros	Write Address Channel Burst Length. In data beats - 1.
m_axi_awsz(2: 0)	M_AXI	O	zeros	Write Address Channel Burst Size. Indicates with of burst transfer. <ul style="list-style-type: none"> • 000b = Not Supported by AXI CDMA. • 001b = Not Supported by AXI CDMA. • 010b = 4 bytes (32 bit wide burst). • 011b = 8 bytes (64 bit wide burst). • 100b = 16 bytes (128 bit wide burst). • 101b = 32 bytes (256 bit wide burst). • 110b = Not Supported by AXI CDMA. • 111b = Not Supported by AXI CDMA.
m_axi_awburst(1:0)	M_AXI	O	zeros	Write Address Channel Burst Type. Indicates type burst. <ul style="list-style-type: none"> • 00b = FIXED - Not supported. • 01b = INCR - Incrementing address. • 10b = WRAP - Not supported. • 11b = Reserved.
m_axi_awprot(2:0)	M_AXI	O	000b	Write Address Channel Protection. This is always driven with a constant output of 000b.
m_axi_awcache(3:0)	M_AXI	O	0011b	Write Address Channel Cache. This is always driven with a constant output of 0011b.
m_axi_awvalid	M_AXI	O	0	Write Address Channel Write Address Valid. Indicates when the Write Address Channel qualifiers are valid. <ul style="list-style-type: none"> • 1 = Write Address is valid. • 0 = Write Address is not valid.
m_axi_awready	M_AXI	I		Write Address Channel Write Address Ready. Indicates target is ready to accept the write address. <ul style="list-style-type: none"> • 1 = Target read to accept address. • 0 = Target not ready to accept address.
m_axi_wdata (C_M_AXI_DATA_WIDTH-1: 0)	M_AXI	O	zeros	Write Data Channel Write Data Bus.
m_axi_wstrb (C_M_AXI_DATA_WIDTH/8 - 1: 0)	M_AXI	O	zeros	Write Data Channel Write Strobe Bus. Indicates which bytes are valid in the write data bus. This value is passed from the stream side strobe bus.
m_axi_wlast	M_AXI	O	0	Write Data Channel Last. Indicates the last data beat of a burst transfer. <ul style="list-style-type: none"> • 1 = Last data beat. • 0 = Not last data beat.
m_axi_wvalid	M_AXI	O	0	Write Data Channel Data Valid. Indicates m_axi_wdata is valid. <ul style="list-style-type: none"> • 1 = Valid write data. • 0 = Not valid write data.

Table 1: AXI CDMA I/O Signal Description (Cont'd)

Signal Name	Interface	Signal Type	Init Status	Description
m_axi_wready	M_AXI	I		Write Data Channel Ready. Indicates the write channel target is ready to accept write data. <ul style="list-style-type: none"> 1 = Target is ready 0 = Target is not ready
m_axi_bresp(1:0)	M_AXI	I		Write Response Channel Response. Indicates results of the write transfer. <ul style="list-style-type: none"> 00b = OKAY - Normal access has been successful. 01b = EXOKAY - Not supported. 10b = SLVERR - Slave returned error on transfer. 11b = DECERR - Decode error, transfer targeted unmapped address.
m_axi_bvalid	M_AXI	I		Write Response Channel Response Valid. Indicates response, m_axi_bresp, is valid. <ul style="list-style-type: none"> 1 = Response is valid. 0 = Response is not valid.
m_axi_bready	M_AXI	O	0	Write Response Channel Ready. Indicates the write channel is ready to receive the AXI write response. <ul style="list-style-type: none"> 1 = Ready to receive response. 0 = Not ready to receive response.
Scatter Gather AXI4 Read Master Interface Signals				
m_axi_sg_araddr (C_M_AXI_SG_ADDR_WIDTH-1: 0)	M_AXI_SG	O	zeros	Scatter Gather Read Address Channel Address Bus.
m_axi_sg_arlen(7: 0)	M_AXI_SG	O	zeros	Scatter Gather Read Address Channel Burst Length. Length in data beats - 1.
m_axi_sg_arsize(2: 0)	M_AXI_SG	O	zeros	Scatter Gather Read Address Channel Burst Size. Indicates with of burst transfer. <ul style="list-style-type: none"> 000b = Not Supported by AXI CDMA SG Engine. 001b = Not Supported by AXI CDMA SG Engine. 010b = 4 bytes (32 bit wide burst). 011b = Not Supported by AXI CDMA SG Engine. 100b = Not Supported by AXI CDMA SG Engine. 101b = Not Supported by AXI CDMA SG Engine. 110b = Not Supported by AXI CDMA SG Engine. 111b = Not Supported by AXI CDMA SG Engine.
m_axi_sg_arburst(1:0)	M_AXI_SG	O	zeros	Scatter Gather Read Address Channel Burst Type. Indicates type burst. <ul style="list-style-type: none"> 00b = FIXED - Not supported. 01b = INCR - Incrementing address. 10b = WRAP - Not supported. 11b = Reserved.
m_axi_sg_arprot(2:0)	M_AXI_SG	O	000b	Scatter Gather Read Address Channel Protection. This is always driven with a constant output of 000b.
m_axi_sg_arcache(3:0)	M_AXI_SG	O	0011b	Scatter Gather Read Address Channel Cache. This is always driven with a constant output of 0011b.

Table 1: AXI CDMA I/O Signal Description (Cont'd)

Signal Name	Interface	Signal Type	Init Status	Description
m_axi_sg_arvalid	M_AXI_SG	O	0	Scatter Gather Read Address Channel Read Address Valid. Indicates if m_axi_sg_araddr is valid. <ul style="list-style-type: none"> 1 = Read Address is valid. 0 = Read Address is not valid.
m_axi_sg_arready	M_AXI_SG	I		Scatter Gather Read Address Channel Read Address Ready. Indicates target is ready to accept the read address. <ul style="list-style-type: none"> 1 = Target read to accept address. 0 = Target not ready to accept address.
m_axi_sg_rdata (C_M_AXI_SG_DATA_WIDTH-1: 0)	M_AXI_SG	I		Scatter Gather Read Data Channel Read Data.
m_axi_sg_rresp(1:0)	M_AXI_SG	I		Scatter Gather Read Data Channel Response. Indicates results of the read transfer. <ul style="list-style-type: none"> 00b = OKAY - Normal access has been successful. 01b = EXOKAY - Not supported. 10b = SLVERR - Slave returned error on transfer. 11b = DECERR - Decode error, transfer targeted unmapped address.
m_axi_sg_rlast	M_AXI_SG	I		Scatter Gather Read Data Channel Last. Indicates the last data beat of a burst transfer. <ul style="list-style-type: none"> 1 = Last data beat. 0 = Not last data beat.
m_axi_sg_rdata	M_AXI_SG	I		Scatter Gather Read Data Channel Data Valid. Indicates m_sg_aximry_rdata is valid. <ul style="list-style-type: none"> 1 = Valid read data. 0 = Not valid read data.
m_axi_sg_rready	M_AXI_SG	O	0	Scatter Gather Read Data Channel Ready. Indicates the read channel is ready to accept read data. <ul style="list-style-type: none"> 1 = Is ready. 0 = Is not ready.
Scatter Gather AXI4 Write Master Interface Signals				
m_axi_sg_awaddr (C_M_AXI_SG_ADDR_WIDTH-1: 0)	M_AXI_SG	O	zeros	Scatter Gather Write Address Channel Address Bus.
m_axi_sg_awlen(7: 0)	M_AXI_SG	O	zeros	Scatter Gather Write Address Channel Burst Length. Length in data beats - 1.
m_axi_sg_awsz(2: 0)	M_AXI_SG	O	zeros	Scatter Gather Write Address Channel Burst Size. Indicates with of burst transfer. <ul style="list-style-type: none"> 000b = Not Supported by AXI CDMA SG Engine. 001b = Not Supported by AXI CDMA SG Engine. 010b = 4 bytes (32 bit wide burst). 011b = Not Supported by AXI CDMA SG Engine. 100b = Not Supported by AXI CDMA SG Engine. 101b = Not Supported by AXI CDMA SG Engine. 110b = Not Supported by AXI CDMA SG Engine. 111b = Not Supported by AXI CDMA SG Engine.

Table 1: AXI CDMA I/O Signal Description (Cont'd)

Signal Name	Interface	Signal Type	Init Status	Description
m_axi_sg_awburst(1:0)	M_AXI_SG	O	zeros	Scatter Gather Write Address Channel Burst Type. Indicates type burst. <ul style="list-style-type: none"> • 00b = FIXED - Not supported. • 01b = INCR - Incrementing address. • 10b = WRAP - Not supported. • 11b = Reserved.
m_axi_sg_awprot(2:0)	M_AXI_SG	O	000b	Scatter Gather Write Address Channel Protection. This is always driven with a constant output of 000b.
m_axi_sg_awcache(3:0)	M_AXI_SG	O	0011b	Scatter Gather Write Address Channel Cache. This is always driven with a constant output of 0011b.
m_axi_sg_awvalid	M_AXI_SG	O	0	Scatter Gather Write Address Channel Write Address Valid. Indicates if m_axi_sg_awaddr is valid. <ul style="list-style-type: none"> • 1 = Write Address is valid. • 0 = Write Address is not valid.
m_axi_sg_awready	M_AXI_SG	I		Scatter Gather Write Address Channel Write Address Ready. Indicates target is ready to accept the write address. <ul style="list-style-type: none"> • 1 = Target ready to accept address. • 0 = Target not ready to accept address.
m_axi_sg_wdata (C_M_AXI_SG_DATA_WIDTH-1 : 0)	M_AXI_SG	O	zeros	Scatter Gather Write Data Channel Write Data Bus.
m_axi_sg_wstrb (C_M_AXI_SG_DATA_WIDTH/8 - 1 : 0)	M_AXI_SG	O	1111b	Scatter Gather Write Data Channel Write Strobe Bus. All strobe bytes asserted for SG write address channel transfer requests.
m_axi_sg_wlast	M_AXI_SG	O	0	Scatter Gather Write Data Channel Last. Indicates the last data beat of a burst transfer. <ul style="list-style-type: none"> • 1 = Last data beat. • 0 = Not last data beat.
m_axi_sg_wvalid	M_AXI_SG	O	0	Scatter Gather Write Data Channel Data Valid. Indicates the Write Data Channel has a valid data beat on the bus. <ul style="list-style-type: none"> • 1 = Valid write data. • 0 = Not valid write data.
m_axi_sg_wready	M_AXI_SG	I		Scatter Gather Write Data Channel Ready. Indicates the SG Write Data Channel target slave is ready to accept write data. <ul style="list-style-type: none"> • 1 = Target slave is ready. • 0 = Target slave is not ready.
m_axi_sg_bresp(1:0)	M_AXI_SG	I		Scatter Gather Write Response Channel Response. Indicates results of the write transfer. <ul style="list-style-type: none"> • 00b = OKAY - Normal access has been successful. • 01b = EXOKAY - Not supported. • 10b = SLVERR - Slave returned error on transfer. • 11b = DECERR - Decode error, transfer targeted unmapped address.

Table 1: AXI CDMA I/O Signal Description (Cont'd)

Signal Name	Interface	Signal Type	Init Status	Description
m_axi_sg_bvalid	M_AXI_SG	I		Scatter Gather Write Response Channel Response Valid. Indicates response, m_axi_sg_bresp, is valid. <ul style="list-style-type: none"> • 1 = Response is valid. • 0 = Response is not valid.
m_axi_sg_bready	M_AXI_SG	O	0	Scatter Gather Write Response Channel Ready. Indicates source is ready to receive response. <ul style="list-style-type: none"> • 1 = Ready to receive response. • 0 = Not ready to receive response.

Design Parameters

The AXI CDMA Design Parameters are listed and described in [Table 2](#).

Table 2: AXI CDMA Design Parameter Description

Parameter Name	Allowable Values	Default Values	VHDL Type	Feature/Description
AXI CDMA General Parameters				
C_FAMILY	virtex6, spartan6	virtex6	String	Specifies the target FPGA family
AXI CDMA AXI4-Lite Parameters				
C_S_AXI_LITE_ADDR_WIDTH	32	32	integer	Address width (in bits) of AXI4-Lite Interface. This is currently fixed at 32 bits.
C_S_AXI_LITE_DATA_WIDTH	32	32	integer	Data width (in bits) of AXI4-Lite Interface. This is currently fixed at 32 bits.
C_AXI_LITE_IS_ASYNC	0,1	0	integer	Specifies if the s_axi_lite_aclk is different than the m_axi_aclk <ul style="list-style-type: none"> • 0 = s_axi_lite_aclk is the same as m_axi_aclk • 1 = s_axi_lite_aclk is different than the m_axi_aclk
AXI CDMA Data AXI4 Master Parameters				
C_M_AXI_ADDR_WIDTH	32	32	integer	Address width of the AXI4 master interface for the Data transfer path.
C_M_AXI_DATA_WIDTH	32, 64, 128, 256	32	integer	Data width of the AXI4 master interface for the Data transfer path.
C_M_AXI_MAX_BURST_LEN	16, 32, 64, 128, 256	16	integer	Specifies the maximum burst length to be requested by the Data AXI4 master for both read and writes.
C_INCLUDE_DRE	0,1	0	integer	Specifies the inclusion or omission of the Data Realignment Engine (DRE) in the DataMover (can only be included for 32-bit and 64-bit data widths). <ul style="list-style-type: none"> • 0 = Exclude DRE • 1 = Include DRE

Table 2: AXI CDMA Design Parameter Description (Cont'd)

Parameter Name	Allowable Values	Default Values	VHDL Type	Feature/Description
C_USE_DATAMOVER_LITE	0,1	0	integer	Specifies the use of a reduced resource version of the DataMover (can only be used for 32-bit and 64-bit data widths, no DRE, and burst lengths limited to 16, 32, and 64). <i>This parameter is ignored if Scatter Gather is enabled (C_INCLUDE_SG = 1).</i> <ul style="list-style-type: none"> 0 = Normal DataMover (full version) 1 = Reduced resource DataMover
C_READ_ADDR_PIPE_DEPTH	1-30	4	integer	This parameter specifies the depth of the DataMover read address pipelining queues for the Main data transport channels. The effective address pipelining on the AXI4 Read Address Channel is the value assigned plus 2. If the value assigned is 1, the effective address pipelining on the AXI4 Read Address Channel is the value assigned plus 1.
C_WRITE_ADDR_PIPE_DEPTH	1-30	4	integer	This parameter specifies the depth of the DataMover write address pipelining queues for the Main data transport channels. The effective address pipelining on the AXI4 Write Address Channel is the value assigned plus 2. However, if the value assigned is 1, the effective address pipelining on the AXI4 Read Address Channel is 2.
Store and Forward Parameters				
C_INCLUDE_SF	0,1	1	integer	Specifies the inclusion or omission of the Store and Forward feature <ul style="list-style-type: none"> 0 = Exclude Store and Forward 1 = Include Store and Forward
Scatter Gather Related Parameters				
C_INCLUDE_SG	0,1	0	integer	Specifies the inclusion or omission of the Scatter Gather feature <ul style="list-style-type: none"> 0 = Exclude Scatter Gather 1 = Include Scatter Gather
C_M_AXI_SG_ADDR_WIDTH	32	32	integer	Address width (in bits) of AXI Scatter Gather AXI4 Master interface
C_M_AXI_SG_DATA_WIDTH	32	32	integer	Data width (in bits) of AXI Scatter Gather AXI4 Master interface
C_DLYTMR_RESOLUTION	1 - 1000000	125	integer	Specifies the resolution of one tick of the SG interrupt delay timer in m_axi_aclk cycles

Allowable Parameter Combinations

Table 3: Allowable Parameter Combination

Parameter Name	Affects Parameter	Relationship Description
C_USE_DATAMOVER_LITE	C_INCLUDE_DRE	Affected Parameter is ignored when C_USE_DATAMOVER_LITE = 1
C_USE_DATAMOVER_LITE	C_M_AXI_MAX_BURST_LEN	Affected Parameter can only be assigned a value of 16, 32, or 64 when C_USE_DATAMOVER_LITE = 1
C_USE_DATAMOVER_LITE	C_M_AXI_DATA_WIDTH	Affected Parameter can only be assigned a value of 32 or 64 when C_USE_DATAMOVER_LITE = 1
C_INCLUDE_DRE	C_M_AXI_DATA_WIDTH	Affected Parameter can only be assigned a value of 32 or 64 when C_INCLUDE_DRE = 1
C_INCLUDE_SG	C_USE_DATAMOVER_LITE	Affected Parameter is ignored when C_INCLUDE_SG = 1
C_INCLUDE_SG	C_DLYTMR_RESOLUTION	Affected Parameter is ignored when C_INCLUDE_SG = 0

Parameter - I/O Signal Dependencies

Table 4: Parameter - I/O Signal Dependencies

Parameter Name	Affects Signal	Depends on Parameter	Relationship Description
C_M_AXI_LITE_DATA_WIDTH	m_axi_lite_wdata m_axi_lite_wstrb m_axi_lite_rdata		The setting of the parameter sets the vector width of the port.
C_M_AXI_LITE_ADDR_WIDTH	m_axi_lite_awaddr m_axi_lite_araddr		The setting of the parameter sets the vector width of the port.
C_M_AXI_SG_DATA_WIDTH	m_axi_sg_wdata m_axi_sg_wstrb m_axi_sg_rdata		The setting of the parameter sets the vector width of the port.
C_M_AXI_SG_ADDR_WIDTH	m_axi_sg_awaddr m_axi_sg_araddr		The setting of the parameter sets the vector width of the port.

Table 4: Parameter - I/O Signal Dependencies (Cont'd)

Parameter Name	Affects Signal	Depends on Parameter	Relationship Description
C_INCLUDE_SG	m_axi_sg_awaddr m_axi_sg_awlen m_axi_sg_awsz m_axi_sg_awburst m_axi_sg_awprot m_axi_sg_awcache m_axi_sg_awvalid m_axi_sg_awready m_axi_sg_wdata m_axi_sg_wstrb m_axi_sg_wlast m_axi_sg_wvalid m_axi_sg_wready m_axi_sg_bresp m_axi_sg_bvalid m_axi_sg_bready m_axi_sg_araddr m_axi_sg_arlen m_axi_sg_arsz m_axi_sg_arburst m_axi_sg_arprot m_axi_sg_arcache m_axi_sg_arvalid m_axi_sg_arready m_axi_sg_rdata m_axi_sg_rresp m_axi_sg_rlast m_axi_sg_rvalid m_axi_sg_rready		If the parameter is assigned a value of zero, the SG Interface output ports are tied to 0, and the SG Interface input ports are left open.
C_M_AXI_ADDR_WIDTH	m_axi_araddr m_axi_awaddr		The setting of the parameter sets the vector width of the port.
C_M_AXI_DATA_WIDTH	m_axi_rdata m_axi_wdata m_axi_wstrb		The setting of the parameter sets the vector width of the port.
C_USE_DATAMOVER_LITE	m_axi_rdata m_axi_wdata m_axi_wstrb		The setting of the affecting parameter to 1 limits the vector width of the effected ports. m_axi_rdata = 32 or 64 m_axi_wdata = 32 or 64 m_axi_wstrb = 4 or 8

Parameter Descriptions

C_FAMILY

- **Type:** string
- **Allowed Values:** Virtex®-6 and Spartan®-6 devices and later
- **Definition:** Indicates the target FPGA device family for the design
- **Description:** This parameter is set by the EDK tools to a value reflecting the FPGA device family selected for the EDK project.

C_S_AXI_LITE_ADDR_WIDTH

- **Type:** Integer
- **Allowed Values:** 32 (default = 32)
- **Definition:** Address bus width of the AXI4-Lite interface
- **Description:** This integer parameter is used by the AXI4-Lite interface to size the read and write address channel related components. The EDK tool suite assigns this parameter a fixed value of 32.

C_S_AXI_LITE_DATA_WIDTH

- **Type:** Integer
- **Allowed Values:** 32 (default = 32)
- **Definition:** Data bus width of the AXI4-Lite interface
- **Description:** This integer parameter is used by the AXI4-Lite interface to size the read and write data channel related components within the Lite interface. The EDK tool suite assigns this parameter a fixed value of 32.

C_AXI_LITE_IS_ASYNC

- **Type:** Integer
- **Allowed Values:** 0,1 (default = 0)
- **Definition:** 0 = `s_axi_lite_aclk` is the same (synchronous) to `m_axi_aclk`, 1 = `s_axi_lite_aclk` is different (asynchronous) to `m_axi_aclk`
- **Description:** This integer parameter indicates to the AXI CDMA logic that the clock supplied to the `s_axi_lite_aclk` input is the same or different than that supplied to the `m_axi_aclk` input. If the `s_axi_lite_aclk` is different, it must have a frequency that is less than or equal to the frequency of the `m_axi_aclk`.

Note: The AXI CDMA v3_01_a incorporates a TCL script that automatically sets the appropriate value for this parameter based on a compare of the signal names attached to the `m_axi_aclk` and `s_axi_lite_aclk` inputs in the XPS MHS file.

C_INCLUDE_DRE

- **Type:** Integer
- **Allowed Values:** 0,1 (default = 1)
- **Definition:** 0 = Exclude Data Realignment Engine; 1 = Include Data Realignment Engine
- **Description:** Include or exclude the Data Realignment Engine. For use cases where all transfers are `C_M_AXI_DATA_WIDTH` aligned, this parameter can be set to 0 to exclude DRE, saving FPGA resources. Setting this parameter to 1 allows data realignment to the byte (8 bits) address resolution on the data transport AXI4 interface. DRE is only supported for `C_M_AXI_DATA_WIDTH = 32` and `C_M_AXI_DATA_WIDTH = 64`.
When DRE is included, CDMA data reads can start from any address byte offset (the transfer source address). DRE realigns the read data to match the starting offset of the programmed destination address.

Note: If DRE is disabled (`C_INCLUDE_DRE = 0`) or DRE does not support the specified data width (`C_M_AXI_DATA_WIDTH = 128` or `256`), the offset of the transfer source address must match the offset of the transfer destination address. Offset is defined as that portion of a system address that is used to designate a byte position within a single data beat width. For example, a 32-bit data bus has four addressable byte positions within a single data beat (0, 1, 2, and 3). The portion of the address that designates these positions is the offset. The number of address bits used for the offset varies with the transfer bus data width.

C_M_AXI_ADDR_WIDTH

- **Type:** Integer
- **Allowed Values:** 32 (default = 32)
- **Definition:** Address bus width of the data transport AXI4 master interface
- **Description:** This integer parameter is used to size the address bus for the data transport AXI4 master interface. The EDK tool suite assigns this parameter a fixed value of 32.

C_M_AXI_ADDR_WIDTH

- **Type:** Integer
- **Allowed Values:** 32 (default = 32)
- **Definition:** Address Channel width of the AXI CDMA AXI4 data transport interface
- **Description:** This integer parameter is used to size the AXI CDMA AXI4 data transport address channel related qualifiers. The EDK tool suite assigns this parameter a fixed value of 32.

C_M_AXI_DATA_WIDTH

- **Type:** Integer
- **Allowed Values:** 32, 64, 128, 256 (default = 32)
- **Definition:** Data Channel width of the AXI CDMA AXI4 data transport interface
- **Description:** This integer parameter is used to size the AXI CDMA AXI4 data transport Data Channel related qualifiers.

C_M_AXI_MAX_BURST_LEN

- **Type:** Integer
- **Allowed Values:** 16, 32, 64, 128, 256 (default = 16)
- **Definition:** Maximum burst length used (in data beats) by AXI CDMA for data transfers
- **Description:** This parameter limits the burst length requested by CDMA on the AXI4 data transport interface. A value of 256 is not allowed if the `C_M_AXI_DATA_WIDTH` parameter is assigned a value of 256. An AXI 4K address boundary crossing violation could occur otherwise.

C_USE_DATAMOVER_LITE

- **Type:** Integer
- **Allowed Values:** 0,1 (default = 0)
- **Definition:** 0 = Use Full DataMover; 1 = Use DataMover Lite
- **Description:** This parameter allows the DataMover used in the main CDMA data transport path to be implemented in a "lite" mode. DataMover Lite is useful for resource limited designs that requires a smaller resource utilization traded off for high performance data transfer. This parameter is ignored if Scatter Gather is enabled (`C_INCLUDE_SG = 1`).

C_READ_ADDR_PIPE_DEPTH

- **Type:** Integer
- **Allowed Values:** 1 to 30 (default = 4)
- **Definition:** Sets the Read Address Pipeline depth for the DataMover MM2S function
- **Description:** This parameter specifies the depth of the DataMover read address pipelining queues for the Main data transport channel. The effective address pipelining on the AXI4 Read Address Channel is the value assigned plus 2. If the value assigned is 1, the effective address pipelining on the AXI4 Read Address Channel is the value assigned plus 1.

C_WRITE_ADDR_PIPE_DEPTH

- **Type:** Integer
- **Allowed Values:** 1 to 30 (default = 4)
- **Definition:** Sets the Write Address Pipeline depth for the DataMover S2MM function
- **Description:** This parameter specifies the depth of the DataMover write address pipelining queues for the Main data transport channel. The effective address pipelining on the AXI4 Write Address Channel is the value assigned plus 2. If the value assigned is 1, the effective address pipelining will be 2.

C_INCLUDE_SF

- **Type:** Integer
- **Allowed Values:** 0,1 (default = 1)
- **Definition:** 0 = Exclude Store and Forward; 1 = Include Store and Forward
- **Description:** This parameter specifies the inclusion or omission of the Store and Forward function.

C_INCLUDE_SG

- **Type:** Integer
- **Allowed Values:** 0,1 (default = 0)
- **Definition:** 0 = Exclude Scatter Gather; 1 = Include Scatter Gather
- **Description:** Include or exclude the Scatter Gather support feature. When set to 0, only Simple Mode DMA operations are supported by AXI CDMA. When set to 1, both Simple and Scatter Gather assisted transfers are supported.

C_M_AXI_SG_ADDR_WIDTH

- **Type:** Integer
- **Allowed Values:** 32 (default = 32)
- **Definition:** Address bus width of attached AXI on the AXI Scatter Gather interface
- **Description:** This integer parameter is used to size the Read Address and Write Address Channels of the AXI4 Scatter Gather interface. The EDK tool suite assigns this parameter a fixed value of 32.

C_M_AXI_SG_DATA_WIDTH

- **Type:** Integer
- **Allowed Values:** 32 (default = 32)
- **Definition:** Data bus width of attached AXI on the AXI Scatter/Gather interface
- **Description:** This integer parameter is used to size the Read Data and Write Data Channels of the AXI4 Scatter Gather interface. The EDK tool suite assigns this parameter a fixed value of 32.

C_DLYTMR_RESOLUTION

- **Type:** Integer
- **Allowed Values:** 1 to 100,000 (default = 256)
- **Definition:** Interrupt Delay Timer Resolution in 'axi_aclk' cycles
- **Description:** This integer parameter is used to set the resolution of the Interrupt Delay Timer. The value assigned specifies the number of the input 'axi_aclk' clock cycles between each tick of the delay timer. The Delay Timer is only used during Scatter Gather operations. For additional information, see the section [SG Delay Interrupt](#).

Register Space

The AXI CDMA core register space is summarized in [Table 5](#). The AXI CDMA Registers are memory-mapped into non-cacheable memory space. The registers are 32 bits wide and the register memory space must be aligned on 128-byte (80h) boundaries.

Register Address Mapping

Table 5: AXI CDMA Register Summary

Address Space Offset ⁽¹⁾	Name	Description
00h	CDMACR	CDMA Control Register
04h	CDMASR	CDMA Status Register
08h	CURDESC_PNTR	Current Descriptor Pointer Register
0Ch	Reserved	N/A
10h	TAILDESC_PNTR	Tail Descriptor Pointer Register
14h	Reserved	N/A
18h	SA	Source Address Register
1Ch	Reserved	N/A
20h	DA	Destination Address Register
24h	Reserved	N/A
28h	BTT	Bytes to Transfer Register

1. Address Space Offset is relative to C_BASEADDR assignment. C_BASEADDR is defined in AXI CDMA MPD file and set by XPS.

Endianess

All registers are in Little Endian format, as shown in [Figure 3](#).

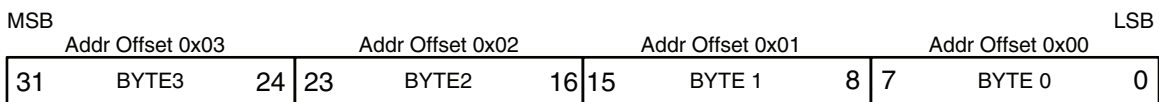

Figure 3: 32-bit Little Endian Example

Register Detail

CDMACR (CDMA Control Register - Offset 00h)

This register provides software application control of the AXI CDMA.

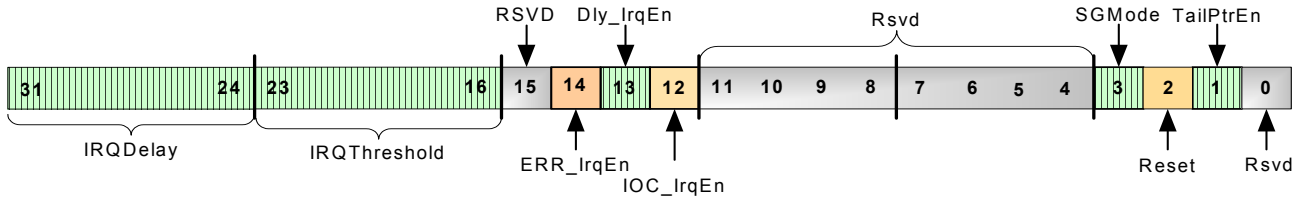

Figure 4: CDMACR Register

Table 6: CDMACR Register Details

Bits	Field Name	Default Value	Access Type	CDMA Mode Used	Description
31 to 24	IRQDelay	00h	R/W	SG	Interrupt Delay Time Out. This value is used for setting the interrupt delay time out value. The interrupt time out is a mechanism for causing the CDMA engine to generate an interrupt after the delay time period has expired. This is used for cases when the interrupt threshold is not met after a period of time, and the CPU desires an interrupt to be generated. Timer begins counting when the CDMA is IDLE (CDMACR.Idle = '1'). This generally occurs when the CDMA has completed all scheduled work defined by the transfer descriptor chain (reached the tail pointer) and has not satisfied the Interrupt Threshold count. Note: Setting this value to zero disables the delay timer interrupt.
23 to 16	IRQThreshold	01h	R/W	SG	Interrupt Threshold value. This field is used for setting the Scatter Gather interrupt coalescing threshold. When IOC interrupt events occur, an internal counter counts down from the Interrupt Threshold setting. When the count reaches zero, an interrupt out is generated by the CDMA engine. Note: The minimum setting for the threshold is 0x01. A write of 0x00 to this register has no effect. If the CDMA is built with SG disabled (Simple Mode Only), the default value of the port is zeros.
15	Reserved	0	RO	N/A	Writing to this bit has no effect and it is always read as zeros.
14	Err_IrqEn	0	R/W	Simple & SG	Interrupt on Error Interrupt Enable. When set to 1, it allows the CDMASR.Err_Irq to generate an interrupt out. <ul style="list-style-type: none"> 0 = Error Interrupt disabled 1 = Error Interrupt enabled
13	Dly_IrqEn	0	R/W	SG	Interrupt on Delay Timer Interrupt Enable. When set to 1, it allows CDMASR.Dly_Irq to generate an interrupt out. This is only used with Scatter Gather assisted transfers. <ul style="list-style-type: none"> 0 = Delay Interrupt disabled 1 = Delay Interrupt enabled
12	IOC_IrqEn	0	R/W	Simple & SG	Interrupt on Complete Interrupt Enable. When set to 1, it allows CDMASR.IOC_Irq to generate an interrupt out for completed DMA transfers. <ul style="list-style-type: none"> 0 = IOC Interrupt disabled 1 = IOC Interrupt enabled

Table 6: CDMACR Register Details (Cont'd)

Bits	Field Name	Default Value	Access Type	CDMA Mode Used	Description
11 to 4	Reserved	0	RO	N/A	Writing to these bits has no effect and they are always read as zeros.
3	SGMode	0	RW	Simple & SG	<p>This bit controls the transfer mode of the CDMA. Setting this bit to a 1 causes the AXI CDMA to operate in a Scatter Gather mode if the Scatter Gather engine is included (C_INCLUDE_SG = 1).</p> <ul style="list-style-type: none"> 0 = Simple DMA Mode 1 = Scatter Gather Mode (Only valid if C_INCLUDE_SG = 1) <p>Note: This bit must only be changed when the CDMA engine is IDLE (CDMASR.Idle = 1). Changing the state of this bit at any other time has undefined results.</p> <p>Note: This bit must be set to a 0 then back to 1 by the software application to force the CDMA SG engine to use a new value written to the CURDESC_PNTR register.</p> <p>Note: This bit must be set prior to setting the CDMACR.Dly_IrqEn bit. Otherwise, the CDMACR.Dly_IrqEn bit does not get set.</p>
2	Reset	0	RW	Simple & SG	<p>Soft reset control for the AXI CDMA core. Setting this bit to a 1 causes the AXI CDMA to be reset. Reset is accomplished gracefully. Committed AXI4 transfers are then completed. Other queued transfers are flushed. After completion of a soft reset, all registers and bits are in the Reset State.</p> <ul style="list-style-type: none"> 0 = Reset NOT in progress - Normal operation. 1 = Reset in progress.
1	TailPntrEn	1	RO	SG	<p>Indicates tail pointer mode is enabled to the SG Engine. This bit is fixed to 1 and always read as 1 when SG is included. If the CDMA is built with SG disabled (Simple Mode Only), the default value of the port is 0.</p>
0	Reserved	0	RO	N/A	Writing to these bits has no effect, and they are always read as zeros.

RO = Read Only. Writing has no effect.
R/W = Read / Write.

CDMASR (CDMA Status Register- Offset 04h)

This register provides status for the AXI CDMA.

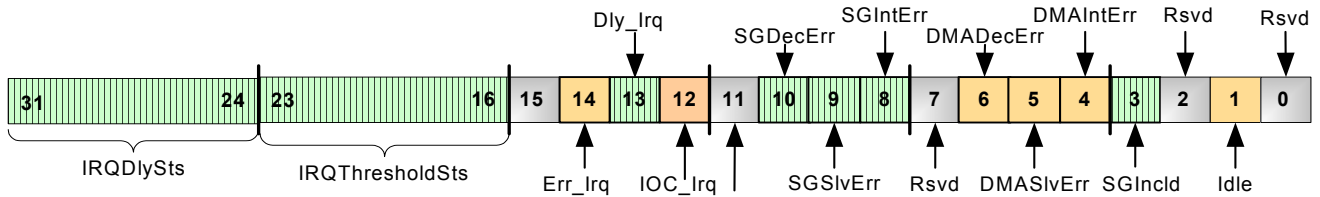

Figure 5: CDMASR Register

Table 7: CDMASR Register Details

Bits	Field Name	Default Value	Access Type	CDMA Mode Used	Description
31 to 24	IRQDelaySts	00h	RO	SG	Interrupt Delay Time Status. This field reflects the current interrupt delay timer value in the SG Engine.
23 to 16	IRQThresholdSts	01h	RO	SG	Interrupt Threshold Status. This field reflects the current interrupt threshold value in the SG Engine.
15	Reserved	0	RO	N/A	Always read as zero.
14	Err_Irq	0	R/WC	Simple & SG	Interrupt on Error. When set to 1, this bit indicates an interrupt event has been generated due to an error condition. If the corresponding enable bit is set (CDMACR.Err_IrqEn = 1), an interrupt out is generated from the AXI CDMA. 0 = No error Interrupt. 1 = Error interrupt active.
13	Dly_Irq	0	R/WC	SG	Interrupt on Delay. When set to 1, this bit indicates an interrupt event has been generated on a delay timer time out. If the corresponding enable bit is set (CDMACR.Dly_IrqEn = 1), an interrupt out is generated from the AXI CDMA. • 0 = No Delay Interrupt. • 1 = Delay Interrupt active. Note: This bit is cleared whenever CDMACR.SGMode is set to '0'.
12	IOC_Irq	0	R/WC	Simple & SG	Interrupt on Complete. When set to 1, this bit indicates an interrupt event has been generated on completion of a DMA transfer (either a Simple or SG). If the corresponding enable bit is set (CDMACR.IOC_IrqEn = 1), an interrupt out is generated from the AXI CDMA. • 0 = No IOC Interrupt. • 1 = IOC Interrupt active. Note: When operating in SG mode, the criteria specified by the interrupt threshold must also be met.
11	Reserved	0	RO	N/A	Writing to this bit has no effect and it is always read as zeros.

Table 7: CDMASR Register Details (Cont'd)

Bits	Field Name	Default Value	Access Type	CDMA Mode Used	Description
10	SGDecErr	0	RO	SG	<p>Scatter Gather Decode Error. This bit indicates that a AXI decode error has been received by the SG Engine during a AXI transfer (transfer descriptor read or write). This error occurs if the SG Engine issues an address that does not have a mapping assignment to a slave device. This error condition causes the AXI CDMA to gracefully halt. The CDMASR.Idle bit is set to 1 when the CDMA has completed shut down.</p> <ul style="list-style-type: none"> 0 = No SG Decode Errors. 1 = SG Decode Error detected. CDMA Engine halts. <p>Note: In SG Mode, the CURDESC_PNTR register is updated with the descriptor pointer value when this error is detected. If multiple errors are detected, the errors are logged in the CDMASR, but only one address is updated to the CURDESC_PNTR. A reset (soft or hard) must be issued to clear the error condition.</p>
9	SGSlvErr	0	RO	SG	<p>Scatter Gather Slave Error. This bit indicates that a AXI slave error response has been received by the SG Engine during a AXI transfer (transfer descriptor read or write). This error condition causes the AXI CDMA to gracefully halt. The CDMASR.Idle bit is set to 1 when the CDMA has completed shut down.</p> <ul style="list-style-type: none"> 0 = No SG Slave Errors. 1 = SG Slave Error detected. CDMA Engine halts. <p>Note: In SG Mode, the CURDESC_PNTR register is updated with the descriptor pointer value when this error is detected. If multiple errors are detected, the errors are logged in the CDMASR, but only one address is updated to the CURDESC_PNTR. A reset (soft or hard) must be issued to clear the error condition.</p>
8	SGIntErr	0	RO	SG	<p>Scatter Gather Internal Error. This bit indicates that a internal error has been encountered by the SG Engine. This error condition causes the AXI CDMA to gracefully halt. The CDMASR.Idle bit is set to 1 when the CDMA has completed shut down.</p> <ul style="list-style-type: none"> 0 = No SG Internal Errors. 1 = SG Internal Error detected. CDMA Engine halts. <p>Note: In SG Mode, the CURDESC_PNTR register is updated with the descriptor pointer value when this error is detected. If multiple errors are detected, the errors is logged in the CDMASR, but only one address is updated to the CURDESC_PNTR. A reset (soft or hard) must be issued to clear the error condition.</p>
7	Reserved	0	RO	N/A	Writing to this bit has no effect and it is always read as zeros.

Table 7: CDMASR Register Details (Cont'd)

Bits	Field Name	Default Value	Access Type	CDMA Mode Used	Description
6	DMADecErr	0	RO	Simple & SG	<p>DMA Decode Error. This bit indicates that an AXI decode error has been received by the AXI DataMover. This error occurs if the DataMover issues an address that does not have a mapping assignment to a slave device. This error condition causes the AXI CDMA to halt gracefully. The CDMASR.Idle bit is set to 1 when the CDMA has completed shut down.</p> <ul style="list-style-type: none"> 0 = No CDMA Decode Errors. 1 = CDMA Decode Error detected. CDMA Engine halts. <p>Note: In SG Mode, the CURDESC_PNTR register is updated with the descriptor pointer value when this error is detected. If multiple errors are detected, the errors are logged in the CDMASR, but only one address is updated to the CURDESC_PNTR. A reset (soft or hard) must be issued to clear the error condition.</p>
5	DMASlvErr	0	RO	Simple & SG	<p>DMA Slave Error. This bit indicates that a AXI slave error response has been received by the AXI DataMover during a AXI transfer (read or write). This error condition causes the AXI CDMA to gracefully halt. The CDMASR.Idle bit is set to 1 when the CDMA has completed shut down.</p> <ul style="list-style-type: none"> 0 = No CDMA Slave Errors. 1 = CDMA Slave Error detected. CDMA Engine halts. <p>Note: In SG Mode, the CURDESC_PNTR register is updated with the descriptor pointer value when this error is detected. If multiple errors are detected, the errors are logged in the CDMASR, but only one address is updated to the CURDESC_PNTR. A reset (soft or hard) must be issued to clear the error condition.</p>
4	DMAIntErr	0	RO	Simple & SG	<p>DMA Internal Error. This bit indicates that a internal error has been encountered by the DataMover on the data transport channel. This error can occur if a 0 value BTT (bytes to transfer) is fed to the AXI DataMover or DataMover has an internal processing error. A BTT of 0 only happens if the BTT register is written with zeros (in Simple DMA mode) or a BTT specified in the Control word of a fetched descriptor is set to 0 (SG Mode). This error condition causes the AXI CDMA to gracefully halt. The CDMASR.Idle bit is set to 1 when the CDMA has completed shut down.</p> <ul style="list-style-type: none"> 0 = No CDMA Internal Errors. 1 = CDMA Internal Error detected. CDMA Engine halts. <p>Note: In SG Mode, the CURDESC_PNTR register is updated with the descriptor pointer value when this error is detected. If multiple errors are detected, the errors is logged in the CDMASR, but only one address is updated to the CURDESC_PNTR. A reset (soft or hard) must be issued to clear the error condition.</p>

Table 7: CDMASR Register Details (Cont'd)

Bits	Field Name	Default Value	Access Type	CDMA Mode Used	Description
3	SGIncl	See Description	RO	Simple & SG	<p>SG Included. This bit indicates if the AXI CDMA has been implemented with Scatter Gather support included (C_SG_ENABLE = 1). This is used by application software (drivers) to determine if SG Mode can be utilized.</p> <ul style="list-style-type: none"> 0 = Scatter Gather not included. Only Simple DMA operations are supported. 1 = Scatter Gather is included. Both Simple DMA and Scatter Gather operations are supported.
2	Reserved	0	RO	N/A	Writing to these bits has no effect and they are always read as zeros.
1	Idle	0	RO	Simple & SG	<p>CDMA Idle. Indicates the state of AXI CDMA operations. When set and in Simple DMA mode, the bit indicates the programmed transfer has completed and the CDMA is waiting for a new transfer to be programmed. Writing to the BTT register in Simple DMA mode causes the CDMA to start (not Idle). When set and in SG mode, the bit indicates the SG Engine has reached the tail pointer for the associated channel and all queued descriptors have been processed. Writing to the tail pointer register automatically restarts CDMA SG operations.</p> <ul style="list-style-type: none"> 0 = Not Idle - Simple or SG DMA operations are in progress. 1 = Idle - Simple or SG operations completed or not started.
0	Reserved	0	RO	SG	Writing to these bits has no effect and they are always read as zeros.

RO = Read Only. Writing has no effect.

R/WC = Read / Write to Clear. A CPU write of 1 clears the associated bit to 0.

CURDESC_PNTR (CDMA Current Descriptor Pointer Register- Offset 08h)

This register provides the Current Descriptor Pointer for the AXI CDMA Scatter Gather Descriptor Management.

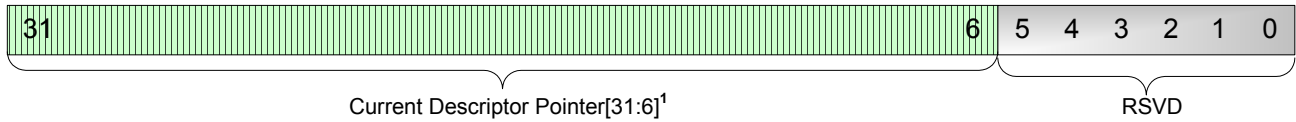

Figure 6: CURDESC_PNTR Register

Table 8: CURDESC_PNTR Register Details

Bits	Field Name	Default Value	Access Type	CDMA Mode Used	Description
31 to 6	Current Descriptor Pointer	zeros	R/W (RO)	SG	<p>Current Descriptor Pointer. This register field is written by the software application (in SG Mode) to set the starting address of the first transfer descriptor to execute for an SG operation. The address written corresponds to a 32-bit system address with the least significant 6 bits truncated. This register field must contain a valid descriptor address prior to the software application writing the CDMA TAILDESC_PNTR register value. Failure to do so results in an undefined operation by the CDMA.</p> <p>When the CDMA SG Engine is running (CDMASR.Idle=0), the CURDESC_PNTR register is updated by the SG Engine to reflect the starting address of the current descriptor being executed.</p> <p>On error detection, the CURDESC_PNTR register is updated to reflect the descriptor associated with the detected error.</p> <p>Note: The register should only be written by the SW application when the AXI CDMA is Idle (CDMASR.Idle=1). Descriptor addresses written to this field must be aligned to 64-byte boundaries (16 32-bit words). Examples are 0x00, 0x40, 0x80, etc. Any other alignment has undefined results.</p> <p>Note: This register is cleared when CDMACR.SGMode=0.</p>
5 to 0	Reserved	0	RO	N/A	Writing to these bits has no effect and they are always read as zeros.

RO = Read Only. Writing has no effect.

R/WC = Read / Write to Clear. A write of 1 clears the associated bit to 0.

TAILDESC_PNTR (CDMA Tail Descriptor Pointer Register- Offset 10h)

This register provides Tail Descriptor Pointer for the AXI CDMA Scatter Gather Descriptor Management.

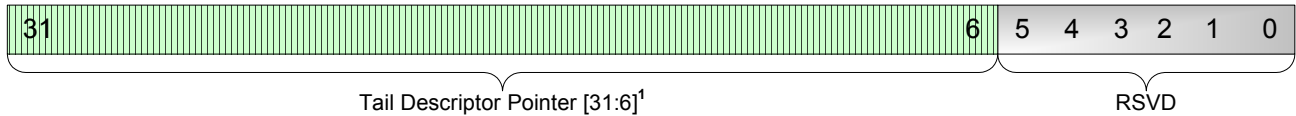

Figure 7: TAILDESC_PNTR Register

Table 9: TAILDESC_PNTR Register Details

Bits	Field Name	Default Value	Access Type	CDMA Mode Used	Description
31 to 6	Tail Descriptor Pointer	zeros	R/W (RO)	SG	<p>Tail Descriptor Pointer. This register field is written by the software application (in SG Mode) to set the current pause pointer for descriptor chain execution. The AXI CDMA SG Engine pauses descriptor fetching after completing operations on the descriptor whose current descriptor pointer matches the tail descriptor pointer.</p> <p>When the AXI CDMA is in SG Mode (CDMACR.SGMode = 1), a write by the software application to the TAILDESC_PNTR register causes the AXI CDMA SG Engine to start fetching descriptors starting from the CURDESC_PNTR register value. If the SG engine is paused at a tailpointer pause point, the SG engine restarts descriptor execution at the next sequential transfer descriptor. If the AXI CDMA is not idle (CDMASR.Idle = 0), writing to the TAILDESC_PNTR has no effect except to reposition the SG pause point.</p> <p>Note: The software application must not move the tail pointer to a location that has not been updated with valid transfer descriptors. The software application must process and reallocate all completed descriptors (Descriptor Status.Cmpl = 1), clear the completed bits and then move the tail pointer. The software application must move the pointer to the last descriptor address it has updated.</p> <p>Note: This register is cleared when CDMACR.SGMode=0.</p>
5 to 0	Reserved	0	RO	N/A	Writing to these bits has no effect and they are always read as zeros.

RO = Read Only. Writing has no effect.

R/WC = Read / Write to Clear - A CPU write of 1 clears the associated bit to 0.

SA (CDMA Source Address Register - Offset 18h)

This register provides the source address for Simple DMA transfers by AXI CDMA.



Figure 8: SA Register

Table 10: SA Register Details

Bits	Field Name	Default Value	Access Type	CDMA Mode Used	Description
31 to 0	SA	Zeros	R/W	Simple	<p>Source Address Register. This register is used by Simple DMA operations (CDMACR.SGMode = 0) as the starting read address for DMA data transfers. The address value written can be at any byte offset.</p> <p>Note: The software application should only write to this register when the AXI CDMA is Idle (CDMASR.Idle=1).</p>
<p>RO = Read Only. Writing has no effect. R/W = Read / Write.</p>					

DA (CDMA Destination Address Register- Offset 20h)

This register provides the Destination Address for Simple DMA transfers by AXI CDMA.

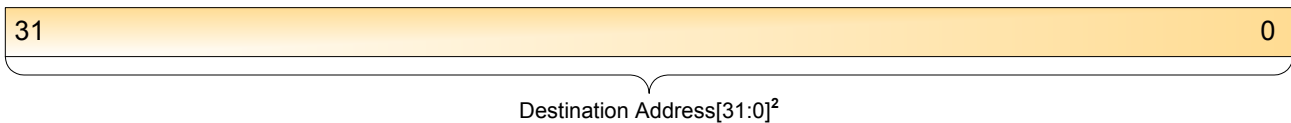

Figure 9: DA Register

Table 11: DA Register Details

Bits	Field Name	Default Value	Access Type	CDMA Mode Used	Description
0	DA	Zeros	RO	Simple	<p>Destination Address Register. This register is used by Simple DMA operations as the starting write address for DMA data transfers. The address value written has restrictions relative to the Source Address and DRE inclusion as follows.</p> <p>If DRE is not included in the AXI CDMA (C_INCLUDE_DRE = 0) or the DMA data width is 128 or 256 bits (C_M_AXI_DATA_WIDTH = 128 or 256), then the address offset of the Destination address must match that of the Source Address Register value. Offset is defined as that portion of a system address that is used to designate a byte position within a single data beat width. For example, a 32-bit data bus has four addressable byte positions within a single data beat (0, 1, 2, and 3). The portion of the address that designates these positions is the offset. The number of address bits used for the offset varies with the transfer bus data width.</p> <p>Note: The software application should only write to this register when the AXI CDMA is Idle (CDMASR.Idle=1).</p>
<p>RO = Read Only. Writing has no effect. R/WC = Read / Write to Clear. A CPU write of 1 clears the associated bit to 0.</p>					

BTT (CDMA Bytes to Transfer Register- Offset 28h)

This register provides the value for the bytes to transfer for Simple DMA transfers by the AXI CDMA.

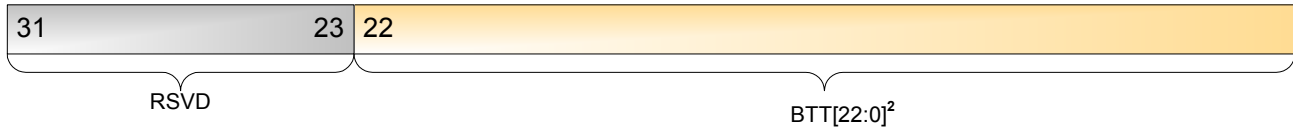

Figure 10: BTT Register

Table 12: BTT Register Details

Bits	Field Name	Default Value	Access Type	Description
31 to 23	Reserved	Zeros	RO	Writing to these bits has no effect, and they are always read as zeros.
22 to 0	BTT	zeros	R/W (RO)	<p>Bytes to Transfer. This register field is used for Simple DMA transfers and indicates the desired number of bytes to DMA from the Source Address to the Destination Address. A maximum of 8,388,607 bytes of data can be specified by this field for the associated transfer. Writing to the BTT Register also initiates the Simple DMA transfer.</p> <p>Note: A value of zero (0) is not allowed and causes a DMA internal error to be set by AXI CDMA. The software application should only write to this register when the AXI CDMA is Idle (CDMASR.Idle=1).</p>

RO = Read Only. Writing has no effect.
R/W = Read / Write.

DataMover Lite Mode Restrictions

The AXI DataMover that is internally used by the AXI CDMA can be optionally programmed to a reduced feature set to provide a reduced resource utilization footprint in the target FPGA (see the CDMA resource utilizations in Table 22 and Table 23). Using the DataMover Lite operation mode puts restrictions on the available CDMA features. Following is a list of feature restrictions (compared to the Full mode).

- The AXI CDMA data transport width is restricted to 32 and 64 bits.
 - C_M_AXI_DATA_WIDTH = 32 or 64 only
- The Max Burst Length is restricted to 16, 32, and 64 data beats.
 - C_M_AXI_MAX_BURST_LEN = 16, 32, or 64 only
- Maximum allowed bytes to transfer (BTT) value that is programmed per transfer request is limited to the specified maximum burst length times the specified CDMA data width divided by 8.
 - C_M_AXI_MAX_BURST_LEN * (C_M_AXI_DATA_WIDTH/8)
- The DRE function is not supported with Data Mover Lite.
 - C_INCLUDE_DRE must be set to 0
- The AXI4 4K address crossing guard is not provided in the CDMA. The 4K address crossing guard must be done by the software application when specifying the Source Address, the Destination Address, and the BTT values programmed into the CDMA registers.

Simple DMA Operation Mode

The basic mode of operation for the CDMA is Simple DMA. In this mode, the CDMA executes one programmed DMA command and then stops. This requires that the CDMA registers need to be set up by an external AXI4 Master for each DMA operation required.

Simple DMA Programming Example

These basic steps describe how to setup and initiate a CDMA transfer in simple operation mode.

1. Verify `CDMASR.IDLE = 1`.
2. Program the `CDMACR.IOC_IrqEn` bit to the desired state for interrupt generation on transfer completion. Also set the error interrupt enable (`CDMACR.ERR_IrqEn`) if so desired.
3. Write the desired transfer source address to the Source Address (SA) Register. The transfer data at the source address must be valid and ready for transfer.
4. Write the desired transfer destination address to the Destination Address (DA) Register.
5. Write the number of bytes to transfer to the CDMA Bytes to Transfer (BTT) Register. Up to 8,388,607 bytes can be specified for a single transfer (unless DataMover Lite is being used). Writing to the BTT register also starts the transfer.
6. Either poll the `CDMASR.IDLE` bit for assertion (`CDMASR.IDLE = 1`) or wait for the CDMA to generate an output interrupt (assumes `CDMACR.IOC_IrqEn = 1`).
7. If interrupt based, determine the interrupt source (transfer completed or an error has occurred).
8. Clear the `CDMASR.IOC_Irq` bit by writing a '1' to the `DMASR.IOC_Irq` bit position.
9. Ready for another transfer. Go back to step 1.

Scatter Gather Operation Mode

Scatter Gather is a mechanism that allows for automated DMA transfer scheduling via a pre-programmed instruction list of transfer descriptors ([Scatter Gather Transfer Descriptor Definition, page 31](#)). This instruction list is programmed by the user software application into a memory-resident data structure that must be accessible by the AXI CDMA SG interface. This list of instructions is organized into what is referred to as a transfer descriptor chain. Each descriptor has an address pointer to the next sequential descriptor to be processed. The last descriptor in the chain generally points back to the first descriptor in the chain but it is not required. The AXI CDMA Tail Descriptor Pointer register needs to be programmed with the address of the first word of the last descriptor of the chain. When the AXI CDMA executes the last descriptor and finds that the Tail Descriptor pointer matches the address of the completed descriptor, the SG Engine stops descriptor fetching and waits (SG is paused).

Transfer Descriptor Management

Prior to starting CDMA Scatter Gather operations, the software application must set up a transfer descriptor chain. After the AXI CDMA begins SG operations, it fetches, processes, and then update the descriptors. By analyzing the descriptors, the software application can track the status of the associated CDMA data transfer and determine the completion status of the transfer. With this information, the software application can manage the transfer descriptors and DMA data buffers.

The software applications should process each DMA data buffer associated with completed descriptor and reallocate the descriptor for AXI CDMA use. To prevent software and hardware from modifying the same descriptor, a Tail Pointer Mode was created. The tail pointer is initialized by software to point to the end of the descriptor chain. This becomes the pause point for hardware. When hardware begins running, it fetches and processes each descriptor in the chain until it reaches the tail pointer. The AXI CDMA then pauses descriptor processing. The software typically then processes and re-allocates any descriptor with the Complete bit set to 1. While the software is processing descriptors, AXI CDMA hardware is prevented from modifying the descriptors being processed by software by the tail pointer. When the software finishes re-allocating a set of descriptors, it then moves the tail pointer location to the end of the re-allocated descriptors by writing to the AXI CDMA TAILDESC register. The act of writing to the TAILDESC register causes the AXI CDMA hardware, if it is paused at the tail pointer, to begin processing descriptors again. If the AXI CDMA hardware is not paused at the TAILDESC pointer, writing to the TAILDESC register has no effect on the hardware. In this situation, the AXI CDMA continues to process descriptors until reaching the new tail descriptor pointer location.

Scatter Gather Transfer Descriptor Definition

This section defines the format and contents of the AXI CDMA Scatter Gather Transfer Descriptors. These are used only by the SG function if it is enabled in the CDMA by assigning the parameter C_INCLUDE_SG a value of 1 and the CDMACR.SGMode bit is set to 1. A transfer descriptor consists of eight 32-bit words. The descriptor represents the control and status information needed for a single CDMA transfer plus address linkage to the next sequential descriptor. Each descriptor can define a single CDMA transfer of up to 8,388,607 Bytes of data. A descriptor chain is defined as a series of descriptors that are sequentially linked via the address linkage built into the descriptor format. The AXI CDMA SG Engine traverses the descriptor chain following the linkage until the last descriptor of the chain has been completed. The relationship and identification of the AXI CDMA transfer descriptor words is shown in [Table 13](#).

Note: Transfer Descriptors must be aligned on 16 32-bit word alignment. Example valid offsets are 0x00, 0x40, 0x80, 0xC0, etc.

Table 13: Transfer Descriptor Word Summary

Address Space Offset ⁽¹⁾	Name	Description
00h	NXTDESC_PNTR	Next Descriptor Pointer
04h	RESERVED	N/A
08h	SA	Source Address
0Ch	RESERVED	N/A
10h	DA	Destination Address
14h	RESERVED	N/A
18h	CONTROL	Transfer Control
1Ch	STATUS	Transfer Status

1. Address Space Offset is relative to the address of the first word of the Transfer Descriptor in system memory.

Transfer Descriptor NXTDESC_PNTR (Next Descriptor Pointer - Offset 00h)

This word provides the address pointer to the first word of the next transfer descriptor in the descriptor chain.

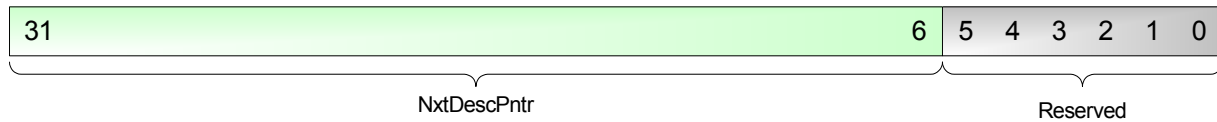

Figure 11: Transfer Descriptor NXTDESC_PNTR Word

Table 14: Transfer Descriptor NXTDESC_PNTR Word Details

Bits	Field Name	Description
5 to 0	Reserved	These bits are reserved and fixed to zeros. This forces the address value programmed in this register to be aligned to 128-byte aligned addresses.
31 to 6	NxtDescPntr	Next Descriptor Pointer. This field is an address pointer (most significant 26 bits) to the first word of the next transfer descriptor to be executed by the CDMA SG Engine. Note: The least-significant 6 bits of this register are appended to this value when used by the SG Engine forcing transfer descriptors to be loaded in memory at 128-byte address alignment.

Transfer Descriptor SA Word (Source Address - Offset 08h)

This word provides the starting address for the data read operations for the associated DMA transfer.

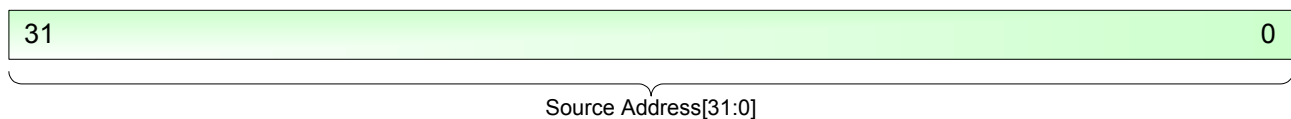

Figure 12: Transfer Descriptor SA Word

Transfer Descriptor DA Word (Destination Address - Offset 10h)

Table 15: Transfer Descriptor SA Word Details

Bits	Field Name	Description
31 to 0	DA	Source Address. This value specifies the starting address for data read operations for the associated DMA transfer. The address value can be at any byte offset.

This word provides the starting address for the data write operations for the associated DMA transfer.



Figure 13: Transfer Descriptor DA Word

Table 16: Transfer Descriptor DA Word Details

Bits	Field Name	Description
31 to 0	DA	Destination Address. This value specifies the starting write address for DMA data transfers. The address value has restrictions relative to the Source Address and AXI CDMA DRE inclusion. Note: If DRE is not included in the AXI CDMA (C_INCLUDE_DRE = 0) or the specified CDMA data width is not supported by DRE (C_M_AXI_DATA_WIDTH = 128 or 256), then the address offset of the Destination Address must match that of the Source Address value.

Transfer Descriptor CONTROL Word (Control - Offset 18h)

This value provides control for the AXI CDMA transfer.

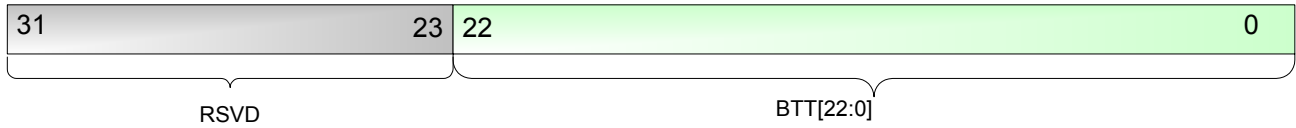

Figure 14: Transfer Descriptor CONTROL Word

Table 17: Transfer Descriptor CONTROL Word Details

Bits	Field Name	Description
22 to 0	BTT	Bytes to Transfer. This field in the Control word specifies the desired number of bytes to DMA from the Source Address to the Destination Address. A maximum of 8,388,607 bytes of data can be specified by this field for the associated transfer. Note: A value of zero (0) is not allowed and causes a DMA internal error to be set by AXI CDMA.
31 to 23	Reserved	These bits are reserved and should be set to zero.

Transfer Descriptor STATUS Word (Status - Offset 1Ch)

This value provides status to the software application regarding the execution of the Transfer Descriptor by the AXI CDMA. This Status word should be zeroed when the transfer descriptor is programmed by the software application. When the AXI CDMA SG Engine has completed execution of the transfer descriptor, the Status word is updated and written back to the original Status word location in memory by the SG Engine.

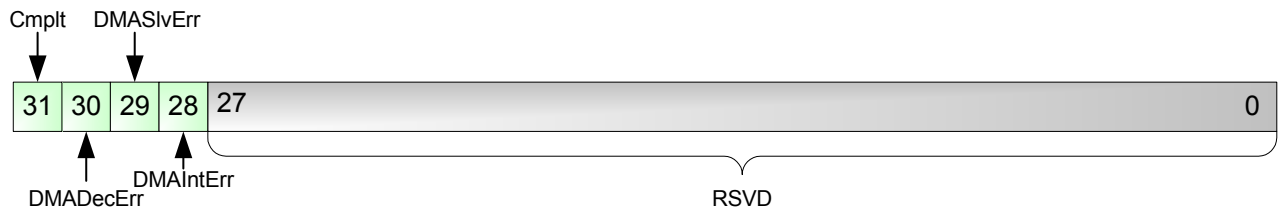

Figure 15: Transfer Descriptor STATUS Word

Table 18: Transfer Descriptor STATUS Word Details

Bits	Field Name	Description
27 to 0	Reserved	These bits are reserved and should be set to zero.
28	DMAIntErr	<p>DMA Internal Error. This bit indicates that an internal error was encountered by the AXI CDMA DataMover on the data transport channel during the execution of this descriptor. This error can occur if a 0 value BTT (bytes to transfer) is fed to the AXI DataMover or DataMover has an internal processing error. A BTT of 0 only happens if the BTT field in the transfer descriptor CONTROL word is programmed with a value of zero. This error condition causes the AXI CDMA to gracefully halt. The CDMASR.Idle bit is set to 1 when the CDMA has completed shut down.</p> <ul style="list-style-type: none"> 0 = No CDMA Internal Errors. 1 = CDMA Internal Error detected. CDMA Engine halts at this descriptor.
29	DMASlvErr	<p>DMA Slave Error. This bit indicates that a AXI slave error response was received by the AXI CDMA DataMover during the AXI transfer (read or write) associated with this descriptor. This error condition causes the AXI CDMA to gracefully halt.</p> <ul style="list-style-type: none"> 0 = No CDMA Slave Errors. 1 = CDMA Slave Error received. CDMA Engine halts at this descriptor.
30	DMADecErr	<p>DMA Decode Error. This bit indicates that an AXI decode error was received by the AXI CDMA DataMover. This error occurs if the DataMover issues an address that does not have a mapping assignment to a slave device. This error condition causes the AXI CDMA to gracefully halt.</p> <ul style="list-style-type: none"> 0 = No CDMA Decode Errors. 1 = CDMA Decode Error received. CDMA Engine halts at this descriptor.
31	Cmplt	<p>Transfer Completed. This indicates to the software application that the CDMA Engine has completed the transfer as described by the associated descriptor. The software application may manipulate any descriptor with the Completed bit set to 1 when in Tail Pointer Mode (currently the only supported mode).</p> <ul style="list-style-type: none"> 0 = Descriptor not completed. 1 = Descriptor completed. <p>Note: If the CDMA SG Engine fetches a descriptor is with this bit set to 1, the descriptor is considered a stale descriptor. An SGIntErr is flagged in the AXI CDMA Status Register and the AXI CDMA engine halts with no update to the descriptor.</p>

Example Transfer Descriptor Usage

The following example illustrates a typical procedure for using the AXI CDMA Scatter Gather feature. The example transfer descriptor chain contains ten transfer descriptors as shown in [Figure 16](#).

SG Initialization Sequence

- The software application verifies that the CDMA is idle (CDMASR.Idle=1).
- The transfer descriptors are initialized in the system memory by the software application. The descriptors are arranged into a ring with each NXTDESC_PNTR word pointing to the starting memory address of the next sequential transfer descriptor. Each transfer descriptor describes a single DMA operation via the Source Address (SA) word, the Destination Address (DA) word, and the BTT field in the Control word.
- The software application writes the CDMA Control Register (CDMACR) with the appropriate controls set. This must include setting the CDMACR.SGMode = '1'. IRQDelay and IRQThreshold can be overridden if desired. Interrupt enabling can be set, if desired.

- The software application initializes the CDMA CURDESC_PNTR register with the starting memory address of the first transfer descriptor in the chain (address of TD1 NXTDESC_PNTR word).
Note: The CURDESC_PNTR and the NXTDESC_PNTR registers are cleared when CDMACR.SGMode = '0'. The SW Application must reprogram these registers when the CDMACR.SGMode = '1'. This is required due to internal initialization signalling sent to the SG Engine when these registers are written with values.
- The software application initializes the CDMA TAILDESC_PNTR register with the starting memory address of the last transfer descriptor in the chain (TD10). Writing to this register also starts the CDMA operations.

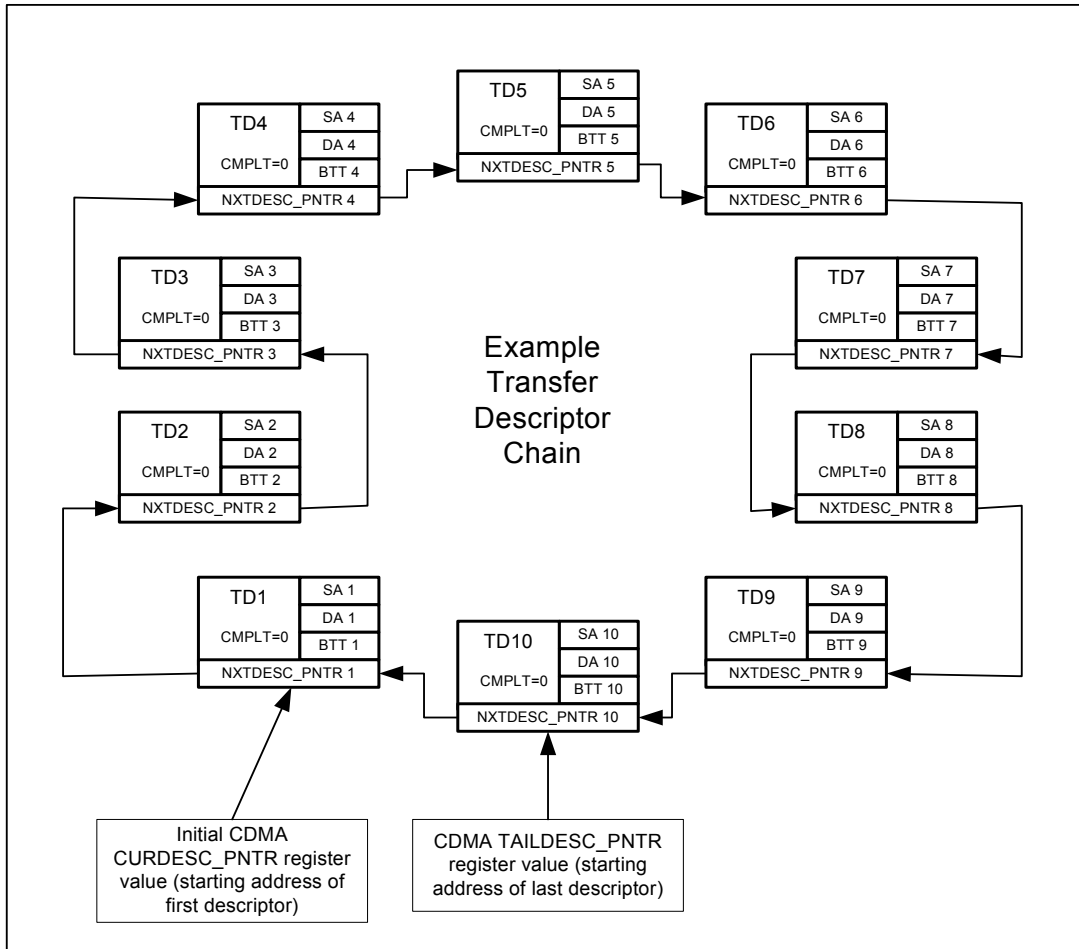

Figure 16: Transfer Descriptor Chain Initialization

Transfer Descriptor Execution Start-Up

- The AXI CDMA starts SG operations when the TAILDESC_PNTR register is written by the software application. The value written should be the starting address of the last TD in the chain to be executed. The SG operation begins by the CDMA fetching the first transfer descriptor at the address loaded into the CDMA CURDESC_PNTR register. See Figure 17.
- The AXI CDMA sequentially fetches descriptors until the internal scatter gather fetch queue is full, as indicated by the shaded boxes or the TD at the TAILDESC_PNTR register address is completed.
- In sequential order, the CDMA pulls descriptors from the fetch queue and programs the DataMover with each transfer described by the descriptor. The CDMA CURDESC_PNTR register is updated by the SG function to reflect the actual descriptor being processed by the engine. This register can be read by the software application but the value will be changing while CDMASR.Idle = 0.

Note: On error, the CDMA engine halts and the CURDESC_PNTR register is updated to the address of the transfer descriptor associated with the error.

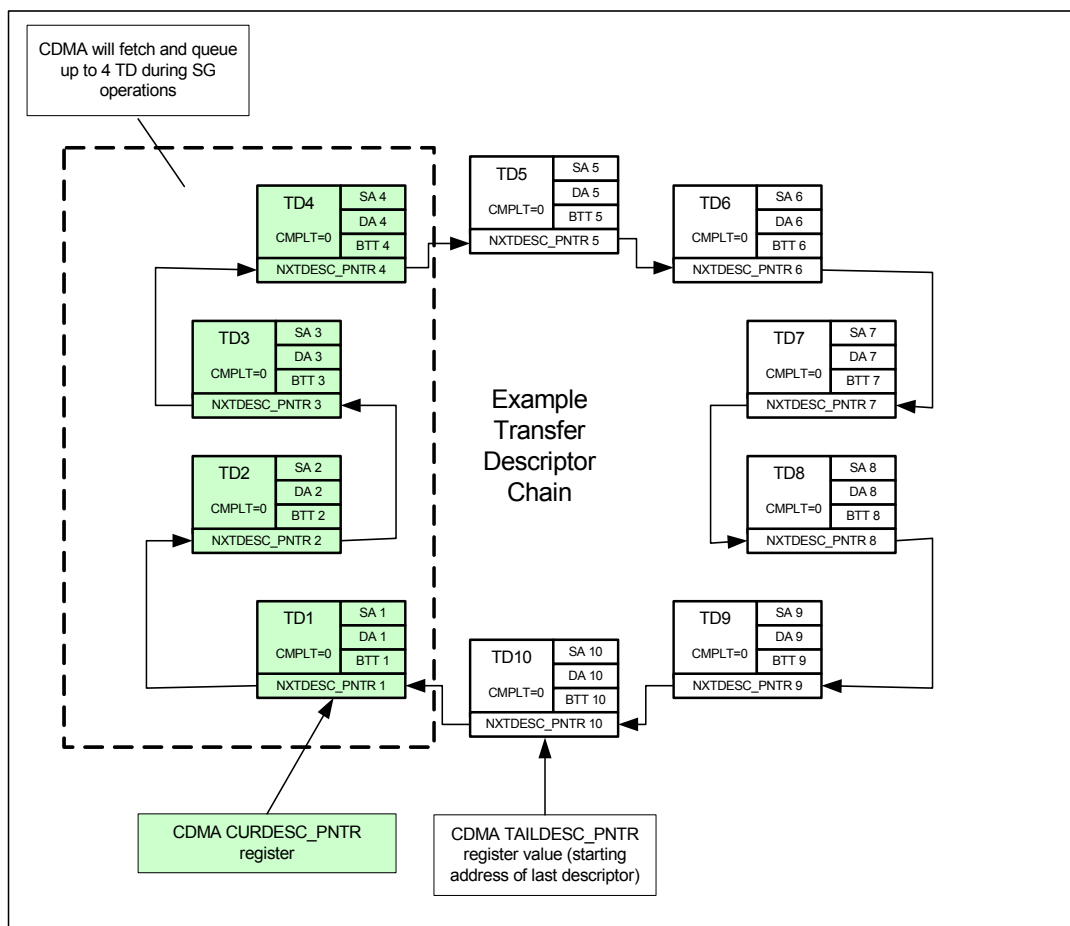

Figure 17: Transfer Descriptor Execution Startup

Transfer Descriptor Update

- When the DMA transfer associated with a descriptor is finished by the CDMA DataMover function, the status of the transfer is scored by the CDMA SG function and then written into the STATUS word of the associated descriptor in system memory. The updated STATUS word also has the Cmplt bit set to 1 indicating the CDMA has completed processing of the descriptor. This is shown in Figure 18.
- When the update of a descriptor is completed, the descriptor is popped from the internal CDMA queue. This opens up room for a new descriptor to be fetched and added to the internal queue. As long as there is room for a descriptor to be stored in the fetch queue, descriptors continue to be fetched by the CDMA Scatter Gather function. Descriptor fetches and updates occur in sequential order defined by the descriptor linkage pointers (NXTDESC_PNTR).
- A descriptor that is marked as completed by the CDMA is available for the software application to reuse for future transfer automation. The CDMA does not proceed past the descriptor at the address indicated by the CDMA TAILDESC_PNTR register.

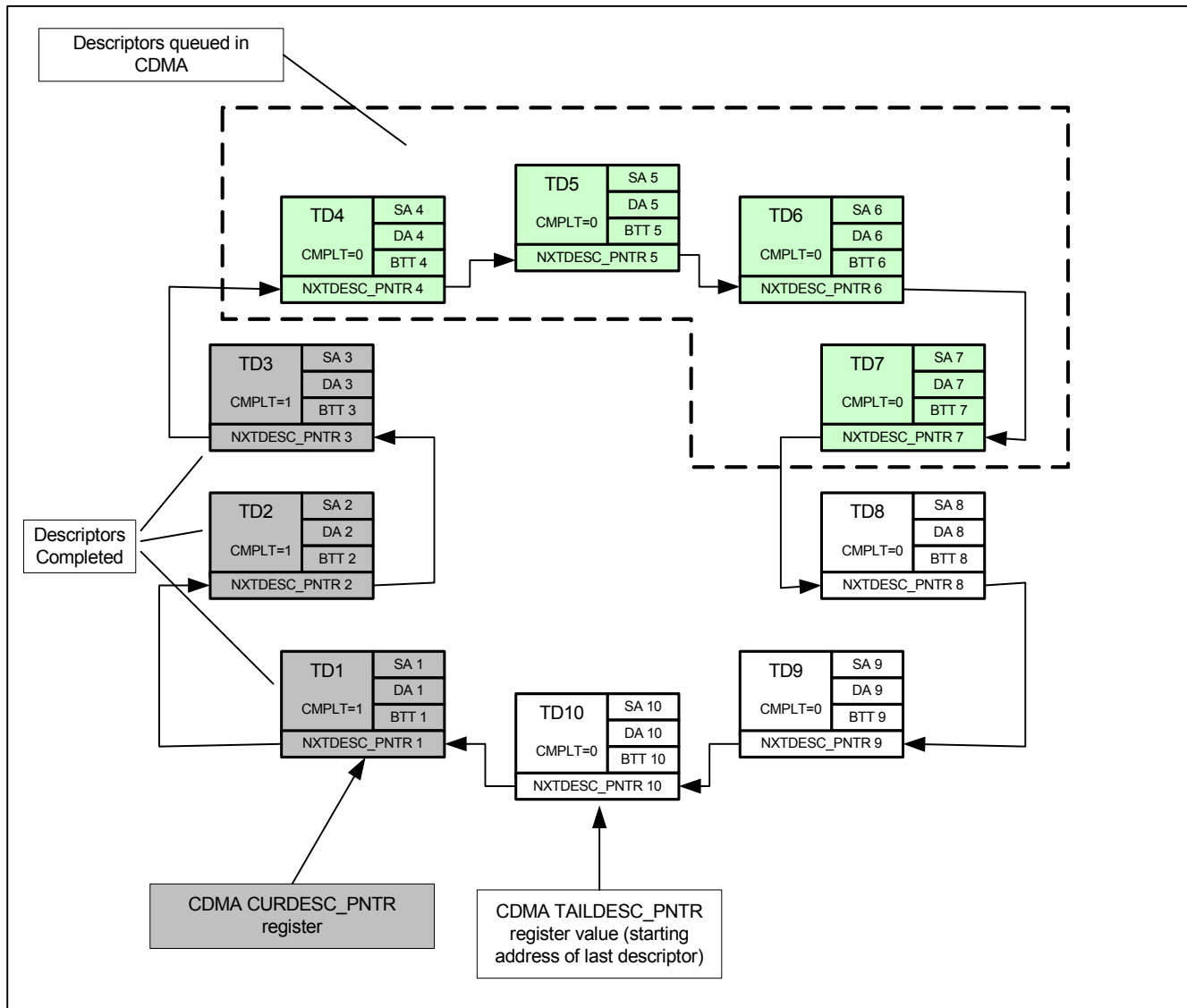

Figure 18: Continued Execution

Transfer Descriptor Reuse

- When the software application has recognized the completed descriptor and performed any necessary processing associated with it, the application can re-allocate the descriptors by adjusting the SA, DA, BTT, NXTDESC_PNTR, and zeroing out the STATUS word. This is depicted in Figure 19.
- After re-allocating the descriptors, the software application has the option of moving the TAILDESC_PNTR to point to the address of the last re-allocated descriptor or keeping it at the original end of chain value. This is up to the application requirements.
- If AXI CDMA is paused (CDMASR.Idle=1) because it has encountered the transfer descriptor with the starting address matching the CDMA TAILDESC_PNTR register value, it automatically re-starts descriptor fetching when the software application writes the new CDMA TAILDESC_PNTR register value. The next descriptor fetched is the one pointed to by the NXTDESC_PNTR value of the descriptor when the pause occurred.

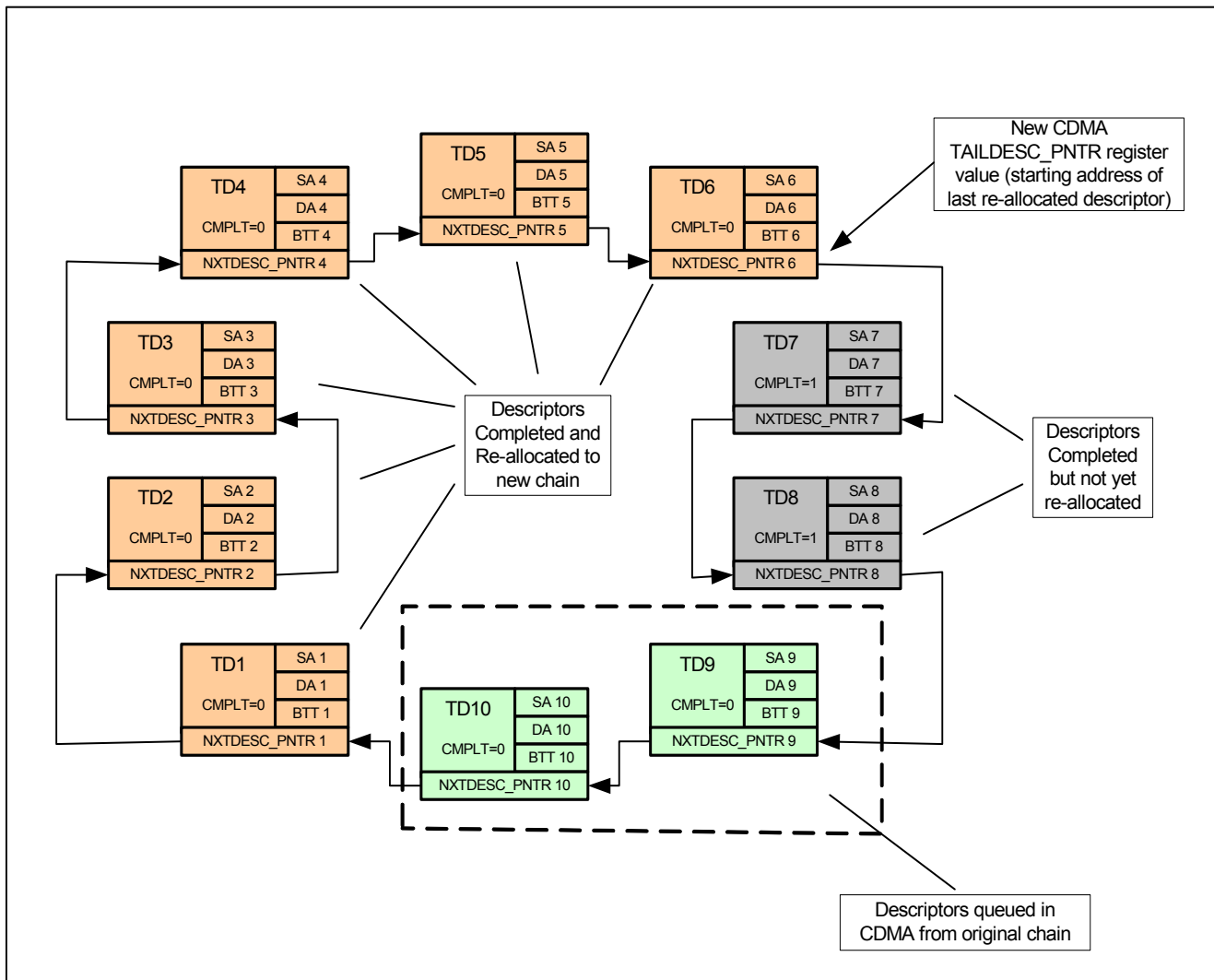

Figure 19: Transfer Descriptor Re-Allocation

CDMA Scatter Gather Restart and Pause Behavior

The CDMA Scatter Gather engine has two different ways in which to continue SG operation after it has paused at a tail pointer descriptor. The first method is to re-allocate transfer descriptors in the chain that is currently active. The software application merely writes the address of the last re-allocated transfer descriptor to the CDMA TAILDESC_PNTR register. This causes the CDMA SG engine to continue sequencing through the re-allocated descriptor chain until the next tail pointer location is hit. However, it is sometimes advantageous for a software application to have a different descriptor chain set up somewhere else in memory that needs to be executed after the CDMA has hit the initial tail descriptor. To do this, the CDMA SG must be restarted after the CDMA SG has paused and the CDMASR.Idle bit is set. At that point, the application must set the CDMACR.SGMode bit to '0'. Then the process described in the section [SG Initialization Sequence](#) should be followed again. The starting descriptor address of the new chain must be written to the CDMA CURDESC_PNTR register during the initialization process.

Interrupt Generation

An interrupt output is provided by the AXI CDMA. This output drives high when an internal interrupt event is logged in the CDMA Status Register (CDMASR) and the associated interrupt enable bit is set in the CDMA Control Register (CDMACR).

Important: This interrupt output is synchronized to the `s_axi_lite_aclk` clock input.

Internal interrupt events are different depending on whether the AXI CDMA is operating in Simple DMA mode or SG Mode. Simple DMA mode generates an IOC interrupt whenever a programmed transfer is completed. In addition, three error conditions reported by the DataMover (internal error, slave error, and decode error) can also generate an interrupt assertion. For Scatter Gather mode, the delay interrupt and the three SG engine error interrupt events are added to the interrupt event mix.

SG Interrupt Threshold and Interrupt Coalescing

The use of Scatter Gather automation greatly improves DMA operational throughput by removing the system CPU from the real time control of the AXI CDMA. However, this improved transfer throughput can overwhelm the CPU with transfer completion interrupts. This is solved by providing a programmable filter method called interrupt coalescing. The AXI CDMA interrupt coalescing feature is enabled by setting the CDMACR.IRQThreshold field to a value greater than the default value of 1. When a SG session is started in the CDMA, the CDMACR.IRQThreshold field is loaded into the SG Engine threshold counter. With each Interrupt On Complete event generated by the SG Engine (occurs whenever the AXI CDMA completes a transfer descriptor), the threshold count is decremented. When the count reaches zero, an IOC_Irq is generated by the SG Engine. If the CDMACR.IOC_IrqEn = 1, an interrupt is generated on the AXI CDMA `cdma_introut` signal. When a threshold interrupt is generated, the programmed threshold count is reloaded into the SG Engine threshold counter in preparation for the next threshold event. The real time internal threshold count value in the SG engine is provided to the software application in the CDMASR.IRQThresholdSts field of the CDMA status register. A CDMACR.IRQThreshold value of 0x01 (default value) causes the SG Engine to generate an interrupt for every transfer descriptor executed (disabling the coalescing feature).

If the delay interrupt feature is enabled (CDMACR.IRQDelay not equal to 0), a delay interrupt event causes a reload of the SG Engine interrupt threshold counter. In addition, a write by the software application to the threshold value (CDMACR.Threshold), the internal threshold counter is reloaded.

SG Delay Interrupt

The delay interrupt feature is used in conjunction with the interrupt coalescing filter. Using the delay interrupt feature allows the software application to guarantee it receives an interrupt from the AXI CDMA when the interrupt threshold is not met but the programmed descriptor chain has been completely processed by the AXI CDMA. The delay interrupt timer feature is enabled by setting the CDMACR.IRQDelay value to a non-zero value. The delay time is loaded into an internal counter in the SG Engine when a SG session is started. The internal timer begins counting up whenever the AXI CDMA is idle (CDMASR.Idle = '1'). The delay timer is reset and halted whenever the AXI CDMA is not idle (CDMASR.Idle = '0'). A delay interrupt event occurs when the AXI CDMA is idle long enough for the internal delay counter in the SG Engine to count up to and equal the programmed delay count value. If a delay interrupt event occurs, the SG Engine delay timer is reset to zero (CDMASR.IRQDelaySts=0x00), and the delay timer does not count until the CPU services the delay interrupt by clearing the CDMASR.Dly_Irq bit to 0.

Error Interrupts

Any detected error results in the AXI CDMA gracefully halting. Per AXI4 protocol, all AXI transfers that have been committed with accepted address channel transfers must complete the associated data transfer. Therefore, the AXI CDMA completes all committed AXI4 transfers before setting the CDMASR.Idle bit. When the CDMASR.Idle bit is set to 1, the AXI CDMA engine is truly halted.

The pointer to the descriptor associated with the errored transfer is updated to the CURDESC_PNTR register. On the rare occurrence that more than one error is detected, only the CURDESC_PNTR register for one of the errors are logged. To resume operations, a reset must be issued to the AXI CDMA either via a hardware reset (m_axi_aresetn = '0') or by writing a '1' to the CDMACR.Reset bit.

The following is a list of possible errors:

- **DMAIntErr.** CDMA Internal Error indicates that an internal error in the AXI DataMover was detected. This can occur under two conditions. First, for the DataMover MM2S and S2MM channels, it can occur when a BTT = 0 is written to the primary AXI DataMover command input. This would happen if a transfer descriptor is fetched and executed with the CONTROL word having the BTT field = 0.
- **DMASlvErr.** CDMA Slave Error occurs when the slave to or from which data is transferred responds with a SLVERR.
- **DMADecErr.** CDMA Decode Error occurs when the address request is targeted to an address that does not exist.
- **SGIntErr.** Scatter Gather Internal Error occurs when a BTT = 0. This error only occurs if a fetched descriptor already has the Complete bit set. This condition indicates to the AXI CDMA that the descriptor has not been processed by the CPU, and therefore is considered stale.
- **SGSlvErr.** Scatter Gather Slave Error occurs when the slave to or from which descriptors are fetched and updated responds with a SLVERR.
- **SGDecErr.** Scatter Gather Decode Error occurs when the address request is targeted to an address that does not exist.

Note: Scatter Gather error bits are unable to be updated to the descriptor in remote memory. They are only captured in the associated channel CDMASR where the error occurred.

Automatic Constraint Generation

The AXI CDMA v3_01_a incorporates a TCL file that automatically generates “DATAPATHONLY” constraints between the `m_axi_aclk` and the `s_axi_lite_aclk` domains. This only occurs when the parameter `C_AXI_LITE_IS_ASYNC` is assigned a value of 1 indicating the `m_axi_aclk` and `s_axi_lite_aclk` input ports are being driven with different clocks.

Clocking

AXI CDMA v3_01_a utilizes two clocks for logic synchronization. The primary clock used for the main data transport synchronization is input on the `m_axi_aclk` input port. All interfaces for the core (other than the AXI4-Lite register interface) are required to be synchronized to this clock. The clock for the AXI4-Lite register interface is input on the `s_axi_lite_aclk` input. It is used only for the AXI4-Lite interface. The parameter `C_AXI_LITE_IS_ASYNC` is used by the AXI4-Lite interface logic. If the parameter is assigned a value of 1 (asynchronous mode), then the AXI4-Lite clock (`s_axi_lite_aclk`) is not the same clock as that input on the `m_axi_aclk` port. In this configuration, the `s_axi_lite_aclk` is required to have a frequency that is equal to or less than that for the `m_axi_aclk` frequency. If the parameter `C_AXI_LITE_IS_ASYNC` is assigned a value of 0, then it is required that the `s_axi_lite_aclk` and the `m_axi_aclk` be the same clock. The AXI CDMA has been simulation tested with an `s_axi_lite_aclk` and `m_axi_aclk` frequency range of 50 MHz to 200 MHz. Actual F_{max} achieved in a hardware implementation might vary. See the [Performance](#) section.

Resets

AXI CDMA v3_01_a utilizes two hardware resets for logic initialization. An active low reset assertion on the CDMA `m_axi_aresetn` input or the `s_axi_lite_aresetn` input results in a reset of the entire AXI CDMA core logic. This is considered a hardware reset and there are no graceful completions of AXI4 transfers in progress. A hardware reset initializes all AXI CDMA registers to the default state, all internal queues are flushed, and all internal logic is returned to power on conditions. It is required that the `m_axi_aresetn` input is synchronous to the `m_axi_aclk` master clock input and the `s_axi_lite_aresetn` input be synchronous to the `s_axi_lite_aclk` input. The required reset assertion times are stated in [Table 19](#). The table also indicates the stabilization time for AXI CDMA outputs reacting to a reset conditions.

Table 19: Reset Assertion/Deassertion Stabilization Times

Description	Value	Applicable Signal
C_AXI_LITE_IS_ASYNC = 0		
Minimum assertion time	8 clocks (<code>m_axi_aclk</code>)	<code>m_axi_aresetn</code> input
Minimum assertion time	8 clocks (<code>m_axi_lite_aclk</code>)	<code>m_axi_lite_resetn</code> input
<code>m_axi_aresetn</code> assertion to output signals in reset state (maximum)	3 clocks (<code>m_axi_aclk</code>)	All output signals
Reset de-assertion to normal operation state (maximum)	3 clocks (<code>m_axi_aclk</code>)	All output signals

Table 19: Reset Assertion/Deassertion Stabilization Times (Cont'd)

Description	Value	Applicable Signal
m_axi_lite_resetrn assertion to output signals in reset state (maximum)	3 clocks (m_axi_aclk = m_axi_lite_aclk)	All output signals
m_axi_lite_resetrn de-assertion to normal operation state (maximum)	3 clocks (m_axi_aclk = m_axi_lite_aclk)	All output signals
C_AXI_LITE_IS_ASYNC = 1		
Minimum assertion time	8 clocks (m_axi_aclk)	m_axi_aresetrn input
Minimum assertion time	8 clocks (m_axi_lite_aclk)	m_axi_lite_resetrn input
m_axi_aresetrn assertion to output signals in reset state (maximum)	3 clocks (m_axi_aclk)	All output signals
Reset de-assertion to normal operation state (maximum)	3 clocks (m_axi_aclk)	All output signals
m_axi_lite_resetrn assertion to output signals in reset state (maximum)	1 m_axi_lite_aclk plus 5 m_axi_aclk clocks	All output signals
m_axi_lite_resetrn de-assertion to normal operation state (maximum)	1 m_axi_lite_aclk plus 5 m_axi_aclk clocks	All output signals

Performance

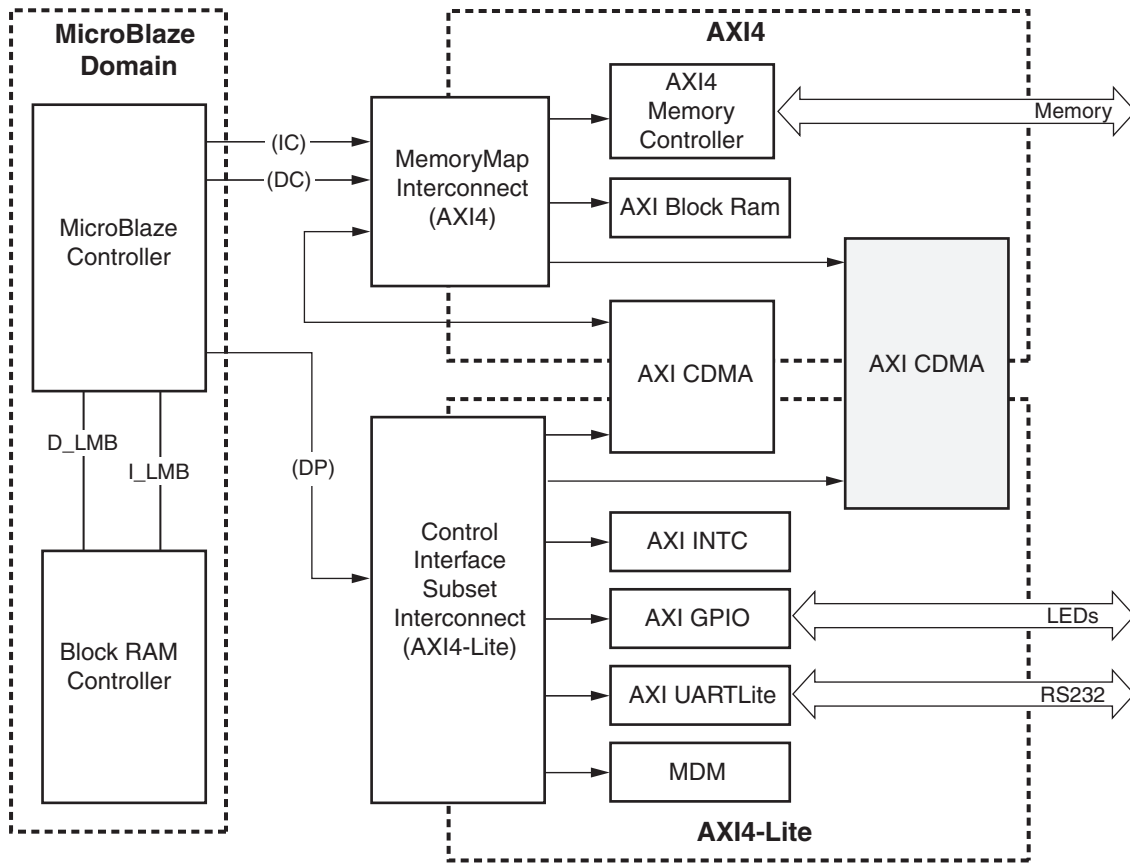

Figure 20: Virtex-6 and Spartan-6 FPGA System Configuration Diagram

The target FPGA was filled with logic to drive the LUT and block RAM utilization to approximately 70% and the I/O utilization to approximately 80%. Using the default tool options and the slowest speed grade for the target FPGA, the resulting target F_{MAX} numbers are shown in Table 20.

Table 20: System Performance

Target FPGA	Target F_{MAX} (MHz)		
	AXI4	AXI4-Lite	MicroBlaze
xc6slx45t (1)	90	120	80
xc6vlx240t (2)	135	180	135

Notes:

1. Spartan-6 LUT utilization: 70%; Block RAM utilization: 70%; I/O utilization: 80%; MicroBlaze not AXI4 interconnect; AXI4 interconnect configured with a single clock of 120 MHz.
2. Virtex-6 LUT utilization: 70%; Block RAM utilization: 70%; I/O utilization: 80%.

Throughput

Due to the parameterizable nature of the AXI CDMA, throughput is best measured as a percentage of the AXI4 bus bandwidth available to the AXI CDMA. This available bus bandwidth is a function of the clock frequency of the AXI4 bus and the parameterized data width of the AXI CDMA. The other parameter affecting throughput is the value assigned to the C_M_AXI_BURST_LEN parameter of the AXI CDMA. In general, the bigger value assigned increases the realized throughput of the AXI CDMA. However, larger burst lengths can be detrimental to other components of a user's system design (causing lower system performance) so this is a trade-off that the user must evaluate.

Table 21: AXI CDMA Throughput

C_M_AXI_BURST_LEN	Test Packet Size	AXI4 Frequency (m_axi_ack input in Virtex-6 FPGA)	Observed Bus Bandwidth Utilization by AXI CDMA
16	9000 bytes	150 MHz	70%
64	9000 bytes	150 MHz	up to 99%

Resource Utilization

Resource utilization numbers for the AXI CDMA core are shown for the Spartan-6 FPGA family in [Table 22](#) and for the Virtex-6 FPGA family in [Table 23](#). These values have been generated using the Xilinx EDK and ISE[®] tools for version 13.2. They are derived from ISE software Map reports from actual hardware validation systems. Parameter combinations shown are not all that are possible but are chosen to represent a range of minimum utilization (low performance) to high utilization (high performance).

Table 22: Spartan-6 FPGA Resource Estimates

C_M_AXI_DATA_WIDTH	C_MAX_BURST_LEN	C_INCLUDE_DRE	C_INCLUDE_SG	C_USE_DATA_MOVER_LITE	C_INCLUDE_SF	C_AXI_LITE_IS_ASYNC	C_READ_ADDR_PIPE_DEPTH	C_WRITE_ADDR_PIPE_DEPTH	Slices	Slice Reg	Slice LUTs	Block RAM
32	16	0	0	1	1	0	4	4	442	1030	682	2
32	16	0	0	0	1	0	4	4	591	1385	1042	2
32	16	1	0	0	1	0	4	4	720	1512	1174	2
64	256	1	0	0	1	0	4	4	934	2050	1583	9
256	256	0	0	0	1	0	4	4	1194	3851	2209	33
32	16	0	1	0	1	0	4	4	1210	2746	2059	3
64	128	1	1	0	1	0	4	4	1536	3408	2622	10
256	256	0	1	0	1	0	4	4	1854	5213	3316	34

Table 23: Virtex-6 FPGA Resource Estimates

C_M_AXI_DATA_WIDTH	C_MAX_BURST_LEN	C_INCLUDE_DRE	C_INCLUDE_SG	C_USE_DATAOVER_LITE	C_INCLUDE_SF	C_AXI_LITE_IS_ASYNC	C_READ_ADDR_PIPE_DEPTH	C_WRITE_ADDR_PIPE_DEPTH	Slices	Slice Reg	Slice LUTs	Block RAM
32	16	0	0	1	1	0	4	4	506	1059	743	1
32	16	0	0	0	1	0	4	4	657	1424	1024	1
32	16	1	0	0	1	0	4	4	720	1550	1164	1
64	256	1	0	0	1	0	4	4	1011	2083	1639	5
256	256	0	0	0	1	0	4	4	1236	3865	2442	17
32	16	0	1	0	1	0	4	4	1377	2817	2135	2
64	128	1	1	0	1	0	4	4	1708	3476	2750	6
256	256	0	1	0	1	0	4	4	1964	5258	3424	18

Support

Xilinx provides technical support for this LogiCORE™ IP product when used as described in the product documentation. Xilinx cannot guarantee timing, functionality, or support of product if implemented in devices that are not defined in the documentation, if customized beyond that allowed in the product documentation, or if changes are made to any section of the design labeled *DO NOT MODIFY*.

Ordering Information

This Xilinx LogiCORE IP module is provided at no additional cost with the Xilinx ISE Design Suite Embedded Edition software under the terms of the [Xilinx End User License](#). The core is generated using the Xilinx ISE Embedded Edition software (EDK).

Information about this and other Xilinx LogiCORE IP modules is available at the [Xilinx Intellectual Property](#) page. For information on pricing and availability of other Xilinx LogiCORE IP modules and software, contact your [local Xilinx sales representative](#).

Reference Documents

The following document contains reference information important to understanding the design:

[AXI4 AMBA® AXI Protocol Version: 2.0 Specification](#)

List of Acronyms

Acronym	Spelled Out
AMBA	Advanced Microcontroller Bus Architecture
ARM	Advanced RISC Machine
AXI	Advanced eXtensible Interface
BTT	Bytes To Transfer
CDMA	Central Direct Memory Access
CPU	Central Processing Unit
DA	Destination Address
DMA	Direct Memory Access
DRE	Data Realignment Engine
DSP	Digital Signal Processing
EDK	Embedded Development Kit
FF	Flip-Flop
FIFO	First In First Out
FPGA	Field Programmable Gate Array
I/O	Input/Output
IP	Intellectual Property
IOC	Interrupt On Complete
LUT	Lookup Table
MHz	Mega Hertz
MM2S	Memory Map to Stream
R/W	Read/Write
R/WC	Read / Write to Clear
RAM	Random Access Memory
RO	Read Only
S2MM	Stream to Memory Map
SA	Source Address
SF	Store and Forward
SG	Scatter/Gather
SW	Software
TCL	Tool Command Language
TD	Transfer Descriptor
VHDL	VHSIC Hardware Description Language (VHSIC an acronym for Very High-Speed Integrated Circuits)
XPS	Xilinx Platform Studio (part of the EDK software)
XST	Xilinx Synthesis Technology

Revision History

Date	Version	Description of Revisions
09/21/10	1.0	Initial Xilinx Release
12/14/10	2.0	EDK 12.4 Release for axi_cdma_v2_00_a
03/01/11	3.0	EDK 13.1 Release for axi_cdma_3_00_a
06/22/11	3.0.1	EDK 13.2 Release for axi_cdma_3_01_a
06/22/11	3.1	Documentation Only: <ul style="list-style-type: none">• Added Virtex-7 and Kintex-7 to IP Facts table.• Corrected last version number in Document Revision History table to “3.0.1” instead of “3.01”

Notice of Disclaimer

The information disclosed to you hereunder (the “Materials”) is provided solely for the selection and use of Xilinx products. To the maximum extent permitted by applicable law: (1) Materials are made available “AS IS” and with all faults, Xilinx hereby DISCLAIMS ALL WARRANTIES AND CONDITIONS, EXPRESS, IMPLIED, OR STATUTORY, INCLUDING BUT NOT LIMITED TO WARRANTIES OF MERCHANTABILITY, NON-INFRINGEMENT, OR FITNESS FOR ANY PARTICULAR PURPOSE; and (2) Xilinx shall not be liable (whether in contract or tort, including negligence, or under any other theory of liability) for any loss or damage of any kind or nature related to, arising under, or in connection with, the Materials (including your use of the Materials), including for any direct, indirect, special, incidental, or consequential loss or damage (including loss of data, profits, goodwill, or any type of loss or damage suffered as a result of any action brought by a third party) even if such damage or loss was reasonably foreseeable or Xilinx had been advised of the possibility of the same. Xilinx assumes no obligation to correct any errors contained in the Materials or to notify you of updates to the Materials or to product specifications. You may not reproduce, modify, distribute, or publicly display the Materials without prior written consent. Certain products are subject to the terms and conditions of the Limited Warranties which can be viewed at <http://www.xilinx.com/warranty.htm>; IP cores may be subject to warranty and support terms contained in a license issued to you by Xilinx. Xilinx products are not designed or intended to be fail-safe or for use in any application requiring fail-safe performance; you assume sole risk and liability for use of Xilinx products in Critical Applications: <http://www.xilinx.com/warranty.htm#critapps>.