

LogiCORE IP RGB to YCrCb Color-Space Converter v6.01a

Product Guide

PG013 October 16, 2012

Table of Contents

SECTION I: SUMMARY

IP Facts

Chapter 1: Overview

Feature Summary	7
Applications	8
Licensing and Ordering Information	8

Chapter 2: Product Specification

Standards	9
Performance	9
Resource Utilization	10
Core Interfaces and Register Space	12

Chapter 3: Designing with the Core

General Design Guidelines	27
Color-Space Conversion Background	28
Clock, Enable, and Reset Considerations	36
System Considerations	38

Chapter 4: C-Model Reference

Installation and Directory Structure	41
Using the C-Model	43
Compiling with the RGB to YCrCb C-Model	48

SECTION II: VIVADO DESIGN SUITE

Chapter 5: Customizing and Generating the Core

Graphical User Interface	51
Output Generation	56

Chapter 6: Constraining the Core

Required Constraints	57
Device, Package, and Speed Grade Selections	57
Clock Frequencies	58
Clock Management	58
Clock Placement	58
Banking	58
Transceiver Placement	58
I/O Standard and Placement	58

Chapter 7: Detailed Example Design

Demonstration Test Bench	59
--------------------------------	----

SECTION III: ISE DESIGN SUITE

Chapter 8: Customizing and Generating the Core

Graphical User Interface	66
Parameter Values in the XCO File	71
Output Generation	72

Chapter 9: Constraining the Core

Required Constraints	74
Device, Package, and Speed Grade Selections	74
Clock Frequencies	75
Clock Management	75
Clock Placement	75
Banking	75
Transceiver Placement	75
I/O Standard and Placement	75

Chapter 10: Detailed Example Design

Demonstration Test Bench	76
Test Bench Structure	76
Running the Simulation	77
Directory and File Contents	77

SECTION IV: APPENDICES

Appendix A: Verification, Compliance, and Interoperability

Simulation	80
Hardware Testing	80
Interoperability	81

Appendix B: Migrating

Appendix C: Debugging

Bringing up the AXI4-Lite Interface	83
Bringing up the AXI4-Stream Interfaces	84
Debugging Features	85
Interfacing to Third-Party IP	87

Appendix D: Application Software Development

Programmer's Guide	89
--------------------------	----

Appendix E: Additional Resources

Xilinx Resources	93
Solution Centers	93
References	94
Technical Support	94
Revision History	95
Notice of Disclaimer	95

SECTION I: SUMMARY

IP Facts

Overview

Product Specification

Designing with the Core

C-Model Reference

Introduction

The Xilinx LogiCORE™ IP RGB to YCrCb Color-Space Converter core is a simplified 3x3 matrix multiplier converting three input color samples to three output samples in a single clock cycle. The optimized structure uses only four XtremeDSP™ slices by taking advantage of the dependencies between coefficients in the conversion matrix of most RGB to YCrCb 4:4:4 or RGB to YUV 4:4:4 standards.

Features

- Built-in support for:
 - SD (ITU 601)
 - HD (ITU 709) PAL
 - HD (ITU 709) NTSC
 - YUV
- Support for user-defined conversion matrices
- AXI4-Stream data interfaces
- Optional AXI4-Lite control interface
- Supports 8, 10, 12 and 16-bit per color component input and output
- Built-in, optional bypass and test-pattern generator mode
- Built-in, optional throughput monitors
- Supports spatial resolutions from 32x32 up to 7680x7680
 - Supports 1080P60 in all supported device families ⁽¹⁾
 - Supports 4kx2k @ 24 Hz in supported high performance devices

1. Performance on low power devices may be lower.

LogiCORE IP Facts Table	
Core Specifics	
Supported Device Family ⁽¹⁾	Zynq-7000 ⁽²⁾ , Artix-7, Virtex®-7, Kintex®-7, Virtex-6, Spartan®-6
Supported User Interfaces	AXI4-Lite, AXI4-Stream ⁽³⁾
Resources	See Table 2-1 through Table 2-8 .
Provided with Core	
Documentation	Product Guide
Design Files	ISE: NGC netlist, Encrypted HDL Vivado: Encrypted RTL
Example Design	Not Provided
Test Bench	Verilog
Constraints File	Not Provided
Supported Software Drivers	Not Applicable
Simulation Models	VHDL or Verilog Structural, C-Model
Supported Software Drivers	Not Applicable
Tested Design Flows ⁽⁴⁾	
Design Entry Tools	Integrated Software Environment (ISE) 14.3, Vivado™ 2012.3 Design Suite ⁽⁶⁾ , Platform Studio (XPS)
Simulation ⁽⁵⁾	Mentor Graphics ModelSim, Xilinx® ISim
Synthesis Tools	Xilinx Synthesis Technology (XST) Vivado Synthesis
Support	
Provided by Xilinx, Inc.	

1. For a complete listing of supported devices, see the [release notes](#) for this core.
2. Supported in ISE Design Suite implementations only.
3. Video protocol as defined in the *Video IP: AXI Feature Adoption* section of UG761 AXI Reference Guide [\[Ref 1\]](#).
4. For the supported versions of the tools, see the [Xilinx Design Tools: Release Notes Guide](#).
5. For the supported versions of the tools, see the [ISE Design Suite 14: Release Notes Guide](#).
6. Supports only 7 series devices.

Overview

A color space is a mathematical representation of a set of colors. The most popular color models are:

- RGB or R'G'B', gamma corrected RGB, used in computer graphics
- YIQ, YUV and YCrCb used in video systems

These color spaces are directly related to the intuitive notions of hue, saturation and brightness.

All color spaces can be derived from the RGB information supplied by devices such as cameras and scanners. Different color spaces have historically evolved for different applications. In each case, a color space was chosen for application-specific reasons.

The convergence of computers, the Internet and a wide variety of video devices, all using different color representations, is forcing the digital designer today to convert between them. The objective is to have all inputs converted to a common color space before algorithms and processes are executed. Converters are useful for a number of markets, including image and video processing.

Feature Summary

The RGB to YCrCb Color-Space Converter core transforms RGB video data into YCrCb 4:4:4 or YUV 4:4:4 video data. The core supports four common format conversions as well as a custom mode that allows for a user-defined transform. The core is capable of a maximum resolution of 7680 columns by 7680 rows with 8, 10, 12, or 16 bits per pixel and supports the bandwidth necessary for High-definition (1080p60) resolutions in all Xilinx FPGA device families. Higher resolutions can be supported in Xilinx high-performance device families.

You can configure and instantiate the core from Integrated Software Environment (ISE), Vivado design tools, or EDK tools. Core functionality may be controlled dynamically with an optional AXI4-Lite interface.

Applications

- Post-processing core for image data
 - Video surveillance
 - Video conferencing
 - Machine vision
 - Other imaging applications
-

Licensing and Ordering Information

This Xilinx LogiCORE IP module is provided under the terms of the [Xilinx Core License Agreement](#). The module is shipped as part of the Vivado Design Suite and ISE Design Suite. For full access to all core functionalities in simulation and in hardware, you must purchase a license for the core. Contact your [local Xilinx sales representative](#) for information about pricing and availability.

For more information, visit the RGB to YCrCb Color-Space Converter product web page.

Product Specification

Standards

The RGB to YCrCb Color-Space Converter core is compliant with the AXI4-Stream Video Protocol and AXI4-Lite interconnect standards. Refer to the *Video IP: AXI Feature Adoption* section of the (UG761) *AXI Reference Guide* [Ref 1] for additional information.

Performance

The following sections detail the performance characteristics of the RGB to YCrCb Color-Space Converter core.

Maximum Frequencies

This section contains typical clock frequencies for the target devices. The maximum achievable clock frequency can vary. The maximum achievable clock frequency and all resource counts can be affected by other tool options, additional logic in the FPGA device, using a different version of Xilinx tools and other factors. Refer to in [Table 2-1](#) through [Table 2-8](#) for device-specific information.

Latency

The processing latency of the core is shown in the following equation:

$$\text{Latency} = 9 + 1(\text{if has clipping}) + 1(\text{if has clamping})$$

This code evaluates to 11 clock cycles for typical cases (unless in “custom” mode the clipping and/or clamping circuits are not used).

Throughput

The Color Space Converter core outputs one YCbCr 4:4:4 sample per clock cycle.

Resource Utilization

For an accurate measure of the usage of primitives, slices, and CLBs for a particular instance, check the **Display Core Viewer after Generation**.

Resource Utilization using ISE Tools

The information presented in [Table 2-1](#) through [Table 2-5](#) is a guide to the resource utilization and maximum clock frequency of this core for all input/output width combinations for Virtex-7, Kintex-7, Artix-7, Zynq-7000, Virtex-6, and Spartan-6 FPGA families. The Xtreme DSP Slice count is always 4, regardless of parameterization, and this core does not use any dedicated I/O or CLK resources. The design was tested using ISE[®] v14.3 tools with the AXI4-Lite interface, INTC_IF, and the Debug Features disabled.

Table 2-1: Kintex-7 (and Zynq-7000 Devices with Kintex Based Fabric)

Data Width	Slice FFs	Slice LUTs	LUT6-FF pairs	DSP48A1s	Clock Frequency (MHz)
8	279	343	374	4	304
10	329	380	417	4	296
12	379	417	464	4	312
16	479	512	569	4	274

1. Speedfile: XC7K70T-1 FBG484

Table 2-2: Artix-7 (and Zynq-7000 Devices with Artix Based Fabric)

Data Width	Slice FFs	Slice LUTs	LUT6-FF pairs	DSP48A1s	Clock Frequency (MHz)
8	279	279	360	4	204
10	329	329	403	4	212
12	379	379	447	4	204
16	479	479	557	4	212

1. Speedfile: XC7A100T-1 FF484

Table 2-3: Virtex-7

Data Width	Slice FFs	Slice LUTs	LUT6-FF pairs	DSP48A1s	Clock Frequency (MHz)
8	279	343	373	4	312
10	329	380	421	4	304

Table 2-3: Virtex-7 (Cont'd)

Data Width	Slice FFs	Slice LUTs	LUT6-FF pairs	DSP48A1s	Clock Frequency (MHz)
12	379	421	459	4	296
16	479	512	567	4	296

1. Speedfile: XC7VX585T-1 FFG1157

Table 2-4: Virtex-6

Data Width	Slice FFs	Slice LUTs	LUT6-FF pairs	DSP48A1s	Clock Frequency (MHz)
8	279	349	374	4	312
10	329	384	425	4	320
12	379	425	463	4	312
16	479	524	551	4	312

1. Speedfile: XC6VLX75T-1 FF484

Table 2-5: Spartan-6

Data Width	Slice FFs	Slice LUTs	LUT6-FF pairs	DSP48A1s	Clock Frequency (MHz)
8	286	321	343	4	180
10	335	358	392	4	180
12	386	394	421	4	172
16	513	450	521	4	118

1. Speedfile: XC6SLX25-2 FGG484

Resource Utilization using Vivado Tools

Table 2-6 through Table 2-8 were generated using Vivado 2012.3 tools with the AXI4-Lite interface, INTC_IF, and the Debug Features disabled.

Table 2-6: Kintex-7 (and Zynq-7000 Devices with Kintex Based Fabric)

Data Width	Slice FFs	Slice LUTs	LUT as Logic	LUT6-FF pairs	DSPs	Clock Frequency (MHz)
8	313	320	368	7	242	313
10	367	366	447	7	234	367

Table 2-6: Kintex-7 (and Zynq-7000 Devices with Kintex Based Fabric) (Cont'd)

Data Width	Slice FFs	Slice LUTs	LUT as Logic	LUT6-FF pairs	DSPs	Clock Frequency (MHz)
12	421	429	513	7	234	421
16	529	544	647	7	234	529

1. Speedfile: XC7K70T-1 FBG484

Table 2-7: Artix-7 (and Zynq-7000 Devices with Artix Based Fabric)

Data Width	Slice FFs	Slice LUTs	LUT as Logic	LUT6-FF pairs	DSPs	Clock Frequency (MHz)
8	313	318	370	7	180	313
10	367	367	425	7	180	367
12	421	429	497	7	180	421
16	529	543	645	7	196	529

2. Speedfile: XC7A100T-1 FF484

Table 2-8: Virtex-7

Data Width	Slice FFs	Slice LUTs	LUT as Logic	LUT6-FF pairs	DSPs	Clock Frequency (MHz)
8	313	321	372	7	242	313
10	367	366	432	7	234	367
12	421	428	510	7	242	421
16	529	545	633	7	234	529

1. Speedfile: XC7VX585T-1 FFG1157

Core Interfaces and Register Space

Port Descriptions

The RGB to YCrCb Color-Space Converter core uses industry standard control and data interfaces to connect to other system components. The following sections describe the various interfaces available with the core. Figure 2-1 illustrates an I/O diagram of the RGB2YCrCb core. Some signals are optional and not present for all configurations of the core. The AXI4-Lite interface and the IRQ pin are present only when the core is configured via the GUI with an AXI4-Lite control interface. The INTC_IF interface is present only when the core is configured via the GUI with the INTC interface enabled.

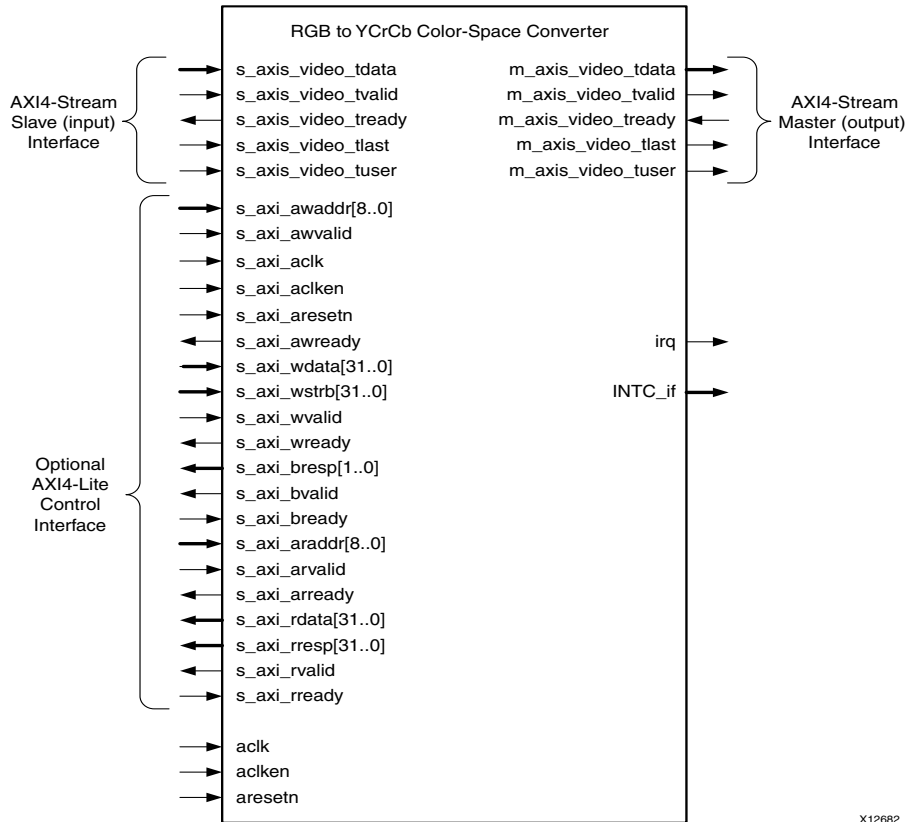

Figure 2-1: RGB2YCrCb Core Top-Level Signaling Interface

X12682

Common Interface Signals

Table 2-9 summarizes the signals which are either shared by, or not part of the dedicated AXI4-Stream data or AXI4-Lite control interfaces.

Table 2-9: Common Interface Signals

Signal Name	Direction	Width	Description
ACLK	In	1	Video Core Clock
ACLKEN	In	1	Video Core Active High Clock Enable
ARESETn	In	1	Video Core Active Low Synchronous Reset
INTC_IF	Out	6	Optional External Interrupt Controller Interface. Available only when INTC_IF is selected on GUI.
IRQ	Out	1	Optional Interrupt Request Pin. Available only when AXI4-Lite interface is selected on GUI.

The ACLK, ACLKEN and ARESETn signals are shared between the core and the AXI4-Stream data interfaces. The AXI4-Lite control interface has its own set of clock, clock enable and reset pins: S_AXI_ACLK, S_AXI_ACLKEN and S_AXI_ARESETn. Refer to [The Interrupt Subsystem](#) for a detailed description of the INTC_IF and IRQ pins.

ACLK

The AXI4-Stream interface must be synchronous to the core clock signal `ACLK`. All AXI4-Stream interface input signals are sampled on the rising edge of `ACLK`. All AXI4-Stream output signal changes occur after the rising edge of `ACLK`. The AXI4-Lite interface is unaffected by the `ACLK` signal.

ACLKEN

The `ACLKEN` pin is an active-high, synchronous clock-enable input pertaining to AXI4-Stream interfaces. Setting `ACLKEN` low (de-asserted) halts the operation of the core despite rising edges on the `ACLK` pin. Internal states are maintained, and output signal levels are held until `ACLKEN` is asserted again. When `ACLKEN` is de-asserted, core inputs are not sampled, except `ARESETn`, which supersedes `ACLKEN`. The AXI4-Lite interface is unaffected by the `ACLKEN` signal.

ARESETn

The `ARESETn` pin is an active-low, synchronous reset input pertaining to only AXI4-Stream interfaces. `ARESETn` supersedes `ACLKEN`, and when set to 0, the core resets at the next rising edge of `ACLK` even if `ACLKEN` is de-asserted. The `ARESETn` signal must be synchronous to the `ACLK` and must be held low for a minimum of 32 clock cycles of the slowest clock. The AXI4-Lite interface is unaffected by the `ARESETn` signal.

Data Interface

The RGB2YCrCb core receives and transmits data using AXI4-Stream interfaces that implement a video protocol as defined in the *Video IP: AXI Feature Adoption* section of the (UG761) *AXI Reference Guide* [Ref 1].

AXI4-Stream Signal Names and Descriptions

Table 2-10 describes the AXI4-Stream signal names and descriptions.

Table 2-10: AXI4-Stream Data Interface Signal Descriptions

Signal Name	Direction	Width	Description
<code>s_axis_video_tdata</code>	In	24,32,40,48	Input Video Data
<code>s_axis_video_tvalid</code>	In	1	Input Video Valid Signal
<code>s_axis_video_tready</code>	Out	1	Input Ready
<code>s_axis_video_tuser</code>	In	1	Input Video Start Of Frame
<code>s_axis_video_tlast</code>	In	1	Input Video End Of Line
<code>m_axis_video_tdata</code>	Out	24,32,40,48	Output Video Data
<code>m_axis_video_tvalid</code>	Out	1	Output Valid

Table 2-10: AXI4-Stream Data Interface Signal Descriptions (Cont'd)

Signal Name	Direction	Width	Description
m_axis_video_tready	In	1	Output Ready
m_axis_video_tuser	Out	1	Output Video Start Of Frame
m_axis_video_tlast	Out	1	Output Video End Of Line

Video Data

The AXI4-Stream interface specification restricts TDATA widths to integer multiples of 8 bits. Therefore, 10, 12, and 16 bit data must be padded with zeros on the MSB to form Nx8 bit wide vector before connecting to s_axis_video_tdata. Padding does not affect the size of the core.

For example, RGB data on the RGB2YCrCb input s_axis_video_tdata is packed and padded to multiples of 8 bits as necessary, as seen in Figure 2-2. Zero padding the most significant bits is only necessary for 10, 12, and 16 bit wide data.

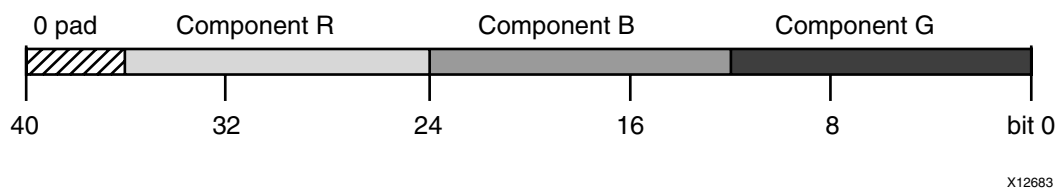

Figure 2-2: RGB Data Encoding on s_axis_video_tdata

Similarly, YCb data on the YCrCb2RGB output m_axis_video_tdata is packed and padded to multiples of 8 bits as necessary, as seen in Figure 2-3. Zero padding the most significant bits only necessary for 10,12 and 16 bits wide data.

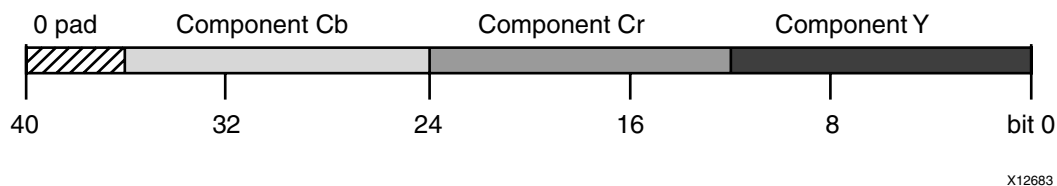

Figure 2-3: YCrCb Data Encoding on m_axis_video_tdata

READY/VALID Handshake

A valid transfer occurs whenever READY, VALID, ACLKEN, and ARESETn are high at the rising edge of ACLK, as seen in Figure 2-4. During valid transfers, DATA only carries active video data. Blank periods and ancillary data packets are not transferred via the AXI4-Stream video protocol.

Guidelines on Driving s_axis_video_tvalid

Once `s_axis_video_tvalid` is asserted, no interface signals (except the RGB2YCrCb core driving `s_axis_video_tready`) may change value until the transaction completes (`s_axis_video_tready`, and `s_axis_video_tvalid` `ACLKEN` are high on the rising edge of `ACLK`). Once asserted, `s_axis_video_tvalid` may only be de-asserted after a transaction has completed. Transactions may not be retracted or aborted. In any cycle following a transaction, `s_axis_video_tvalid` can either be de-asserted or remain asserted to initiate a new transfer.

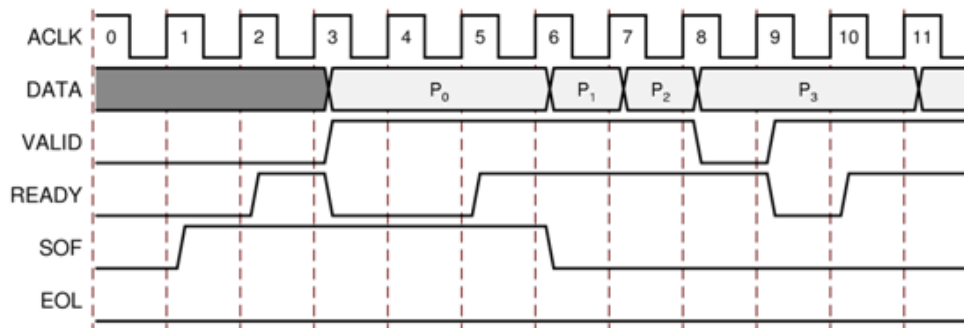

Figure 2-4: Example of READY/VALID Handshake, Start of a New Frame

Guidelines on Driving m_axis_video_tready

The `m_axis_video_tready` signal may be asserted before, during or after the cycle in which the RGB2YCrCb core asserted `m_axis_video_tvalid`. The assertion of `m_axis_video_tready` may be dependent on the value of `m_axis_video_tvalid`. A slave that can immediately accept data qualified by `m_axis_video_tvalid`, should pre-assert its `m_axis_video_tready` signal until data is received. Alternatively, `m_axis_video_tready` can be registered and driven the cycle following `VALID` assertion.



RECOMMENDED: *The AXI4-Stream slave should drive READY independently, or pre-assert READY to minimize latency.*

Start of Frame Signals - m_axis_video_tuser0, s_axis_video_tuser0

The Start-Of-Frame (SOF) signal, physically transmitted over the AXI4-Stream `TUSER0` signal, marks the first pixel of a video frame. The SOF pulse is 1 valid transaction wide, and must coincide with the first pixel of the frame, as seen in Figure 2-4. SOF serves as a frame synchronization signal, which allows downstream cores to re-initialize, and detect the first pixel of a frame. The SOF signal may be asserted an arbitrary number of `ACLK` cycles before the first pixel value is presented on `DATA`, as long as a `VALID` is not asserted.

End of Line Signals - `m_axis_video_tlast`, `s_axis_video_tlast`

The End-Of-Line signal, physically transmitted over the AXI4-Stream TLAST signal, marks the last pixel of a line. The EOL pulse is 1 valid transaction wide, and must coincide with the last pixel of a scan-line, as seen in Figure 2-5.

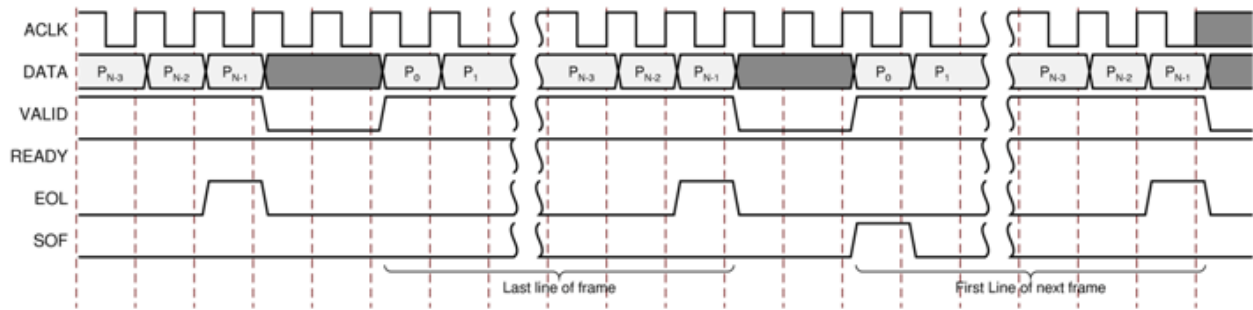

Figure 2-5: Use of EOL and SOF Signals

Control Interface

When configuring the core, the user has the option to add an AXI4-Lite register interface to dynamically control the behavior of the core. The AXI4-Lite slave interface facilitates integrating the core into a processor system, or along with other video or AXI4-Lite compliant IP, connected via AXI4-Lite interface to an AXI4-Lite master. In a static configuration with a fixed set of parameters (constant configuration), the core can be instantiated without the AXI4-Lite control interface, which reduces the core Slice footprint.

Constant Configuration

The constant configuration caters to designs that use the core in one setup that will not need to change over time. In constant configuration the image resolution (number of active pixels per scan line and the number of active scan lines per frame), and the other core parameters are hard coded into the core via the RGB2YCrCb core GUI. Since there is no AXI4-Lite interface, the core is not programmable, but can be reset, enabled, or disabled using the `ARESETn` and `ACLKEN` ports.

AXI4-Lite Interface

The AXI4-Lite interface allows a user to dynamically control parameters within the core. Core configuration can be accomplished using an AXI4-Stream master state machine, or an embedded ARM or soft system processor such as MicroBlaze.

The RGB2YCrCb core can be controlled via the AXI4-Lite interface using read and write transactions to the RGB2YCrCb register space.

Table 2-11: AXI4-Lite Interface Signals

Signal Name	Direction	Width	Description
s_axi_aclk	In	1	AXI4-Lite clock
s_axi_aclken	In	1	AXI4-Lite clock enable
s_axi_aresetn	In	1	AXI4-Lite synchronous Active Low reset
s_axi_awvalid	In	1	AXI4-Lite Write Address Channel Write Address Valid.
s_axi_awread	Out	1	AXI4-Lite Write Address Channel Write Address Ready. Indicates DMA ready to accept the write address.
s_axi_awaddr	In	32	AXI4-Lite Write Address Bus
s_axi_wvalid	In	1	AXI4-Lite Write Data Channel Write Data Valid.
s_axi_wready	Out	1	AXI4-Lite Write Data Channel Write Data Ready. Indicates DMA is ready to accept the write data.
s_axi_wdata	In	32	AXI4-Lite Write Data Bus
s_axi_bresp	Out	2	AXI4-Lite Write Response Channel. Indicates results of the write transfer.
s_axi_bvalid	Out	1	AXI4-Lite Write Response Channel Response Valid. Indicates response is valid.
s_axi_bready	In	1	AXI4-Lite Write Response Channel Ready. Indicates target is ready to receive response.
s_axi_arvalid	In	1	AXI4-Lite Read Address Channel Read Address Valid
s_axi_arready	Out	1	Ready. Indicates DMA is ready to accept the read address.
s_axi_araddr	In	32	AXI4-Lite Read Address Bus
s_axi_rvalid	Out	1	AXI4-Lite Read Data Channel Read Data Valid
s_axi_rready	In	1	AXI4-Lite Read Data Channel Read Data Ready. Indicates target is ready to accept the read data.
s_axi_rdata	Out	32	AXI4-Lite Read Data Bus
s_axi_rresp	Out	2	AXI4-Lite Read Response Channel Response. Indicates results of the read transfer.

S_AXI_ACLK

The AXI4-Lite interface must be synchronous to the S_AXI_ACLK clock signal. The AXI4-Lite interface input signals are sampled on the rising edge of ACLK. The AXI4-Lite output signal changes occur after the rising edge of ACLK. The AXI4-Stream interfaces signals are not affected by the S_AXI_ACLK.

S_AXI_ACLKEN

The S_AXI_ACLKEN pin is an active-high, synchronous clock-enable input for the AXI4-Lite interface. Setting S_AXI_ACLKEN low (de-asserted) halts the operation of the AXI4-Lite

interface despite rising edges on the `S_AXI_ACLK` pin. AXI4-Lite interface states are maintained, and AXI4-Lite interface output signal levels are held until `S_AXI_ACLKEN` is asserted again. When `S_AXI_ACLKEN` is de-asserted, AXI4-Lite interface inputs are not sampled, except `S_AXI_ARESETn`, which supersedes `S_AXI_ACLKEN`. The AXI4-Stream interfaces signals are not affected by the `S_AXI_ACLKEN`.

S_AXI_ARESETn

The `S_AXI_ARESETn` pin is an active-low, synchronous reset input for the AXI4-Lite interface. `S_AXI_ARESETn` supersedes `S_AXI_ACLKEN`, and when set to 0, the core resets at the next rising edge of `S_AXI_ACLK` even if `S_AXI_ACLKEN` is de-asserted. The `S_AXI_ARESETn` signal must be synchronous to the `S_AXI_ACLK` and must be held low for a minimum of 32 clock cycles of the slowest clock. The `S_AXI_ARESETn` input is resynchronized to the `ACLK` clock domain. The AXI4-Stream interfaces and core signals are also reset by `S_AXI_ARESETn`.

Register Space

The standardized Xilinx Video IP register space is partitioned to control-, timing-, and core specific registers. The RGB2YCrCb core uses only one timing related register, `ACTIVE_SIZE` (0x0020), which allows specifying the input frame dimensions. The core has thirteen core specific registers which allow the user to dynamically control the operation of the core.

Table 2-12: Register Names and Descriptions

Address (hex) BASEADDR +	Register Name	Access Type	Double Buffered	Default Value	Register Description
0x0000	CONTROL	R/W	N	Power-on-Reset : 0x0	Bit 0: SW_ENABLE Bit 1: REG_UPDATE Bit 4: BYPASS ⁽¹⁾ Bit 5: TEST_PATTERN ⁽¹⁾ Bit 30: FRAME_SYNC_RESET (1: reset) Bit 31: SW_RESET (1: reset)
0x0004	STATUS	R/W	No	0	Bit 0: PROC_STARTED Bit 1: EOF Bit 16: SLAVE_ERROR
0x0008	ERROR	R/W	No	0	Bit 0: SLAVE_EOL_EARLY Bit 1: SLAVE_EOL_LATE Bit 2: SLAVE_SOF_EARLY Bit 3: SLAVE_SOF_LATE
0x000C	IRQ_ENABLE	R/W	No	0	16-0: Interrupt enable bits corresponding to STATUS bits

Table 2-12: Register Names and Descriptions (Cont'd)

Address (hex) BASEADDR +	Register Name	Access Type	Double Buffered	Default Value	Register Description
0x0010	VERSION	R	N/A	0x0601a000	7-0: REVISION_NUMBER 11-8: PATCH_ID 15-12: VERSION_REVISION 23-16: VERSION_MINOR 31-24: VERSION_MAJOR
0x0014	SYSDEBUG0	R	N/A	0	0-31: Frame Throughput monitor ⁽¹⁾
0x0018	SYSDEBUG1	R	N/A	0	0-31: Line Throughput monitor ⁽¹⁾
0x001C	SYSDEBUG2	R	N/A	0	0-31: Pixel Throughput monitor ⁽¹⁾
0x0020	ACTIVE_SIZE	R/W	Yes	Specified via GUI	12-0: Number of Active Pixels per Scanline 28-16: Number of Active Lines per Frame
0x0100	YMAX	R/W	Yes	Specified via GUI	15:0: Luma clipping value
0x0104	YMIN	R/W	Yes	Specified via GUI	15:0: Luma clamping value
0x0108	CbMAX	R/W	Yes	Specified via GUI	15:0: Chroma Cb clipping value
0x010C	CbMIN	R/W	Yes	Specified via GUI	15:0: Chroma Cb clamping value
0x0110	CrMAX	R/W	Yes	Specified via GUI	15:0: Chroma Cr clipping value
0x0114	CrMIN	R/W	Yes	Specified via GUI	15:0: Chroma Cr clamping value
0x0118	YOFFSET	R/W	Yes	Specified via GUI	16:0: Luma offset compensation
0x011C	CbOFFSET	R/W	Yes	Specified via GUI	16:0: Chroma (Cb) offset compensation
0x0120	CrOFFSET	R/W	Yes	Specified via GUI	16:0: Chroma (Cr) offset compensation
0x0124	ACOEf	R/W	Yes	Specified via GUI	17:0: ACOEF, BCOEF, CCOEF, DCOEF are derived from CA, CB, CC and CD, by representing the floating point coefficients in 17-bit wide signed integer format.
0x0128	BCOEF	R/W	Yes	Specified via GUI	
0x012C	CCOEF	R/W	Yes	Specified via GUI	
0x0130	DCOEF	R/W	Yes	Specified via GUI	

1. Only available when the debugging features option is enabled in the GUI at the time the core is instantiated.

CONTROL (0x0000) Register

Bit 0 of the CONTROL register, SW_ENABLE, facilitates enabling and disabling the core from software. Writing '0' to this bit effectively disables the core halting further operations, which blocks the propagation of all video signals. After Power up, or Global Reset, the SW_ENABLE defaults to 0 for the AXI4-Lite interface. Similar to the ACLKEN pin, the SW_ENABLE flag is not synchronized with the AXI4-Stream interfaces: Enabling or Disabling the core takes effect immediately, irrespective of the core processing status. Disabling the core for extended periods may lead to image tearing.

Bit 1 of the `CONTROL` register, `REG_UPDATE` is a write done semaphore for the host processor, which facilitates committing all user and timing register updates simultaneously. The RGB2YCrCb core `ACTIVE_SIZE` and core specific registers are double buffered. One set of registers (the processor registers) is directly accessed by the processor interface, while the other set (the active set) is actively used by the core. New values written to the processor registers will get copied over to the active set at the end of the AXI4-Stream frame, if and only if `REG_UPDATE` is set. Setting `REG_UPDATE` to 0 before updating multiple register values, then setting `REG_UPDATE` to 1 when updates are completed ensures all registers are updated simultaneously at the frame boundary without causing image tearing.

Bit 4 of the `CONTROL` register, `BYPASS`, switches the core to bypass mode if debug features are enabled. In bypass mode the RGB2YCrCb core processing function is bypassed, and the core repeats AXI4-Stream input samples on its output. Refer to [Debugging Features in Appendix C](#) for more information. If debug features were not included at instantiation, this flag has no effect on the operation of the core. Switching bypass mode on or off is not synchronized to frame processing, therefore can lead to image tearing.

Bit 5 of the `CONTROL` register, `TEST_PATTERN`, switches the core to test-pattern generator mode if debug features are enabled. Refer to [Debugging Features in Appendix C](#) for more information. If debug features were not included at instantiation, this flag has no effect on the operation of the core. Switching test-pattern generator mode on or off is not synchronized to frame processing, therefore can lead to image tearing.

Bits 30 and 31 of the `CONTROL` register, `FRAME_SYNC_RESET` and `SW_RESET` facilitate software reset. Setting `SW_RESET` reinitializes the core to GUI default values, all internal registers and outputs are cleared and held at initial values until `SW_RESET` is set to 0. The `SW_RESET` flag is not synchronized with the AXI4-Stream interfaces. Resetting the core while frame processing is in progress will cause image tearing. For applications where the soft-ware reset functionality is desirable, but image tearing has to be avoided a frame synchronized software reset (`FRAME_SYNC_RESET`) is available. Setting `FRAME_SYNC_RESET` to 1 will reset the core at the end of the frame being processed, or immediately if the core is between frames when the `FRAME_SYNC_RESET` was asserted. After reset, the `FRAME_SYNC_RESET` bit is automatically cleared, so the core can get ready to process the next frame of video as soon as possible. The default value of both `RESET` bits is 0. Core instances with no AXI4-Lite control interface can only be reset via the `ARESETn` pin.

STATUS (0x0004) Register

All bits of the `STATUS` register can be used to request an interrupt from the host processor. To facilitate identification of the interrupt source, bits of the `STATUS` register remain set after an event associated with the particular `STATUS` register bit, even if the event condition is not present at the time the interrupt is serviced.

Bits of the `STATUS` register can be cleared individually by writing '1' to the bit position.

Bit 0 of the `STATUS` register, `PROC_STARTED`, indicates that processing of a frame has commenced via the AXI4-Stream interface.

Bit 1 of the `STATUS` register, End-of-frame (EOF), indicates that the processing of a frame has completed.

Bit 16 of the `STATUS` register, `SLAVE_ERROR`, indicates that one of the conditions monitored by the `ERROR` register has occurred.

ERROR (0x0008) Register

Bit 16 of the `STATUS` register, `SLAVE_ERROR`, indicates that one of the conditions monitored by the `ERROR` register has occurred. This bit can be used to request an interrupt from the host processor. To facilitate identification of the interrupt source, bits of the `STATUS` and `ERROR` registers remain set after an event associated with the particular `ERROR` register bit, even if the event condition is not present at the time the interrupt is serviced.

Bits of the `ERROR` register can be cleared individually by writing '1' to the bit position to be cleared.

Bit 0 of the `ERROR` register, `EOL_EARLY`, indicates an error during processing a video frame via the AXI4-Stream slave port. The number of pixels received between the latest and the preceding End-Of-Line (EOL) signal was less than the value programmed into the `ACTIVE_SIZE` register.

Bit 1 of the `ERROR` register, `EOL_LATE`, indicates an error during processing a video frame via the AXI4-Stream slave port. The number of pixels received between the last EOL signal surpassed the value programmed into the `ACTIVE_SIZE` register.

Bit 2 of the `ERROR` register, `SOF_EARLY`, indicates an error during processing a video frame via the AXI4-Stream slave port. The number of pixels received between the latest and the preceding Start-Of-Frame (SOF) signal was less than the value programmed into the `ACTIVE_SIZE` register.

Bit 3 of the `ERROR` register, `SOF_LATE`, indicates an error during processing a video frame via the AXI4-Stream slave port. The number of pixels received between the last SOF signal surpassed the value programmed into the `ACTIVE_SIZE` register.

IRQ_ENABLE (0x000C) Register

Any bits of the `STATUS` register can generate a host-processor interrupt request via the `IRQ` pin. The Interrupt Enable register facilitates selecting which bits of `STATUS` register will assert `IRQ`. Bits of the `STATUS` registers are masked by (AND) corresponding bits of the `IRQ_ENABLE` register and the resulting terms are combined (OR) together to generate `IRQ`.

Version (0x0010) Register

Bit fields of the Version Register facilitate software identification of the exact version of the hardware peripheral incorporated into a system. The core driver can take advantage of this Read-Only value to verify that the software is matched to the correct version of the hardware. See [Table 2-12](#) for details.

SYSDEBUG0 (0x0014) Register

The `SYSDEBUG0`, or Frame Throughput Monitor, register indicates the number of frames processed since power-up or the last time the core was reset. The `SYSDEBUG` registers can be useful to identify external memory / Frame buffer / or throughput bottlenecks in a video system. Refer to [Debugging Features in Appendix C](#) for more information.

SYSDEBUG1 (0x0018) Register

The `SYSDEBUG1`, or Line Throughput Monitor, register indicates the number of lines processed since power-up or the last time the core was reset. The `SYSDEBUG` registers can be useful to identify external memory / Frame buffer / or throughput bottlenecks in a video system. Refer to [Debugging Features in Appendix C](#) for more information.

SYSDEBUG2 (0x001C) Register

The `SYSDEBUG2`, or Pixel Throughput Monitor, register indicates the number of pixels processed since power-up or the last time the core was reset. The `SYSDEBUG` registers can be useful to identify external memory / Frame buffer / or throughput bottlenecks in a video system. Refer to [Debugging Features in Appendix C](#) for more information.

ACTIVE_SIZE (0x0020) Register

The `ACTIVE_SIZE` register encodes the number of active pixels per scan line and the number of active scan lines per frame. The lower half-word (bits 12:0) encodes the number of active pixels per scan line. Supported values are between 32 and the value provided in the **Maximum number of pixels per scan line** field in the GUI. The upper half-word (bits 28:16) encodes the number of active scan lines per frame. Supported values are 32 to 7680. To avoid processing errors, the user should restrict values written to `ACTIVE_SIZE` to the range supported by the core instance.

YMAX (0x0100) Register

The `YMAX` register holds the maximum value allowed on the Luma (Y) channel of the output. If the output data is greater than this value, then this value replaces it on the output. This register is only valid if **Outputs Clipped** is selected in the core parameterization GUI.

YMIN (0x0104) Register

The YMin register holds the minimum value allowed on the Luma (Y) channel of the output. If the output data is less than this value, then this value replaces it on the output. This register is only valid if **Output Clamped** is selected in the core parameterization GUI.

CbMax (0x0108) Register

The CbMAX register holds the maximum value allowed on the Cb Chroma channel of the output. If the output data is greater than this value, then this value replaces it on the output. This register is only valid if **Outputs Clipped** is selected in the core parameterization GUI.

CbMin (0x010C) Register

The CbMin register holds the minimum value allowed on the Cb Chroma channel of the output. If the output data is less than this value, then this value replaces it on the output. This register is only valid if **Output Clamped** is selected in the core parameterization GUI.

CrMax (0x0110) Register

The CrMAX register holds the maximum value allowed on the Cr Chroma channel of the output. If the output data is greater than this value, then this value replaces it on the output. This register is only valid if **Outputs Clipped** is selected in the core parameterization GUI.

CrMin (0x0114) Register

The CrMin register holds the minimum value allowed on the Cr Chroma channel of the output. If the output data is less than this value, then this value replaces it on the output. This register is only valid if **Output Clamped** is selected in the core parameterization GUI.

YOFFSET (0x0118) Register

The YOFFSET register holds the offset compensation value for the Luma (Y) channel. The value should be limited by the size of the output. If the output is selected to be 10-bits then the Y offset should be in the range of 0 to 1023.

CbOffset (0x011C) Register

The CbOFFSET register holds the offset compensation value for the Cb Chroma channel. The value should be limited by the size of the output. If the output is selected to be 10-bits then the Cb offset should be in the range of 0 to 1023.

CrOffset (0x0120) Register

The CrOFFSET register holds the offset compensation value for the Cr Chroma channel. The value should be limited by the size of the output. If the output is selected to be 10-bits then the Cr offset should be in the range of 0 to 1023.

ACOE (0x0124) Register

The ACOEF register holds the CA coefficient expressed as an 18.16 floating point number. Multiply the CA floating point value by 65537 and round to the nearest integer.

BCOE (0x0128) Register

The BCOEF register holds the CB coefficient expressed as an 18.16 floating point number. Multiply the CB floating point value by 65537 and round to the nearest integer.

CCOE (0x012C) Register

The CCOEF register holds the CC coefficient expressed as an 18.16 floating point number. Multiply the CC floating point value by 65537 and round to the nearest integer.

DCOE (0x0130) Register

The DCOEF register holds the CD coefficient expressed as an 18.16 floating point number. Multiply the CD floating point value by 65537 and round to the nearest integer.

The Interrupt Subsystem

STATUS register bits can trigger interrupts so embedded application developers can quickly identify faulty interfaces or incorrectly parameterized cores in a video system. Irrespective of whether the AXI4-Lite control interface is present or not, the RGB2YCrCb core detects AXI4-Stream framing errors, as well as the beginning and the end of frame processing.

When the core is instantiated with an AXI4-Lite Control interface, the optional interrupt request pin (IRQ) is present. Events associated with bits of the STATUS register can generate a (level triggered) interrupt, if the corresponding bits of the interrupt enable register (IRQ_ENABLE) are set. Once set by the corresponding event, bits of the STATUS register stay set until the user application clears them by writing '1' to the desired bit positions. Using this mechanism the system processor can identify and clear the interrupt source.

Without the AXI4-Lite interface the user can still benefit from the core signaling error and status events. By selecting the **Enable INTC Port** check-box on the GUI, the core generates the optional INTC_IF port. This vector of signals gives parallel access to the individual interrupt sources, as seen in [Table 2-13](#).

Unlike `STATUS` and `ERROR` flags, `INTC_IF` signals are not held, rather stay asserted only while the corresponding event persists.

Table 2-13: INTC_IF Signal Functions

INTC_IF signal	Function
0	Frame processing start
1	Frame processing complete
2	Reserved
3	Reserved
4	Video over AXI4-Stream Error
5	EOL Early
6	EOL Late
7	SOF Early
8	SOF Late

In a system integration tool, such as EDK, the interrupt controller INTC IP can be used to register the selected `INTC_IF` signals as edge triggered interrupt sources. The INTC IP provides functionality to mask (enable or disable), as well as identify individual interrupt sources from software. Alternatively, for an external processor or MCU the user can custom build a priority interrupt controller to aggregate interrupt requests and identify interrupt sources.

Designing with the Core

General Design Guidelines

The RGB to YCrCb core converts RGB video into YCrCb 4:4:4 or YUV 4:4:4 video. The core processes samples provided via an AXI4-Stream Video protocol slave interface, outputs pixels via an AXI4-Stream Video protocol master interface, and can be controlled via an optional AXI4-Lite interface. The RGB2YCrCb block cannot change the input/output image sizes, the input and output pixel clock rates, or the frame rate. It is recommended that the RGB2YCrCb core is used in conjunction with the Video In to AXI4-Stream and Video Timing Controller cores. The Video Timing Controller core measures the timing parameters, such as number of active scan lines, number of active pixels per scan line of the image sensor. The Video In to AXI4-Stream core converts a standard parallel clocked video interface with syncs and or blanks to AXI4-Stream Video protocol as defined in the *Video IP: AXI Feature Adoption* section of the (UG761) *AXI Reference Guide* [Ref 1].

Typically, the RGB2YCrCb core is part of larger video system such as an Image Sensor Pipeline (ISP) System shown in Figure 3-1.

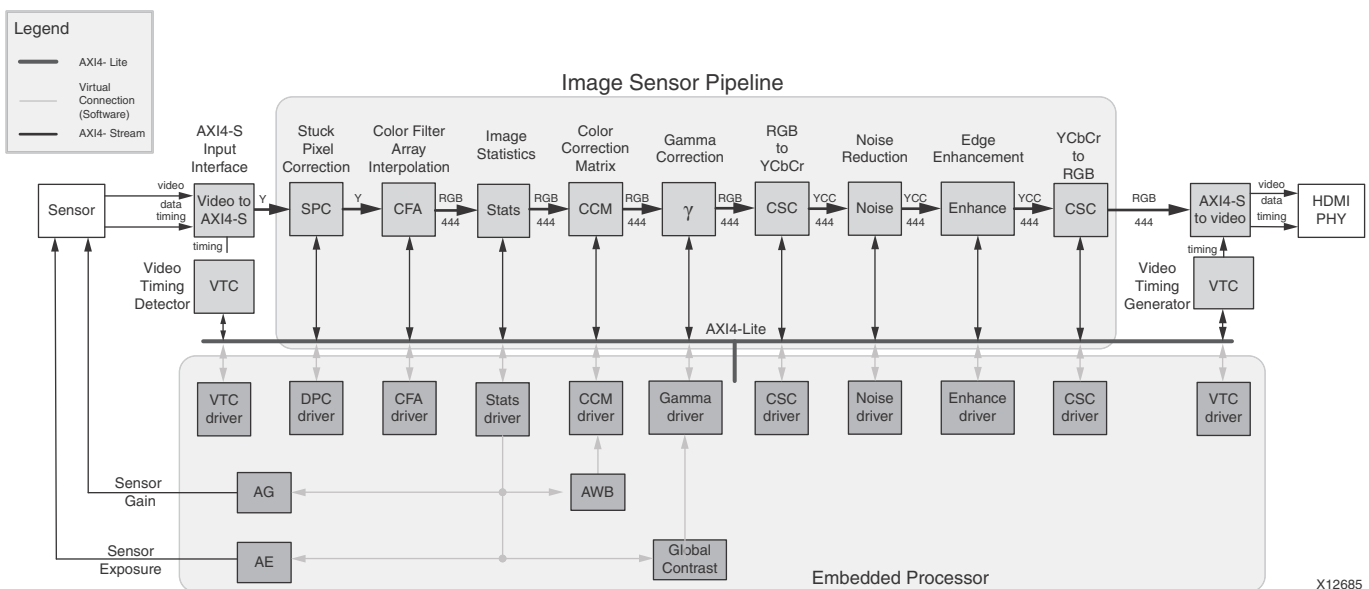

Figure 3-1: Image Sensor Pipeline System with RGB2YCrCb Core

X12685

Color-Space Conversion Background

The RGB Color Space

The red, green and blue (RGB) color space is widely used throughout computer graphics. Red, green and blue are three primary additive colors: individual components are added together to form a desired color, and are represented by a three dimensional, Cartesian coordinate system, as shown in [Figure 3-2](#).

[Table 3-1](#) presents the RGB values for 100% saturated color bars, a common video test signal.

Table 3-1: 100% RGB Color Bars

	Normal Range	White	Yellow	Cyan	Green	Magenta	Red	Blue	Black
R	0 to 255	255	255	0	0	255	255	0	0
G	0 to 255	255	255	255	255	0	0	0	0
B	0 to 255	255	0	255	0	255	0	255	0

The RGB color space is the most prevalent choice for computer graphics because color displays use red, green and blue to create the desired color. Also, a system that is designed using the RGB color space can take advantage of a large number of existing software algorithms.

However, RGB is not very efficient when dealing with real-world images. All three components need equal bandwidth to generate arbitrary colors within the RGB color cube. Also, processing an image in the RGB color space is usually not the most efficient method. For example, to modify the intensity or color of a given pixel, all three RGB values must be read, modified and written back to the frame buffer. If the system had access to the image stored in the intensity and color format, the process would be faster.

R'G'B' Color Space

While the RGB color space is ideal to represent computer graphics, 8-bit linear-light coding performs poorly for images to be viewed. It is necessary to have 12 or 14 bits per component to achieve excellent quality. The best perceptual use of a limited number of bits is made by using nonlinear coding that mimics the nonlinear response of human vision. In video, JPEG, MPEG, computing, digital photography, and many other domains, a nonlinear transfer function is applied to the RGB signals to give nonlinearly coded gamma-corrected components, denoted with symbols R'G'B'. Excellent image quality can be obtained with 10-bit nonlinear coding with a transfer function similar to that of *Rec. 709* or RGB.

YUV Color Space

The YUV color space is used by the analog PAL, NTSC and SECAM color video/TV standards. In the past, black and white systems used only the luminance (Y) information. Chrominance information (U and V) was added in such a way that a black and white receiver can still display a normal black and white picture.

YCrCb (or YCbCr) Color Space

The YCrCb or YCbCr color space was developed as part of the *ITU-R BT.601* during the development of a world-wide digital component video standard. YCbCr is a scaled, offset version of the YUV color space. Y has a nominal range of 16-235; Cb and Cr have a nominal range of 16-240. There are several YCbCr sampling formats, such as 4:4:4, 4:2:2 and 4:2:0.

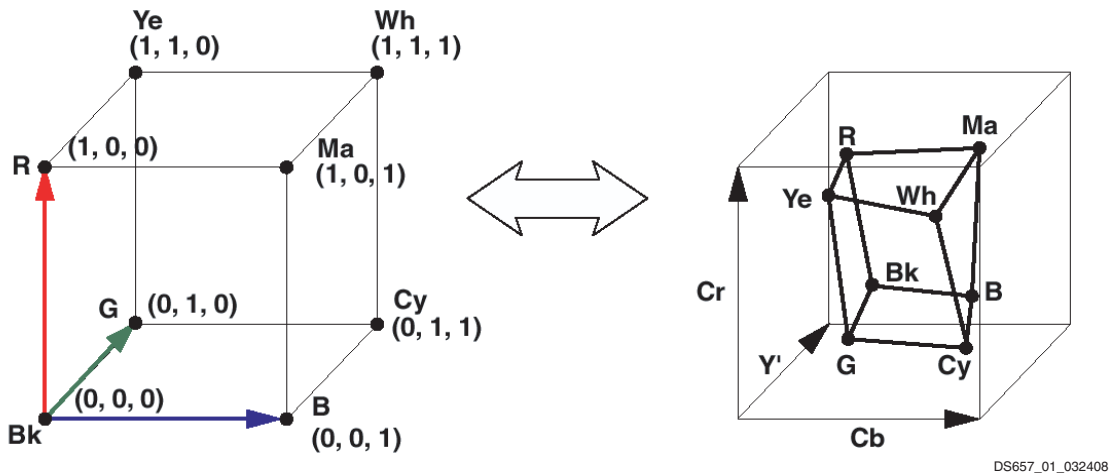

Figure 3-2: RGB and YCrCb Color Representations

DS657_01_032408

Conversion Equations

Derivation of Conversion Equations

To generate the luminance (Y, or gray value) component, biometric experiments were employed to measure how the human eye perceives the intensities of the red, green and blue colors. Based on these experiments, optimal values for coefficients CA and CB were determined, such that:

$$Y = CA * R + (1 - CA - CB) * G + CB * B \tag{Equation 3-1}$$

Actual values for CA and CB differ slightly in different standards.

Conversion from the RGB color space to luminance and chrominance (differential color components) could be described with [Equation 3-2](#).

$$\begin{bmatrix} Y \\ R-Y \\ B-Y \end{bmatrix} = \begin{bmatrix} CA & 1-CA-CB & CB \\ 1-CA & CA+CB-1 & -CB \\ -CA & CA+CB-1 & 1-CB \end{bmatrix} \begin{bmatrix} R \\ G \\ B \end{bmatrix} \quad \text{Equation 3-2}$$

Coefficients CA and CB are chosen between 0 and 1, which guarantees that the range of Y is constrained between the maximum and minimum RGB values permitted, RGB_{max} and RGB_{min} respectively.

The minimum and maximum values of R-Y are:

$$\min_{R-Y} = RGB_{min} - (CA \cdot RGB_{min} + (1-CA-CB) \cdot RGB_{max} + CB \cdot RGB_{max}) = (CA-1) \cdot (RGB_{max} - RGB_{min})$$

$$\max_{R-Y} = RGB_{max} - (CA \cdot RGB_{max} + (1-CA-CB) \cdot RGB_{min} + CB \cdot RGB_{min}) = (1-CA) \cdot (RGB_{max} - RGB_{min})$$

Thus, the range of R-Y is:

$$2(CA-1)(RGB_{max} - RGB_{min}) \quad \text{Equation 3-3}$$

Similarly, the minimum and maximum values of B-Y are:

$$\min_{B-Y} = RGB_{min} - (CA \cdot RGB_{max} + (1-CA-CB) \cdot RGB_{max} + CB \cdot RGB_{min}) = (CB-1)(RGB_{max} - RGB_{min})$$

$$\max_{B-Y} = RGB_{max} - (CA \cdot RGB_{min} + (1-CA-CB) \cdot RGB_{min} + CB \cdot RGB_{max}) = (1-CB)(RGB_{max} - RGB_{min})$$

Thus, the range of B-Y is:

$$2(CB-1)(RGB_{max} - RGB_{min}) \quad \text{Equation 3-4}$$

In most practical implementations, the range of the luminance and chrominance components should be equal. There are two ways to accomplish this: chrominance components (B-Y and R-Y) can be normalized (compressed and offset compensated), or values above and below the luminance range can be clipped.

Both clipping and dynamic range compression result in loss of information; however, the introduced artifacts are different. To leverage differences in the input (RGB) range, different standards choose different trade-offs between clipping and normalization.

The RGB to YCrCb color space conversion core facilitates both range compression and optional clipping and clamping. Range, offset, clipping and clamping levels are parameterizable. The core supports conversions that fit the following general form:

$$\begin{bmatrix} Y \\ C_R \\ C_B \end{bmatrix} = \begin{bmatrix} CA & 1-CA-CB & CB \\ CC(1-CA) & CC(CA+CB-1) & CC(-CB) \\ CD(-CA) & CD(CA+CB-1) & CD(1-CB) \end{bmatrix} \begin{bmatrix} R \\ G \\ B \end{bmatrix} + \begin{bmatrix} O_Y \\ O_{C_r} \\ O_{C_b} \end{bmatrix} \quad \text{Equation 3-5}$$

CC and CD allow dynamic range compression for R-Y and B-Y, and constants O_Y , O_{C_r} and O_{C_b} facilitate offset compensation for the resulting Y, C_B and C_R components.

Based on Equation 3-3 and Equation 3-4, to constrain the resulting chrominance components (C_B and C_R) into the [0,1] range, the chrominance offset (O_{Cr} and O_{Cb}) and the chrominance range compression constants (CC, CD) should be selected as follows ($O_{Cr/Cb} = 0.5$):

$$CC = \frac{1}{2(1 - CA)(RGB_{max} - RGB_{min})} \quad \text{Equation 3-6}$$

$$CD = \frac{1}{2(1 - CB)(RGB_{max} - RGB_{min})} \quad \text{Equation 3-7}$$

When RGB values are also in the [0,1] range, using the following equations avoids arithmetic under- and overflows ($O_{Cr/Cb} = 0.5$).

$$CC = \frac{1}{2(1 - CA)} \quad CD = \frac{1}{2(1 - CB)} \quad \text{Equation 3-8}$$

ITU 601 (SD) and 709 - 1125/60 (NTSC) Standard Conversion Coefficients

Table 3-2: Parameterization Values for the SD (ITU 601) and NTSC HD (ITU 709) Standards

Coefficient/ Parameter	Range		
	16-240	16-235	0-255
CA	0.299		0.2568
CB	0.114		0.0979
CC	0.713	0.7295	0.5910
CD	0.564	0.5772	
YOFFSET	$2^{Data_Width-4}$		
Cb/CrOFFSET	$2^{Data_width-1}$		
YMAX	$240 * 2^{Data_Width-8}$	$235 * 2^{Data_Width-8}$	$2^{OWIDTH-1}$
Cb/CrMAX	$240 * 2^{Data_Width-8}$	$235 * 2^{Data_Width-8}$	$2^{OWIDTH-1}$
YMIN	$16 * 2^{Data_Width-8}$		0
Cb/CrMIN	$16 * 2^{Data_Width-8}$		0

Standard ITU 709 (HD) 1250/50 (PAL)

Table 3-3: Parameterization Values for the PAL HD (ITU 709) Standard

Coefficient/ Parameter	Range		
	16-240	16-235	0-255
CA	0.2126		0.1819
CB	0.0722		0.0618
CC	0.6350	0.6495	0.6495
CD	0.5389	0.5512	
YOFFSET	$2^{Data_Width-4}$		
Cb/CrOFFSET	$2^{Data_Width-1}$		
YMAX	$240 * 2^{Data_Width-8}$	$235 * 2^{Data_Width-8}$	$2^{Data_Width-1}$
Cb/CrMAX	$240 * 2^{Data_Width-8}$	$235 * 2^{Data_Width-8}$	$2^{Data_Width-1}$
YMIN	$16 * 2^{Data_Width-8}$		0
Cb/CrMIN	$16 * 2^{Data_Width-8}$		0

YUV Standard

Table 3-4: Parameterization Values for the YUV Standard

Coefficient/ Parameter	Value		
	16-240	16-235	0-255
CA	0.299		
CB	0.114		
CC	0.877283		
CD	0.492111		
YOFFSET	$2^{Data_Width-4}$		
Cb/CrOFFSET	$2^{Data_Width-1}$		
YMAX	$240 * 2^{Data_Width-8}$	$235 * 2^{Data_Width-8}$	$2^{Data_Width-1}$
Cb/CrMAX	$240 * 2^{Data_Width-8}$	$235 * 2^{Data_Width-8}$	$2^{Data_Width-1}$
YMIN	$16 * 2^{Data_Width-8}$		0
Cb/CrMIN	$16 * 2^{Data_Width-8}$		0

Hardware Implementation

The RGB to YCrCb color space transformation equations (Equation 3-5) can be expressed as:

$$Y' = CA*(R - G) + G + CB*(B - G) \tag{Equation 3-9}$$

$$Y = Y' + YOFFSET \tag{Equation 3-10}$$

$$Cr = CC*(R - Y') + CrOFFSET \tag{Equation 3-11}$$

$$Cb = CD*(B - Y') + CbOFFSET \tag{Equation 3-12}$$

These equations can be directly mapped to the architecture shown in Figure 3-3. The blue boxes in Figure 3-3 represent logic blocks, which are always implemented using XtremeDSP slices.

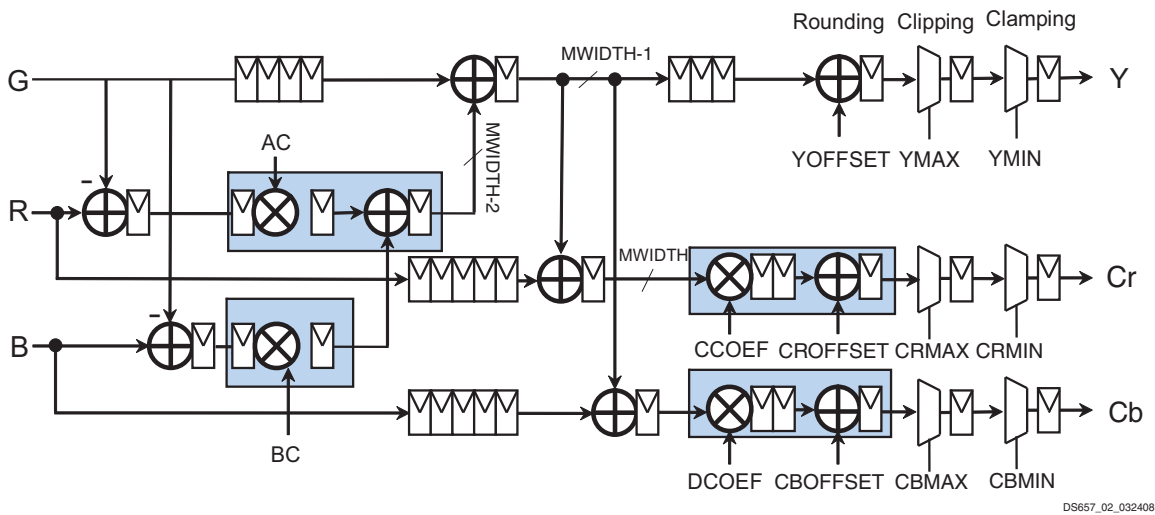

Figure 3-3: Application Schematic

Error Analysis

The following analysis, based on DSP fundamentals, presents mean-square-error (MSE) calculations for RGB to YCrCb, assuming *IWIDTH* bit RGB input data, *OWIDTH* bit wide YCrCb output data, and 17 bits for coefficient precision. [Ref 7] arrives to similar results for fixed coefficient values and input and output representations.

Taking rounding/quantization into account, the structure illustrated on Figure 3-3 implements the following equations:

$$Y_{RAW} = [ACOE\!F \cdot (R - G) + BCOE\!F \cdot (B - G)]_{MWIDTH-2} + G \quad \text{Equation 3-13}$$

$$Y = [Y_{RAW}]_{OWIDTH} + YOFF\!SET \quad \text{Equation 3-14}$$

$$Cb = [CCOE\!F \cdot (B - Y_{RAW})]_{OWIDTH} + CbOFF\!SET \quad \text{Equation 3-15}$$

$$Cr = [DCOE\!F \cdot (R - Y_{RAW})]_{OWIDTH} + CrOFF\!SET \quad \text{Equation 3-16}$$

where $[]_k$ denotes rounding to k bits. The architecture contains three possible operators that might introduce noise. Quantization noise is inserted when data is rounded.

1. Data is rounded to $MWIDTH-2$ bits after calculating Y_{raw} .
2. Data is rounded to $OWIDTH$ bits at the output.
3. If $CCOE\!F$ and $DCOE\!F$ are chosen such that Cb and Cr may over- or underflow, clipping noise gets inserted to the signal flow.

Before analyzing the effects of these noise sources, first look at the input Signal to Quantization Noise Ratio (SQNR). Assuming uniformly distributed quantization error,

$$SQNR_{RGB} = 10\log \frac{P_x}{P_N} = 10\log \frac{\int_{RGBMIN}^{RGBMAX} x^2 dx}{\frac{1}{\Delta} \int_{-\Delta/2}^{\Delta/2} e^2 dx} \quad \text{Equation 3-17}$$

Substituting $LSB = 2^{-INBITS}$, where $INBITS$ is the input (RGB) precision, $SQNR_{RGB}$ becomes a function of the input dynamic range. In the next three calculations, when calculating $SQNR_{RGB}$ for the typical dynamic ranges, $INBITS = 8$ for all three cases.

When RGB values are in the (0, 255) range:

$$SQNR_{RGB} = 10\log \frac{\frac{1}{255} \int_0^{255} x^2 dx}{\int_{-1/2}^{1/2} x^2 dx} = 10\log \frac{\frac{1}{3 \cdot 255} [255^3]}{\frac{1}{12}} = 54.15dB \quad \text{Equation 3-18}$$

when RGB values are in the (16, 240) range:

$$SQNR_{RGB} = 10\log \frac{\frac{1}{224} \int_{16}^{240} x^2 dx}{\int_{-1/2}^{1/2} x^2 dx} = 53.92dB \quad \text{Equation 3-19}$$

and when RGB values are in the (16, 235) range:

$$SQNR_{RGB} = 10\log \frac{\frac{1}{219} \int_{16}^{235} x^2 dx}{\int_{(-1)/2}^{1/2} x^2 dx} = 53.74dB \quad \text{Equation 3-20}$$

The first rounding noise source can be practically eliminated by the careful choice of *MWIDTH*. Approximating SQNR by $6.02 \text{ } MWIDTH$ [dB], intuitively the rounding noise can be reduced by increasing *MWIDTH*. However, *MWIDTH* affects the resource usage and carry chain length in the design (thereby affecting maximum speed). Choosing *MWIDTH* > 18 would significantly increase the dedicated multiplier count of the design.

Therefore, optimal *MWIDTH* values, in the *IWIDTH*+4 to 18 range, do not significantly increase resource counts but assure that quantization noise inserted is negligible (at least 20 dB less than the input noise).

Output Quantization Noise

Coefficients CC and CD in [Equation 3-1](#) allow standard designers to trade off output quantization and clipping noise. Actual noise inserted depends on the probability statistics of the Cb and Cr variables, but in general if CC and CD are larger than the maximum values calculated in [Equation 3-4](#) and [Equation 3-5](#), output values may clip, introducing clipping noise. However, the lower CC and CD values are chosen, the worse Cb and Cr values will use the available dynamic range, thus introducing more quantization noise. Therefore, the designer's task is to equalize output quantization and clipping noise insertion by carefully choosing CC and CD values knowing the statistics of Cb and Cr values. For instance, when probabilities of extreme chrominance values are very small, it can be beneficial to increase CC and CD values, as the extra noise inserted by occasional clipping is less than the gain in average signal power (and thus SQNR).

Though a quantitative noise analysis of the signal flow graph based on [Figure 3-3](#) is possible by replacing quantizers with appropriate AWGN sources, the complexity of the derivation of a final noise formula which addresses clipping noise as well is beyond the scope of this document. Instead, [Table 3-5](#) illustrates noise figures for some typical (see [Table 3-2](#)) parameter combinations.

Table 3-5: Input and Output SNR Measurement Results [dB] for ITU-REC 601 (SD)

SNR	<i>IWIDTH</i> = <i>OWIDTH</i> = 8 Bits	<i>IWIDTH</i> = <i>OWIDTH</i> = 10 Bits	Input Range
SNR _{RGB} (input)	54.1	66.2	[0..255] (8bit)
SNR _Y	51.9	64.0	Or
SNR _{Cr}	47.0	58.9	[0..1023] (10 bit)
SNR _{Cb}	47.0	58.9	
SNR _{RGB} (input)	54.0	65.9	[16..240] (8bit)
SNR _Y	51.8	63.9	Or
SNR _{Cr}	46.9	58.8	[64..960] (10 bit)
SNR _{Cb}	46.9	58.8	
SNR _{RGB} (input)	53.8	65.8	[16..235] (8bit)
SNR _Y	51.5	63.6	Or
SNR _{Cr}	46.9	58.8	[64..920] (10 bit)
SNR _{Cb}	46.9	58.8	

Output Clipping Noise

If coefficients CC and CD in Equation 3-3 are larger than the maximum values calculated in Equation 3-4 and Equation 3-5, Cr and Cb output values may get larger (overflow) than the maximum or smaller (underflow) than minimum value the output representation can carry. If overflow occurs and the design does not have clipping logic (`HAS_CLIPPING=0`), binary values wrap around and insert substantial noise to the output. If `HAS_CLIPPING=1`, output values saturate, introducing less noise (Figure 3-4).

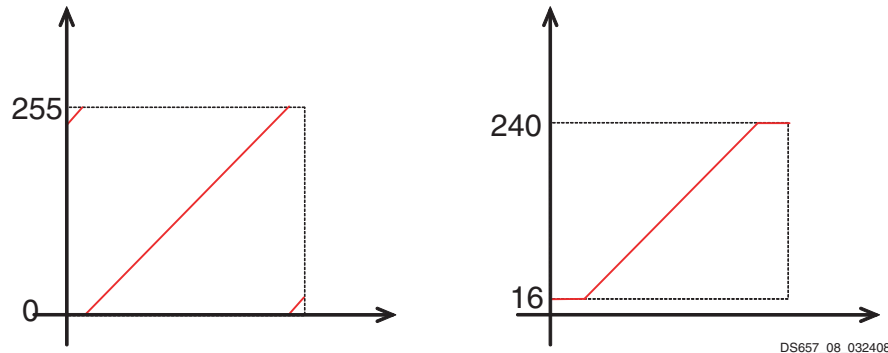

Figure 3-4: Wrap-Around and Saturation

Similarly, clamping logic is included in the design if `HAS_CLAMPING=1`. Use of clipping and clamping increases slice count of the design by approximately $6 \cdot \text{OWIDTH}$ slices.

If a targeted standard limits output of values to a predefined range other than those of binary representation, such as *ITU-R BT.601-5*, use of clipping and clamping logic facilitates constraining output values. These values are constrained to the predefined range by setting YMAX and YMIN values (constraining luminance), as well as CMAX and CMIN values (constraining chrominance) according to the standard specifications.

Clock, Enable, and Reset Considerations

ACLK

The master and slave AXI4-Stream video interfaces use the `ACLK` clock signal as their shared clock reference, as shown in Figure 3-5.

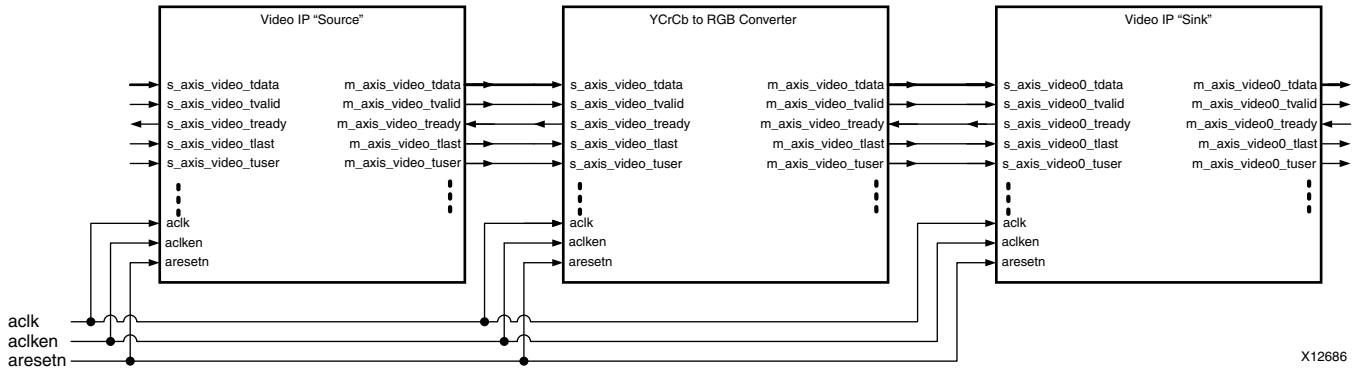

Figure 3-5: Example of ACLK Routing in an ISP Processing Pipeline

S_AXI_ACLK

The AXI4-Lite interface uses the A_AXI_ACLK pin as its clock source. The ACLK pin is not shared between the AXI4-Lite and AXI4-Stream interfaces. The RGB2YCrCb core contains clock-domain crossing logic between the ACLK (AXI4-Stream and Video Processing) and S_AXI_ACLK (AXI4-Lite) clock domains. The core automatically ensures that the AXI4-Lite transactions will complete even if the video processing is stalled with ARESETn, ACLKEN or with the video clock not running.

ACLKEN

The RGB2YCrCb core has two enable options: the ACLKEN pin (hardware clock enable), and the software reset option provided via the AXI4-Lite control interface (when present).

ACLKEN is by no means synchronized internally to AXI4-Stream frame processing therefore de-asserting ACLKEN for extended periods of time may lead to image tearing.

The ACLKEN pin facilitates:

- Multi-cycle path designs (high speed clock division without clock gating),
- Standby operation of subsystems to save on power
- Hardware controlled bring-up of system components



IMPORTANT: When ACLKEN (clock enable) pins are used (toggled) in conjunction with a common clock source driving the master and slave sides of an AXI4-Stream interface, the ACLKEN pins associated with the master and slave component interfaces must also be driven by the same signal to prevent transaction errors (Figure 2-2).



IMPORTANT: *When two cores connected via AXI4-Stream interfaces, where only the master or the slave interface has an ACLKEN port, which is not permanently tied high, the two interfaces should be connected via the AXI4-Stream Interconnect or AXI-FIFO cores to avoid data corruption (Figure 2-4).*

S_AXI_ACLKEN

The S_AXI_ACLKEN is the clock enable signal for the AXI4-Lite interface only. Driving this signal low will only affect the AXI4-Lite interface and will not halt the video processing in the ACLK clock domain.

ARESETn

The RGB2YCrCb core has two reset source: the ARESETn pin (hardware reset), and the software reset option provided via the AXI4-Lite control interface (when present).



IMPORTANT: *ARESETn is not synchronized internally to AXI4-Stream frame processing, therefore de-asserting ARESETn while a frame is being process will lead to image tearing.*

The external reset pulse needs to be held for 32 ACLK cycles to reset the core. The ARESETn signal will only reset the AXI4-Stream interfaces. The AXI4-Lite interface is unaffected by the ARESETn signal to allow the video processing core to be reset without halting the AXI4-Lite interface.



IMPORTANT: *When a system with multiple-clocks and corresponding reset signals are being reset, the reset generator has to ensure all reset signals are asserted/de-asserted long enough that all interfaces and clock-domains in all IP cores are correctly reinitialized.*

S_AXI_ARESETn

The S_AXI_ARESETn signal is synchronous to the S_AXI_ACLK clock domain, but is internally synchronized to the ACLK clock domain. The S_AXI_ARESETn signal will reset the entire core including the AXI4-Lite and AXI4-Stream interfaces.

System Considerations

When using the RGB2YCrCb, it needs to be configured for the actual video frame size, to operate properly. To gather the frame size information from the video, it can be connected to the Video In to AXI4-Stream input and the Video Timing Controller. The timing detector logic in the Video Timing Controller will gather the video timing signals. The AXI4-Lite control interface on the Video Timing Controller allows the system processor to read out

the measured frame dimensions, and program all downstream cores, such as the RGB2YCrCb, with the appropriate image dimensions.

If the target system uses only one setup for the RGB2YCrCb core, the user may choose to consolidate the active size and the other core specific register values, and create a constant configuration by removing the AXI4-Lite interface. This option allows reducing the core Slice footprint.

Clock Domain Interaction

The `ARESETn` and `ACLKEN` input signals will not reset or halt the AXI4-Lite interface. This allows the video processing to be reset or halted separately from the AXI4-Lite interface without disrupting AXI4-Lite transactions.

The AXI4-Lite interface will respond with an error if the core registers cannot be read or written within 128 `S_AXI_ACLK` clock cycles. The core registers cannot be read or written if the `ARESETn` signal is held low, if the `ACLKEN` signal is held low or if the `ACLK` signal is not connected or not running. If core register read does not complete, the AXI4-Lite read transaction will respond with **10** on the `S_AXI_RRESP` bus. Similarly, if a core register write does not complete, the AXI4-Lite write transaction will respond with **10** on the `S_AXI_BRESP` bus. The `S_AXI_ARESETn` input signal resets the entire core.

Programming Sequence

If processing parameters such as the image size needs to be changed on the fly, or the system needs to be reinitialized, it is recommended that pipelined Xilinx IP video cores are disabled/reset from system output towards the system input, and programmed/enabled from system input to system output. `STATUS` register bits allow system processors to identify the processing states of individual constituent cores, and successively disable a pipeline as one core after another is finished processing the last frame of data.

Error Propagation and Recovery

Parameterization and/or configuration registers define the dimensions of video frames video IP should process. Starting from a known state, based on these configuration settings the IP can predict when the beginning of the next frame is expected. Similarly, the IP can predict when the last pixel of each scan line is expected. SOF detected before it was expected (early), or SOF not present when it is expected (late), EOL detected before expected (early), or EOL not present when expected (late), signals error conditions indicative of either upstream communication errors or incorrect core configuration.

When SOF is detected early, the output SOF signal is generated early, terminating the previous frame immediately. When SOF is detected late, the output SOF signal is generated according to the programmed values. Extra lines / pixels from the previous frame are dropped until the input SOF is captured.

Similarly, when EOL is detected early, the output EOL signal is generated early, terminating the previous line immediately. When EOL is detected late, the output EOL signal is generated according to the programmed values. Extra pixels from the previous line are dropped until the input EOL is captured.

C-Model Reference

Installation and Directory Structure

This chapter contains information for installing the RGB to YCrCb Color-Space Converter C-Model, and describes the file contents and directory structure.

Software Requirements

The RGB to YCrCb Color-Space Converter v6.01.a C-models were compiled and tested with the following software versions.

Table 4-1: Supported Systems and Software Requirements

Platform	C-Compiler
Linux 32-bit and 64-bit	GCC 4.1.1
Windows 32-bit and 64-bit	Microsoft Visual Studio 2005, Visual Studio 2008 (Visual C++ 8.0)

Installation

The installation of the C-Model requires updates to the PATH variable, as described below.

Linux

Ensure that the directory in which the `libIp_v_rgb2ycrcb_v6_01_a_bitacc_cmodel.so` and `libstlport.so.5.1` files are located is in your `$LD_LIBRARY_PATH` environment variable.

C-Model File Contents

Unzipping the `v_rgb2ycrcb_v6_01_a_bitacc_model.zip` file creates the following directory structures and files which are described in [Table 4-2](#).

Table 4-2: C-Model Files

File	Description
/lin	Pre-compiled bit accurate ANSI C reference model for simulation on 32-bit Linux Platforms
libIp_v_rgb2ycrcb_v6_01_a_bitacc_cmodel.lib	RGB to YCrCb Color-Space Converter v6.01.a model shared object library (Linux platforms only)
libstlport.so.5.1	STL library, referenced by the RGB to YCrCb Color-Space Converter library (Linux platforms only)
run_bitacc_cmodel	Pre-compiled bit accurate executable for simulation on 32-bit Linux Platforms
/lin64	Pre-compiled bit accurate ANSI C reference model for simulation on 64-bit Linux Platforms
libIp_v_rgb2ycrcb_v6_01_a_bitacc_cmodel.lib	RGB to YCrCb Color-Space Converter v6.01.a model shared object library (Linux platforms only)
libstlport.so.5.1	STL library, referenced by the RGB to YCrCb Color-Space Converter library (Linux platforms only)
run_bitacc_cmodel	Pre-compiled bit accurate executable for simulation on 32-bit Linux Platforms
/nt	Pre-compiled bit accurate ANSI C reference model for simulation on 32-bit Windows Platforms
libIp_v_rgb2ycrcb_v6_01_a_bitacc_cmodel.lib	Pre-compiled library file for win32 compilation
run_bitacc_cmodel.exe	Pre-compiled bit accurate executable for simulation on 32-bit Windows Platforms
/nt64	Pre-compiled bit accurate ANSI C reference model for simulation on 64-bit Windows Platforms
libIp_v_rgb2ycrcb_v6_01_a_bitacc_cmodel.lib	Pre-compiled library file for win32 compilation
run_bitacc_cmodel.exe	Pre-compiled bit accurate executable for simulation on 64-bit Windows Platforms
README.txt	Release notes
pg013_v_rgb2ycrcb.pdf	<i>RGB to YCrCb Color-Space Converter Core Product Guide</i>
v_rgb2ycrcb_v6_01_a_bitacc_cmodel.h	Model header file
rgb_utils.h	Header file declaring the RGB image / video container type and support functions
bmp_utils.h	Header file declaring the bitmap (.bmp) image file I/O functions
video_utils.h	Header file declaring the generalized image / video container type, I/O and support functions.

Table 4-2: C-Model Files (Cont'd)

File	Description
Test_stimuli.bmp	32x32 sample test image
run_bittacc_cmodel.c	Example code calling the C-Model

Using the C-Model

The bit accurate C-model is accessed through a set of functions and data structures that are declared in the `v_rgb2ycrcb_v6_01_a_bitacc_cmodel.h` file. Before using the model, the structures holding the inputs, generics and output of the RGB to YCrCb Color-Space Converter instance must be defined:

```

struct xilinx_ip_v_rgb2ycrcb_v6_01_a_generics generics;
struct xilinx_ip_v_rgb2ycrcb_v6_01_a_inputs inputs;
struct xilinx_ip_v_rgb2ycrcb_v6_01_a_outputs outputs;
    
```

The declaration of these structures is in the `v_rgb2ycrcb_v6_01_a_bitacc_cmodel.h` file. Table 4-3 lists the generic parameters taken by the RGB to YCrCb Color-Space Converter v6.01.a IP core bit accurate model, as well as the default values.

Table 4-3: Core Generic Parameters and Default Values

Generic Variable	Type	Default Value	Range	Description
IWIDTH	int	8	8,10,12,16	Input data width
OWIDTH	int	8	8,10,12,16	Output width The OWIDTH must equal the IWIDTH.
ACOEFF	double	0.299	0.0 - 1.0	A Coefficient ¹ 0.0 < ACOEFF + BCOEFF < 1.0
BCOEFF	double	0.114	0.0 - 1.0	B Coefficient ¹ 0.0 < ACOEFF + BCOEFF < 1.0
CCOEFF	double	0.713	0.0 - 0.9	C Coefficient ¹
DCEFF	double	0.564	0.0 - 0.9	D Coefficient ¹
YOFFSET	int	16	0 - 2 ^{OWIDTH} -1	Offset for the Luminance Channel
CBOFFSET	int	128	0 - 2OWIDTH-1	Offset for the Cb Chrominance Channel
CROFFSET	int	128	0 - 2OWIDTH-1	Offset for the Cr Chrominance Channel
YMIN	int	16	0 - 2OWIDTH-1	Clamping value for the Luminance Channel
CBMIN	int	16	0 - 2OWIDTH-1	Clamping value for the Cb Chrominance Channel
CRMIN	int	16	0 - 2OWIDTH-1	Clamping value for the Cr Chrominance Channel
YMAX	int	240	0 - 2OWIDTH-1	Clipping value for the Luminance Channel
CBMAX	int	240	0 - 2OWIDTH-1	Clipping value for the Cb Chrominance Channel
CRMAX	int	240	0 - 2OWIDTH-1	Clipping value for the Cr Chrominance Channel

Table 4-3: Core Generic Parameters and Default Values (Cont'd)

HAS_CLIP	int	1	0,1	Determines if Clipping is performed on the output data
HAS_CLAMP	int	1	0,1	Determines if Clamping is performed on the output data

Calling `xilinx_ip_v_rgb2ycrcb_v6_01_a_get_default_generics(&generics)` initializes the generics structure with the default value.

The `inputs` structure defines the actual input image. For the description of the input video structure, see [Input and Output Video Structures](#).

Calling `xilinx_ip_v_rgb2ycrcb_v6_01_a_get_default_inputs(&generics, &inputs)` initializes the input video structure before it can be assigned an image or video sequence using the memory allocation or file I/O functions provided in the BMP, RGB or video utility functions.

Note: The `video_in` variable is not initialized to point to a valid image/video container, as the container size depends on the actual test image to be simulated. The initialization of the `video_in` structure is described in [C-model Example Code](#).

After the inputs are defined, the model can be simulated by calling this function:

```
int xilinx_ip_v_rgb2ycrcb_v6_01_a_bitacc_simulate(
    struct xilinx_ip_v_rgb2ycrcb_v6_01_a_generics* generics,
    struct xilinx_ip_v_rgb2ycrcb_v6_01_a_inputs* inputs,
    struct xilinx_ip_v_rgb2ycrcb_v6_01_a_outputs* outputs).
```

Results are included in the `outputs` structure, which contains only one member, type `video_struct`. After the outputs are evaluated and saved, dynamically allocated memory for input and output video structures must be released by calling this function:

```
void xilinx_ip_v_rgb2ycrcb_v6_01_a_destroy(
    struct xilinx_ip_v_rgb2ycrcb_v6_01_a_inputs *input,
    struct xilinx_ip_v_rgb2ycrcb_v6_01_a_outputs *output).
```

Successful execution of all provided functions, except for the destroy function, return value 0. A non-zero error code indicates that problems occurred during function calls.

Input and Output Video Structures

Input images or video streams can be provided to the RGB to YCrCb Color-Space Converter v6.01.a reference model using the `video_struct` structure, defined in `video_utils.h`:

```
struct video_struct{
    int frames, rows, cols, bits_per_component, mode;
    uint16*** data[5]; };
```

Table 4-4: Member Variables of the Video Structure

Member Variable	Designation
frames	Number of video/image frames in the data structure.
rows	Number of rows per frame. Pertaining to the image plane with the most rows and columns, such as the luminance channel for YUV data. Frame dimensions are assumed constant through all frames of the video stream. However different planes, such as y, u and v can have different dimensions.
cols	Number of columns per frame. Pertaining to the image plane with the most rows and columns, such as the luminance channel for YUV data. Frame dimensions are assumed constant through all frames of the video stream. However different planes, such as y, u and v can have different dimensions.
bits_per_component	Number of bits per color channel/component. All image planes are assumed to have the same color/component representation. Maximum number of bits per component is 16.
mode	Contains information about the designation of data planes. Named constants to be assigned to mode are listed in Table 4-5 .
data	Set of five pointers to three dimensional arrays containing data for image planes. Data is in 16-bit unsigned integer format accessed as data[plane][frame][row][col].

Table 4-5: Named Video Modes with Corresponding Planes and Representations¹

Mode	Planes	Video Representation
FORMAT_MONO	1	Monochrome – Luminance only
FORMAT_RGB	3	RGB image/video data
FORMAT_C444	3	444 YUV, or YCrCb image/video data
FORMAT_C422	3	422 format YUV video, (u, v chrominance channels horizontally sub-sampled)
FORMAT_C420	3	420 format YUV video, (u, v sub-sampled both horizontally and vertically)
FORMAT_MONO_M	3	Monochrome (Luminance) video with Motion
FORMAT_RGBA	4	RGB image/video data with alpha (transparency) channel
FORMAT_C420_M	5	420 YUV video with Motion
FORMAT_C422_M	5	422 YUV video with Motion
FORMAT_C444_M	5	444 YUV video with Motion
FORMAT_RGBM	5	RGB video with Motion

¹ The Color Space Converter C-model supports FORMAT_RGB mode for the input and FORMAT_C444 for the output.

Initializing the Input Video Structure

The easiest way to assign stimuli values to the input video structure is to initialize it with an image or video. The `yuv_utils.h`, `bmp_util.h` and `video_util.h` header files packaged with the bit accurate C-models contain functions to facilitate file I/O.

Bitmap Image Files

The header `bmp_utils.h` declares functions that help access files in Windows Bitmap format (http://en.wikipedia.org/wiki/BMP_file_format). However, this format limits color depth to a maximum of 8-bits per pixel, and operates on images with three planes (R,G,B). Consequently, the following functions operate on arguments type `rgb8_video_struct`, which is defined in `rgb_utils.h`. Also, both functions support only true-color, non-indexed formats with 24-bits per pixel.

```
int write_bmp(FILE *outfile, struct rgb8_video_struct *rgb8_video);
int read_bmp(FILE *infile, struct rgb8_video_struct *rgb8_video);
```

Exchanging data between `rgb8_video_struct` and general `video_struct` type frames/videos is facilitated by these functions:

```
int copy_rgb8_to_video(struct rgb8_video_struct* rgb8_in,
                     struct video_struct* video_out );
int copy_video_to_rgb8(struct video_struct* video_in,
                     struct rgb8_video_struct* rgb8_out );
```

Note: All image/video manipulation utility functions expect both input and output structures initialized; for example, pointing to a structure that has been allocated in memory, either as static or dynamic variables. Moreover, the input structure must have the dynamically allocated container (data or r, g, b) structures already allocated and initialized with the input frame(s). If the output container structure is pre-allocated at the time of the function call, the utility functions verify and issue an error if the output container size does not match the size of the expected output. If the output container structure is not pre-allocated, the utility functions create the appropriate container to hold results.

Binary Image/Video Files

The `video_utils.h` header file declares functions that help load and save generalized video files in raw, uncompressed format.

```
int read_video( FILE* infile, struct video_struct* in_video);
int write_video(FILE* outfile, struct video_struct* out_video);
```

These functions serialize the `video_struct` structure. The corresponding file contains a small, plain text header defining, "Mode", "Frames", "Rows", "Columns", and "Bits per Pixel". The plain text header is followed by binary data, 16-bits per component in scan line continuous format. Subsequent frames contain as many component planes as defined by the video mode value selected. Also, the size (rows, columns) of component planes can differ within each frame as defined by the actual video mode selected.

YUV Image Files

The `yuv_utils.h` file declares functions that help access files in standard YUV format. It operates on images with three planes (Y, U and V). The following functions operate on arguments of type `yuv8_video_struct`, which is defined in `yuv_utils.h`:

```
int write_yuv8(FILE *outfile, struct yuv8_video_struct *yuv8_video);
int read_yuv8(FILE *infile, struct yuv8_video_struct *yuv8_video);
```

Exchanging data between `yuv8_video_struct` and general `video_struct` type frames/videos is facilitated by these functions:

```
int copy_yuv8_to_video(struct yuv8_video_struct* yuv8_in,
struct video_struct* video_out );
int copy_video_to_yuv8(struct video_struct* video_in,
struct yuv8_video_struct* yuv8_out );
```

Working with Video_struct Containers

The `video_utils.h` header file defines functions to simplify access to video data in `video_struct`.

```
int video_planes_per_mode(int mode);
int video_rows_per_plane(struct video_struct* video, int plane);
int video_cols_per_plane(struct video_struct* video, int plane);
```

The `video_planes_per_mode` function returns the number of component planes defined by the mode variable, as described in [Table 4-5](#). The `video_rows_per_plane` and `video_cols_per_plane` functions return the number of rows and columns in a given plane of the selected video structure. The following example demonstrates using these functions in conjunction to process all pixels within a video stream stored in the `in_video` variable:

```
for (int frame = 0; frame < in_video->frames; frame++) {
  for (int plane = 0; plane < video_planes_per_mode(in_video->mode); plane++) {
    for (int row = 0; row < rows_per_plane(in_video,plane); row++) {
      for (int col = 0; col < cols_per_plane(in_video,plane); col++) {
        // User defined pixel operations on
        // in_video->data[plane][frame][row][col]
      }
    }
  }
}
```

C-model Example Code

An example C file, `run_bitacc_cmodel.c`, is provided to demonstrate the steps required to run the model. After following the compilation instructions, run the example executable. The executable takes the path/name of the input file and the path of the output as parameters. If invoked with insufficient parameters, this help message is issued:

```
Usage:run_bitacc_cmodel in_file out_path
       in_file  : path/name of the input file (24-bit RGB BMP file)
       out_path : path to to the output files
```

During successful execution, two directories are created at the location specified by the `out_path` command line parameter. The first directory is the "expected" directory. This directory contains a BMP file that corresponds to the output of the first frame that was processed. This directory also contains a txt file called `golden_1.txt`. This txt file contains the output of the model in a format that can be directly used with the demonstration test bench. The second directory that is created is the "stimuli" directory. This directory contains a txt file called `stimuli_1.txt`. This txt file contains the input of the model in a format that can be directly used with the demonstration test bench.

Compiling with the RGB to YCrCb C-Model

Linux (32- and 64-bit)

To compile the example code, first ensure that the directory in which the files `libIp_v_rgb2ycrcb_v6_01_a_bitacc_cmodel.so` and `libstlport.so.5.1` are located is present in your `$LD_LIBRARY_PATH` environment variable. These shared libraries are referenced during the compilation and linking process. Then `cd` into the directory where the header files, library files and `run_bitacc_cmodel.c` were unpacked. The libraries and header files are referenced during the compilation and linking process.

Place the header file and C source file in a single directory. Then in that directory, compile using the GNU C Compiler:

```
gcc -m32 -x c++ ../run_bitacc_cmodel.c ../gen_stim.c -o run_bitacc_cmodel -L.
-lIp_v_rgb2ycrcb_v6_01_a_bitacc_cmodel -Wl,-rpath,.

gcc -m64 -x c++ ../run_bitacc_cmodel.c ../gen_stim.c -o run_bitacc_cmodel -L.
-lIp_v_rgb2ycrcb_v6_01_a_bitacc_cmodel -Wl,-rpath,.
```

Windows (32- and 64-bit)

Precompiled library `v_rgb2ycrcb_v6_01_a_bitacc_cmodel.dll`, and top level demonstration code `run_bitacc_cmodel.c` should be compiled with an ANSI C compliant compiler under Windows. Here an example is presented using Microsoft Visual Studio.

In Visual Studio create a new, empty Windows Console Application project. As existing items, add:

- The `llibIpv_rgb2ycrcb_v6_01_a_bitacc_cmodel.dll` file to the "Resource Files" folder of the project

- The `run_bitacc_cmodel.c` and `gen_stim.c` files to the "Source Files" folder of the project
- The `v_rgb2ycrcb_v6_01_a_bitacc_cmodel.h` header files to "Header Files" folder of the project (optional)

After the project has been created and populated, it needs to be compiled and linked (built) to create a win32 executable. To perform the build step, choose **Build Solution** from the Build menu. An executable matching the project name has been created either in the Debug or Release subdirectories under the project location based on whether **Debug** or **Release** has been selected in the **Configuration Manager** under the Build menu.

SECTION II: VIVADO DESIGN SUITE

Customizing and Generating the Core

Constraining the Core

Detailed Example Design

Customizing and Generating the Core

This chapter includes information about using Xilinx tools to customize and generate the core in the Vivado Design Suite environment.

Graphical User Interface

The main screen of the Graphical User Interface (GUI) of Vivado (shown in [Figure 5-1](#)) allows quick implementation of standard RGB to YCrCb 4:4:4 or RGB to YUV 4:4:4 converter without having to manually enter values from [Table 3-2](#) through [Table 3-4](#). The Color-Space Converter core also supports proprietary (non-standard) converter implementations. This is done by selecting “custom” from the Standard Selection drop-down menu, as long as the custom conversion matrix can be transformed to the form of [Equation 3-5](#).

The main screen is shown in [Figure 5-1](#). Descriptions of the options provided in the GUI screens are included in this section.

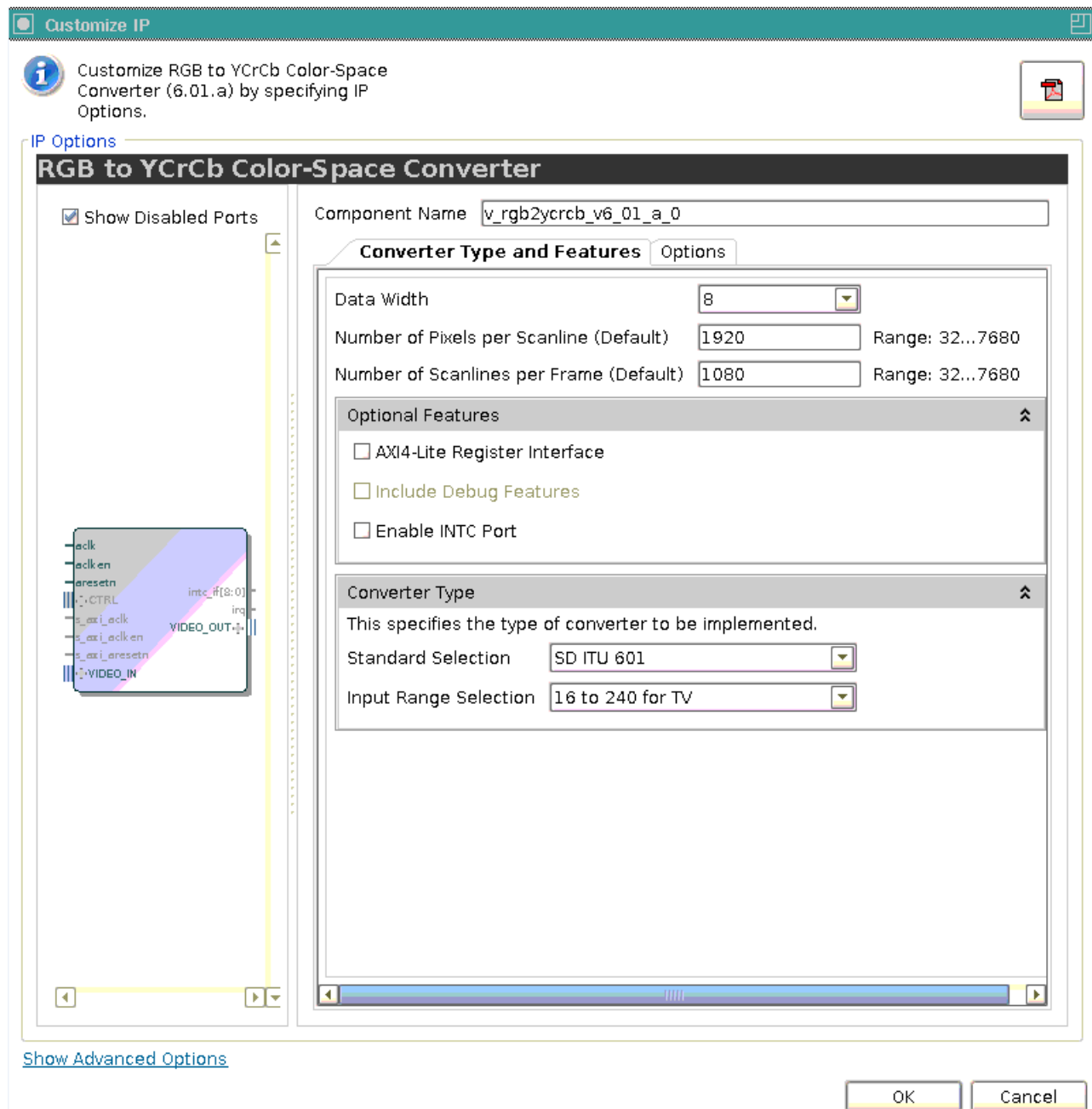

Figure 5-1: Color-Space Converter Main Screen

The first page of the GUI displays the following options:

- Component Name:** The component name is used as the base name of output files generated for the module. Names must begin with a letter and must be composed from characters a to z, 0 to 9 and "_". The component name **v_rgb2ycrcb_v6_01_a** is not a valid component name and should not be used.

- **Data Width:** Specifies the bit width of input samples. Permitted values are 8, 10, 12 and 16 bits.
- **Number of Active Pixels per Scan line:** When the AXI4-Lite control interface is enabled, the generated core will use the value specified in the CORE Generator GUI as the default value for the lower half-word of the ACTIVE_SIZE register. When an AXI4-Lite interface is not present, the GUI selection permanently defines the horizontal size of the frames the generated core instance is to process.
- **Number of Active Lines per Frame:** When the AXI4-Lite control interface is enabled, the generated core will use the value specified in the CORE Generator GUI as the default value for the upper half-word of the ACTIVE_SIZE register. When an AXI4-Lite interface is not present, the GUI selection permanently defines the vertical size (number of lines) of the frames the generated core instance is to process.
- **Optional Features:**
 - **AXI4-Lite Register Interface:** When selected, the core will be generated with an AXI4-Lite interface, which gives access to dynamically program and change processing parameters. For more information, refer to Control Interface in Chapter 2.
 - **Include Debugging Features:** When selected, the core will be generated with debugging features, which simplify system design, testing and debugging. For more information, refer to Debugging Features in Appendix C.



IMPORTANT: *Debugging features are only available when the AXI4-Lite Register Interface is selected.*

- **Enable INTC Port:** When selected, the core will generate the optional INTC_IF port, which gives parallel access to signals indicating frame processing status and error conditions. For more information, refer to The Interrupt Subsystem in Chapter 2.
- **Converter Type**
 - **Standard Selection:** Select the standard to be implemented. The offered standards are:
 - YCrCb ITU 601 (SD)
 - YCrCb ITU 709 (HD) 1125/60 (PAL)
 - YCrCb ITU 709 (HD) 1250/50 (NTSC)
 - YUV
 - custom

Selecting "custom" enables the controls on page 2 of the GUI, so conversion settings can be customized. Otherwise, page 2 only displays the parameters to be used to implement the selected standard.

- **Output Range Selection:** This selection governs the range of outputs Y, Cr and Cb by affecting the conversion coefficients as well as the clipping and clamping values. The core supports the following typical output ranges:
 - 16 to 235, typical for studio equipment
 - 16 to 240, typical for broadcast or television
 - 0 to 255, typical for computer graphics

Output clipping and clamping values are the same for luminance and chrominance channels. To set an asymmetric value, such as 16 to 235 for Cr and Cb and 16 to 240 for Y, select "custom" for the standard, then manually modify the clipping and clamping values on page 3.

The previously-mentioned ranges are characteristic for 8-bit outputs. If 10- or 12-bit outputs are used, the ranges are extended proportionally. For example, 16 to 240 mode for 10-bit outputs will result in output values ranging from 64 to 960.

The Conversion Matrix, Offset Compensation, Clipping and Clamping screen ([Figure 5-2](#)) displays and enables editing of conversion coefficients, similar to [Equation 3-9](#), [Equation 3-10](#), [Equation 3-11](#), and [Equation 3-12](#). Contents are editable only when "custom" is selected as the standard on page 1.

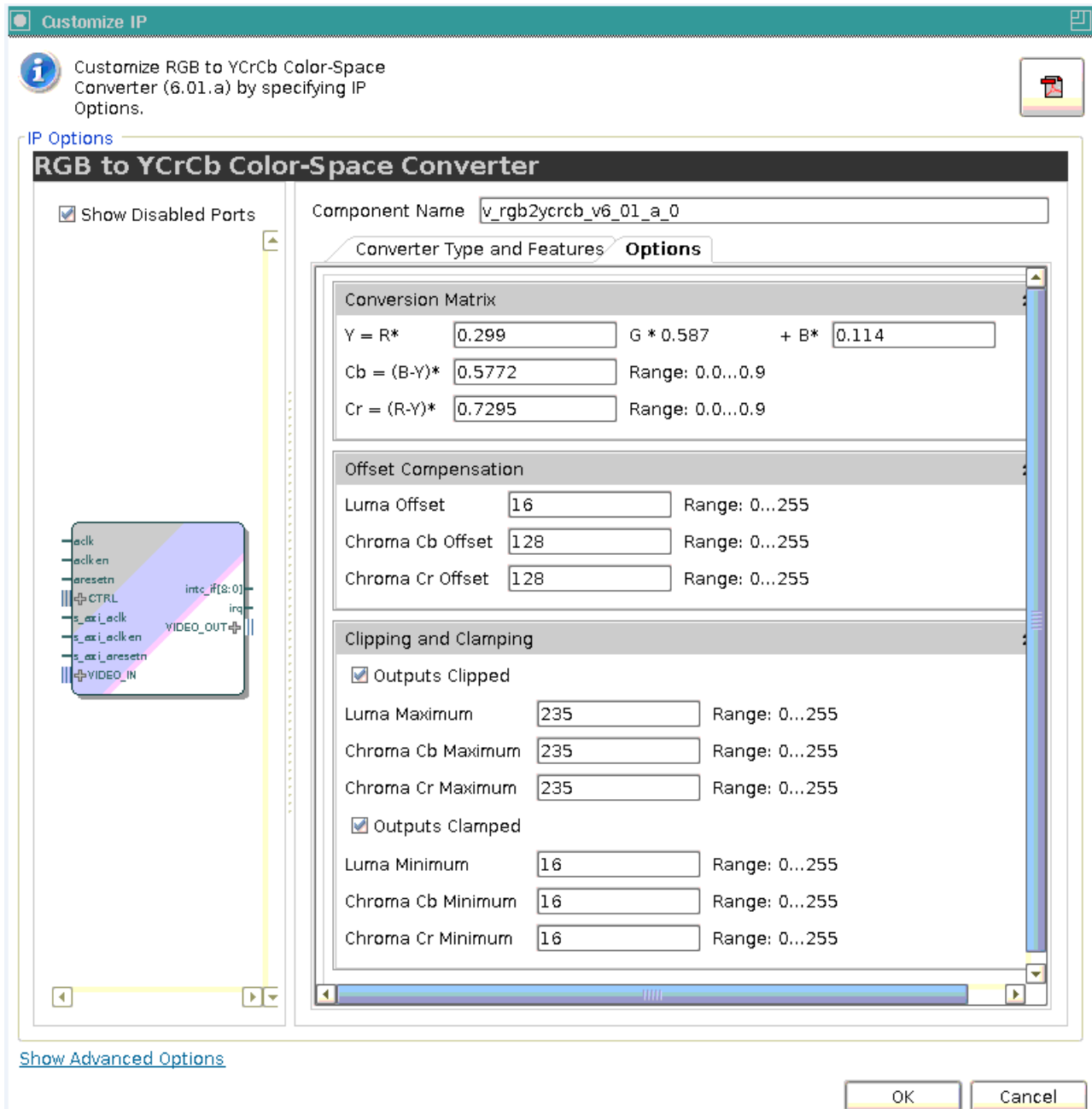

Figure 5-2: Conversion Matrix, Offset Compensation, Clipping and Clamping Screen

- **Conversion Matrix:** Enter floating-point conversion constants, ranging from 0 to 1, into the four fields representing CA, CB, CC and CD.
- **Offset Compensation:** Enter the offset compensation constants (YOFFSET, CbOffset, and CrOffset in Equation 3-9, Equation 3-10, Equation 3-11, and Equation 3-12). These constants are scaled to the output representation. If OY and OC are in the 0.0 – 1.0 range, and the output is represented as 10-bit unsigned integers, then luminance and chrominance offsets should be entered as integers in the 0-1023 range.

- **Outputs Clipped/Outputs Clamped:** These check boxes control whether clipping/clamping logic will be instantiated in the generated netlist. The clipping/clamping logic ensures no arithmetic wrap-arounds happen at the expense of extra slice-based logic resources.
- **Minimum and Maximum Values:** Similar to offset values, the edit-boxes take unsigned integer values in the range permitted by the current output representation.

Output Generation

Vivado design tools generate the files necessary to build the core and places those files in the `<project>/<project>.srcs/sources_1/ip/<core>` directory.

File Details

The Vivado design tools output consists of some or all the following files.

Name	Description
<code>v_rgb2ycrcb_v6_01_a</code>	Library directory for the <code>v_rgb2ycrcb_v6_01_a</code> core which contains the encrypted source files.
<code>v_tc_v5_01_a</code>	Library directory for the helper core which contain the encrypted source files used with the <code>v_rgb2ycrcb_v6_01_a</code>
<code><component_name>.veo</code>	The structural simulation model for the core. It is used for functionally simulating the core.
<code><component_name>.vho</code>	
<code><component_name>.xci</code>	IP-XACT file describing which options were used to generate the core. An XCI file can also be used as a source file for Vivado.
<code><component_name>.xml</code>	IP-XACT XML file describing how the core is constructed so Vivado can properly build the core.

Constraining the Core

Required Constraints

The `ACLK` pin should be constrained at the desired pixel clock rate for your video stream. The `S_AXI_ACLK` pin should be constrained at the frequency of the AXI4-Lite subsystem. In addition to clock frequency, the following constraints should be applied to cover all clock domain crossing data paths.

UCF

```
INST "**U_VIDEO_CTRL*/*SYNC2PROCCLK_I*/data_sync_reg[0]*" TNM =
"async_clock_conv_FFDEST";
TIMESPEC "TS_async_clock_conv" = FROM FFS TO "async_clock_conv_FFDEST" 2 NS
DATAPATHONLY;
INST "**U_VIDEO_CTRLk*/*SYNC2VIDCLK_I*/data_sync_reg[0]*" TNM =
"vid_async_clock_conv_FFDEST";
TIMESPEC "TS_vid_async_clock_conv" = FROM FFS TO "vid_async_clock_conv_FFDEST" 2 NS
DATAPATHONLY;
```

XDC

```
set_max_delay -to [get_cells -hierarchical -match_style ucf "**U_VIDEO_CTRL*/
*SYNC2PROCCLK_I*/data_sync_reg[0]*"] -datapath_only 2

set_max_delay -to [get_cells -hierarchical -match_style ucf "**U_VIDEO_CTRL*/
*SYNC2VIDCLK_I*/data_sync_reg[0]*"] -datapath_only 2
```

Device, Package, and Speed Grade Selections

There are no device, package, or speed grade requirements for this core. For a complete listing of supported devices, see the release notes for this core.

Clock Frequencies

The pixel clock (`ACLK`) frequency is the required frequency for this core. See [Maximum Frequencies in Chapter 2](#). The `S_AXI_ACLK` maximum frequency is the same as the `ACLK` maximum.

Clock Management

The core automatically handles clock domain crossing between the `ACLK` (video pixel clock and AXI4-Stream) and the `S_AXI_ACLK` (AXI4-Lite) clock domains. The `S_AXI_ACLK` clock can be slower or faster than the `ACLK` clock signal, but must not be more than 128x faster than `ACLK`.

Clock Placement

There are no specific Clock placement requirements for this core.

Banking

There are no specific Banking rules for this core.

Transceiver Placement

There are no Transceiver Placement requirements for this core.

I/O Standard and Placement

There are no specific I/O standards and placement requirements for this core.

Detailed Example Design

No example design is available at the time for the LogiCORE IP RGB to YCrCb Color-Space Converter v6.01a core.

Demonstration Test Bench

A demonstration test bench is provided with the core which enables you to observe core behavior in a typical scenario. This test bench is generated together with the core in Vivado design tools. You are encouraged to make simple modifications to the configurations and observe the changes in the waveform.

Generating the Test Bench

After customizing the IP, right-click on the core instance in **Sources** pane and select **Generate Output Products** ([Figure 7-1](#)).

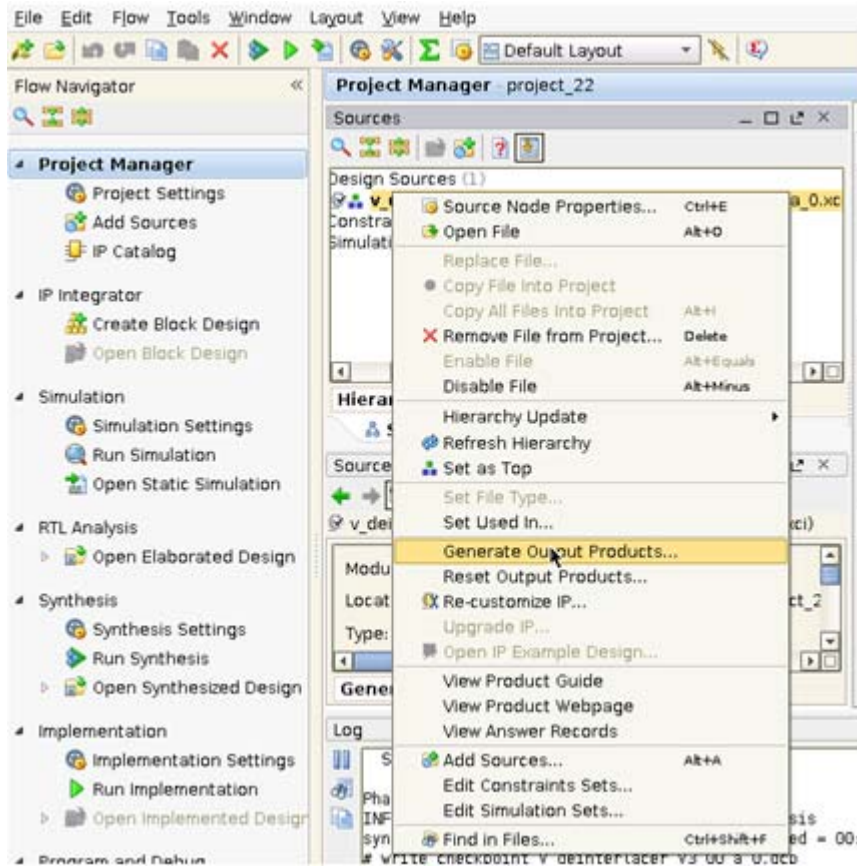

Figure 7-1: Sources Pane

A pop-up window prompts you to select items to generate.

Click on **Test Bench** and make sure **Action: Generate** is selected.

The demo test bench package will be generated in the following directory (Figure 7-2):

```
<PROJ_DIR>/<PROJ_NAME>.srcs/sources_1/ip/<IP_INSTANCE_NAME>/<IP_INSTANCE_NAME>/demo_tb/
```

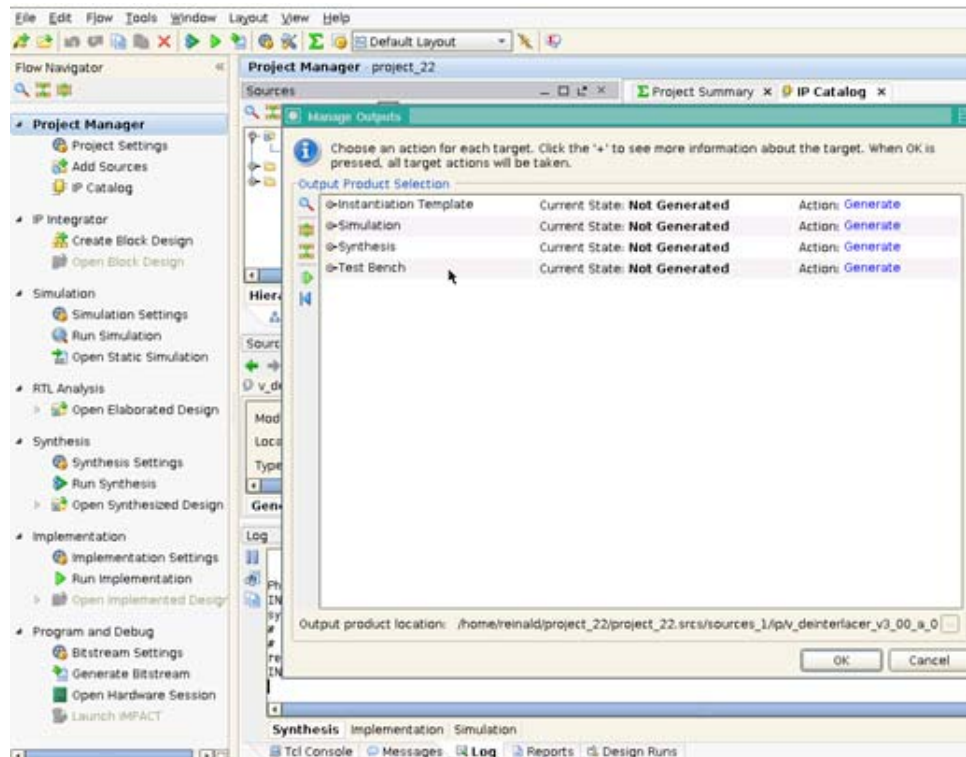

Figure 7-2: Test Bench

Directory and File Contents

The following files are expected to be generated in the in the demo test bench output directory:

- axi4lite_mst.v
- axi4s_video_mst.v
- axi4s_video_slv.v
- ce_generator.v
- tb_<IP_instance_name>.v

Test Bench Structure

The top-level entity is **tb_<IP_instance_name>**.

It instantiates the following modules:

- DUT
 - The <IP> core instance under test.
- axi4lite_mst

The AXI4-Lite master module, which initiates AXI4-Lite transactions to program core registers.

- `axi4s_video_mst`

The AXI4-Stream master module, which generates ramp data and initiates AXI4-Stream transactions to provide video stimuli for the core and can also be used to open stimuli files generated from the reference C-models and convert them into corresponding AXI4-Stream transactions.

To do this, edit `tb_<IP_instance_name>.v`:

- Add define macro for the stimuli file name and directory path

```
define STIMULI_FILE_NAME<path><filename>.
```
- Comment-out/remove the following line:

```
MST.is_ramp_gen(`C_ACTIVE_ROWS, `C_ACTIVE_COLS, 2);
```

and replace with the following line:

```
MST.use_file(`STIMULI_FILE_NAME);
```

For information on how to generate stimuli files, refer to [C-Model Reference](#).

- `axi4s_video_slv`

The AXI4-Stream slave module, which acts as a passive slave to provide handshake signals for the AXI4-Stream transactions from the core's output, can be used to open the data files generated from the reference C-model and verify the output from the core.

To do this, edit `tb_<IP_instance_name>.v`:

- Add define macro for the golden file name and directory path

```
define GOLDEN_FILE_NAME "<path><filename>".
```
- Comment-out the following line:

```
SLV.is_passive;
```

and replace with the following line:

```
SLV.use_file(`GOLDEN_FILE_NAME);
```

For information on how to generate golden files, refer to [C-Model Reference](#).

- `ce_gen`

Programmable Clock Enable (ACLKEN) generator.

Running the Simulation

There are two ways to run the demonstration test bench.

Option 1: Launch Simulation from the Vivado GUI

This runs the test bench with the AXI4-Stream Master producing ramp data as stimuli, and AXI4-Stream Slave set to passive mode.

- Click **Simulation Settings** in the Flow Navigation window, change Simulation top module name to **tb_<IP_instance_name>**.
- Click **Run Simulation**. XSIM launches and you should be able to see the signals.
- You can also choose Modelsim for simulation by going to **Project Settings** and selecting Modelsim as the Target Simulator ([Figure 7-3](#)).

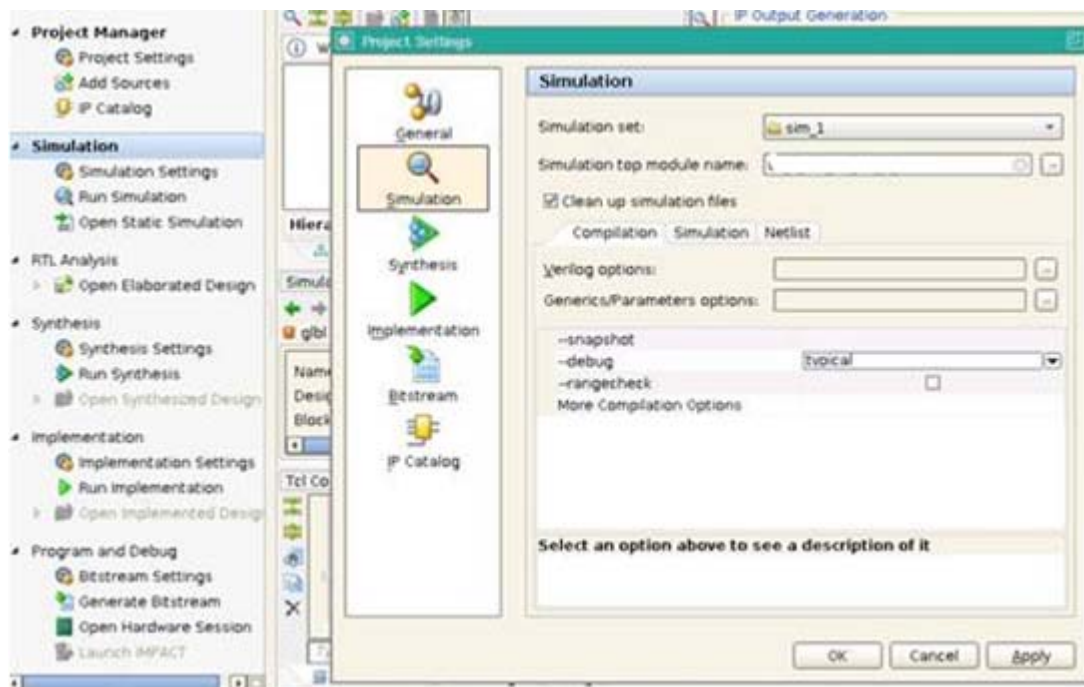

Figure 7-3: Simulation GUI

Option 2: Manually Compile and Run Simulation from the Simulation Environment

- Add the generated test bench files to a new simulation set, along with the customized IP. For information on the location of generated test bench files, refer to [Generating the Test Bench](#).
- Setup the environment variables for Xilinx libraries
- Compile the generated IP
- Compile the test bench files
- Run the simulation



RECOMMENDED: *Change the default simulation time from **1000 ns** to **all** to be able observe a full frame transaction.*

SECTION III: ISE DESIGN SUITE

Customizing and Generating the Core

Constraining the Core

Detailed Example Design

Customizing and Generating the Core

This chapter includes information about using Xilinx tools to customize and generate the core in the ISE® Design Suite environment.

Graphical User Interface

The main screen of the Graphical User Interface (GUI) of CORE Generator (shown in [Figure 8-1](#)) and EDK (shown in [Figure 8-3](#)) allows quick implementation of standard RGB to YCrCb 4:4:4 or RGB to YUV 4:4:4 converter without having to manually enter values from [Table 3-2](#) though [Table 3-4](#). The Color-Space Converter core also supports proprietary (non-standard) converter implementations. This is done by selecting “custom” from the Standard Selection drop-down menu, as long as the custom conversion matrix can be transformed to the form of [Equation 3-5](#).

The main screen is shown in [Figure 8-1](#). Descriptions of the options provided in the GUI screens are included in this section.

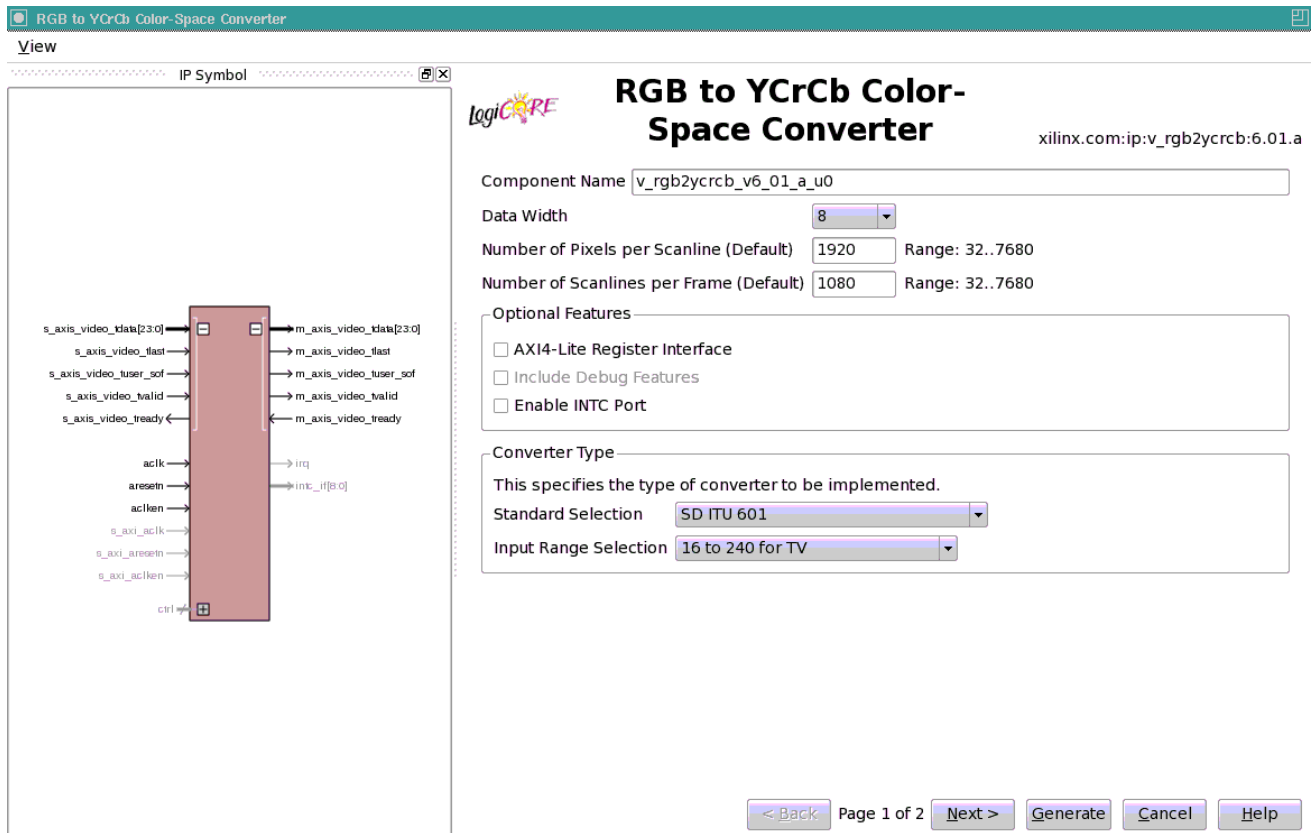

Figure 8-1: Color-Space Converter Main Screen

The first page of the GUI displays the following options:

- **Component Name:** The component name is used as the base name of output files generated for the module. Names must begin with a letter and must be composed from characters a to z, 0 to 9 and "_". The component name **v_rgb2ycrcb_v6_01_a** is not a valid component name and should not be used.
- **Data Width:** Specifies the bit width of input samples. Permitted values are 8, 10, 12 and 16 bits.
- **Number of Active Pixels per Scan line:** When the AXI4-Lite control interface is enabled, the generated core will use the value specified in the CORE Generator GUI as the default value for the lower half-word of the ACTIVE_SIZE register. When an AXI4-Lite interface is not present, the GUI selection permanently defines the horizontal size of the frames the generated core instance is to process.
- **Number of Active Lines per Frame:** When the AXI4-Lite control interface is enabled, the generated core will use the value specified in the CORE Generator GUI as the default value for the upper half-word of the ACTIVE_SIZE register. When an AXI4-Lite interface is not present, the GUI selection permanently defines the vertical size (number of lines) of the frames the generated core instance is to process.

- **Optional Features:**

- **AXI4-Lite Register Interface:** When selected, the core will be generated with an AXI4-Lite interface, which gives access to dynamically program and change processing parameters. For more information, refer to Control Interface in Chapter 2.
- **Include Debugging Features:** When selected, the core will be generated with debugging features, which simplify system design, testing and debugging. For more information, refer to Debugging Features in Appendix C.



IMPORTANT: Debugging features are only available when the AXI4-Lite Register Interface is selected.

- **Enable INTC Port:** When selected, the core will generate the optional INTC_IF port, which gives parallel access to signals indicating frame processing status and error conditions. For more information, refer to The Interrupt Subsystem in Chapter 2.

- **Converter Type**

- **Standard Selection:** Select the standard to be implemented. The offered standards are:
 - YCrCb *ITU 601* (SD)
 - YCrCb *ITU 709* (HD) 1125/60 (PAL)
 - YCrCb *ITU 709* (HD) 1250/50 (NTSC)
 - YUV
 - custom

Selecting “custom” enables the controls on page 2 of the GUI, so conversion settings can be customized. Otherwise, page 2 only displays the parameters to be used to implement the selected standard.

- **Output Range Selection:** This selection governs the range of outputs Y, Cr and Cb by affecting the conversion coefficients as well as the clipping and clamping values. The core supports the following typical output ranges:
 - 16 to 235, typical for studio equipment
 - 16 to 240, typical for broadcast or television
 - 0 to 255, typical for computer graphics

Output clipping and clamping values are the same for luminance and chrominance channels. To set an asymmetric value, such as 16 to 235 for Cr and Cb and 16 to 240 for Y, select “custom” for the standard, then manually modify the clipping and clamping values on page 3.

The previously-mentioned ranges are characteristic for 8-bit outputs. If 10, 12, or 16-bit outputs are used, the ranges are extended proportionally. For example, 16 to 240 mode for 10-bit outputs will result in output values ranging from 64 to 960.

The Conversion Matrix, Offset Compensation, Clipping and Clamping screen (Figure 8-2) displays and enables editing of conversion coefficients, similar to Equation 3-9, Equation 3-10, Equation 3-11, and Equation 3-12. Contents are editable only when "custom" is selected as the standard on page 1.

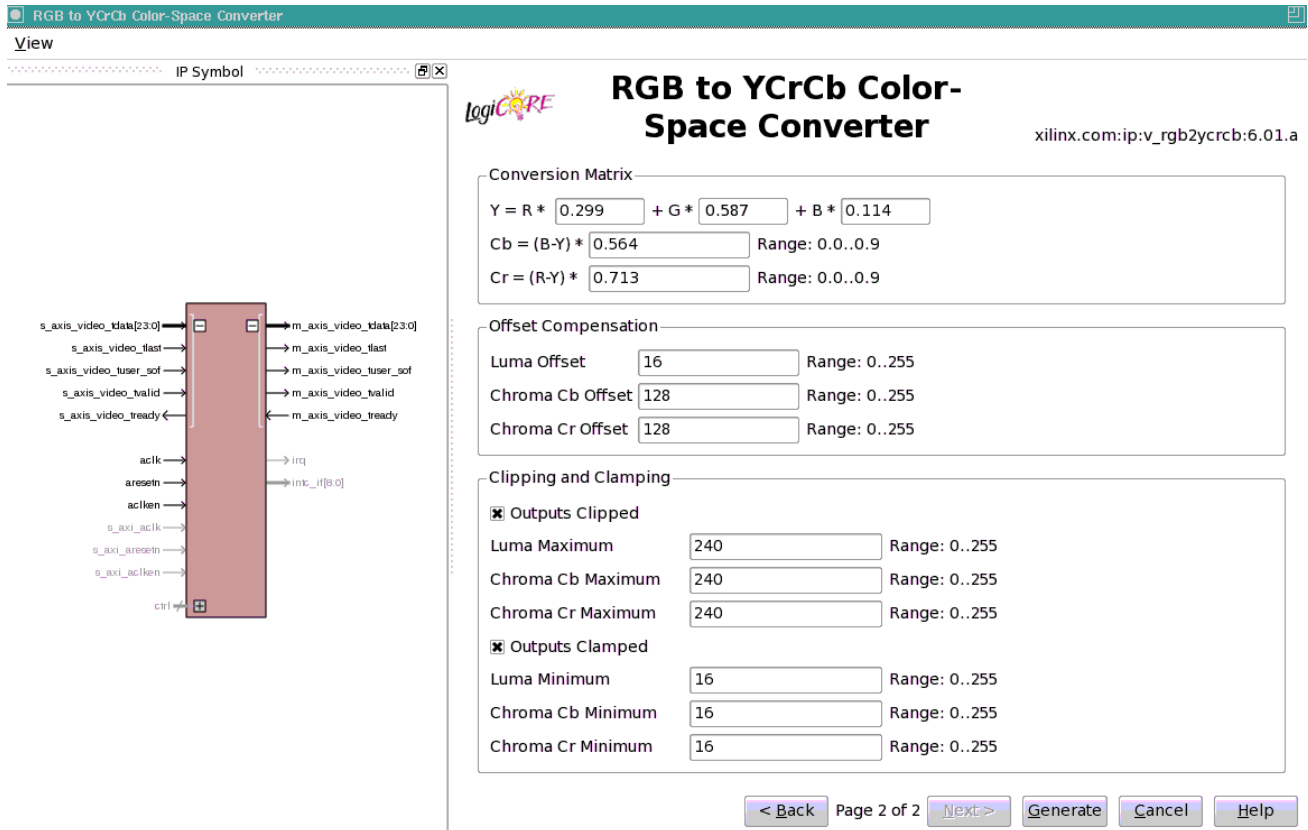

Figure 8-2: Conversion Matrix, Offset Compensation, Clipping and Clamping Screen

- **Conversion Matrix:** Enter floating-point conversion constants, ranging from 0 to 1, into the four fields representing CA, CB, CC and CD.
- **Offset Compensation:** Enter the offset compensation constants (YOFFSET, CbOffset, and CrOffset in Equation 3-9, Equation 3-10, Equation 3-11, and Equation 3-12). These constants are scaled to the output representation. If OY and OC are in the 0.0 – 1.0 range, and the output is represented as 10-bit unsigned integers, then luminance and chrominance offsets should be entered as integers in the 0-1023 range.
- **Outputs Clipped/Outputs Clamped:** These check boxes control whether clipping/clamping logic will be instantiated in the generated netlist. The clipping/clamping logic ensures no arithmetic wrap-arounds happen at the expense of extra slice-based logic resources.

- Minimum and Maximum Values:** Similar to offset values, the edit-boxes take unsigned integer values in the range permitted by the current output representation.

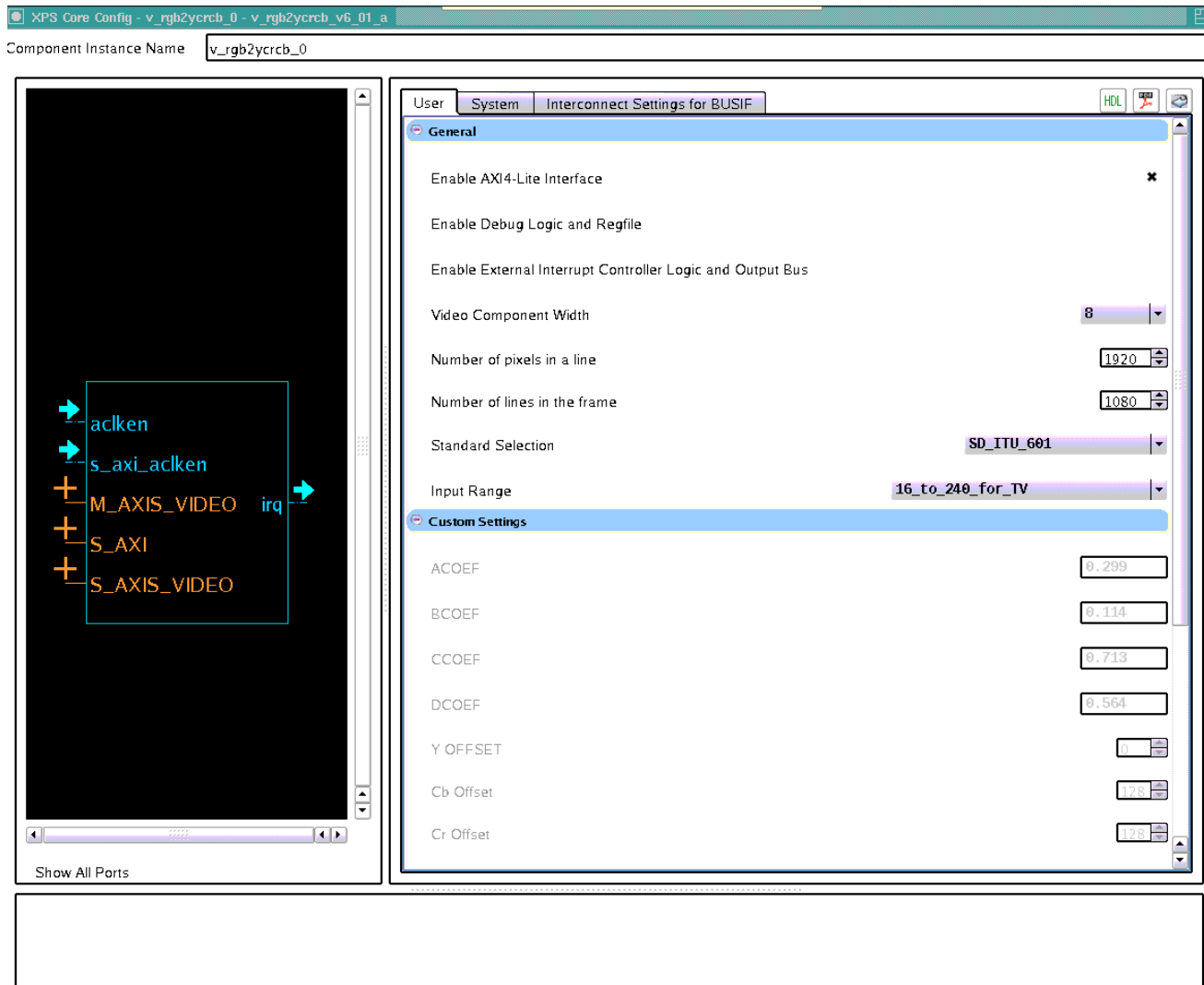

Figure 8-3: EDK GUI Screen with Default Setting

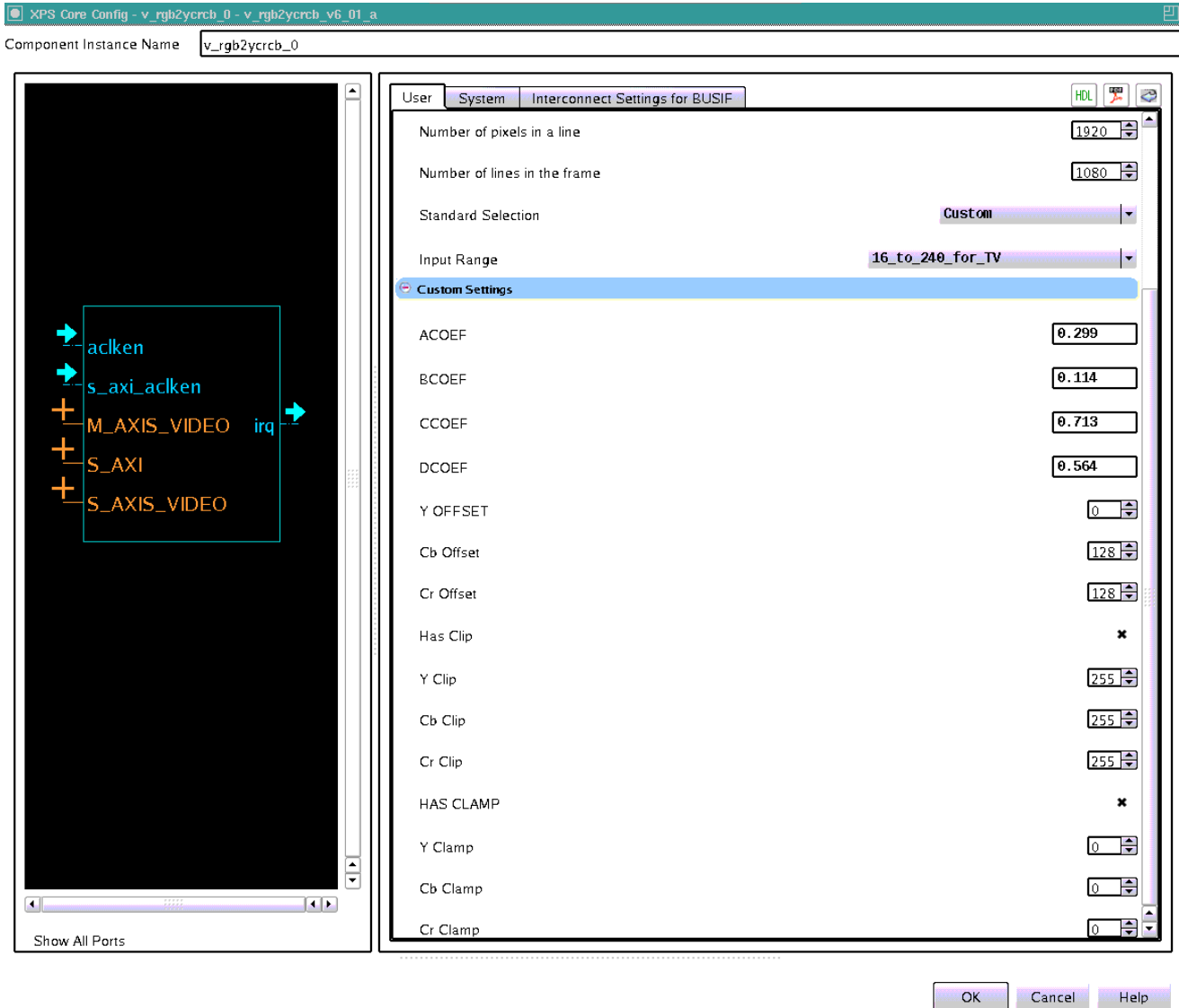

Figure 8-4: EDK GUI Screen with Custom Setting

Definitions of the EDK GUI controls are identical to the corresponding CORE Generator GUI functions.

Parameter Values in the XCO File

Table 8-1 defines valid entries for the XCO parameters.



TIP: Xilinx strongly suggests that XCO parameters are not manually edited in the XCO file; instead, use the CORE Generator software GUI to configure the core and perform range and parameter value checking.

The XCO parameters are helpful in defining the interface to other Xilinx tools.

Table 8-1: XCO Parameters

XCO Parameter	Default Values
component_name	v_rgb2ycrcb_v6_01_a_u0
s_axis_video_data_width	8
acoef	0.299
bcoef	0.114
ccoef	0.713
dcoef	0.564
cbmin	16
cbmax	240
cbmin	16
crmax	16
crmin	240
ymin	240
cboffset	128
croffset	128
yoffset	16
has_clamp	true
has_clip	true
input_range	16_to_240_for TV
standard_sel	SD_ITU_601
active_cols	1920
active_rows	1080
has_axi4_lite	false
has_debug	false
has_intc_if	false

Output Generation

CORE Generator will output the core as a netlist that can be inserted directly in an HDL design. EDK will output the core as a pCore that can be inserted into an EDK Project. The output is placed in the <project directory>.

File Details

The CORE Generator output consists of some or all the following files.

Name	Description
<component_name>_readme.txt	Readme file for the core.
<component_name>.ngc	The netlist for the core.
<component_name>.veo	The HDL template for instantiating the core.
<component_name>.vho	
<component_name>.v	The structural simulation model for the core. It is used for functionally simulating the core.
<component_name>.vhd	
<component_name>.xco	Log file from CORE Generator software describing which options were used to generate the core. An XCO file can also be used as an input to the CORE Generator software.

Constraining the Core

Required Constraints

The `ACLK` pin should be constrained at the desired pixel clock rate for your video stream.

The `S_AXI_ACLK` pin should be constrained at the frequency of the AXI4-Lite subsystem.

In addition to clock frequency, the following constraints should be applied to cover all clock domain crossing data paths.

UCF

```
INST "*U_VIDEO_CTRL*/*SYNC2PROCCLK_I*/data_sync_reg[0]*" TNM =
"async_clock_conv_FFDEST";
TIMESPEC "TS_async_clock_conv" = FROM FFS TO "async_clock_conv_FFDEST" 2 NS
DATAPATHONLY;
INST "*U_VIDEO_CTRLk*/*SYNC2VIDCLK_I*/data_sync_reg[0]*" TNM =
"vid_async_clock_conv_FFDEST";
TIMESPEC "TS_vid_async_clock_conv" = FROM FFS TO "vid_async_clock_conv_FFDEST" 2 NS
DATAPATHONLY;
```

XDC

```
set_max_delay -to [get_cells -hierarchical -match_style ucf "*U_VIDEO_CTRL*/
*SYNC2PROCCLK_I*/data_sync_reg[0]*"] -datapath_only 2

set_max_delay -to [get_cells -hierarchical -match_style ucf "*U_VIDEO_CTRL*/
*SYNC2VIDCLK_I*/data_sync_reg[0]*"] -datapath_only 2
```

Device, Package, and Speed Grade Selections

There are no device, package, or speed grade requirements for this core. For a complete listing of supported devices, see the release notes for this core.

Clock Frequencies

The pixel clock (`ACLK`) frequency is the required frequency for this core. See [Maximum Frequencies in Chapter 2](#). The `S_AXI_ACLK` maximum frequency is the same as the `ACLK` maximum.

Clock Management

The core automatically handles clock domain crossing between the `ACLK` (video pixel clock and AXI4-Stream) and the `S_AXI_ACLK` (AXI4-Lite) clock domains. The `S_AXI_ACLK` clock can be slower or faster than the `ACLK` clock signal, but must not be more than 128x faster than `ACLK`.

Clock Placement

There are no specific Clock placement requirements for this core.

Banking

There are no specific Banking rules for this core.

Transceiver Placement

There are no Transceiver Placement requirements for this core.

I/O Standard and Placement

There are no specific I/O standards and placement requirements for this core.

Detailed Example Design

No example design is available at the time for the LogiCORE IP RGB to YCrCb Color-Space Converter v6.01a core.

Demonstration Test Bench

A demonstration test bench is provided which enables core users to observe core behavior in a typical use scenario. The user is encouraged to make simple modifications to the test conditions and observe the changes in the waveform.

Test Bench Structure

The top-level entity, `tb_main.v`, instantiates the following modules:

- DUT
The RGB2YCrCb core instance under test.
- `axi4lite_mst`
The AXI4-Lite master module, which initiates AXI4-Lite transactions to program core registers.
- `axi4s_video_mst`
The AXI4-Stream master module, which opens the stimuli txt file and initiates AXI4-Stream transactions to provide stimuli data for the core
- `axi4s_video_slv`
The AXI4-Stream slave module, which opens the result txt file and verifies AXI4-Stream transactions from the core
- `ce_gen`
Programmable Clock Enable (`ACLKEN`) generator

Running the Simulation

- Simulation using ModelSim for Linux:
From the console, Type "source run_mti.sh".
 - Simulation using iSim for Linux:
From the console, Type "source run_isim.sh".
 - Simulation using ModelSim for Windows:
Double-click on "run_mti.bat" file.
 - Simulation using iSim:
Double-click on "run_isim.bat" file.
-

Directory and File Contents

The directory structure underneath the top-level folder is:

- **expected:**
Contains the pre-generated expected/golden data used by the test bench to compare actual output data.
- **stimuli:**
Contains the pre-generated input data used by the test bench to stimulate the core (including register programming values).
- **Results:**
Actual output data will be written to a file in this folder.
- **Src:**
Contains the .vhd simulation files and the .xco CORE Generator parameterization file of the core instance. The .vhd file is a netlist generated using CORE Generator. The .xco file can be used to regenerate a new netlist using CORE Generator.

The available core C-model can be used to generate stimuli and expected results for any user bmp image. For more information, refer to [Chapter 4, C-Model Reference](#).

The top-level directory contains packages and Verilog modules used by the test bench, as well as:

- **isim_wave.wcfg:**
Waveform configuration for ISIM
- **mti_wave.do:**
Waveform configuration for ModelSim

- run_isim.bat :
Runscript for iSim in Windows
- run_isim.sh:
Runscript for iSim in Linux
- run_mti.bat:
Runscript for ModelSim in Windows
- run_mti.sh:
Runscript for ModelSim in Linux

SECTION IV: APPENDICES

Verification, Compliance, and Interoperability

Migrating

Debugging

Application Software Development

Additional Resources

Verification, Compliance, and Interoperability

Simulation

A highly parameterizable test bench was used to test the RGB to YCrCb Color-Space Converter core. Testing included the following:

- Register accesses
 - Processing multiple frames of data
 - AXI4-Stream bidirectional data-throttling tests
 - Testing detection, and recovery from various AXI4-Stream framing error scenarios
 - Testing different `ACLKEN` and `ARESETn` assertion scenarios
 - Testing of various frame sizes
 - Varying parameter settings
-

Hardware Testing

The RGB to YCrCb Color-Space Converter core has been validated in hardware at Xilinx to represent a variety of parameterizations, including the following:

- A test design was developed for the core that incorporated a MicroBlaze™ processor, AXI4-Lite interconnect and various other peripherals. The software for the test system included pre-generated input and output data along with live video stream. The MicroBlaze processor was responsible for:
 - Initializing the appropriate input and output buffers
 - Initializing the RGB to YCrCb Color-Space Converter core
 - Launching the test
 - Comparing the output of the core against the expected results

- Reporting the Pass/Fail status of the test and any errors that were found

Interoperability

The Core uses AXI4-Stream interfaces that are compliant to the AXI4-Stream Video Protocol as described in the *Video IP: AXI Feature Adoption* section of the (UG761) *AXI Reference Guide* [Ref 1]. The core slave (input) AXI4-Stream interface can work directly with any Video core which produces RGB data compliant with the AXI4-Stream video protocol specification. The core master (output) interface can work directly with any Video core which consumes YUV 4:4:4 (YCrCb 4:4:4) data and is compliant with the AXI4-Stream Video Protocol specification.

Migrating

For information about migration from ISE Design Suite to Vivado Design Suite, see *Vivado Design Suite Migration Methodology Guide* (UG911) [Ref 8].

For a complete list of Vivado User and Methodology Guides, see the [Vivado Design Suite - 2012.3 User Guides web page](#).

From version v4.00.a to v5.00.a of the RGB2YCrCb core the following significant changes took place:

- XSVI interfaces were replaced by AXI4-Stream interfaces
- Since AXI4-Stream does not carry video timing data, the timing detector and timing generator modules were trimmed.
- Native support for EDK have been added - the RGB2YCrCb core appears in the EDK IP Catalog
- Debugging features have been added
- The AXI4-Lite control interface register map is standardized between Xilinx video cores

From v5.00.a to v6.00.a of the RGB2YCrCb core, the following changes took place:

- The core originally had `ac1k`, `ac1ken` and `aresetn` to control both the Video over AXI4-Stream and AXI4-Lite interfaces. Separate clock, clock enable and reset pins now control the Video over AXI4-Stream and the AXI4-Lite interfaces with clock domain crossing logic added to the core to handle the dissimilar clock domains between the AXI4-Lite and Video over AXI4-Stream domains.

From v6.00.a to v6.01.a of the RGB2YCrCb core, the following changes took place:

- Demonstration test bench included in Vivado
- Added support for 14.3 ISE, Vivado and EDK tool

Debugging

It is recommended to prototype the system with the AXI4-Stream interface enabled, so status and error detection, reset, and dynamic size programming can be used during debugging.

The following steps are recommended to bring-up/debug the core in a video/imaging system:

1. Bring up the AXI4-Lite interface
2. Bring up the AXI4-Stream interfaces

Once the core is working as expected, the user may consider 'hardening' the configuration by replacing the RGB2YCrCb core with an instance where GUI default values used for the register values, and the AXI4-Lite interface is disabled. This configuration reduces the core slice footprint.

Bringing up the AXI4-Lite Interface

Table C-1 describes how to troubleshoot the AXI4-Lite interface.

Table C-1: Troubleshooting the AXI4-Lite Interface

Symptom	Solution
Readback from the Version Register via the AXI4-Lite interface times out, or a core instance without an AXI4-Lite interface seems non-responsive.	Are the S_AXI_ACLK and ACLK pins connected? In EDK, verify that the S_AXI_ACLK and ACLK pin connections in the system.mhs file. The VERSION_REGISTER readout issue may be indicative of the core not receiving the AXI4-Lite interface.
Readback from the Version Register via the AXI4-Lite interface times out, or a core instance without an AXI4-Lite interface seems non-responsive.	Is the core enabled? Is s_axi_aclken connected to vcc? In EDK, verify that signal ACLKEN is connected in the system.mhs to either net_vcc or to a designated clock enable signal.

Table C-1: Troubleshooting the AXI4-Lite Interface (Cont'd)

Symptom	Solution
Readback from the Version Register via the AXI4-Lite interface times out, or a core instance without an AXI4-Lite interface seems non-responsive.	Is the core in reset? S_AXI_ARESETn and ARESETn should be connected to vcc for the core not to be in reset. In EDK, verify that the S_AXI_ARESETn and ARESETn signals are connected in the system.mhs to either net_vcc or to a designated reset signal.
Readback value for the VERSION_REGISTER is different from expected default values	The core and/or the driver in a legacy EDK/SDK project has not been updated. Ensure that old core versions, implementation files, and implementation caches have been cleared.

Assuming the AXI4-Lite interface works, the second step is to bring up the AXI4-Stream interfaces.

Bringing up the AXI4-Stream Interfaces

Table C-2 describes how to troubleshoot the AXI4-Stream interface.

Table C-2: Troubleshooting AXI4-Stream Interface

Symptom	Solution
Bit 0 of the ERROR register reads back set.	Bit 0 of the ERROR register, EOL_EARLY, indicates the number of pixels received between the latest and the preceding End-Of-Line (EOL) signal was less than the value programmed into the ACTIVE_SIZE register. If the value was provided by the Video Timing Controller core, read out ACTIVE_SIZE register value from the VTC core again, and make sure that the TIMING_LOCKED flag is set in the VTC core. Otherwise, using Chipscope, measure the number of active AXI4-Stream transactions between EOL pulses.
Bit 1 of the ERROR register reads back set.	Bit 1 of the ERROR register, EOL_LATE, indicates the number of pixels received between the last End-Of-Line (EOL) signal surpassed the value programmed into the ACTIVE_SIZE register. If the value was provided by the Video Timing Controller core, read out ACTIVE_SIZE register value from the VTC core again, and make sure that the TIMING_LOCKED flag is set in the VTC core. Otherwise, using Chipscope, measure the number of active AXI4-Stream transactions between EOL pulses.
Bit 2 or Bit 3 of the ERROR register reads back set.	Bit 2 of the ERROR register, SOF_EARLY, and bit 3 of the ERROR register SOF_LATE indicate the number of pixels received between the latest and the preceding Start-Of-Frame (SOF) differ from the value programmed into the ACTIVE_SIZE register. If the value was provided by the Video Timing Controller core, read out ACTIVE_SIZE register value from the VTC core again, and make sure that the TIMING_LOCKED flag is set in the VTC core. Otherwise, using Chipscope, measure the number EOL pulses between subsequent SOF pulses.

Table C-2: Troubleshooting AXI4-Stream Interface

Symptom	Solution
s_axis_video_tready stuck low, the upstream core cannot send data.	During initialization, line-, and frame-flushing, the RGB2YCrCb core keeps its s_axis_video_tready input low. Afterwards, the core should assert s_axis_video_tready automatically. Is m_axis_video_tready low? If so, the RGB2YCrCb core cannot send data downstream, and the internal FIFOs are full.
m_axis_video_tvalid stuck low, the downstream core is not receiving data	<ol style="list-style-type: none"> 1. No data is generated during the first two lines of processing. 2. If the programmed active number of pixels per line is radically smaller than the actual line length, the core drops most of the pixels waiting for the (s_axis_video_tlast) End-of-line signal. Check the ERROR register.
Generated SOF signal (m_axis_video_tuser0) signal misplaced.	Check the ERROR register.
Generated EOL signal (m_axis_video_tlast) signal misplaced.	Check the ERROR register.
Data samples lost between Upstream core and the RGB2YCrCb core. Inconsistent EOL and/or SOF periods received.	<ol style="list-style-type: none"> 1. Are the Master and Slave AXI4-Stream interfaces in the same clock domain? 2. Is proper clock-domain crossing logic instantiated between the upstream core and the RGB2YCrCb core (Asynchronous FIFO)? 3. Did the design meet timing? 4. Is the frequency of the clock source driving the RGB2YCrCb ACLK pin lower than the reported Fmax reached?
Data samples lost between Downstream core and the RGB2YCrCb core. Inconsistent EOL and/or SOF periods received.	<ol style="list-style-type: none"> 1. Are the Master and Slave AXI4-Stream interfaces in the same clock domain? 2. Is proper clock-domain crossing logic instantiated between the upstream core and the RGB2YCrCb core (Asynchronous FIFO)? 3. Did the design meet timing? 4. Is the frequency of the clock source driving the RGB2YCrCb ACLK pin lower than the reported Fmax reached?

If the AXI4-Stream communication is healthy, but the data seems corrupted, the next step is to find the correct configuration for the RGB2YCrCb core.

Debugging Features

The RGB2YCrCb core is equipped with optional debugging features which aim to accelerate system bring-up, optimize memory and data-path architecture and reduce time to market.

The optional debug features can be turned on/off via the **Include Debug Features** checkbox on the GUI when an AXI4-Lite interface is present. Turning off debug features reduces the core Slice footprint.

Core Bypass Option

The bypass option facilitates establishing a straight through connection between input (AXI4-Stream slave) and output (AXI4-Stream master) interfaces bypassing any processing functionality.

Flag `BYPASS` (bit 4 of the `CONTROL` register) can turn bypass on (1) or off, when the core instance Debugging Features were enabled at generation. Within the IP this switch controls multiplexers in the AXI4-Stream path.

In bypass mode the `RGB2YCrCb` core processing function is bypassed, and the core repeats AXI4-Stream input samples on its output. In bypass mode sensor samples are presented via the Green component output, while Red and Blue component outputs are set to zero.

Starting a system with all processing cores set to bypass, then by turning bypass off from the system input towards the system output allows verification of subsequent cores with known good stimuli.

Built in Test-Pattern Generator

The optional built-in test-pattern generator facilitates to temporarily feed the output AXI4-Stream master interface with a predefined pattern.

Flag `TEST_PATTERN` (bit 5 of the `CONTROL` register) can turn test-pattern generation on (1) or off, when the core instance Debugging Features were enabled at generation. Within the IP this switch controls multiplexers in the AXI4-Stream path, switching between the regular core processing output and the test-pattern generator. When enabled, a set of counters generate 256 scan-lines of color-bars, each color bar 64 pixels wide, repetitively cycling through Black, Red, Green, Yellow, Blue, Magenta, Cyan, and White colors till the end of each scan-line. After the Color-Bars segment, the rest of the frame is filled with a monochrome horizontal and vertical ramp.

Starting a system with all processing cores set to test-pattern mode, then by turning test-pattern generation off from the system output towards the system input allows successive bring-up and parameterization of subsequent cores.

Throughput Monitors

Throughput monitors enable the user to monitor processing performance within the core. This information can be used to help debug frame-buffer bandwidth limitation issues, and if possible, allow video application software to balance memory pathways.

Often times video systems, with multiport access to a shared external memory, have different processing islands. For example a pre-processing sub-system working in the input video clock domain may clean up, transform, and write a video stream, or multiple video streams, to memory. The processing sub-system may read the frames out, process, scale, encode, then write frames back to the frame buffer, in a separate processing clock domain. Finally, the output sub-system may format the data and read out frames locked to an external clock.

Typically, access to external memory using a multiport memory controller involves arbitration between competing streams. However, to maximize the throughput of the system, different memory ports may need different specific priorities. To fine tune the arbitration and dynamically balance frame rates, it is beneficial to have access to throughput information measured in different video data paths.

The SYSDEBUG0 (0x0014), or Frame Throughput Monitor, register indicates the number of frames processed since power-up or the last time the core was reset. The SYSDEBUG1 (0x0018), or Line Throughput Monitor, register indicates the number of lines processed since power-up or the last time the core was reset. The SYSDEBUG2 (0x001C), or Pixel Throughput Monitor, register indicates the number of pixels processed since power-up or the last time the core was reset.

Priorities of memory access points can be modified by the application software dynamically to equalize frame, or partial frame rates.

Interfacing to Third-Party IP

Table C-3 describes how to troubleshoot third-party interfaces.

Table C-3: Troubleshooting Third-Party Interfaces

Symptom	Solution
<p>Severe color distortion or color-swap when interfacing to third-party video IP.</p>	<p>Verify that the color component logical addressing on the AXI4-Stream TDATA signal is in according to Data Interface in Chapter 2. If misaligned: In HDL, break up the TDATA vector to constituent components and manually connect the slave and master interface sides. In EDK, create a new vector for the slave side TDATA connection. In the MPD file, manually assign components of the master-side TDATA vector to sections of the new vector.</p>
<p>Severe color distortion or color-swap when processing video written to external memory using the AXI-VDMA core.</p>	<p>Unless the particular software driver was developed with the AXI4-Stream TDATA signal color component assignments described in Data Interface in Chapter 2 in mind, there are no guarantees that the software will correctly identify bits corresponding to color components. Verify that the color component logical addressing TDATA is in alignment with the data format expected by the software drivers reading/writing external memory. If misaligned: In HDL, break up the TDATA vector to constituent components, and manually connect the slave and master interface sides. In EDK, create a new vector for the slave side TDATA connection. In the MPD file, manually assign components of the master-side TDATA vector to sections of the new vector.</p>

Application Software Development

Programmer's Guide

The software API is provided to allow easy access to the RGB2YCrCb AXI4-Lite registers defined in [Table 2-9, page 13](#). To utilize the API functions, the following two header files must be included in the user C code:

```
#include "rgb2ycrcb.h"
#include "xparameters.h"
```

The hardware settings of your system, including the base address of your RGB2YCrCb core, are defined in the `xparameters.h` file. The `rgb2ycrcb.h` file contains the macro function definitions for controlling the RGB2YCrCb pCore.

For examples on API function calls and integration into a user application, the `drivers` subdirectory of the pCore contains a file, `example.c`, in the `rgb2ycrcb_v6_01_a0_a/example` subfolder. This file is a sample C program that demonstrates how to use the RGB2YCrCb pCore API.

Table D-1: RGB2YCrCb Driver Function Definitions

Function Name and Parameterization	Description
RGB_Enable (uint32 BaseAddress)	Enables a RGB2YCrCb instance.
RGB_Disable (uint32 BaseAddress)	Disables a RGB2YCrCb instance.
RGB_Reset (uint32 BaseAddress)	Immediately resets a RGB2YCrCb instance. The core stays in reset until the RESET flag is cleared.
RGB_ClearReset (uint32 BaseAddress)	Clears the reset flag of the core, which allows it to re-sync with the input video stream and return to normal operation.
RGB_AutoSyncReset (uint32 BaseAddress)	Resets a RGB2YCrCb instance at the end of the current frame being processed, or immediately if the core is not currently processing a frame.
RGB_ReadReg (uint32 BaseAddress, uint32 RegOffset)	Returns the 32-bit unsigned integer value of the register. Read the register selected by RegOffset (defined in Table 2-12, page 19).

Table D-1: RGB2YCrCb Driver Function Definitions

Function Name and Parameterization	Description
RGB_WriteReg (uint32 BaseAddress, uint32 RegOffset, uint32 Data)	Write the register selected by RegOffset (defined in Table 2-12, page 19. Data is the 32-bit value to write to the register.
RGB_RegUpdateEnable (uint32 BaseAddress)	Enables copying double buffered registers at the beginning of the next frame. Refer to Double Buffering for more information.
RGB_RegUpdateDisable (uint32 BaseAddress)	Disables copying double buffered registers at the beginning of the next frame. Refer to Double Buffering for more information.
RGB_select_standard (int standard_sel, int input_range, int data_width, struct rgb_coef_inputs *coef_in)	Populates an rgb_coef_inputs structure with the values from the selected Video standard standard_sel 0 = SD_ITU_601 1 = HD_ITU_709_1125_NTSC 2 = HD_ITU_709_1250_PAL 3 = YUV input_range 0 = 16_to_240_for_TV, 1 = 16_to_235_for_Studio_Equipment 3 = 0_to_255_for_Computer_Graphics
RGB_coefficient_translation (struct rgb_coef_inputs *coef_in, struct rgb_coef_outputs *coef_out)	Translates the rgb_coef_inputs structure into the rgb_coef_outputs structure that can be used to program the core's registers. The rgb_coef_inputs structure uses the same values as the core's GUIs. The rgb_coef_outputs structure uses the values that can be programmed into the core's registers.
void RGB_set_coefficients (Xuint32 BaseAddress, struct rgb_coef_outputs *coef_out)	Writes the translated coefficient values to the core's registers.
void RGB_get_coefficients (Xuint32 BaseAddress, struct rgb_coef_outputs *coef_out)	Reads the translated coefficient values from the core's registers.

Software Reset

Software reset reinitializes registers of the AXI4-Lite control interface to their initial value, resets FIFOs, forces `m_axis_video_tvalid` and `s_axis_video_tready` to 0.

`RGB_Reset()` and `RGB_AutoSyncReset()` reset the core immediately if the core is not currently processing a frame. If the core is currently processing a frame calling `RGB_Reset()`, or setting bit 30 of the `CONTROL` register to 1 will cause image tearing. After calling `RGB_Reset()`, the core remains in reset until `RGB_ClearReset()` is called.

Calling `RGB_AutoSyncReset()` automates this reset process by waiting until the core finishes processing the current frame, then asserting the reset signal internally, keeping the core in reset only for 32 `ACLK` cycles, then deasserting the signal automatically. After calling

`RGB_AutoSyncReset()`, it is not necessary to call `RGB_ClearReset()` for the core to return to normal operating mode.



IMPORTANT: *Calling `RGB_AutoSyncReset()` does not guarantee prompt, or real-time resetting of the core. If the AXI4-Stream communication is halted mid frame, the core will not reset until the upstream core finishes sending the current frame or starts a new frame.*

Double Buffering

The `ACTIVE_SIZE` and the core specific registers are double-buffered to ensure no image tearing happens if values are modified during frame processing. Values from the AXI4-Lite interface are latched into processor registers immediately after writing, and processor register values are copied into the active register set at the Start Of Frame (SOF) signal. Double-buffering decouples AXI4-Lite register updates from the AXI4-Stream processing, allowing software a large window of opportunity to update processing parameter values without image tearing.

If multiple register values are changed during frame processing, simple double buffering would not guarantee that all register updates would take effect at the beginning of the same frame. Using a semaphore mechanism, the `RegUpdateEnable()` and `RegUpdateDisable()` functions allows synchronous commitment of register changes. The RGB2YCrCb core will start using the updated `ACTIVE_SIZE` and the core specific values only if the `REGUPDATE` flag of the `CONTROL` register is set (1), after the next Start-Of-Frame signal (`s_axis_video_tuser0`) is received. Therefore, it is recommended to disable the register update before writing multiple double-buffered registers, then enable register update when register writes are completed.

Reading and Writing Registers

Each software register that is defined in [Table 2-12](#) has a constant that is defined in `rgb2ycrcb.h` which is set to the offset for that register listed in [Table D-2](#). It is recommended that the application software uses the predefined register names instead of register values when accessing core registers, so future updates to the RGB2YCrCb drivers which may change register locations will not affect the application dependent on the RGB2YCrCb driver.

Table D-2: Predefined Constants Defined in `rgb2ycrcb.h`

Constant Name Definition	Value	Target Register
<code>RGB_CONTROL</code>	0x0000	<code>CONTROL</code>
<code>RGB_STATUS</code>	0x0004	<code>STATUS</code>
<code>RGB_ERROR</code>	0x0008	<code>ERROR</code>
<code>RGB_IRQ_ENABLE</code>	0x000C	<code>IRQ_ENABLE</code>

Table D-2: Predefined Constants Defined in rgb2ycrcb.h (Cont'd)

Constant Name Definition	Value	Target Register
RGB_VERSION	0x0010	VERSION
RGB_SYSDEBUG0	0x0014	SYSDEBUG0
RGB_SYSDEBUG1	0x0018	SYSDEBUG1
RGB_SYSDEBUG2	0x001C	SYSDEBUG2
RGB_ACTIVE_SIZE	0x0020	ACTIVE_SIZE
RGB_YMAX	0x100	YMAX
RGB_YMIN	0x104	YMIN
RGB_CBMAX	0x108	CBMAX
RGB_CBMIN	0x10C	CBMIN
RGB_CRMAX	0x110	CRMAX
RGB_CRMIN	0x114	CRMIN
RGB_YOFFSET	0x118	YOFFSET
RGB_CBOFFSET	0x11C	CBOFFSET
RGB_CROFFSET	0x120	CROFFSET
RGB_ACOEF	0x124	ACOEF
RGB_BCOEF	0x128	BCOEF
RGB_CCOEF	0x12C	CCOEF
RGB_DCOEF	0x130	DCOEF

Additional Resources

Xilinx Resources

For support resources such as Answers, Documentation, Downloads, and Forums, see the Xilinx Support website at:

<http://www.xilinx.com/support>.

For a glossary of technical terms used in Xilinx documentation, see:

http://www.xilinx.com/support/documentation/sw_manuals/glossary.pdf.

For a comprehensive listing of Video and Imaging application notes, white papers, reference designs and related IP cores, see the Video and Imaging Resources page at:

http://www.xilinx.com/esp/video/refdes_listing.htm#ref_des.

Solution Centers

See the [Xilinx Solution Centers](#) for support on devices, software tools, and intellectual property at all stages of the design cycle. Topics include design assistance, advisories, and troubleshooting tips.

References

These documents provide supplemental material useful with this user guide:

1. [UG761 AXI Reference Guide](#)
2. Jack, Keith. 2004. *Video Demystified*, 4th Edition. Burlington, MA: Newnes: pp 15-19.
3. Poynton, Charles. 2003. *Digital Video and HDTV*. San Francisco: Morgan Kaufmann: pp 302 - 321.
4. *ITU Recommendation BT.601-5*, International Telecommunication Union, 1995.
5. *ITU Recommendation BT.709-5*, International Telecommunication Union, 2002.
6. Proakis, John G., and Dimitris G. Manolakis. *Digital Signal Processing*, 3rd edition. Upper Saddle River, NJ: Prentice Hall: pp 755-756.
7. Sullivan, Gary. 2003. Approximate theoretical analysis of RGB to YCbCr to RGB conversion error. Presented for Joint Video Team (JVT) of ISO/IEC MPEG & ITU-T VCEG (ISO/IEC JTC1/SC29/WG11 and ITU-T SG16 Q.6), July 22-24, in Trondheim, Norway.
8. [Vivado Design Suite Migration Methodology Guide](#) (UG911)
9. [Vivado™ Design Suite user documentation](#)

Technical Support

Xilinx provides technical support at www.xilinx.com/support for this LogiCORE™ IP product when used as described in the product documentation. Xilinx cannot guarantee timing, functionality, or support of product if implemented in devices that are not defined in the documentation, if customized beyond that allowed in the product documentation, or if changes are made to any section of the design labeled DO NOT MODIFY.

See the IP Release Notes Guide ([XTP025](#)) for more information on this core. For each core, there is a master Answer Record that contains the Release Notes and Known Issues list for the core being used. The following information is listed for each version of the core:

- New Features
- Resolved Issues
- Known Issues

Revision History

The following table shows the revision history for this document.

Date	Version	Revision
10/19/2011	1.0	Initial Xilinx release of Product Guide, replacing DS657 and UG834.
4/24/2012	2.0	Updated for core version. Added Zynq-7000 devices, added AXI4-Stream interfaces, deprecated GPP interface.
7/25/2012	3.0	Updated for core version. Added Vivado interface.
10/16/2012	3.1	Updated for core version. Added Vivado test bench.

Notice of Disclaimer

The information disclosed to you hereunder (the "Materials") is provided solely for the selection and use of Xilinx products. To the maximum extent permitted by applicable law: (1) Materials are made available "AS IS" and with all faults, Xilinx hereby DISCLAIMS ALL WARRANTIES AND CONDITIONS, EXPRESS, IMPLIED, OR STATUTORY, INCLUDING BUT NOT LIMITED TO WARRANTIES OF MERCHANTABILITY, NON-INFRINGEMENT, OR FITNESS FOR ANY PARTICULAR PURPOSE; and (2) Xilinx shall not be liable (whether in contract or tort, including negligence, or under any other theory of liability) for any loss or damage of any kind or nature related to, arising under, or in connection with, the Materials (including your use of the Materials), including for any direct, indirect, special, incidental, or consequential loss or damage (including loss of data, profits, goodwill, or any type of loss or damage suffered as a result of any action brought by a third party) even if such damage or loss was reasonably foreseeable or Xilinx had been advised of the possibility of the same. Xilinx assumes no obligation to correct any errors contained in the Materials or to notify you of updates to the Materials or to product specifications. You may not reproduce, modify, distribute, or publicly display the Materials without prior written consent. Certain products are subject to the terms and conditions of the Limited Warranties which can be viewed at <http://www.xilinx.com/warranty.htm>; IP cores may be subject to warranty and support terms contained in a license issued to you by Xilinx. Xilinx products are not designed or intended to be fail-safe or for use in any application requiring fail-safe performance; you assume sole risk and liability for use of Xilinx products in Critical Applications: <http://www.xilinx.com/warranty.htm#critapps>.

© Copyright 2011-2012 Xilinx, Inc. Xilinx, the Xilinx logo, Artix, ISE, Kintex, Spartan, Virtex, Vivado, Zynq, and other designated brands included herein are trademarks of Xilinx in the United States and other countries. All other trademarks are the property of their respective owners.