

# **LogiCORE IP Defective Pixel Correction v5.00.a**

## ***Product Guide***

PG005 April 24, 2012

# Table of Contents

---

## Chapter 1: Overview

Feature Summary . . . . .	6
Applications . . . . .	7
Licensing . . . . .	7
Installing Your License File . . . . .	8

---

## Chapter 2: Product Specification

Standards Compliance . . . . .	9
Performance . . . . .	9
Resource Utilization . . . . .	10
Core Interfaces and Register Space . . . . .	12

---

## Chapter 3: Customizing and Generating the Core

Graphical User Interface . . . . .	25
------------------------------------	----

---

## Chapter 4: Designing with the Core

General Design Guidelines . . . . .	30
Clock, Enable, and Reset Considerations . . . . .	31
System Considerations . . . . .	33

---

## Chapter 5: Constraining the Core

Required Constraints . . . . .	35
Device, Package, and Speed Grade Selections . . . . .	35
Clock Frequencies . . . . .	35
Clock Management . . . . .	35
Clock Placement . . . . .	35
Banking . . . . .	35

Transceiver Placement .....	36
I/O Standard and Placement .....	36

---

## Chapter 6: Detailed Example Design

Demonstration Test Bench .....	37
Test Bench Structure .....	37
Running the Simulation .....	38
Directory and File Contents .....	38

---

## Appendix A: Verification, Compliance, and Interoperability

Simulation .....	40
Hardware Testing .....	40
Interoperability .....	41

---

## Appendix B: Migrating

---

## Appendix C: Debugging

Bringing up the AXI4-Lite Interface .....	44
Bringing up the AXI4-Stream Interfaces .....	45
Debugging Features .....	46
Interfacing to Third-Party IP .....	48

---

## Appendix D: Application Software Development

Programmer's Guide .....	49
--------------------------	----

---

## Appendix E: C-Model Reference

Installation and Directory Structure .....	52
Using the C-Model .....	54
Compiling with the DPC C-Model .....	60

---

## Appendix F: Additional Resources

Xilinx Resources .....	61
------------------------	----

<b>Solution Centers</b> .....	<b>61</b>
<b>References</b> .....	<b>61</b>
<b>Technical Support</b> .....	<b>62</b>
<b>Ordering Information</b> .....	<b>62</b>
<b>Revision History</b> .....	<b>62</b>
<b>Notice of Disclaimer</b> .....	<b>63</b>

## Introduction

The Xilinx LogiCORE™ IP Defective Pixel Correction core performs real-time detection and correction of defective pixels in a camera image sensor array.

## Features

- Real-time detection and correction of defective pixels from a camera image sensor array
- Spatial and temporal analysis without using an external frame buffer
- Programmable thresholds for detection/replacement:
  - Spatial variance
  - Temporal variance
  - Pixel age
- Optional AXI4-Lite control interface enables dynamic control of core
- Supports spatial resolutions from 32x32 up to 7680x7680
  - Supports 1080P60 in all supported device families
  - Supports 4kx2k @24Hz in supported high performance devices
- Supports 8, 10 or 12 bits per pixel
- Built in, optional bypass and test pattern generator modes simplifies system debugging
- Built-in optional throughput monitors simplifies system throughput analysis

LogiCORE IP Facts Table	
<b>Core Specifics</b>	
Supported Device Family <sup>(1)</sup>	Zynq 7000, Artix-7, Virtex®-7, Kintex®-7, Virtex-6, Spartan®-6
Supported User Interfaces	AXI4-Lite, AXI4-Stream <sup>(2)</sup>
Resources	See <a href="#">Table 2-1</a> through <a href="#">Table 2-6</a> .
<b>Provided with Core</b>	
Documentation	Product Guide
Design Files	NGC netlist, Encrypted HDL
Example Design	Not Provided
Test Bench	Verilog <sup>(3)</sup>
Constraints File	Not Provided
Simulation Models	VHDL or Verilog Structural, C-Model <sup>(3)</sup>
<b>Tested Design Tools</b>	
Design Entry Tools	CORE Generator™ tool, Platform Studio (XPS)
Simulation <sup>(4)</sup>	Mentor Graphics ModelSim, Xilinx® ISim
Synthesis Tools	Xilinx Synthesis Technology (XST)
<b>Support</b>	
Provided by Xilinx, Inc.	

1. For a complete listing of supported devices, see the [release notes](#) for this core.
2. Video protocol as defined in the *Video IP: AXI Feature Adoption* section of [UG761 AXI Reference Guide](#).
3. HDL test bench and C-Model available on the product page on Xilinx.com at <http://www.xilinx.com/products/intellectual-property/EF-DI-DEF-PIX-CORR.htm>.
4. For the supported versions of the tools, see the [ISE Design Suite 14: Release Notes Guide](#).

## Overview

An image sensor may have a certain number of defective pixels that may be the result of manufacturing faults, failures during normal operation, or variations in pixel voltage levels based on temperature or exposure. A wide class of pixel defects may be characterized as: dead (always low), hot (always high), or stuck (to a certain value). These anomalies can further be characterized as static (always present) or dynamic (as a function of exposure or temperature).

The Xilinx Defective Pixel Correction solution distinguishes between large stationary areas, which are likely to be non-changing parts of the image, and singular outliers, which are likely to be defective pixels. The Xilinx Defective Pixel Correction solution compares a pixel in the raw, Bayer sub-sampled domain to its neighboring, same color pixel values and keeps track of pixels that are sufficiently different from their neighbors. If the values of tracked outlier pixels stay in a predefined range for a predefined number of frames, then the tracked pixels are considered defective, and are replaced with values interpolated from neighboring pixels.

Spatial filtering first identifies potential defective pixels, and at the same time eliminates pixels that blend into their local neighborhoods, and therefore do not need to be substituted even if they are defective. Spatial filtering reduces the number of pixels, along with the amount of information, that needs to be stored for temporal filtering, therefore facilitating spatio-temporal filtering in embedded systems with limited or no access to external memory.

---

## Feature Summary

The Defective Pixel Correction core performs real-time detection and correction of defective pixels in a camera image sensor array. The core is capable of removing defective pixels in real time, without the need to buffer, on a maximum resolution of 7620 columns by 7620 rows 8, 10, or 12 bits per pixel and supports the bandwidth necessary for High-definition (1080p60) resolutions.

You can configure and instantiate the core from CORE Generator or EDK tools. Core functionality may be controlled dynamically with an optional AXI4-Lite interface.

---

## Applications

Detection and correction of noisy or defective pixels for applications utilizing an image sensor with a Bayer pattern Color Filter Array.

---

## Licensing

The Defective Pixel Correction core provides the following three licensing options:

- Simulation Only
- Full System Hardware Evaluation
- Full

After installing the required Xilinx ISE software and IP Service Packs, choose a license option.

### Simulation Only

The Simulation Only Evaluation license key is provided with the Xilinx CORE Generator and EKD tools. This key lets you assess core functionality with either the example design provided with the Defective Pixel Correction core (if provided), or alongside your own design and demonstrates the various interfaces to the core in simulation. (Functional simulation is supported by a dynamically generated HDL structural model.)

No action is required to obtain the Simulation Only Evaluation license key; it is provided by default with the Xilinx CORE Generator and EDK software.

### Full System Hardware Evaluation

The Full System Hardware Evaluation license is available at no cost and lets you fully integrate the core into an FPGA design, place-and-route the design, evaluate timing, and perform functional simulation of the Defective Pixel Correction core using the example design and demonstration test bench provided with the core.

In addition, the license key lets you generate a bitstream from the placed and routed design, which can then be downloaded to a supported device and tested in hardware. The core can be tested in the target device for a limited time before timing out (resetting to default values and the output video becoming black), at which time it can be reactivated by reconfiguring the device.

The timeout period for this core is set to approximately 8 hours for a 74.25 MHz clock. Using a faster or slower clock changes the timeout period proportionally. For example, using a 150 MHz clock results in a timeout period of approximately 4 hours.

To obtain a Full System Hardware Evaluation license, do the following:

1. Navigate to the [product page](#) for this core.
2. Click Evaluate.
3. Follow the instructions to install the required Xilinx ISE software and IP Service Packs.

## Full

The Full license key is available when you purchase the core and provides full access to all core functionality both in simulation and in hardware, including:

- Functional simulation support
- Full implementation support including place and route and bitstream generation
- Full functionality in the programmed device with no time outs

To obtain a Full license key, you must purchase a license for the core. Click on the "Order" link on the Xilinx.com IP core product page for information on purchasing a license for this core. After doing so, click the "How do I generate a license key to activate this core?" link on the Xilinx.com IP core product page for further instructions.

---

## Installing Your License File

The Simulation Only Evaluation license key is provided with the ISE system and does not require installation of an additional license file. For the Full System Hardware Evaluation license and the Full license, an email will be sent to you containing instructions for installing your license file. Additional details about IP license key installation can be found in the ISE Design Suite Installation, Licensing and Release Notes document.



# Product Specification

---

## Standards Compliance

The Defective Pixel Correction core is compliant with the AXI4-Stream Video Protocol and AXI4-Lite interconnect standards. Refer to the *Video IP: AXI Feature Adoption* section of the [UG761 AXI Reference Guide](#) for additional information.

---

## Performance

The following sections detail the performance characteristics of the Defective Pixel Correction core.

### Maximum Frequencies

This section contains typical clock frequencies for the target devices. The maximum achievable clock frequency can vary. The maximum achievable clock frequency and all resource counts can be affected by other tool options, additional logic in the FPGA device, using a different version of Xilinx tools and other factors. Refer to in [Table 2-1](#) through [Table 2-6](#) for device-specific information.

### Latency

The processing latency of the core is shown in the following equation:

$$\text{Latency} = 2 \text{ scan lines} + 18 \text{ pixels}$$

### Throughput

The Defective Pixel Correction core produces one output pixel per input sample.

The core supports bidirectional data throttling between its AXI4-Stream Slave and Master interfaces. If the slave side data source is not providing valid data samples (`s_axis_video_tvalid` is not asserted), the core cannot produce valid output samples

after its internal buffers are depleted. Similarly, if the master side interface is not ready to accept valid data samples (`m_axis_video_tready` is not asserted) the core cannot accept valid input samples once its buffers become full.

If the master interface is able to provide valid samples (`s_axis_video_tvalid` is high) and the slave interface is ready to accept valid samples (`m_axis_video_tready` is high), typically the core can process one sample and produce one pixel per `ACLK` cycle.

However, at the end of each scan line the core flushes internal pipelines for 2 clock cycles, during which the `s_axis_video_tready` is de-asserted signaling that the core is not ready to process samples. Also at the end of each frame the core flushes internal line buffers for 4 scan lines, during which the `s_axis_video_tready` is de-asserted signaling that the core is not ready to process samples.

When the core is processing timed streaming video (which is typical for image sensors), the flushing periods coincide with the blanking periods therefore do not reduce the throughput of the system.

**Note:** There are sections in a video stream that do not contain any video data so the burst rate will always contain video data and the average rate will include the video data and the non-video (blanking) data.

When the core is processing data from a video source which can always provide valid data, e.g. a frame buffer, the throughput of the core can be defined as follows:

$$R_{MAX} = f_{ACLK} \times \frac{ROWS}{ROWS+2} \times \frac{COLS}{COLS+18} \quad \text{Equation 2-1}$$

In numeric terms, 1080P/60 represents an average data rate of 124.4 MPixels/second (1080 rows x 1920 columns x 60 frames / second), and a burst data rate of 148.5 MPixels/sec.

To ensure that the core can process 124.4 MPixels/second, it needs to operate minimally at:

$$f_{ACLK} = R_{MAX} \times \frac{ROWS+2}{ROWS} \times \frac{COLS+18}{COLS} = 124.4 \times \frac{1082}{1080} \times \frac{1938}{1920} = 125.8 \quad \text{Equation 2-2}$$

## Resource Utilization

For an accurate measure of the usage of primitives, slices, and CLBs for a particular instance, check the **Display Core Viewer after Generation** check box in the CORE Generator interface.

The information presented in [Table 2-1](#) through [Table 2-6](#) is a guide to the resource utilization and maximum clock frequency of the Defective Pixel Correction core for all input/output width combinations for Virtex-7, Kintex-7, Artix-7, Zynq-7000, Virtex-6, and Spartan-6 FPGA families. The Xtreme DSP Slice count is always 9, regardless of parameterization, and this core does not use any dedicated I/O or CLK resources. The design was tested using ISE<sup>®</sup> v14.1 tools with default tool options for characterization data.

The design was tested with the AXI4-Lite interface, `INTC_IF` and the Debug Features disabled. By default, the maximum number of pixels per scan line was set to 1920, active pixels per scan line was set to 1920.

**Table 2-1: Spartan-6**

Data Width	LUT-FF Pairs	LUTs	FFs	RAM 16 / 8	DSP48A1	Fmax (MHz)
8	1638	1390	1371	4 / 0	1	184
10	1846	1564	1564	4 / 1	1	164
12	2072	1751	1758	4 / 1	1	175

1. Speedfile: XC6SLX25-2 FGG484 Production 1.21 2012-04-09

**Table 2-2: Virtex-7**

Data Width	LUT-FF Pairs	LUTs	FFs	RAM 36 / 18	DSP48A1	Fmax (MHz)
8	1613	1422	1320	2 / 1	1	253
10	1901	1587	1511	2 / 2	1	232
12	2016	1802	1701	2 / 2	1	253

1. Speedfile: XC7V585T-1 FFG1157 Advanced 1.04k 2012-04-09

**Table 2-3: Virtex-6**

Data Width	LUT-FF Pairs	LUTs	FFs	RAM 36 / 18	DSP48A1	Fmax (MHz)
8	1663	1393	1319	2 / 1	1	255
10	1732	1591	1510	2 / 2	1	285
12	2071	1742	1699	2 / 2	1	255

1. Speedfile: XC6VLX75T-1 FF484 Production 1.17 2012-04-09

**Table 2-4: Kintex-7**

Data Width	LUT-FF Pairs	LUTs	FFs	RAM 36 / 18	DSP48A1	Fmax (MHz)
8	1559	1400	1320	2 / 1	1	288
10	1920	1571	1511	2 / 2	1	280
12	1950	1810	1701	2 / 2	1	272

1. Speedfile: XC7K70T-1 FBG484 Advanced 1.04c 2012-04-09

**Table 2-5: Artix-7**

Data Width	LUT-FF Pairs	LUTs	FFs	RAM 36 / 18	DSP48A1	Fmax (MHz)
8	1691	1437	1319	2 / 1	1	197
10	1923	1616	1510	2 / 2	1	180
12	2026	1793	1699	2 / 2	1	189

1. Speedfile: XC7A100T-1 FGG484 Advanced 1.03k 2012-04-09

Table 2-6: Zynq-7000

Data Width	LUT-FF Pairs	LUTs	FFs	RAM 36 / 18	DSP48A1	Fmax (MHz)
8	1716	1383	1320	2 / 1	1	272
10	1902	1586	1511	2 / 2	1	263
12	2077	1802	1701	2 / 2	1	263

1. Speedfile: XC7Z030-1 FFG676 Advanced 1.01d 2012-04-09

---

## Core Interfaces and Register Space

### Port Descriptions

The Defective Pixel Correction (DPC) core uses industry standard control and data interfaces to connect to other system components. The following sections describe the various interfaces available with the core. [Figure 2-1](#) illustrates an I/O diagram of the DPC core. Some signals are optional and not present for all configurations of the core. The AXI4-Lite interface and the `IRQ` pin are present only when the core is configured via the GUI with an AXI4-Lite control interface. The `INTC_IF` interface is present only when the core is configured via the GUI with the INTC interface enabled.

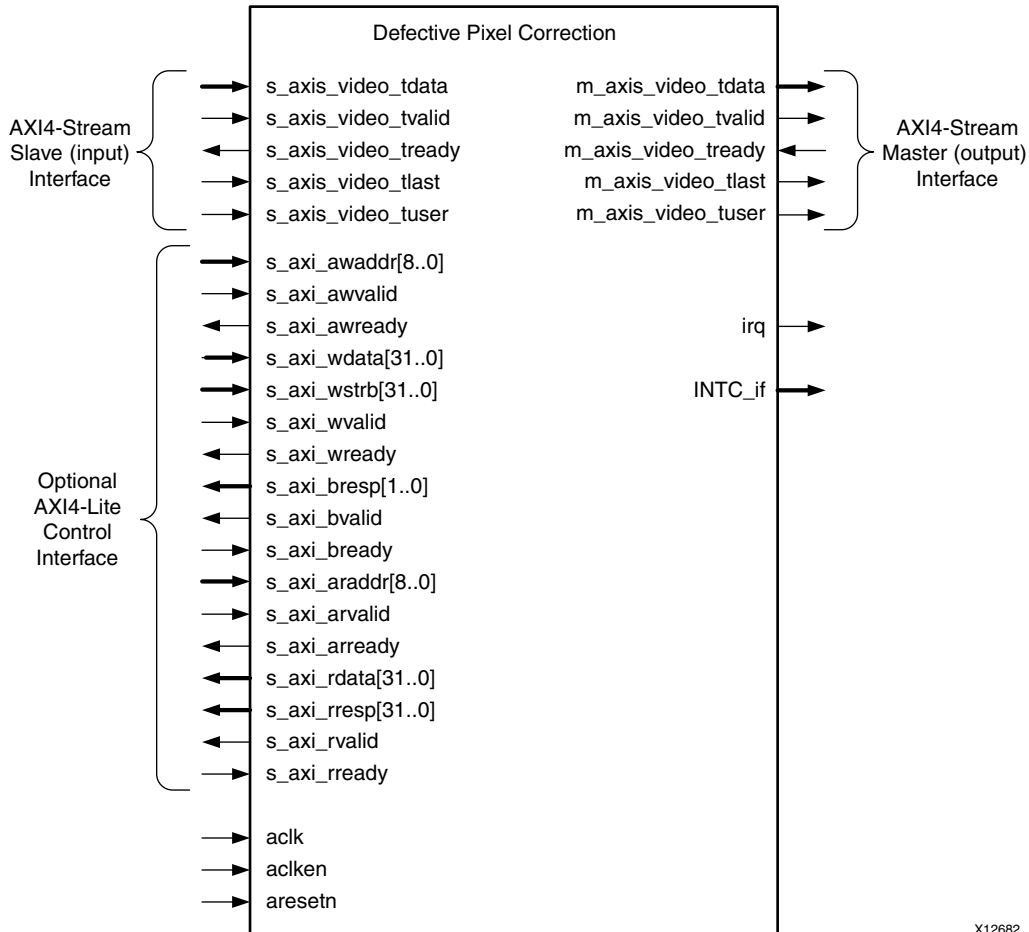

Figure 2-1: DPC Core Top-Level Signaling Interface

## Common Interface Signals

Table 2-7 summarizes the signals which are either shared by, or not part of the dedicated AXI4-Stream data or AXI4-Lite control interfaces.

Table 2-7: Common Interface Signals

Signal Name	Direction	Width	Description
ACLK	In	1	Clock
ACLKEN	In	1	Clock Enable
ARESETn	In	1	Active low synchronous
INTC_IF	Out	6	Optional External Interrupt Controller Interface. Available only when INTC_IF is selected on GUI.
IRQ	Out	1	Optional Interrupt Request Pin. Available only when AXI4-Lite interface is selected on GUI.

The `ACLK`, `ACLKEN` and `ARESETn` signals are shared between the core, the AXI4-Stream data interfaces, and the AXI4-Lite control interface. Refer to [The Interrupt Subsystem](#) for a description of the `INTC_IF` and `IRQ` pins.

## ACLK

All signals, including the AXI4-Stream and AXI4-Lite component interfaces, must be synchronous to the core clock signal `ACLK`. All interface input signals are sampled on the rising edge of `ACLK`. All output signal changes occur after the rising edge of `ACLK`.

## ACLKEN

The `ACLKEN` pin is an active-high, synchronous clock-enable input pertaining to both the AXI4-Stream and AXI4-Lite interfaces. Setting `ACLKEN` low (de-asserted) halts the operation of the core despite rising edges on the `ACLK` pin. Internal states are maintained, and output signal levels are held until `ACLKEN` is asserted again. When `ACLKEN` is de-asserted, core inputs are not sampled, except `ARESETn`, which supersedes `ACLKEN`.

## ARESETn

The `ARESETn` pin is an active-low, synchronous reset input pertaining to both the AXI4-Stream and AXI4-Lite interfaces. `ARESETn` supersedes `ACLKEN`, and when set to 0, the core resets at the next rising edge of `ACLK` even if `ACLKEN` is de-asserted.

## Data Interface

The DPC core receives and transmits data using AXI4-Stream interfaces that implement a video protocol as defined in the *Video IP: AXI Feature Adoption* section of the [UG761 AXI Reference Guide](#).

### AXI4-Stream Signal Names and Descriptions

[Table 2-8](#) describes the AXI4-Stream signal names and descriptions.

**Table 2-8: AXI4-Stream Data Interface Signal Descriptions**

Signal Name	Direction	Width	Description
<code>s_axis_video_tdata</code>	In	8,16	Input Video Data
<code>s_axis_video_tvalid</code>	In	1	Input Video Valid Signal
<code>s_axis_video_tready</code>	Out	1	Input Ready
<code>s_axis_video_tuser</code>	In	1	Input Video Start Of Frame
<code>s_axis_video_tlast</code>	In	1	Input Video End Of Line
<code>m_axis_video_tdata</code>	Out	24,32,40	Output Video Data
<code>m_axis_video_tvalid</code>	Out	1	Output Valid

Table 2-8: AXI4-Stream Data Interface Signal Descriptions

Signal Name	Direction	Width	Description
m_axis_video_tready	In	1	Output Ready
m_axis_video_tuser	Out	1	Output Video Start Of Frame
m_axis_video_tlast	Out	1	Output Video End Of Line

## Video Data

The AXI4-Stream interface specification restricts TDATA widths to integer multiples of 8 bits. Therefore, 10 and 12 bit sensor data must be padded with zeros on the MSB to form a 16 bit wide vector before connecting to s\_axis\_video\_tdata. Padding does not affect the size of the core.

Similarly, RGB data on the DPC output m\_axis\_video\_tdata is packed and padded to multiples of 8 bits as necessary. Zero padding the most significant bits is only necessary for 10 and 12 bit wide data.

## READY/VALID Handshake

A valid transfer occurs whenever READY, VALID, ACLKEN, and ARESETn are high at the rising edge of ACLK, as seen in Figure 2-9. During valid transfers, DATA only carries active video data. Blank periods and ancillary data packets are not transferred via the AXI4-Stream video protocol.

## Guidelines on Driving s\_axis\_video\_tvalid

Once s\_axis\_video\_tvalid is asserted, no interface signals (except the DPC core driving s\_axis\_video\_tready) may change value until the transaction completes (s\_axis\_video\_tready, s\_axis\_video\_tvalid ACLKEN high on the rising edge of ACLK). Once asserted, s\_axis\_video\_tvalid may only be de-asserted after a transaction has completed. Transactions may not be retracted or aborted. In any cycle following a transaction, s\_axis\_video\_tvalid can either be de-asserted or remain asserted to initiate a new transfer.

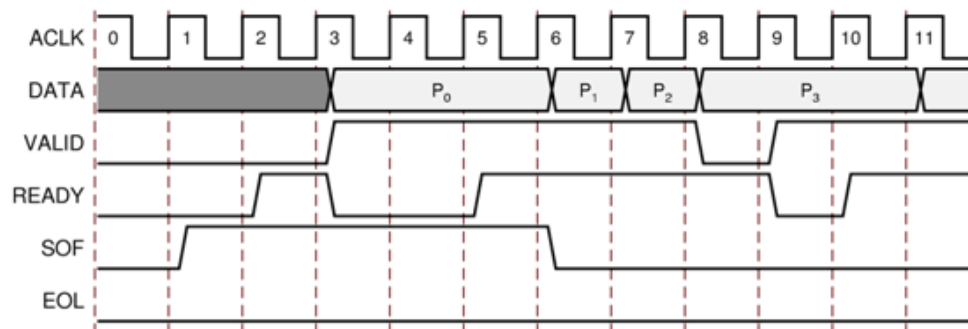

Figure 2-2: Example of READY/VALID Handshake, Start of a New Frame

## Guidelines on Driving m\_axis\_video\_tready

The `m_axis_video_tready` signal may be asserted before, during or after the cycle in which the DPC core asserted `m_axis_video_tvalid`. The assertion of `m_axis_video_tready` may be dependent on the value of `m_axis_video_tvalid`. A slave that can immediately accept data qualified by `m_axis_video_tvalid`, should pre-assert its `m_axis_video_tready` signal until data is received. Alternatively, `m_axis_video_tready` can be registered and driven the cycle following `VALID` assertion. It is recommended that the AXI4-Stream slave should drive `READY` independently, or pre-assert `READY` to minimize latency.

## Start of Frame Signals - m\_axis\_video\_tuser0, s\_axis\_video\_tuser0

The Start-Of-Frame (SOF) signal, physically transmitted over the AXI4-Stream `TUSER0` signal, marks the first pixel of a video frame. The SOF pulse is 1 valid transaction wide, and must coincide with the first pixel of the frame, as seen in Figure 2-2. SOF serves as a frame synchronization signal, which allows downstream cores to re-initialize, and detect the first pixel of a frame. The SOF signal may be asserted an arbitrary number of `ACLK` cycles before the first pixel value is presented on `DATA`, as long as a `VALID` is not asserted.

## End of Line Signals - m\_axis\_video\_tlast, s\_axis\_video\_tlast

The End-Of-Line signal, physically transmitted over the AXI4-Stream `TLAST` signal, marks the last pixel of a line. The EOL pulse is 1 valid transaction wide, and must coincide with the last pixel of a scan-line, as seen in Figure 2-3.

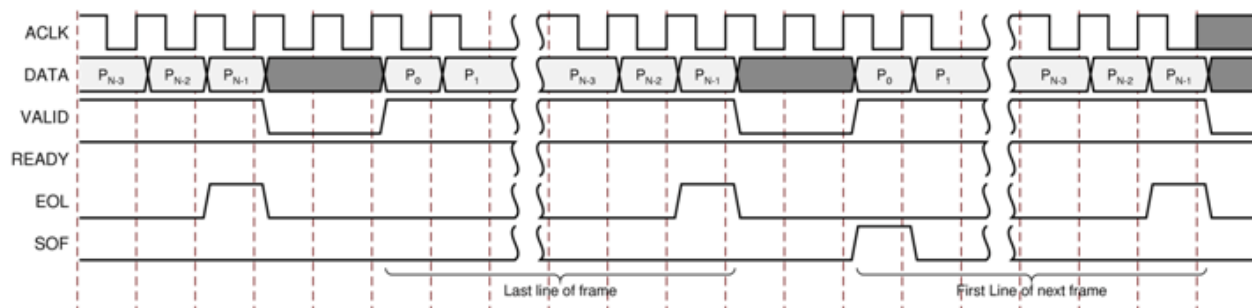

Figure 2-3: Use of EOL and SOF Signals

## Control Interface

When configuring the core, the user has the option to add an AXI4-Lite register interface to dynamically control the behavior of the core. The AXI4-Lite slave interface facilitates integrating the core into a processor system, or along with other video or AXI4-Lite compliant IP, connected via AXI4-Lite interface to an AXI4-Lite master. In a static configuration with a fixed set of parameters (constant configuration), the core can be instantiated without the AXI4-Lite control interface, which reduces the core Slice footprint.



## Constant Configuration

The constant configuration caters to users who will use the DPC core in a single setup that will not need to change. In constant configuration, the image resolution, Spatial Variance Threshold, Temporal Variance Threshold, and Pixel Resolution are hard coded into the core via the DPC core GUI. Since there is no AXI4-Lite interface, the core is not programmable, but can be reset, enabled, or disabled using the `ARESETn` and `ACLKEN` ports.

## AXI4-Lite Interface

The AXI4-Lite interface allows a user to dynamically control parameters within the core. Core configuration can be accomplished using an AXI4-Stream master state machine, or an embedded ARM or soft system processor such as MicroBlaze.

The DPC core can be controlled via the AXI4-Lite interface using read and write transactions to the DPC register space.

**Table 2-9: AXI4-Lite Interface Signals**

Signal Name	Direction	Width	Description
s_axi_lite_awvalid	In	1	AXI4-Lite Write Address Channel Write Address Valid.
s_axi_lite_awread	Out	1	AXI4-Lite Write Address Channel Write Address Ready. Indicates DMA ready to accept the write address.
s_axi_lite_awaddr	In	32	AXI4-Lite Write Address Bus
s_axi_lite_wvalid	In	1	AXI4-Lite Write Data Channel Write Data Valid.
s_axi_lite_wready	Out	1	AXI4-Lite Write Data Channel Write Data Ready. Indicates DMA is ready to accept the write data.
s_axi_lite_wdata	In	32	AXI4-Lite Write Data Bus
s_axi_lite_bresp	Out	2	AXI4-Lite Write Response Channel. Indicates results of the write transfer.
s_axi_lite_bvalid	Out	1	AXI4-Lite Write Response Channel Response Valid. Indicates response is valid.
s_axi_lite_bready	In	1	AXI4-Lite Write Response Channel Ready. Indicates target is ready to receive response.
s_axi_lite_arvalid	In	1	AXI4-Lite Read Address Channel Read Address Valid
s_axi_lite_arready	Out	1	Ready. Indicates DMA is ready to accept the read address.
s_axi_lite_araddr	In	32	AXI4-Lite Read Address Bus
s_axi_lite_rvalid	Out	1	AXI4-Lite Read Data Channel Read Data Valid
s_axi_lite_rready	In	1	AXI4-Lite Read Data Channel Read Data Ready. Indicates target is ready to accept the read data.
s_axi_lite_rdata	Out	32	AXI4-Lite Read Data Bus
s_axi_lite_rresp	Out	2	AXI4-Lite Read Response Channel Response. Indicates results of the read transfer.

## Register Space

The standardized Xilinx Video IP register space is partitioned to control-, timing-, and core specific registers. The DPC core uses only one timing related register, `ACTIVE_SIZE` (0x0020), which allows specifying the input frame dimensions. Also, the core has the following core-specific registers, `THRESH_TEMPORAL_VAR` (0x0100), `THRESH_SPATIAL_VAR` (0x0104), `THRESH_PIXEL_AGE` (0x0108) which allows specifying the characteristics of the defective pixels from the image sensor, as described in `THRESH_TEMPORAL_VAR` (0x0100), `THRESH_SPATIAL_VAR` (0x0104), `THRESH_PIXEL_AGE` (0x0108) registers.

Table 2-10: Register Names and Descriptions

Address (hex) BASEADDR +	Register Name	Access Type	Double Buffered	Default Value	Register Description
0x0000	CONTROL	R/W	N	Power-on-Reset : 0x0	Bit 0: SW_ENABLE Bit 1: REG_UPDATE Bit 4: BYPASS <sup>(1)</sup> Bit 5: TEST_PATTERN <sup>(1)</sup> Bit 30: FRAME_SYNC_RESET (1: reset) Bit 31: SW_RESET (1: reset)
0x0004	STATUS	R/W	No	0	Bit 0: PROC_STARTED Bit 1: EOF Bit 16: SLAVE_ERROR
0x0008	ERROR	R/W	No	0	Bit 0: SLAVE_EOL_EARLY Bit 1: SLAVE_EOL_LATE Bit 2: SLAVE_SOF_EARLY Bit 3: SLAVE_SOF_LATE
0x000C	IRQ_ENABLE	R/W	No	0	16-0: Interrupt enable bits corresponding to STATUS bits
0x0010	VERSION	R	N/A	0x0500a000	7-0: REVISION_NUMBER 11-8: PATCH_ID 15-12: VERSION_REVISION 23-16: VERSION_MINOR 31-24: VERSION_MAJOR
0x0014	SYSDEBUG0	R	N/A	0	31-0: Frame Throughput monitor <sup>(1)</sup>
0x0018	SYSDEBUG1	R	N/A	0	31-0: Line Throughput monitor <sup>(1)</sup>
0x001C	SYSDEBUG2	R	N/A	0	31-0: Pixel Throughput monitor <sup>(1)</sup>
0x0020	ACTIVE_SIZE	R/W	Yes	Specified via GUI	12-0: Number of Active Pixels per Scanline 28-16: Number of Active Lines per Frame
0x0100	THRESH_TEMPORAL_VAR	R/W	Yes	Specified via GUI	11-0: Allowed inter-frame variance of defective pixels beyond which the pixel is characterized as an outlier

Table 2-10: Register Names and Descriptions (Cont'd)

Address (hex) BASEADDR +	Register Name	Access Type	Double Buffered	Default Value	Register Description
0x0104	THRESH_SPATIAL_V AR	R/W	Yes	Specified via GUI	15-0: Allowed spatial variance of defective pixels beyond which the pixel is characterized as an outlier
0x0108	THRESH_PIXEL_AGE	R/W	Yes	Specified via GUI	15-0: Number of frames an outlier pixel has to keep its value within the range specified by THRESH_TEMPORAL_VAR before the pixel is interpolated.
0x010C	NUM_CANDIDATES	R	No	0	31-0: Total number of potential defective pixel candidates stored in FIFO from the previous frame.
0x0120	NUM_DEFECTIVE	R	No	0	31-0: Total number of pixels being actively interpolated in previous frame.

1. Only available when the debugging features option is enabled in the GUI at the time the core is instantiated.

### CONTROL (0x0000) Register

Bit 0 of the CONTROL register, SW\_ENABLE, facilitates enabling and disabling the core from software. Writing '0' to this bit effectively disables the core halting further operations, which blocks the propagation of all video signals. The default value of SW enable is 1 (enabled) for the Constant configuration. After Power up, or Global Reset, the SW\_ENABLE defaults to 0 for the AXI4-Lite interface. Similar to the ACLKEN pin, the SW\_ENABLE flag is not synchronized with the AXI4-Stream interfaces: Enabling or Disabling the core takes effect immediately, irrespective of the core processing status. Disabling the core for extended periods may lead to image tearing.

Bit 1 of the CONTROL register, REG\_UPDATE is a write done semaphore for the host processor, which facilitates committing all user and timing register updates simultaneously. The DPC core ACTIVE\_SIZE and BAYER\_PHASE registers are double buffered. One set of registers (the processor registers) is directly accessed by the processor interface, while the other set (the active set) is actively used by the core. New values written to the processor registers will get copied over to the active set at the end of the AXI4-Stream frame, if and only if REG\_UPDATE is set. Setting REG\_UPDATE to 0 before updating multiple register values, then setting REG\_UPDATE to 1 when updates are completed ensures all registers are updated simultaneously at the frame boundary without causing image tearing.

Bit 4 of the CONTROL register, BYPASS, switches the core to bypass mode if debug features are enabled. In bypass mode the DPC core processing function is bypassed, and the core repeats AXI4-Stream input samples on its output. Refer to [Debugging Features in Appendix C](#) for more information. If debug features were not included at instantiation, this flag has no effect on the operation of the core. Switching bypass mode on or off is not synchronized to frame processing, therefore can lead to image tearing.

Bit 5 of the `CONTROL` register, `TEST_PATTERN`, switches the core to test-pattern generator mode if debug features are enabled. Refer to [Debugging Features in Appendix C](#) for more information. If debug features were not included at instantiation, this flag has no effect on the operation of the core. Switching test-pattern generator mode on or off is not synchronized to frame processing, therefore can lead to image tearing.

Bits 30 and 31 of the `CONTROL` register, `FRAME_SYNC_RESET` and `SW_RESET` facilitate software reset. Setting `SW_RESET` reinitializes the core to GUI default values, all internal registers and outputs are cleared and held at initial values until `SW_RESET` is set to 0. The `SW_RESET` flag is not synchronized with the AXI4-Stream interfaces. Resetting the core while frame processing is in progress will cause image tearing. For applications where the soft-ware reset functionality is desirable, but image tearing has to be avoided a frame synchronized software reset (`FRAME_SYNC_RESET`) is available. Setting `FRAME_SYNC_RESET` to 1 will reset the core at the end of the frame being processed, or immediately if the core is between frames when the `FRAME_SYNC_RESET` was asserted. After reset, the `FRAME_SYNC_RESET` bit is automatically cleared, so the core can get ready to process the next frame of video as soon as possible. The default value of both `RESET` bits is 0. Core instances with no AXI4-Lite control interface can only be reset via the `ARESETn` pin.

## STATUS (0x0004) Register

All bits of the `STATUS` register can be used to request an interrupt from the host processor. To facilitate identification of the interrupt source, bits of the `STATUS` register remain set after an event associated with the particular `STATUS` register bit, even if the event condition is not present at the time the interrupt is serviced.

Bits of the `STATUS` register can be cleared individually by writing '1' to the bit position to be cleared.

Bit 0 of the `STATUS` register, `PROC_STARTED`, indicates that processing of a frame has commenced via the AXI4-Stream interface.

Bit 1 of the `STATUS` register, End-of-frame (EOF), indicates that the processing of a frame has completed.

Bit 16 of the `STATUS` register, `SLAVE_ERROR`, indicates that one of the conditions monitored by the `ERROR` register has occurred.

## ERROR (0x0008) Register

Bit 16 of the `STATUS` register, `SLAVE_ERROR`, indicates that one of the conditions monitored by the `ERROR` register has occurred. This bit can be used to request an interrupt from the host processor. To facilitate identification of the interrupt source, bits of the `STATUS` and `ERROR` registers remain set after an event associated with the particular `ERROR` register bit, even if the event condition is not present at the time the interrupt is serviced.

Bits of the `ERROR` register can be cleared individually by writing '1' to the bit position to be cleared.

Bit 0 of the `ERROR` register, `EOL_EARLY`, indicates an error during processing a video frame via the AXI4-Stream slave port. The number of pixels received between the latest and the preceding End-Of-Line (`EOL`) signal was less than the value programmed into the `ACTIVE_SIZE` register.

Bit 1 of the `ERROR` register, `EOL_LATE`, indicates an error during processing a video frame via the AXI4-Stream slave port. The number of pixels received between the last `EOL` signal surpassed the value programmed into the `ACTIVE_SIZE` register.

Bit 2 of the `ERROR` register, `SOF_EARLY`, indicates an error during processing a video frame via the AXI4-Stream slave port. The number of pixels received between the latest and the preceding Start-Of-Frame (`SOF`) signal was less than the value programmed into the `ACTIVE_SIZE` register.

Bit 3 of the `ERROR` register, `SOF_LATE`, indicates an error during processing a video frame via the AXI4-Stream slave port. The number of pixels received between the last `SOF` signal surpassed the value programmed into the `ACTIVE_SIZE` register.

### **IRQ\_ENABLE (0x000C) Register**

Any bits of the `STATUS` register can generate a host-processor interrupt request via the `IRQ` pin. The Interrupt Enable register facilitates selecting which bits of `STATUS` register will assert `IRQ`. Bits of the `STATUS` registers are masked by (AND) corresponding bits of the `IRQ_ENABLE` register and the resulting terms are combined (OR) together to generate `IRQ`.

### **Version (0x0010) Register**

Bit fields of the Version Register facilitate software identification of the exact version of the hardware peripheral incorporated into a system. The core driver can take advantage of this Read-Only value to verify that the software is matched to the correct version of the hardware.

### **SYSDEBUG0 (0x0014) Register**

The `SYSDEBUG0`, or Frame Throughput Monitor, register indicates the number of frames processed since power-up or the last time the core was reset. The `SYSDEBUG` registers can be useful to identify external memory / Frame buffer / or throughput bottlenecks in a video system. Refer to [Debugging Features in Appendix C](#) for more information.

### **SYSDEBUG1 (0x0018) Register**

The `SYSDEBUG1`, or Line Throughput Monitor, register indicates the number of lines processed since power-up or the last time the core was reset. The `SYSDEBUG` registers can be useful to identify external memory / Frame buffer / or throughput bottlenecks in a video

system. Refer to [Debugging Features in Appendix C](#) for more information.

### **SYSDEBUG2 (0x001C) Register**

The `SYSDEBUG2`, or Pixel Throughput Monitor, register indicates the number of pixels processed since power-up or the last time the core was reset. The `SYSDEBUG` registers can be useful to identify external memory / Frame buffer / or throughput bottlenecks in a video system. Refer to [Debugging Features in Appendix C](#) for more information.

### **ACTIVE\_SIZE (0x0020) Register**

The `ACTIVE_SIZE` register encodes the number of active pixels per scan line and the number of active scan lines per frame. The lower half-word (bits 12:0) encodes the number of active pixels per scan line. Supported values are between 32 and the value provided in the **Maximum number of pixels per scan line** field in the GUI. The upper half-word (bits 28:16) encodes the number of active lines per frame. Supported values are 32 to 7680. To avoid processing errors, the user should restrict values written to `ACTIVE_SIZE` to the range supported by the core instance.

### **THRESH\_TEMPORAL\_VAR (0x0100) Register**

Threshold value `THRESH_TEMPORAL_VAR`, defines the range a pixel value needs to stay in to be classified as stuck. The lower the value, the lower the chance that slowly varying pixels get characterized as stuck. However, if the sensor image is loaded with noise, or blooming may modify the readout values of dead pixels, `THRESH_TEMPORAL_VAR` may need to be increased to identify all stuck pixels. As a practical value for `THRESH_TEMPORAL_VAR`, the square root of the maximum pixel value is suggested.

### **THRESH\_SPATIAL\_VAR (0x0104) Register**

Threshold value `THRESH_SPATIAL_VAR` defines how different a pixel needs to be from the surrounding pixels to be classified as an outlier. A practical value of  $2^{\text{DATA\_WIDTH}-5}$  identifies pixels that visually stand out from their surroundings. A higher threshold value for `THRESH_SPATIAL_VAR` results in a lower number of outlier candidates and slower convergence time for identifying all outliers, but at the same time returns fewer false positives. If heuristics for the total number of outliers ( $M$ ) are known, a feedback mechanism can be implemented that tunes `THRESH_SPATIAL_VAR` so that the number of outlier pixels identified, `num_candidates`, approximates  $M$ .

### **THRESH\_PIXEL\_AGE (0x0108) Register**

Threshold value, `THRESH_PIXEL_AGE`, defines the number of frames presumed outliers have to hold their values within `THRESH_TEMPORAL_VAR` range before an outlier pixel is considered defective, and replacement (interpolation) of the pixels begin. The higher the value of `THRESH_PIXEL_AGE`, the less flickering due to incorrect defective pixel correction the algorithm produces, but also the longer it takes for the algorithm to converge and start

replacing defective pixels. Values in the range of several thousands allow virtually no flickering while identifying outliers within minutes.

### NUM\_CANDIDATES (0x010C) Register

This read only register returns the number of potential defective pixel candidates stored in memory from the previous frame.

### NUM\_DEFECTIVE (0x0120) Register

This read only register returns the number of pixels actively being interpolated from the previous frame.

## The Interrupt Subsystem

`STATUS` register bits can trigger interrupts so embedded application developers can quickly identify faulty interfaces or incorrectly parameterized cores in a video system. Irrespective of whether the AXI4-Lite control interface is present or not, the DPC core detects AXI4-Stream framing errors, as well as the beginning and the end of frame processing.

When the core is instantiated with an AXI4-Lite Control interface, the optional interrupt request pin (`IRQ`) is present. Events associated with bits of the `STATUS` register can generate a (level triggered) interrupt, if the corresponding bits of the interrupt enable register (`IRQ_ENABLE`) are set. Once set by the corresponding event, bits of the `STATUS` register stay set until the user application clears them by writing '1' to the desired bit positions. Using this mechanism the system processor can identify and clear the interrupt source.

Without the AXI4-Lite interface the user can still benefit from the core signaling error and status events. By selecting the **Enable INTC Port** check-box on the GUI, the core generates the optional `INTC_IF` port. This vector of signals gives parallel access to the individual interrupt sources, as seen in [Table 2-11](#).

Unlike `STATUS` and `ERROR` flags, `INTC_IF` signals are not held, rather stay asserted only while the corresponding event persists.

*Table 2-11: INTC\_IF Signal Functions*

INTC_IF signal	Function
0	Frame processing start
1	Frame processing complete
2	Reserved
3	Reserved
4	Video over AXI4-Stream Error
5	EOL Early

Table 2-11: INTC\_IF Signal Functions

INTC_IF signal	Function
6	EOL Late
7	SOF Early
8	SOF Late

In a system integration tool, such as EDK, the interrupt controller INTC IP can be used to register the selected `INTC_IF` signals as edge triggered interrupt sources. The INTC IP provides functionality to mask (enable or disable), as well as identify individual interrupt sources from software. Alternatively, for an external processor or MCU the user can custom build a priority interrupt controller to aggregate interrupt requests and identify interrupt sources.



# Customizing and Generating the Core

This chapter includes information on using Xilinx tools to customize and generate the core.

## Graphical User Interface

The Defective Pixel Correction core is easily configured to meet developers' specific needs before instantiation through the CORE Generator™ or EDK graphical user interface (GUI). Once developers start to build the Defective Pixel Correction core, they are guided through and asked to set various parameters. This section provides a quick reference to the windows and parameters that can be configured at compile time.

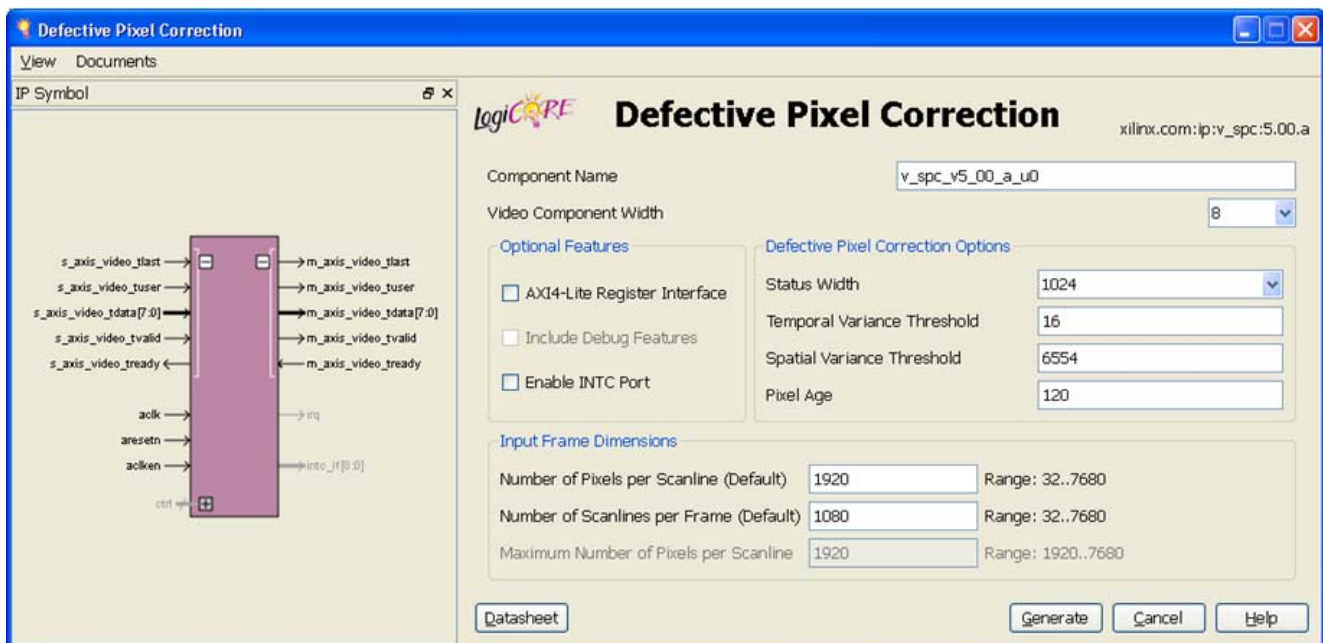

Figure 3-1: Graphical User Interface – Screen 1

The first screen (Figure 3-1) for CORE Generator shows a representation of the IP symbol on the left side, and the settable parameters on the right, which are described as follows:

- **Component Name:** The component name is used as the base name of output files generated for the module. Names must begin with a letter and must be composed

from characters: a to z, 0 to 9 and "\_". The name v\_spc\_v5\_00\_a cannot be used as a component name.

- **Video Component Width:** Specifies the bit width of the input channel. Permitted values are 8, 10, and 12.
- **Optional Features:**
  - **AXI4-Lite Register Interface:** When selected, the core will be generated with an AXI4-Lite interface, which gives access to dynamically program and change processing parameters. For more information, refer to Control Interface in Chapter 2.
  - **Include Debug Features:** When selected, the core will be generated with debugging features, which simplify system design, testing and debugging. For more information, refer to Debugging Features in Appendix C.

**Note:** Note: Debugging features are only available when the AXI4-Lite Register Interface is selected.
  - **Enable INTC Port:** When selected, the core will generate the optional `INTC_IF` port, which gives parallel access to signals indicating frame processing status and error conditions. For more information, refer to The Interrupt Subsystem in Chapter 2.
- **Defective Pixels Tracked:** This option specifies the maximum number of potential defective pixels. Candidate defective pixels will be stored in Block RAMs.
- **Temporal Variance Threshold:** This option defines the range a pixel value needs to stay in to be classified as stuck. The lower the value, the lower the chance that slowly varying pixels get characterized as stuck. However, if the sensor image is loaded with noise, or blooming may modify the readout values of dead pixels, this option may need to be increased to identify all stuck pixels. As a practical value, the square root of the maximum pixel value is suggested.
- **Spatial Variance Threshold:** Spatial Variance Threshold defines how different a pixel needs to be from the surrounding pixels to be classified as an outlier. A practical value of  $2^{\text{DATA\_WIDTH}-5}$  identifies pixels that visually stand out from their surroundings. A higher threshold value results in a lower number of outlier candidates and slower convergence time for identifying all outliers, but at the same time returns fewer false positives. If heuristics for the total number of outliers (M) are known, a feedback mechanism can be implemented that tunes the threshold so that the number of outlier pixels identified, `NUM_CANDIDATES`, approximates M.
- **Pixel Age:** This option defines the number of frames presumed outliers have to hold their values within Temporal Threshold Variance range before an outlier pixel is considered defective, and replacement (interpolation) of the pixels begin. The higher the Pixel Age value, the less flickering due to incorrect defective pixel correction the algorithm produces, but also the longer it takes for the algorithm to converge and start replacing defective pixels. Values in the range of several thousands allow virtually no flickering while identifying outliers within minutes.

- **Input Frame Dimensions:**
  - **Number of Active Pixels per Scan line:** When the AXI4-Lite control interface is enabled, the generated core will use the value specified in the CORE Generator GUI as the default value for the lower half-word of the `ACTIVE_SIZE` register. When an AXI4-Lite interface is not present, the GUI selection permanently defines the horizontal size of the frames the generated core instance is to process.
  - **Number of Active Lines per Frame:** When the AXI4-Lite control interface is enabled, the generated core will use the value specified in the CORE Generator GUI as the default value for the upper half-word of the `ACTIVE_SIZE` register. When an AXI4-Lite interface is not present, the GUI selection permanently defines the vertical size (number of lines) of the frames the generated core instance is to process.
  - **Maximum Number of Active Pixels Per Scan line:** Specifies the maximum number of pixels per scan line that can be processed by the generated core instance. Permitted values are from 32 to 7680. Specifying this value is necessary to establish the depth of line buffers. The actual value selected for Number of Active Pixels per Scan line, or the corresponding lower half-word of the `ACTIVE_SIZE` register must always be less than the value provided by Maximum Number of Active Pixels Per Scan line. Using a tight upper-bound results in optimal block RAM usage. This field is enabled only when the AXI4-Lite interface is selected. Otherwise contents of the field are reflecting the actual contents of the **Number of Active Pixels per Scan line** field as for constant mode the maximum number of pixels equals the active number of pixels.

Figure 3-2 shows the EDK GUI. Definitions of the EDK GUI controls are identical to the corresponding CORE Generator GUI functions.

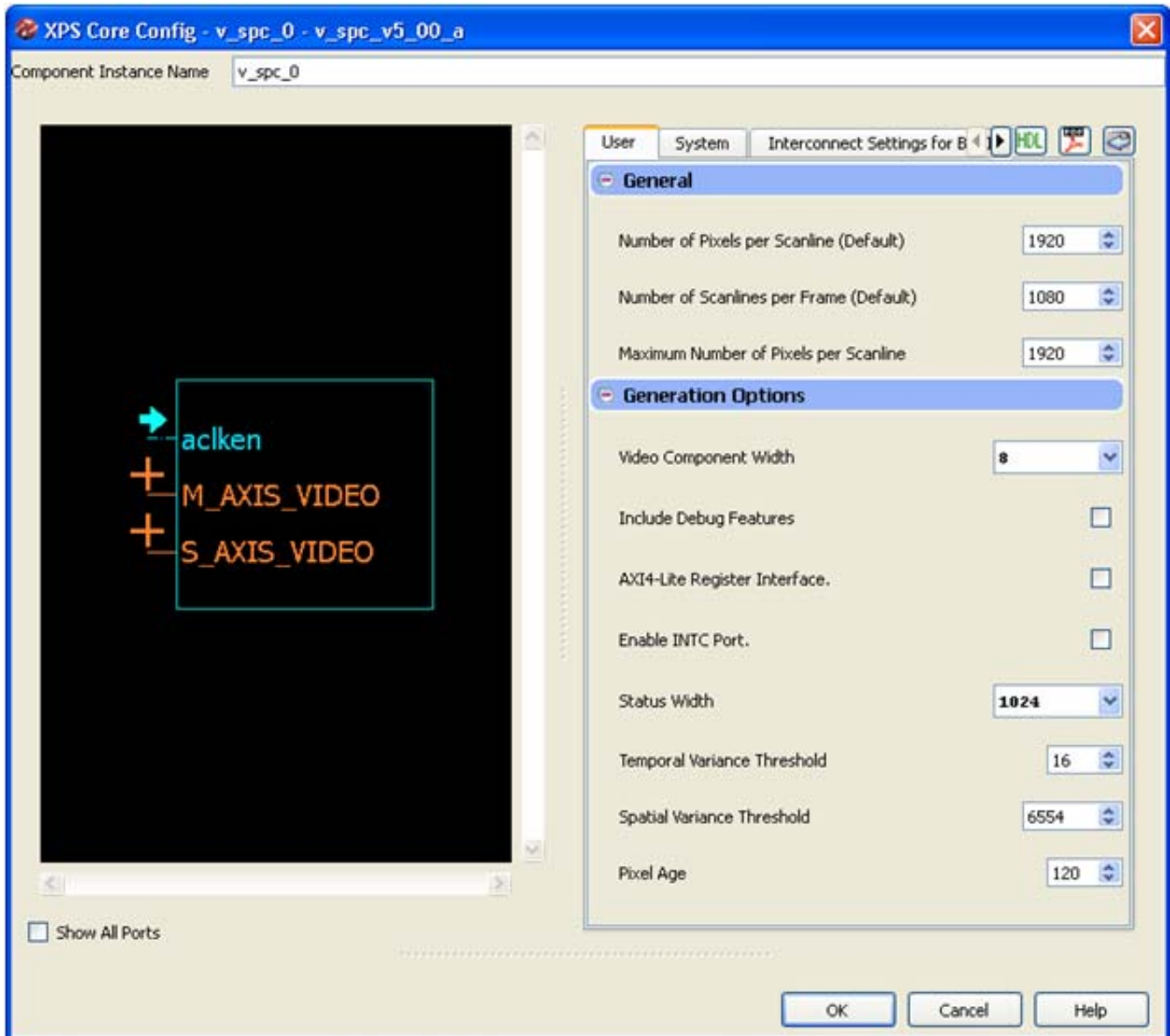

Figure 3-2: EDK Graphical User Interface

## Parameter Values in the XCO File

Table 3-1 defines valid entries for the XCO parameters. Xilinx strongly suggests that XCO parameters are not manually edited in the XCO file; instead, use the CORE Generator software GUI to configure the core and perform range and parameter value checking. The XCO parameters are helpful in defining the interface to other Xilinx tools.

Table 3-1: XCO Parameters

XCO Parameter	Default Value
active_cols	1920
active_rows	1080
component_name	v_spc_v5_00_a_u0
data_width	8
has_axi4_lite	false
has_debug	false
has_intc_if	false
max_cols	1920
status_width	1024
thresh_pixel_age	120
thresh_spatial_var	6554
thresh_temporal_var	16

## Output Generation

CORE Generator will output the core as a netlist that can be inserted into a processor interface wrapper or instantiated directly in an HDL design. The output is placed in the <project director>.

## File Details

The CORE Generator output consists of some or all the following files in [Table 3-2](#).

Table 3-2: CORE Generator Output Files

Name	Description
<component_name>_readme.txt	Readme file for the core.
<component_name>.ngc	The netlist for the core.
<component_name>.veo	The HDL template for instantiating the core.
<component_name>.vho	
<component_name>.v	The structural simulation model for the core. It is used for functionally simulating the core.
<component_name>.vhd	
<component_name>.xco	Log file from CORE Generator software describing which options were used to generate the core. An XCO file can also be used as an input to the CORE Generator software.

# Designing with the Core

## General Design Guidelines

The DPC core corrects defective pixels from a Bayer sub-sampled image sensor data to downstream processing modules. The resulting video stream remains Bayer sub-sampled.

The core processes samples provided via an AXI4-Stream slave interface, outputs pixels via an AXI4-Stream master interface, and can be controlled via an optional AXI4-Lite interface. It is recommended that the DPC core is used in conjunction with the Video In to AXI4-Stream and Video Timing Controller cores. The Video Timing Controller core measures the timing parameters, such as number of active scan lines, number of active pixels per scan line of the image sensor. The Video In to AXI4-Stream core formats the input video to the AXI4-Stream interface.

Typically, the DPC core is part of an Image Sensor Pipeline (ISP) System, as shown in Figure 4-1.

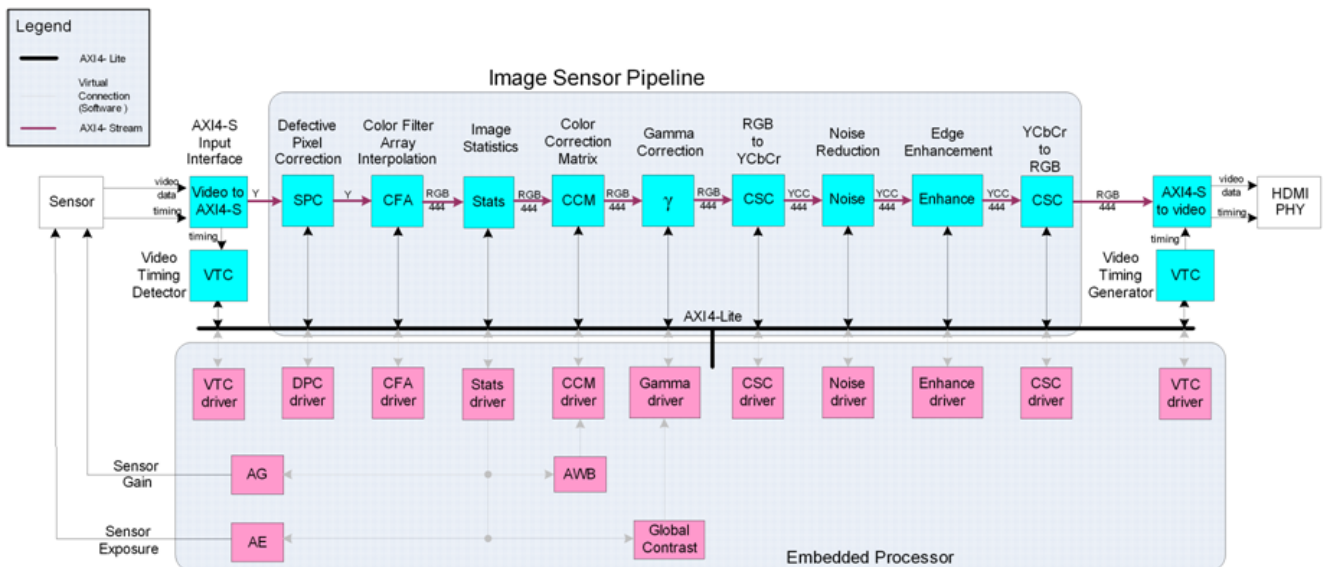

Figure 4-1: Image Sensor Pipeline System with DPC Core

# Clock, Enable, and Reset Considerations

## ACLK

The master and slave AXI4-Stream video interfaces use the `ACLK` clock signal as their shared clock reference, as shown in Figure 4-2.

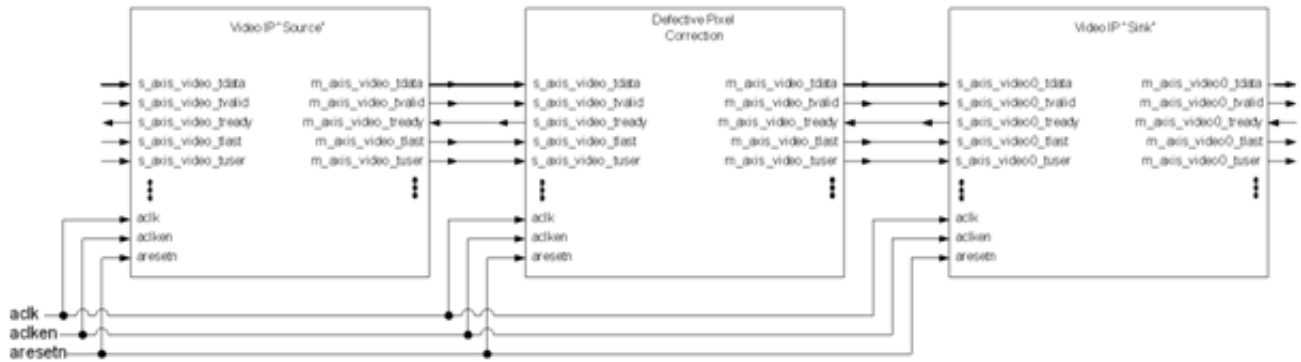

Figure 4-2: Example of ACLK Routing in an ISP Processing Pipeline

The `ACLK` pin is also shared between the AXI4-Lite and AXI4-Stream interfaces, the DPC core does not contain optional clock-domain crossing logic. If in the user system the AXI4-Lite Control interface clock (`CLK_LITE`) is different from the AXI4-Stream clock (`CLK_STREAM`), and

- ( $F_{CLK\_STREAM} > F_{CLK\_LITE}$ ) then clock-domain crossing logic needs to be inserted in front of the AXI4-Lite Control interface and the DPC core can be clocked at the AXI4-Stream clock via `ACLK`.

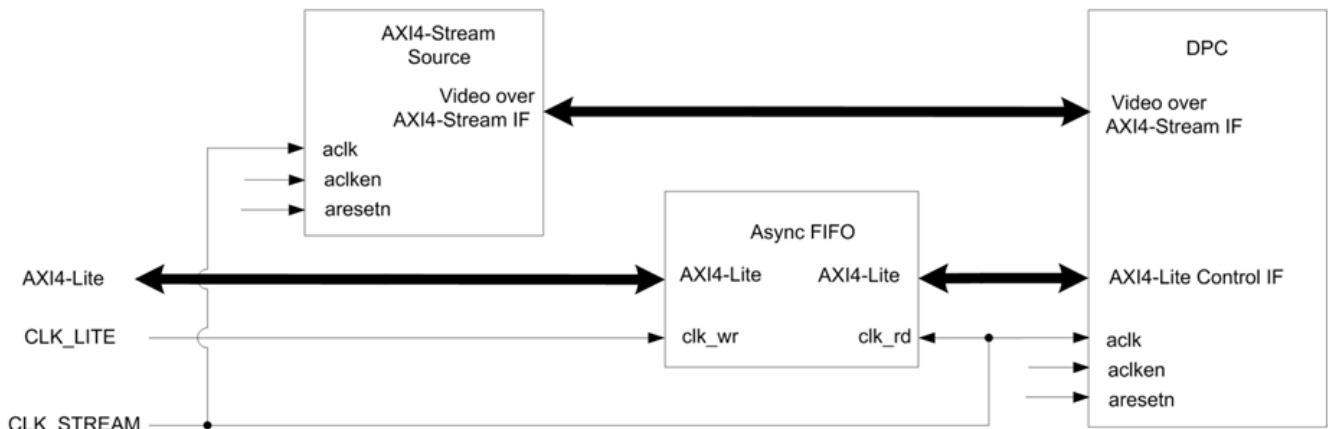

Figure 4-3: Example of ACLK Routing in an ISP Processing Pipeline

- ( $F_{CLK\_STREAM} < F_{CLK\_LITE}$ ) then clock-domain crossing logic needs to be inserted before the AXI4-Stream interface, and the DPC core needs to be clocked at the AXI4-Lite clock via the `ACLK` pin, as shown in Figure 4-4. Alternatively, if  $F_{CLK\_LITE}$  greater than of the  $F_{MAX}$  of the DPC core, clock domain crossing logic can be inserted in front of the AXI4-Lite Control interface.

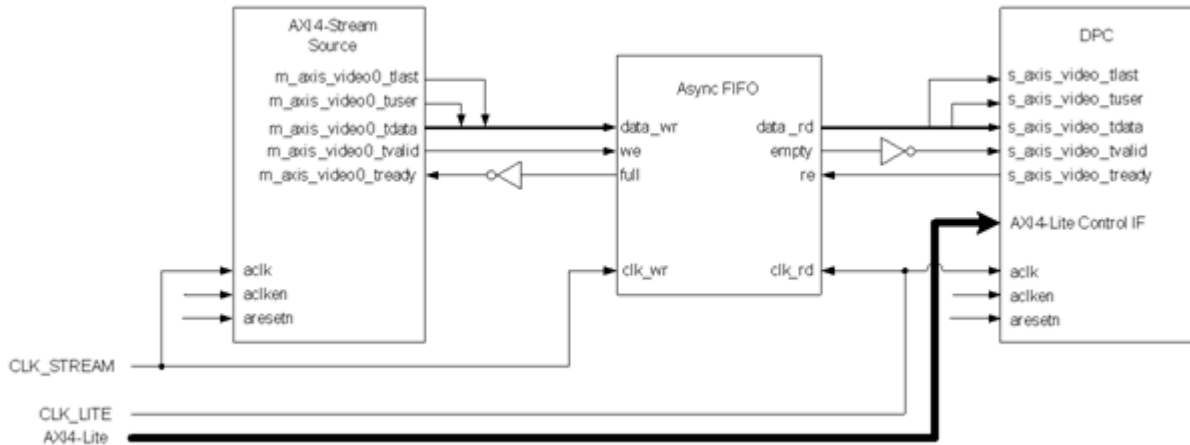

Figure 4-4: DPC CORE Top-Level Signaling Interface

In either case, Xilinx System Integrator tools, such as EDK, can automatically infer clock-domain crossing logic using the AXI interconnect core, when the tool detects that the master / slave side of AXI4 interfaces operate on different CLK rates. For manual instantiation of clock-domain crossing logic, HDL users can take advantage of the FIFO Generator IP core, as shown in Figure 4-4.

## ACLKEN

The DPC core has two enable options: the `ACLKEN` pin (hardware clock enable), and the software reset option provided via the AXI4-Lite control interface (when present).

`ACLKEN` is by no means synchronized internally to AXI4-Stream frame processing therefore de-asserting `ACLKEN` for extended periods of time may lead to image tearing.

The `ACLKEN` pin facilitates:

- Multi-cycle path designs (high speed clock division without clock gating),
- Standby operation of subsystems to save on power
- Hardware controlled bring-up of system components

**Note:** When `ACLKEN` (clock enable) pins are used (toggled) in conjunction with a common clock source driving the master and slave sides of an AXI4-Stream interface, to prevent transaction errors the `ACLKEN` pins associated with the master and slave component interfaces must also be driven by the same signal (Figure 2-2).



**Note:** When two cores connected via AXI4-Stream interfaces, where only the master or the slave interface has an `ACLKEN` port, which is not permanently tied high, the two interfaces should be connected via the AXI4-Stream Interconnect or AXI-FIFO cores to avoid data corruption (Figure 2-3).

## ARESETn

The DPC core has two reset source: the `ARESETn` pin (hardware reset), and the software reset option provided via the AXI4-Lite control interface (when present).

**Note:** `ARESETn` is by no means synchronized internally to AXI4-Stream frame processing, therefore de-asserting `ARESETn` while a frame is being process will lead to image tearing.

The external reset pulse needs to be held for 32 `ACLK` cycles to reset the core.

**Note:** When a system with multiple-clocks and corresponding reset signals are being reset, the reset generator has to ensure all reset signals are asserted/de-asserted long enough that all interfaces and clock-domains in all IP cores are correctly reinitialized.

---

## System Considerations

When using the DPC, it needs to be configured for the actual video frame-size to operate properly. To gather the frame size information from the video, it can be connected to the Video In to AXI4-Stream input and the Video Timing Controller. The timing detector logic in the Video Timing Controller will gather the video timing signals. The AXI4-Lite control interface on the Video Timing Controller allows the system processor to read out the measured frame dimensions, and program all downstream cores, such as the DPC, with the appropriate image dimensions.

If the target system will use only one setup of the DPC, the user may choose to create a constant configuration by removing the AXI4-Lite interface. This option allows reducing the core Slice footprint.

## Programming Sequence

If processing parameters such as the image size needs to be changed on the fly, or the system needs to be reinitialized, it is recommended that pipelined Xilinx IP video cores are disabled/reset from system output towards the system input, and programmed/enabled from system input to system output. `STATUS` register bits allow system processors to identify the processing states of individual constituent cores, and successively disable a pipeline as one core after another is finished processing the last frame of data.

## Error Propagation and Recovery

Parameterization and/or configuration registers define the dimensions of video frames video IP should process. Starting from a known state, based on these configuration settings

the IP can predict when the beginning of the next frame is expected. Similarly, the IP can predict when the last pixel of each scan line is expected. SOF detected before it was expected (early), or SOF not present when it is expected (late), EOL detected before expected (early), or EOL not present when expected (late), signals error conditions indicative of either upstream communication errors or incorrect core configuration.

When SOF is detected early, the output SOF signal is generated early, terminating the previous frame immediately. When SOF is detected late, the output SOF signal is generated according to the programmed values. Extra lines / pixels from the previous frame are dropped until the input SOF is captured.

Similarly, when EOL is detected early, the output EOL signal is generated early, terminating the previous line immediately. When EOL is detected late, the output EOL signal is generated according to the programmed values. Extra pixels from the previous line are dropped until the input EOL is captured.

# Constraining the Core

---

## Required Constraints

The `ACLK` pin should be constrained at the pixel clock rate desired for your video stream.

---

## Device, Package, and Speed Grade Selections

There are no device, package, or speed grade requirements for this core. For a complete listing of supported devices, see the [release notes](#) for this core.

---

## Clock Frequencies

The pixel clock frequency is the required frequency for this core. See [Maximum Frequencies in Chapter 2](#).

---

## Clock Management

There is only one clock for this core.

---

## Clock Placement

There are no specific Clock placement requirements for this core.

---

## Banking

There are no specific Banking rules for this core.

---

## Transceiver Placement

There are no Transceiver Placement requirements for this core.

---

## I/O Standard and Placement

There are no specific I/O standards and placement requirements for this core.

# Detailed Example Design

No example design is available at the time for the LogiCORE IP Defective Pixel Correction v5.00.a core.

---

## Demonstration Test Bench

A demonstration test bench is provided which enables core users to observe core behavior in a typical use scenario. The user is encouraged to make simple modifications to the test conditions and observe the changes in the waveform.

---

## Test Bench Structure

The top-level entity, `tb_main.v`, instantiates the following modules:

- DUT  
The DPC core instance under test.
- axi4lite\_mst  
The AXI4-Lite master module, which initiates AXI4-Lite transactions to program core registers.
- axi4s\_video\_mst  
The AXI4-Stream master module, which opens the stimuli txt file and initiates AXI4-Stream transactions to provide stimuli data for the core
- axi4s\_video\_slv  
The AXI4-Stream slave module, which opens the result txt file and verifies AXI4-Stream transactions from the core
- ce\_gen  
Programmable Clock Enable (`ACLKEN`) generator

---

## Running the Simulation

- Simulation using ModelSim for Linux:  
From the console, Type "source run\_mti.sh".
- Simulation using iSim for Linux:  
From the console, Type "source run\_isim.sh".
- Simulation using ModelSim for Windows:  
Double-click on "run\_mti.bat" file.
- Simulation using iSim:  
Double-click on "run\_isim.bat" file.

---

## Directory and File Contents

The directory structure underneath the top-level folder is:

- **expected:**  
Contains the pre-generated expected/golden data used by the testbench to compare actual output data.
- **stimuli:**  
Contains the pre-generated input data used by the testbench to stimulate the core (including register programming values).
- **Results:**  
Actual output data will be written to a file in this folder.
- **Src:**  
Contains the .vhd simulation files and the .xco CORE Generator parameterization file of the core instance. The .vhd file is a netlist generated using CORE Generator. The .xco file can be used to regenerate a new netlist using CORE Generator.

The available core C-model can be used to generate stimuli and expected results for any user bmp image. For more information, refer to [Appendix E, C-Model Reference](#).

The top-level directory contains packages and Verilog modules used by the test bench, as well as:

- **isim\_wave.wcfg:**  
Waveform configuration for ISIM
- **mti\_wave.do:**  
Waveform configuration for ModelSim

- run\_isim.bat :  
Runscript for iSim in Windows
- run\_isim.sh:  
Runscript for iSim in Linux
- run\_mti.bat:  
Runscript for ModelSim in Windows
- run\_mti.sh:  
Runscript for ModelSim in Linux

# Verification, Compliance, and Interoperability

---

## Simulation

A highly parameterizable test bench was used to test the Defective Pixel Correction core. Testing included the following:

- Register accesses
- Processing multiple frames of data
- AXI4-Stream bidirectional data-throttling tests
- Testing detection, and recovery from various AXI4-Stream framing error scenarios
- Testing different `ACLKEN` and `ARESETn` assertion scenarios
- Testing of various frame sizes
- Varying parameter settings

---

## Hardware Testing

The Defective Pixel Correction core has been validated in hardware at Xilinx to represent a variety of parameterizations, including the following:

- A test design was developed for the core that incorporated a MicroBlaze™ processor, AXI4-Lite interconnect and various other peripherals. The software for the test system included pre-generated input and output data along with live video stream. The MicroBlaze processor was responsible for:
  - Initializing the appropriate input and output buffers
  - Initializing the Color Filter Array Interpolation core
  - Launching the test
  - Comparing the output of the core against the expected results
  - Reporting the Pass/Fail status of the test and any errors that were found



---

## Interoperability

The core slave (input) AXI4-Stream interface can work directly with the Video Input core. The core master (output) interface can work directly with the Color Filter Array Interpolation Xilinx Video core.

# Migrating

From version v4.0 to v5.00.a of the DPC core the following significant changes took place:

- XSVI interfaces were replaced by AXI4-Stream interfaces
- Since AXI4-Stream does not carry video timing data, the timing detector and timing generator modules were trimmed.
- The pCore, General Purpose Processor and Transparent modes became obsolete and were removed
- Native support for EDK have been added - the DPC core appears in the EDK IP Catalog
- Debugging features have been added
- The AXI4-Lite control interface register map is standardized between Xilinx video cores

Because of the complex nature of these changes, replacing a v4.0 version of the core in a customer design is not trivial. An existing EDK pCore, Transparent, or Constant DPC instance can be converted from XSVI to AXI4-Stream, the Video in to AXI4-Stream core or using components from XAPP521 (v1.0), *Bridging Xilinx Streaming Video Interface with the AXI4-Stream Protocol* located at:

[http://www.xilinx.com/support/documentation/application\\_notes/xapp521\\_XSVI\\_AXI4.pdf](http://www.xilinx.com/support/documentation/application_notes/xapp521_XSVI_AXI4.pdf).

A v4.0 pCore instance in EDK can be replaced from v5.00.a directly from the EDK IP Catalog. However, the application software needs to be updated for the changed functionality and addresses of the DPC's registers. Consider replacing a legacy DPC pCore from EDK with a v5.00.a instance without AXI4-Lite interface to save resources.

If the user design explicitly used the timing detector or generator functionality of the DPC core, consider adding the Video Timing Controller core to migrate the functionality.

An ISE design using the General Purpose Processor interface, all of the above steps might be necessary:

- Timing detection, generation using the Video Timing Controller Core
- Replacing XSVI interfaces with conversion modules described in XAPP521 or try using the Video in to AXI4-Stream core
- Updating the DPC core instance to v5.00.a with or without AXI4-Lite interface

The INTC interface and debug functionality are new features for v5.00.a. When migrating an existing design, these functions may be disabled.

# Debugging

It is recommended to prototype the system with the AXI4-Lite interface enabled, so status and error detection, reset, and dynamic size programming can be used during debugging.

The following steps are recommended to bring-up/debug the core in a video/imaging system:

1. Bring up the AXI4-Lite interface
2. Bring up the AXI4-Stream interfaces
  - Balancing throughput

Once the core is working as expected, the user may consider 'hardening' the configuration by replacing the DPC core with an instance where GUI default values are set to the established register values, but the AXI4-Lite interface is disabled. This configuration reduces the core slice footprint.

## Bringing up the AXI4-Lite Interface

Table C-1 describes how to troubleshoot the AXI4-Lite interface.

Table C-1: Troubleshooting the AXI4-Lite Interface

Symptom	Solution
Readback from the Version Register via the AXI4-Lite interface times out, or a core instance without an AXI4-Lite interface seems non-responsive.	<p>Is the <code>ACLK</code> pin connected?                      In EDK, verify the <code>ACLK</code> pin connection in the <code>system.mpd</code> file.</p> <p>Does the core receive <code>ACLK</code>?                      The <code>ACLK</code> pin is shared by the AXI4-Lite and AXI4-Stream interfaces. The <code>VERSION_REGISTER</code> readout issue may be indicative of the core not receiving video clock, suggesting an upstream problem in the AXI4-Stream interface.</p>
Readback from the Version Register via the AXI4-Lite interface times out, or a core instance without an AXI4-Lite interface seems non-responsive.	<p>Is the core enabled? Is <code>ACLKEN</code> connected to <code>vcc</code>?                      In EDK, verify that signal <code>ACLKEN</code> is connected in <code>system.mpd</code> to either <code>net_vcc</code> or to a designated clock enable signal.</p>

**Table C-1: Troubleshooting the AXI4-Lite Interface (Cont'd)**

Symptom	Solution
Readback from the Version Register via the AXI4-Lite interface times out, or a core instance without an AXI4-Lite interface seems non-responsive.	Is the core in reset? ARESETn should be connected to vcc for the core not to be in reset. In EDK, verify that signal ARESETn is connected in <b>system.mpd</b> as to either net_vcc or to a designated reset signal.
Readback value for the VERSION_REGISTER is different from expected default values	The core and/or the driver in a legacy EDK/SDK project has not been updated. Ensure that old core versions, implementation files, and implementation caches have been cleared.

Assuming the AXI4-Lite interface works, the second step is to bring up the AXI4-Stream interfaces.

## Bringing up the AXI4-Stream Interfaces

Table C-2 describes how to troubleshoot the AXI4-Stream interface.

**Table C-2: Troubleshooting AXI4-Stream Interface**

Symptom	Solution
Bit 0 of the ERROR register reads back set.	Bit 0 of the ERROR register, EOL_EARLY, indicates the number of pixels received between the latest and the preceding End-Of-Line (EOL) signal was less than the value programmed into the ACTIVE_SIZE register. If the value was provided by the Video Timing Controller core, read out ACTIVE_SIZE register value from the VTC core again, and make sure that the TIMING_LOCKED flag is set in the VTC core. Otherwise, using Chipscope, measure the number of active AXI4-Stream transactions between EOL pulses.
Bit 1 of the ERROR register reads back set.	Bit 1 of the ERROR register, EOL_LATE, indicates the number of pixels received between the last End-Of-Line (EOL) signal surpassed the value programmed into the ACTIVE_SIZE register. If the value was provided by the Video Timing Controller core, read out ACTIVE_SIZE register value from the VTC core again, and make sure that the TIMING_LOCKED flag is set in the VTC core. Otherwise, using Chipscope, measure the number of active AXI4-Stream transactions between EOL pulses.
Bit 2 or Bit 3 of the ERROR register reads back set.	Bit 2 of the ERROR register, SOF_EARLY, and bit 3 of the ERROR register SOF_LATE indicate the number of pixels received between the latest and the preceding Start-Of-Frame (SOF) differ from the value programmed into the ACTIVE_SIZE register. If the value was provided by the Video Timing Controller core, read out ACTIVE_SIZE register value from the VTC core again, and make sure that the TIMING_LOCKED flag is set in the VTC core. Otherwise, using Chipscope, measure the number EOL pulses between subsequent SOF pulses.
s_axis_video_tready stuck low, the upstream core cannot send data.	During initialization, the DPC core keeps its s_axis_video_tready input low. Afterwards, the core should assert s_axis_video_tready automatically. Is m_axis_video_tready low? If so, the DPC core cannot send data downstream, and the internal FIFOs are full.

Table C-2: Troubleshooting AXI4-Stream Interface

Symptom	Solution
m_axis_video_tvalid stuck low, the downstream core is not receiving data	If the programmed active number of pixels per line is radically smaller than the actual line length, the core drops most of the pixels waiting for the (s_axis_video_tlast) End-of-line signal. Check the ERROR register.
Generated SOF signal (m_axis_video_tuser0) signal misplaced.	Check the ERROR register.
Generated EOL signal (m_axis_video_tlast) signal misplaced.	Check the ERROR register.
Data samples lost between Upstream core and the DPC core. Inconsistent EOL and/or SOF periods received.	<ol style="list-style-type: none"> <li>1. Are the Master and Slave AXI4-Stream interfaces in the same clock domain?</li> <li>2. Is proper clock-domain crossing logic instantiated between the upstream core and the DPC core (Asynchronous FIFO)?</li> <li>3. Did the design meet timing?</li> <li>4. Is the frequency of the clock source driving the DPC ACLK pin lower than the reported Fmax reached?</li> </ol>
Data samples lost between Downstream core and the DPC core. Inconsistent EOL and/or SOF periods received.	<ol style="list-style-type: none"> <li>1. Are the Master and Slave AXI4-Stream interfaces in the same clock domain?</li> <li>2. Is proper clock-domain crossing logic instantiated between the upstream core and the DPC core (Asynchronous FIFO)?</li> <li>3. Did the design meet timing?</li> <li>4. Is the frequency of the clock source driving the DPC ACLK pin lower than the reported Fmax reached?</li> </ol>

## Debugging Features

The DPC core is equipped with optional debugging features which aim to accelerate system bring-up, optimize memory and data-path architecture and reduce time to market. The optional debug features can be turned on/off via the **Include Debug Features** checkbox on the GUI when an AXI4-Lite interface is present. Turning off debug features reduces the core Slice footprint.

### Core Bypass Option

The bypass option facilitates establishing a straight through connection between input (AXI4-Stream slave) and output (AXI4-Stream master) interfaces bypassing any processing functionality.

Flag `BYPASS` (bit 4 of the `CONTROL` register) can turn bypass on (1) or off, when the core instance Debugging Features were enabled at generation. Within the IP this switch controls multiplexers in the AXI4-Stream path.

In bypass mode the DPC core processing function is bypassed, and the core repeats AXI4-Stream input samples on its output.

Starting a system with all processing cores set to bypass, then by turning bypass off from the system input towards the system output allows verification of subsequent cores with known good stimuli.

## Built in Test-Pattern Generator

The optional built-in test-pattern generator facilitates to temporarily feed the output AXI4-Stream master interface with a predefined pattern.

Flag `TEST_PATTERN` (bit 5 of the `CONTROL` register) can turn test-pattern generation on (1) or off, when the core instance Debugging Features were enabled at generation. Within the IP this switch controls multiplexers in the AXI4-Stream path, switching between the regular core processing output and the test-pattern generator. When enabled, a set of counters generate 256 scan-lines of color-bars, each color bar 64 pixels wide, repetitively cycling through Black, Red, Green, Yellow, Blue, Magenta, Cyan, and White colors till the end of each scan-line. After the Color-Bars segment, the rest of the frame is filled with a monochrome horizontal and vertical ramp.

Starting a system with all processing cores set to test-pattern mode, then by turning test-pattern generation off from the system output towards the system input allows successive bring-up and parameterization of subsequent cores.

## Throughput Monitors

Throughput monitors enable the user to monitor processing performance within the core. This information can be used to help debug frame-buffer bandwidth limitation issues, and if possible, allow video application software to balance memory pathways.

Often times video systems, with multiport access to a shared external memory, have different processing islands. For example a pre-processing sub-system working in the input video clock domain may clean up, transform, and write a video stream, or multiple video streams, to memory. The processing sub-system may read the frames out, process, scale, encode, then write frames back to the frame buffer, in a separate processing clock domain. Finally, the output sub-system may format the data and read out frames locked to an external clock.

Typically, access to external memory using a multiport memory controller involves arbitration between competing streams. However, to maximize the throughput of the system, different memory ports may need different specific priorities. To fine tune the

arbitration and dynamically balance frame rates, it is beneficial to have access to throughput information measured in different video data paths.

The SYSDEBUG0 (0x0014), or Frame Throughput Monitor, register indicates the number of frames processed since power-up or the last time the core was reset. The SYSDEBUG1 (0x0018), or Line Throughput Monitor, register indicates the number of lines processed since power-up or the last time the core was reset. The SYSDEBUG2 (0x001C), or Pixel Throughput Monitor, register indicates the number of pixels processed since power-up or the last time the core was reset.

Priorities of memory access points can be modified by the application software dynamically to equalize frame, or partial frame rates.

## Interfacing to Third-Party IP

Table C-3 describes how to troubleshoot third-party interfaces.

Table C-3: Troubleshooting Third-Party Interfaces

Symptom	Solution
Severe color distortion or color-swap when interfacing to third-party video IP.	Verify that the color component logical addressing on the AXI4-Stream TDATA signal is in according to <a href="#">Data Interface in Chapter 2</a> . If misaligned: In HDL, break up the TDATA vector to constituent components and manually connect the slave and master interface sides. In EDK, create a new vector for the slave side TDATA connection. In the MPD file, manually assign components of the master-side TDATA vector to sections of the new vector.
Severe color distortion or color-swap when processing video written to external memory using the AXI-VDMA core.	Unless the particular software driver was developed with the AXI4-Stream TDATA signal color component assignments described in <a href="#">Data Interface in Chapter 2</a> in mind, there are no guarantees that the software will correctly identify bits corresponding to color components. Verify that the color component logical addressing TDATA is in alignment with the data format expected by the software drivers reading/writing external memory. If misaligned: In HDL, break up the TDATA vector to constituent components, and manually connect the slave and master interface sides. In EDK, create a new vector for the slave side TDATA connection. In the MPD file, manually assign components of the master-side TDATA vector to sections of the new vector.



# Application Software Development

## Programmer's Guide

The software API is provided to allow easy access to the DPC AXI4-Lite registers defined in [Table 2-7](#). To utilize the API functions, the following two header files must be included in the user C code:

```
#include "dpc.h"
#include "xparameters.h"
```

The hardware settings of your system, including the base address of your DPC core, are defined in the `xparameters.h` file. The `dpc.h` file contains the macro function definitions for controlling the DPC pCore.

For examples on API function calls and integration into a user application, the drivers subdirectory of the pCore contains a file, `example.c`, in the `dpc_v5_00_a0_a/example` subfolder. This file is a sample C program that demonstrates how to use the DPC pCore API.

*Table D-1: DPC Driver Function Definitions*

Function Name and Parameterization	Description
DPC_Enable (uint32 BaseAddress)	Enables a DPC instance.
DPC_Disable (uint32 BaseAddress)	Disables a DPC instance.
DPC_Reset (uint32 BaseAddress)	Immediately resets a DPC instance. The core stays in reset until the RESET flag is cleared.
DPC_ClearReset (uint32 BaseAddress)	Clears the reset flag of the core, which allows it to re-sync with the input video stream and return to normal operation.
DPC_FSync_Reset (uint32 BaseAddress)	Resets a DPC instance on the next SOF signal.
DPC_ReadReg (uint32 BaseAddress, uint32 RegOffset)	Returns the 32-bit unsigned integer value of the register. Read the register selected by RegOffset (defined in <a href="#">Table 2-10</a> ).
DPC_WriteReg (uint32 BaseAddress, uint32 RegOffset, uint32 Data)	Write the register selected by RegOffset (defined in <a href="#">Table 2-10</a> ). Data is the 32-bit value to write to the register.

Table D-1: DPC Driver Function Definitions

Function Name and Parameterization	Description
DPC_RegUpdateEnable (uint32 BaseAddress)	Enables copying double buffered registers at the beginning of the next frame. Refer to <a href="#">Double Buffering</a> for more information.
DPC_RegUpdateDisable (uint32 BaseAddress)	Disables copying double buffered registers at the beginning of the next frame. Refer to <a href="#">Double Buffering</a> for more information.

## Software Reset

Software reset reinitializes registers of the AXI4-Lite control interface to their initial value, resets FIFOs, forces `m_axis_video_tvalid` and `s_axis_video_tready` to 0.

`DPC_Reset()` and `DPC_AutoSyncReset()` reset the core immediately if the core is not currently processing a frame. If the core is currently processing a frame calling `DPC_Reset()`, or setting bit 30 of the `CONTROL` register to 1 will cause image tearing. After calling `DPC_Reset()`, the core remains in reset until `DPC_ClearReset()` is called.

Calling `DPC_AutoSyncReset()` automates this reset process by waiting until the core finishes processing the current frame, then asserting the reset signal internally, keeping the core in reset only for 32 `ACLK` cycles, then deasserting the signal automatically. After calling `DPC_AutoSyncReset()`, it is not necessary to call `DPC_ClearReset()` for the core to return to normal operating mode.

**Note:** Calling `DPC_FSync_Reset()` does not guarantee prompt, or real-time resetting of the core. If the AXI4-Stream communication is halted mid frame, the core will not reset until the upstream core finishes sending the current frame or starts a new frame.

## Double Buffering

The `ACTIVE_SIZE` register and all of the core specific registers double-buffered to ensure no image tearing happens if values are modified during frame processing. Values from the AXI4-Lite interface are latched into processor registers immediately after writing, and processor register values are copied into the active register set at the Start Of Frame (SOF) signal. Double-buffering decouples AXI4-Lite register updates from the AXI4-Stream processing, allowing software a large window of opportunity to update processing parameter values without image tearing.

If multiple register values are changed during frame processing, simple double buffering would not guarantee that all register updates would take effect at the beginning of the same frame. Using a semaphore mechanism, the `RegUpdateEnable()` and `RegUpdateDisable()` functions allows synchronous commitment of register changes. The DPC core will start using the updated `ACTIVE_SIZE` and core-specific values only if the `REGUPDATE` flag of the `CONTROL` register is set (1), after the next Start-Of-Frame signal (`s_axis_video_tuser0`) is received. Therefore, it is recommended to disable the register update before writing multiple double-buffered registers, then enable register update when register writes are completed.

## Reading and Writing Registers

Each software register that is defined in [Table 2-10](#) has a constant that is defined in `spc.h` which is set to the offset for that register listed in [Table D-2](#). It is recommended that the application software uses the predefined register names instead of register values when accessing core registers, so future updates to the DPC drivers which may change register locations will not affect the application dependent on the DPC driver.

*Table D-2: Predefined Constants Defined in spc.h*

Constant Name Definition	Value	Target Register
DPC_CONTROL	0x0000	CONTROL
DPC_STATUS	0x0004	STATUS
DPC_ERROR	0x0008	ERROR
DPC_IRQ_ENABLE	0x000C	IRQ_ENABLE
DPC_VERSION	0x0010	VERSION
DPC_SYSDEBUG0	0x0014	SYSDEBUG0
DPC_SYSDEBUG1	0x0018	SYSDEBUG1
DPC_SYSDEBUG2	0x001C	SYSDEBUG2
DPC_ACTIVE_SIZE	0x0020	ACTIVE_SIZE
DPC_THRESH_TEMPORAL_VAR	0x0100	THRESH_TEMPORAL_VAR
DPC_THRESH_SPATIAL_VAR	0x0104	THRESH_SPATIAL_VAR
DPC_THRESH_PIXEL_AGE	0x0108	THRESH_PIXEL_AGE
DPC_NUM_CANDIDATES	0x010C	NUM_CANDIDATES
DPC_NUM_DEFECTIVE	0x0120	NUM_DEFECTIVE

# C-Model Reference

## Installation and Directory Structure

This chapter contains information for installing the Defective Pixel Correction C-Model, and describes the file contents and directory structure.

### Software Requirements

The Defective Pixel Correction v5.00.a C-models were compiled and tested with the following software versions.

*Table E-1: Supported Systems and Software Requirements*

Platform	C-Compiler
Linux 32-bit and 64-bit	GCC 4.1.1
Windows 32-bit and 64-bit	Microsoft Visual Studio 2005, Visual Studio 2008 (Visual C++ 8.0)

### Installation

The installation of the C-Model requires updates to the PATH variable, as described below.

#### Linux

Ensure that the directory in which the `libIp_v_spc_v4_00_a_bitacc_cmodel.so` and `libstlport.so.5.1` files are located is in your `$LD_LIBRARY_PATH` environment variable.

## C-Model File Contents

Unzipping the `v_spc_v4_00_a_bitacc_model.zip` file creates the following directory structures and files which are described in [Table E-2](#).

**Table E-2: C-Model Files**

File	Description
/lin	Pre-compiled bit accurate ANSI C reference model for simulation on 32-bit Linux Platforms
libIp_v_spc_v4_00_a_bitacc_cmodel.lib	Defective Pixel Correction v5.00.a model shared object library (Linux platforms only)
libstlport.so.5.1	STL library, referenced by the Defective Pixel Correction and RGB to YCrCb object libraries (Linux platforms only)
run_bitacc_cmodel	Pre-compiled bit accurate executable for simulation on 32-bit Linux Platforms
/lin64	Pre-compiled bit accurate ANSI C reference model for simulation on 64-bit Linux Platforms
libIp_v_spc_v4_00_a_bitacc_cmodel.lib	Defective Pixel Correction v5.00.a model shared object library (Linux platforms only)
libstlport.so.5.1	STL library, referenced by the Defective Pixel Correction and RGB to YCrCb object libraries (Linux platforms only)
run_bitacc_cmodel	Pre-compiled bit accurate executable for simulation on 32-bit Linux Platforms
/nt	Pre-compiled bit accurate ANSI C reference model for simulation on 32-bit Windows Platforms
libIp_v_spc_v4_00_a_bitacc_cmodel.lib	Pre-compiled library file for win32 compilation
run_bitacc_cmodel.exe	Pre-compiled bit accurate executable for simulation on 32-bit Windows Platforms
/nt64	Pre-compiled bit accurate ANSI C reference model for simulation on 64-bit Windows Platforms
libIp_v_spc_v4_00_a_bitacc_cmodel.lib	Pre-compiled library file for win32 compilation
run_bitacc_cmodel.exe	Pre-compiled bit accurate executable for simulation on 64-bit Windows Platforms
README.txt	Release notes
pg002_v_spc.pdf	<i>Defective Pixel Correction Interpolation Core Product Guide</i>
v_spc_v4_00_a_bitacc_cmodel.h	Model header file
rgb_utils.h	Header file declaring the RGB image / video container type and support functions
bmp_utils.h	Header file declaring the bitmap (.bmp) image file I/O functions
video_utils.h	Header file declaring the generalized image / video container type, I/O and support functions.

Table E-2: C-Model Files (Cont'd)

File	Description
Kodim19_128x192.bmp	128x192 sample test image of the Lighthouse image from the True-color Kodak test images
run_bittacc_cmodel.c	Example code calling the C-Model

## Using the C-Model

The bit accurate C model is accessed through a set of functions and data structures that are declared in the `v_spc_v4_00_a_bittacc_cmodel.h` file.

Before using the model, the structures holding the inputs, generics and output of the DPC instance must be defined:

```

struct xilinx_ip_v_spc_v4_00_a_generics spc_generics;
struct xilinx_ip_v_spc_v4_00_a_inputs spc_inputs;
struct xilinx_ip_v_spc_v4_00_a_outputs spc_outputs;
    
```

The declaration of these structures is in the `v_spc_v4_00_a_bittacc_cmodel.h` file.

Table E-3 lists the generic parameters taken by the DPC v5.00.a IP core bit accurate model, as well as the default values. For an actual instance of the core, these parameters can only be set in generation time through the CORE Generator™ GUI.

Table E-3: Model Generic Parameters and Default Values

Generic Variable	Type	Default Value	Range	Description
IWIDTH	int	8	8,10,12, 16	Input data width
OWIDTH	int	8	8,10,12, 16	Output width
INPUT_VIDEO_FORMAT	int	2	1, 2	Input Video Format 1=YUV 4:4:4 2=RGB
OUTPUT_VIDEO_FORMAT	int	2	1 2	Output Video Format 1=YUV 4:4:4 2=RGB

Calling `xilinx_ip_v_spc_v4_00_a_get_default_generics(&spc_generics)` initializes the generics structure with the DPC GUI defaults, listed in Table E-3.

Coefficients, offsets, clipping and clamping values can also be set dynamically through the pCore and General Purpose Processor interfaces. Consequently, these values are passed as inputs to the core, along with the actual test image, or video sequence (Table E-4).

Table E-4: Core Generic Parameters and Default Values

Input Variable	Type	Default Value	Range <sup>(1)</sup>	Description
video_in	video_struct	null	N/A	Container to hold input image or video data. <sup>2</sup>
coeffs	double[3][3]	identity <sup>1</sup>	[-4 to 4]	3x3 matrix of floating point numbers
offsets	double[3]	zeros <sup>1</sup>	$-2^{OWIDTH}$ to $2^{OWIDTH} - 1$	Offsets applied to the output color channels
CLAMP	int	0	0 to $2^{OWIDTH} - 1$	Clamping value for outputs
CLIP	int	$2^{OWIDTH} - 1$	0 to $2^{OWIDTH} - 1$	Clipping value for outputs

1. OWIDTH is the output data width of each color component

<sup>1</sup> For a detailed description of inputs and other generic parameters, see [Core Interfaces and Register Space](#).

<sup>2</sup> For the description of the input structure, see [Initializing the DPC Input Video Structure](#).

The structure `spc_inputs` defines the values of run time parameters and the actual input image. Calling

```
xilinx_ip_v_spc_v4_00_a_get_default_inputs(&spc_generics,
&spc_inputs) initializes the input structure with the DPC GUI default values (see Table E-4).
```

**Note:** The `video_in` variable is not initialized because the initialization depends on the actual test image to be simulated. [Initializing the DPC Input Video Structure](#) describes the initialization of the `video_in` structure.

After the inputs are defined, the model can be simulated by calling this function:

```
int xilinx_ip_v_spc_v4_00_a_bitacc_simulate(
struct xilinx_ip_v_spc_v4_00_a_generics* generics,
struct xilinx_ip_v_spc_v4_00_a_inputs* inputs,
struct xilinx_ip_v_spc_v4_00_a_outputs* outputs).
```

Results are included in the `outputs` structure, which contains only one member, type `video_struct`. After the outputs are evaluated and saved, dynamically allocated memory for input and output video structures must be released by calling this function:

```
void xilinx_ip_v_spc_v4_00_a_destroy(
struct xilinx_ip_v_spc_v4_00_a_inputs *input,
struct xilinx_ip_v_spc_v4_00_a_outputs *output).
```

Successful execution of all provided functions, except for the destroy function, return value 0. A non-zero error code indicates that problems occurred during function calls.

## DPC Input and Output Video Structure

Input images or video streams can be provided to the DPC v5.00.a reference model using the `video_struct` structure, defined in `video_utils.h`:

```

struct video_struct{
    int      frames, rows, cols, bits_per_component, mode;
    uint16*** data[5]; };
    
```

**Table E-5: Member Variables of the Video Structure**

Member Variable	Designation
frames	Number of video/image frames in the data structure.
rows	Number of rows per frame. Pertaining to the image plane with the most rows and columns, such as the luminance channel for YUV data. Frame dimensions are assumed constant through all frames of the video stream. However different planes, such as y, u and v can have different dimensions.
cols	Number of columns per frame. Pertaining to the image plane with the most rows and columns, such as the luminance channel for YUV data. Frame dimensions are assumed constant through all frames of the video stream. However different planes, such as y, u and v can have different dimensions.
bits_per_component	Number of bits per color channel/component. All image planes are assumed to have the same color/component representation. Maximum number of bits per component is 16.
mode	Contains information about the designation of data planes. Named constants to be assigned to mode are listed in <a href="#">Table E-6</a> .
data	Set of five pointers to three dimensional arrays containing data for image planes. Data is in 16-bit unsigned integer format accessed as <code>data[plane][frame][row][col]</code> .

**Table E-6: Named Video Modes with Corresponding Planes and Representations**

Mode <sup>(1)</sup>	Planes	Video Representation
FORMAT_MONO	1	Monochrome – Luminance only
FORMAT_RGB	3	RGB image/video data
FORMAT_C444	3	444 YUV, or YCrCb image/video data
FORMAT_C422	3	422 format YUV video, (u, v chrominance channels horizontally sub-sampled)



Table E-6: Named Video Modes with Corresponding Planes and Representations

FORMAT_C420	3	420 format YUV video, ( u, v sub-sampled both horizontally and vertically )
FORMAT_MONO_M	3	Monochrome (Luminance) video with Motion
FORMAT_RGBA	4	RGB image/video data with alpha (transparency) channel
FORMAT_C420_M	5	420 YUV video with Motion
FORMAT_C422_M	5	422 YUV video with Motion
FORMAT_C444_M	5	444 YUV video with Motion
FORMAT_RGBM	5	RGB video with Motion

1. The Defective Pixel Correction core supports Modes FORMAT\_RGB and FORMAT\_C444.

## Initializing the DPC Input Video Structure

The easiest way to assign stimuli values to the input video structure is to initialize it with an image or video. The `bmp_util.h` and `video_util.h` header files packaged with the bit accurate C models contain functions to facilitate file I/O.

### Bitmap Image Files

The header `bmp_utils.h` declares functions that help access files in Windows Bitmap format ([http://en.wikipedia.org/wiki/BMP\\_file\\_format](http://en.wikipedia.org/wiki/BMP_file_format)). However, this format limits color depth to a maximum of 8-bits per pixel, and operates on images with three planes (R,G,B). Consequently, the following functions operate on arguments type `rgb8_video_struct`, which is defined in `rgb_utils.h`. Also, both functions support only true-color, non-indexed formats with 24-bits per pixel.

```
int write_bmp(FILE *outfile, struct rgb8_video_struct *rgb8_video);
int read_bmp(FILE *infile, struct rgb8_video_struct *rgb8_video);
```

Exchanging data between `rgb8_video_struct` and general `video_struct` type frames/videos is facilitated by these functions:

```
int copy_rgb8_to_video(struct rgb8_video_struct* rgb8_in,
                     struct video_struct* video_out );
int copy_video_to_rgb8(struct video_struct* video_in,
                     struct rgb8_video_struct* rgb8_out );
```

**Note:** All image/video manipulation utility functions expect both input and output structures initialized; for example, pointing to a structure that has been allocated in memory, either as static or dynamic variables. Moreover, the input structure must have the dynamically allocated container (data or r, g, b) structures already allocated and initialized with the input frame(s). If the output container structure is pre-allocated at the time of the function call, the utility functions verify and issue an error if the output container size does not match the size of the expected output. If the output container structure is not pre-allocated, the utility functions create the appropriate container to hold results.

## Binary Image/Video Files

The `video_utils.h` header file declares functions that help load and save generalized video files in raw, uncompressed format.

```
int read_video( FILE* infile,  struct video_struct* in_video);
int write_video(FILE* outfile, struct video_struct* out_video);
```

These functions serialize the `video_struct` structure. The corresponding file contains a small, plain text header defining, "Mode", "Frames", "Rows", "Columns", and "Bits per Pixel". The plain text header is followed by binary data, 16-bits per component in scan line continuous format. Subsequent frames contain as many component planes as defined by the video mode value selected. Also, the size (rows, columns) of component planes can differ within each frame as defined by the actual video mode selected.

## Working with Video\_struct Containers

The `video_utils.h` header file defines functions to simplify access to video data in `video_struct`.

```
int video_planes_per_mode(int mode);
int video_rows_per_plane(struct video_struct* video, int plane);
int video_cols_per_plane(struct video_struct* video, int plane);
```

The `video_planes_per_mode` function returns the number of component planes defined by the mode variable, as described in [Table E-6](#). The `video_rows_per_plane` and `video_cols_per_plane` functions return the number of rows and columns in a given plane of the selected video structure. The following example demonstrates using these functions in conjunction to process all pixels within a video stream stored in the `in_video` variable:

```
for (int frame = 0; frame < in_video->frames; frame++) {
  for (int plane = 0; plane < video_planes_per_mode(in_video->mode); plane++) {
    for (int row = 0; row < rows_per_plane(in_video,plane); row++) {
      for (int col = 0; col < cols_per_plane(in_video,plane); col++) {
        // User defined pixel operations on
        // in_video->data[plane][frame][row][col]
      }
    }
  }
}
```

## C Model Example Code

An example C file, `run_bitacc_cmodel.c`, is provided to demonstrate the steps required to run the model. After following the compilation instructions, run the example executable. The executable takes the path/name of the input file and the path/name of the output file as parameters. If invoked with insufficient parameters, this help message is issued:

```
Usage: run_bitacc_cmodel in_file out_file
```

```
in_file      : path/name of the input  BMP file
out_file     : path/name of the output BMP file
```

During successful execution, two files with a .bin extension are created. The first file corresponds to the input BMP image, with the same path and name as the input file, and a .bin extension. The other file similarly corresponds to the output file. These files contain the inputs and outputs of the DPC algorithm in full precision, as the BMP format does not support color resolutions beyond 8-bits per component. The structure of .bin files are described in [Binary Image/Video Files](#).

# Compiling with the DPC C-Model

## Linux (32- and 64-bit)

To compile the example code, first ensure that the directory in which the files `libIp_v_spc_v4_00_a_bitacc_cmodel.so` and `libstlport.so.5.1` are located is present in your `$LD_LIBRARY_PATH` environment variable. These shared libraries are referenced during the compilation and linking process. Then `cd` into the directory where the header files, library files and `run_bitacc_cmodel.c` were unpacked. The libraries and header files are referenced during the compilation and linking process.

Place the header file and C source file in a single directory. Then in that directory, compile using the GNU C Compiler:

```
gcc -m32 -x c++ ../run_bitacc_cmodel.c ../parsers.c -o run_bitacc_cmodel -L.  
-lIp_v_spc_v4_00_a_bitacc_cmodel -Wl,-rpath,.  
  
gcc -m64 -x c++ ../run_bitacc_cmodel.c ../parsers.c -o run_bitacc_cmodel -L.  
-lIp_v_spc_v4_00_a_bitacc_cmodel -Wl,-rpath,.
```

## Windows (32- and 64-bit)

Precompiled library `v_spc_v4_00_a_bitacc_cmodel.dll`, and top level demonstration code `run_bitacc_cmodel.c` should be compiled with an ANSI C compliant compiler under Windows. Here an example is presented using Microsoft Visual Studio.

In Visual Studio create a new, empty Windows Console Application project. As existing items, add:

- The `llibIpv_spc_v4_00_a_bitacc_cmodel.dll` file to the "Resource Files" folder of the project
- The `run_bitacc_cmodel.c` file to the "Source Files" folder of the project
- The `v_spc_v4_00_a_bitacc_cmodel.h` header files to "Header Files" folder of the project (optional)

After the project has been created and populated, it needs to be compiled and linked (built) to create a win32 executable. To perform the build step, choose **Build Solution** from the Build menu. An executable matching the project name has been created either in the Debug or Release subdirectories under the project location based on whether **Debug** or **Release** has been selected in the **Configuration Manager** under the Build menu.

# Additional Resources

---

## Xilinx Resources

For support resources such as Answers, Documentation, Downloads, and Forums, see the Xilinx Support website at:

<http://www.xilinx.com/support>.

For a glossary of technical terms used in Xilinx documentation, see:

[http://www.xilinx.com/support/documentation/sw\\_manuals/glossary.pdf](http://www.xilinx.com/support/documentation/sw_manuals/glossary.pdf).

For a comprehensive listing of Video and Imaging application notes, white papers, reference designs and related IP cores, see the Video and Imaging Resources page at:

[http://www.xilinx.com/esp/video/refdes\\_listing.htm#ref\\_des](http://www.xilinx.com/esp/video/refdes_listing.htm#ref_des).

---

## Solution Centers

See the [Xilinx Solution Centers](#) for support on devices, software tools, and intellectual property at all stages of the design cycle. Topics include design assistance, advisories, and troubleshooting tips.

---

## References

These documents provide supplemental material useful with this user guide:

1. [UG761 AXI Reference Guide](#).

---

## Technical Support

Xilinx provides technical support at [www.xilinx.com/support](http://www.xilinx.com/support) for this LogiCORE™ IP product when used as described in the product documentation. Xilinx cannot guarantee timing, functionality, or support of product if implemented in devices that are not defined in the documentation, if customized beyond that allowed in the product documentation, or if changes are made to any section of the design labeled DO NOT MODIFY.

See the IP Release Notes Guide ([XTP025](#)) for more information on this core. For each core, there is a master Answer Record that contains the Release Notes and Known Issues list for the core being used. The following information is listed for each version of the core:

- New Features
- Resolved Issues
- Known Issues

---

## Ordering Information

The Defective Pixel Correction v5.00.a core is provided under the [Xilinx Core License Agreement](#) and can be generated using the Xilinx® CORE Generator™ system and EDK software. The CORE Generator system is shipped with Xilinx ISE® Design Suite software. The CORE Generator system and EDK are shipped with the Xilinx ISE Embedded Edition Design software.

Contact your local Xilinx [sales representative](#) for pricing and availability of additional Xilinx LogiCORE IP modules and software. Information about additional Xilinx LogiCORE IP modules is available on the Xilinx [IP Center](#).

---

## Revision History

The following table shows the revision history for this document.

Date	Version	Revision
10/19/2011	1.0	Initial Xilinx release of Product Guide, replacing DS721 and UG838.
4/24/2012	2.0	Updated for core version. Added Zynq-7000 devices, added AXI4-Stream interfaces, deprecated GPP interface.

---

## Notice of Disclaimer

The information disclosed to you hereunder (the "Materials") is provided solely for the selection and use of Xilinx products. To the maximum extent permitted by applicable law: (1) Materials are made available "AS IS" and with all faults, Xilinx hereby DISCLAIMS ALL WARRANTIES AND CONDITIONS, EXPRESS, IMPLIED, OR STATUTORY, INCLUDING BUT NOT LIMITED TO WARRANTIES OF MERCHANTABILITY, NON-INFRINGEMENT, OR FITNESS FOR ANY PARTICULAR PURPOSE; and (2) Xilinx shall not be liable (whether in contract or tort, including negligence, or under any other theory of liability) for any loss or damage of any kind or nature related to, arising under, or in connection with, the Materials (including your use of the Materials), including for any direct, indirect, special, incidental, or consequential loss or damage (including loss of data, profits, goodwill, or any type of loss or damage suffered as a result of any action brought by a third party) even if such damage or loss was reasonably foreseeable or Xilinx had been advised of the possibility of the same. Xilinx assumes no obligation to correct any errors contained in the Materials or to notify you of updates to the Materials or to product specifications. You may not reproduce, modify, distribute, or publicly display the Materials without prior written consent. Certain products are subject to the terms and conditions of the Limited Warranties which can be viewed at <http://www.xilinx.com/warranty.htm>; IP cores may be subject to warranty and support terms contained in a license issued to you by Xilinx. Xilinx products are not designed or intended to be fail-safe or for use in any application requiring fail-safe performance; you assume sole risk and liability for use of Xilinx products in Critical Applications: <http://www.xilinx.com/warranty.htm#critapps>.

© Copyright 2011–2012 Xilinx, Inc. Xilinx, the Xilinx logo, Artix, ISE, Kintex, Spartan, Virtex, Zynq, and other designated brands included herein are trademarks of Xilinx in the United States and other countries. All other trademarks are the property of their respective owners.