

Video Timing Controller v6.1

LogiCORE IP Product Guide

PG016 May 22, 2019



Table of Contents

IP Facts

Chapter 1: Overview

Feature Summary	7
Applications	7
Licensing and Ordering	8

Chapter 2: Product Specification

Standards	9
Performance	9
Resource Utilization	10
Core Interfaces and Register Space	10

Chapter 3: Designing with the Core

Basic Architecture	39
Control Signals and Timing	40
Use Model	53
Clocking	56
Resets	57
Protocol Description	58

Chapter 4: Customizing and Generating the Core

Vivado Integrated Design Environment (IDE)	59
Graphical User Interface	60
Output Generation	71

Chapter 5: Constraining the Core

Required Constraints	73
----------------------------	----

Chapter 6: Simulation

Chapter 7: Synthesis and Implementation

Chapter 8: Detailed Example Design

Chapter 9: Test Bench

Demonstration Test Bench	77
--------------------------------	----

Appendix A: Verification, Compliance, and Interoperability

Simulation	79
Hardware Testing	79

Appendix B: Upgrading

Migrating to the Vivado Design Suite	81
Upgrading in Vivado Design Suite	81

Appendix C: Debugging

Finding Help on Xilinx.com	83
Debug Tools	84
Hardware Debug	85
Interface Debug	86

Appendix D: Additional Resources

Xilinx Resources	88
Documentation Navigator and Design Hubs	88
References	89
Revision History	89
Please Read: Important Legal Notices	90

Introduction

The Xilinx® LogiCORE™ IP Video Timing Controller core is a general purpose video timing generator and detector. The core is highly programmable through a comprehensive register set allowing control of various timing generation parameters. This programmability is coupled with a comprehensive set of interrupt bits which provides easy integration into a processor system for in-system control of the block in real-time. The Video Timing Controller is provided with an optional AXI4-Lite compliant interface.

Features

- Support for progressive or interlaced video frame sizes up to 8192 x 8192
- Direct regeneration of output timing signals with independent timing and polarity inversion
- Automatic detection and generation of horizontal and vertical video timing signals
- Support for multiple combinations of blanking or synchronization signals
- Automatic detection of input video control signal polarities
- Support for detection and generation of horizontal delay of vertical blank/sync
- Programmable output video signal polarities
- Generation of up to 16 additional independent output frame synchronization signals
- Optional AXI4-Lite processor interface
- High number of interrupts and status registers for easy system control and integration

LogiCORE IP Facts Table	
Core Specifics	
Supported Device Family ⁽¹⁾	UltraScale+™ Families, UltraScale™ Architecture, Zynq® -7000, 7 Series FPGAs
Supported User Interfaces	AXI4-Lite ⁽²⁾
Resources	See Resource Utilization .
Provided with Core	
Documentation	Product Guide
Design Files	Encrypted RTL
Example Design	Not Provided
Test Bench	Verilog
Constraints File	XDC
Simulation Models	Encrypted RTL, VHDL or Verilog Structural
Supported Software Drivers ⁽³⁾	Standalone
Tested Design Flows ⁽⁴⁾	
Design Entry Tools	Vivado® Design Suite
Simulation	For supported simulators, see the Xilinx Design Tools: Release Notes Guide .
Synthesis Tools	Vivado Synthesis
Support	
Provided by Xilinx at the, Inc.	

1. For a complete listing of supported devices, see the Vivado IP Catalog.
2. Refer to the *Video IP: AXI Feature Adoption* section of AXI Reference Guide [Ref 1].
3. Standalone driver details can be found in the SDK directory (<install_directory>/SDK/<release>/data/embeddedsw/doc/xilinx_drivers.htm). Linux OS and driver support information is available from the [Xilinx Wiki page](#).
4. For the supported versions of the tools, see the [Xilinx Design Tools: Release Notes Guide](#).

Overview

All video systems require management of video timing signals, which are used to synchronize processes. The Video Timing Controller serves the function of both detecting and generating these timing signals.

The input side of this core automatically detects horizontal and vertical synchronization pulses, polarity, blanking timing and active video pixels. While on the output, it generates the horizontal and vertical blanking and synchronization pulses used with a standard video system including support for programmable pulse polarity. The core is commonly used with the Video in to AXI4-Stream core to detect the format and timing of incoming video data or with the AXI4-Stream to Video out core to generate outgoing video timing for downstream sinks such as a video monitor.

Figure 1-1 shows a typical video frame including timing signals.



IMPORTANT: *All signals are shown with active-High polarity.*

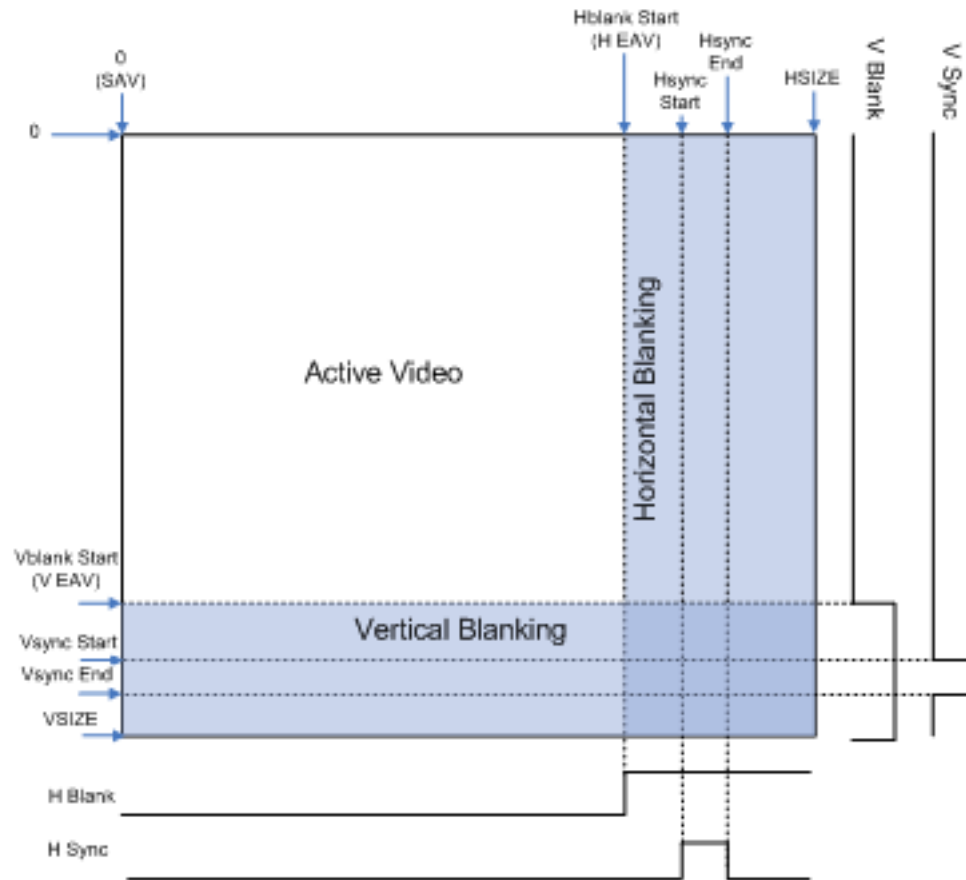

Figure 1-1: Example Video Frame and Timing Signals

A video frame can be completely described in terms of timing by only a few definitions. A video frame comprises active video and blanking periods. The vertical and horizontal synchronization signals describe the video frame timing, which includes active and blanking data. In addition, the frame synchronization signals can be used to synchronize video data from one component to another within a video system. There are additional signals that can also be used to control the video system, such as a signal to differentiate valid chroma samples.

Video systems may utilize different combinations of blank, synchronization or active signals with various polarities to synchronize processing and control video data. The Video Timing Controller simplifies working with video timing signals by providing a highly programmable and flexible core that allows detection and generation of the various timing signals within a video system.

Feature Summary

The Video Timing Controller core supports the AXI4-Lite interface and a constant-mode interface. The AXI4-Lite interface allows the core to be easily incorporated into a Vivado project. The Constant interface utilizes core parameters configurable by the Graphical User Interface (GUI) to setup the core for fixed-mode operation. These configurable options allow the Video Timing Controller core to be easily integrated with AXI4 based processor systems, with non-AXI4-compliant processors systems with some additional logic, and in systems without a processor.

The Video Timing Controller core supports detecting video frame sizes up to 8192 clocks by 8192 lines (including horizontal and vertical blanking). The detection typically requires three to five input video frames to detect and lock. The Video Timing Controller core automatically detects the timing involved with horizontal/vertical blanks and syncs. The timing of the `active_video` and the `active_chroma` signals are also detected. This allows the user to easily determine the video frame size via the core register (AXI4-Lite) interface. The minimum set of signals used for detection is either vertical blank, horizontal blank and active video or vertical sync, horizontal sync and active video. The polarities of each input signal is also detected and reported via the register interface to allow easy use of each signal once the polarity is known.

The core also supports generating and regenerating (matching the detected input) video frame sizes up to 8192 clocks by 8192 lines (including blanking time). The output can be the same format or a different format as the detected input. This allows detecting one format and generating a different format. The output can also be synchronized to the detected input and has separate signal polarity settings as well. This allows regenerating the input with different signal polarities or with slight timing adjustments (such as delayed or shorted active video).

The Video Timing Controller core supports up to 16 frame sync output signals. These are toggled high for one clock cycle during each frame. These frame syncs allow triggering timing critical hardware processes at different times during a frame.

Applications

- Video Surveillance
- Industrial Imaging
- Video Conferencing
- Machine Vision
- Video Systems requiring timing detection or timing generation

Licensing and Ordering

This Xilinx® LogiCORE™ IP module is provided at no cost under the terms of the [Xilinx Core License Agreement](#). The module is shipped as part of the Vivado® Design Suite. For full access to all core functionalities in simulation and in hardware, you must purchase a license for the core. Contact your [local Xilinx sales representative](#) for information about pricing and availability.

For more information, visit the Video Timing Controller product web page.

Information about other Xilinx LogiCORE IP modules is available at the [Xilinx Intellectual Property](#) page. For information on pricing and availability of other Xilinx LogiCORE IP modules and tools, contact your [local Xilinx sales representative](#).

Product Specification

Standards

The Video Timing Controller core is compliant with the AXI4-Lite interconnect standards. Refer to the *Video IP: AXI Feature Adoption* section of the *Vivado AXI Reference Guide* (UG1037) [Ref 1] for additional information.

Performance

The following sections detail the performance characteristics of the Video Timing Controller core.

Maximum Frequencies

This section contains typical clock frequencies for the target devices. The maximum achievable clock frequency can vary. The maximum achievable clock frequency and all resource counts can be affected by other tool options, additional logic in the FPGA device, using a different version of Xilinx tools and other factors.

- Virtex®-7, Kintex®-7, Zynq®-7000 (XC7Z030, XC7Z045) Devices: 225 MHz
- Artix®-7, Zynq-7000 (XC7Z010, XC7Z020) Devices: 150 MHz
- Kintex UltraScale™, Kintex UltraScale+™ (XKU035, XCKU15P) Devices: 400 MHz.

Latency

The Video Timing Controller core does not read or generate data, and therefore, does not have a specific data latency.

The Video Timing Controller core monitors and generates control signals. The output control signals can be configured to be the same as the input with no latency, or the output signals can be configured to incur a multi-clock or multi-line delay.

Throughput

The Video Timing Controller core does not read or generate data, and does not have a specific throughput.

Resource Utilization

For details about resource utilization, visit [Performance and Resource Utilization](#).

Core Interfaces and Register Space

This chapter provides detailed descriptions for each interface. In addition, detailed information about configuration and control registers is included.

Port Descriptions

The Video Timing Controller (VTC) core uses the AXI4-Lite industry standard control interface to connect to other system components. The following sections describe the various interfaces available with the core. Some signals are optional and not present for all configurations of the core. The AXI4-Lite interface and the IRQ pin are present only when the core is configured via the GUI with an AXI4-Lite control interface. The INTC_IF interface is present only when the core is configured via the GUI with the INTC interface enabled. [Figure 2-1](#) illustrates an I/O diagram of the VTC core.

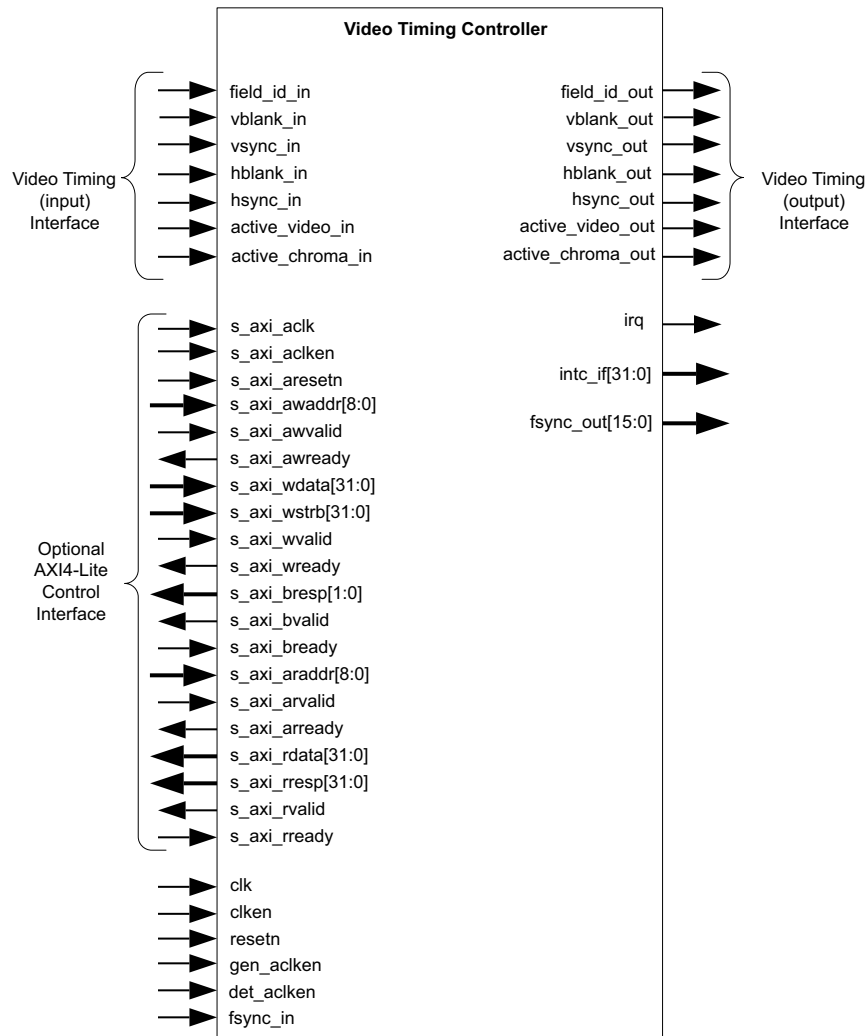

Figure 2-1: TC Core Top-Level Signaling Interface

Core Interfaces

Control Interface

Video systems commonly use an integrated processor system to dynamically control the parameters within the system. This is especially important when several independent image processing cores are integrated into a single FPGA. The Video Timing Controller core can be configured with an AXI4-Lite interface.

Common I/O Signals

The signals not included in the AXI4-Lite interface are specified in [Table 2-1](#).

Table 2-1: Common Port Descriptions

Name	Direction	Width	Description
clk	In	1	Video Core Clock
clken	In	1	Video Core active-High Clock Enable
det_clken	In	1	Video Timing Detection Core active-High Clock Enable
gen_clken	In	1	Video Timing Generator Core active-High Clock Enable
resetsn	In	1	Video Core active-Low Synchronous Reset
irq	Output	1	Interrupt request output, active-High edge
intc_if	Output	32	OPTIONAL EXTERNAL INTERRUPT CONTROLLER INTERFACE Available when the "Include INTC Interface" or C_HAS_INTC_IF has been selected. Bits [31:8] are the same as the bits [31:8] in the status register (0x0004). Bits [5:0] are the same as bits [21:16] of the error register (0x0008). Bits [7:6] are reserved and are always 0.
Detector Interface (Video Timing Input Interface)			
field_id_in	Input	1	INPUT FIELD ID Used to set the field_id polarity in the Detector Polarity Register (Address Offset 0x002C). Optional. Only valid when interlace support and field id are enabled.
hsync_in	Input	1	INPUT HORIZONTAL SYNCHRONIZATION Used to set the DETECTOR HSYNC register. Polarity is auto-detected. Optional. Either horizontal blank or horizontal synchronization signal inputs must be present. Both do not have to be present. If the hsync_in input is not connected, then the "Horizontal Sync Detection" option must be deselected.
hblank_in	Input	1	INPUT HORIZONTAL BLANK Used to set the DETECTOR HSIZE register. Polarity is auto-detected. Optional. Either horizontal blank or horizontal synchronization signal inputs must be present. Both do not have to be present. If the hblank_in input is not connected, then the "Horizontal Blank Detection" option must be deselected.

Table 2-1: Common Port Descriptions (Cont'd)

Name	Direction	Width	Description
vsync_in	Input	1	INPUT VERTICAL SYNCHRONIZATION Used to set the DETECTOR F0_VSYNC_V and the F0_VSYNC_H registers. Polarity is auto-detected. Optional. One of the following inputs must be present: active video, vertical blank or vertical synchronization. If the vsync_in input is not connected, then the "Vertical Sync Detection" option must be deselected.
vblank_in	Input	1	INPUT VERTICAL BLANK Used to set the DETECTOR_VSIZE and the F0_VBLANK_H registers. Polarity is auto-detected. Optional. One of the following inputs must be present: active video, vertical blank or vertical synchronization. If the vblank_in input is not connected, then the "Vertical Blank Detection" option must be deselected.
active_video_in	Input	1	INPUT ACTIVE VIDEO Used to set the DETECTOR_ACTIVE_SIZE register. Polarity is auto-detected. Optional. One of the following inputs must be present: active video, vertical blank or vertical synchronization. If the active_video_in input is not connected, then the "Active Video Detection" option must be deselected.
active_chroma_in	Input	1	INPUT ACTIVE CHROMA Used to set the VIDEO_FORMAT and the CHROMA_PARITY bits in the Detector Encoding Register. Polarity is auto-detected. Optional. If the active_chroma_in input is not connected, then the "Active Chroma Detection" option must be deselected.
Generator Interface (Video Timing Output Interface)			
field_id_out	Output	1	OUTPUT FIELD ID Generated field id signal. Polarity configured by the Generator Polarity Register (Address Offset 0x006C) Optional. Only enabled when interlaced support and field id generation is enabled.
hsync_out	Output	1	OUTPUT HORIZONTAL SYNCHRONIZATION Generated horizontal synchronization signal. Polarity configured by the control register. Asserted active during the cycle set by the HSYNC_START bits and deasserted during the cycle set by the HSYNC_END bits in the GENERATOR HSYNC register.
hblank_out	Output	1	OUTPUT HORIZONTAL BLANK Generated horizontal blank signal. Polarity configured by the control register. Asserted active during the cycle set by ACTIVE_HSIZE and deasserted during the cycle set by the FRAME_HSIZE bits in the GENERATOR HSIZE register.

Table 2-1: Common Port Descriptions (Cont'd)

Name	Direction	Width	Description
vsync_out	Output	1	OUTPUT VERTICAL SYNCHRONIZATION Generated vertical synchronization signal. Polarity configured by the control register. Asserted active during the line set by the F#_VSYNC_VSTART bits and deasserted during the line set by the F#_VSYNC_VEND bits in the GENERATOR F#_VSYNC_V registers.
vblank_out	Output	1	OUTPUT VERTICAL BLANK Generated vertical blank signal. Polarity configured by the control register. Asserted active during the line set by the ACTIVE_VSIZE bits and deasserted during the line set by the GENERATOR VSIZE register.
active_video_out	Output	1	OUTPUT ACTIVE VIDEO Generated active video signal. Polarity configured by the control register. Active for non blanking lines. Asserted active during the first cycle of the field/frame and deasserted during the cycle set by the GENERATOR ACTIVE_SIZE register
active_chroma_out	Output	1	OUTPUT ACTIVE CHROMA Generated active chroma signal. Denotes which lines contain valid chroma samples (used for YUV 4:2:0). Polarity configured by the GENERATOR POLARITY register. Active for non-blanking lines configured y the VIDEO_FORMAT and the CHROMA_PARITY bits in the GENERATOR Encoding Register.
Frame Synchronization Interface			
fsync_out	Output	[Frame Syncs - 1:0]	FRAME SYNCHRONIZATION OUTPUT Each Frame Synchronization bit toggles for only one clock cycle during each frame. The number of bits is configured with the Frame Syncs GUI parameter. Each bit is independently configured for horizontal and vertical clock cycle position with the Frame Sync 0-15 Config registers).
fsync_in	Input	1	FRAME SYNCHRONIZATION INPUT This is a one clock cycle pulse (active-High) input. The video timing generator will be synchronized to the input if used.

Notes:

1. All ports are little-endian.

The `clk`, `clken` and `resetsn`, `det_clken`, and `gen_clken` signals are shared between the core and the Video Timing interfaces. The AXI4-Lite control interface has its own set of clock, clock enable and reset pins: `S_AXI_ACLK`, `S_AXI_ACLKEN` and `S_AXI_ARESETn`.

The clk Pin

The Video Timing interfaces must be synchronous to the core clock signal `clk`. All Video Timing interface input signals are sampled on the rising edge of `clk`. All Video Timing output signal changes occur after the rising edge of `clk`. If the `clk` signal is not running, the AXI4-Lite interface asserts the slave error response (0x2) for all addresses. The `clken` pin is an active-high, synchronous clock-enable input pertaining to Video Timing interfaces.

Setting `clken` low (de-asserted) halts the operation of the core despite rising edges on the `clk` pin. Internal states are maintained, and output signal levels are held until `clken` is asserted again. When `clken` is de-asserted, core inputs are not sampled, except `resetn`, which supersedes `clken`. This clock must be running for AXI4-Lite registers to be read and/or written, since all core registers reside within the core clock domain. This clock enable must be asserted high for AXI4-Lite registers to be read and/or written, since all core registers reside within the core clock domain. If the clock enable is deasserted, the AXI4-Lite interface asserts the slave error response (0x2) for all addresses.

The `det_clken` Pin

The `det_clken` pin is an active-High, synchronous clock-enable pertaining to the Video Timing Controller detector (input) interface. This clock enable allows halting the detector independently from the generator. The internal detector clock enable is a logical "AND" between the `clken` and `det_clken` inputs. The internal logic that controls the detector sub-core clock enable is shown in [Figure 2-2](#).

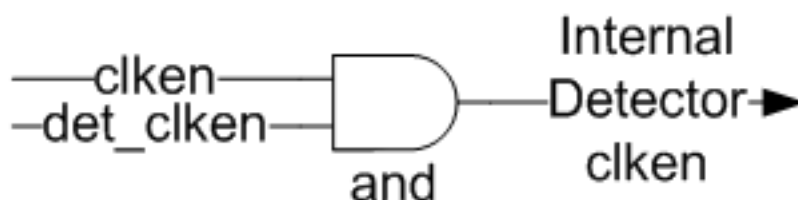

Figure 2-2: Detector Internal Clock Enable Logic

The `gen_clken` Pin

The `gen_clken` pin is an active-High, synchronous clock-enable pertaining to the Video Timing Controller generator (output) interface. This clock enable allows halting the generator independently from the detector. The internal generator clock enable is a logical "AND" between the `clken` and `gen_clken` inputs. For example, to enable the detector while halting the generator, drive `clken` to '1', `det_clken` to '1' and `gen_clken` to '0'. The internal logic that controls the generator sub-core clock enable is shown in [Figure 2-3](#).

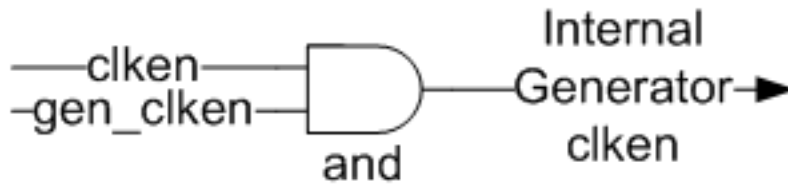

Figure 2-3: Generator Internal Clock Enable Logic

The resetn Pin

The `resetn` pin is an active-Low, synchronous reset input pertaining to only Video Timing interfaces. `resetn` supersedes `clken`, and when set to 0, the core resets at the next rising edge of `clk` even if `clken` is de-asserted. The `resetn` signal must be synchronous to the `clk` and must be held low for a minimum of 32 clock cycles of the slowest clock. This reset must be asserted high for AXI4-Lite registers to be read and/or written, since all core registers reside within the core clock domain. If the reset is asserted low, the AXI4-Lite interface asserts the slave error response (0x2) for all addresses.

The fsync_in Pin

The `fsync_in` pin is an active-High input. The video timing generator is synchronized to the `fsync_in` input if used. The `fsync_in` should be driven high for only one clock cycle per frame. This resets all internal generator counters and starts the generated frame timing synchronized to this input. Internally, the `fsync_in` pin is logically "OR" combined with the internal frame sync `det_fsync`, produced by the detector. The internal frame sync `det_fsync` is generated by the video timing detector and can be used to synchronize the generator timing to the detector timing. The internal logic for this is show in Figure 2-4. If the `fsync_in` input is used, then the detector must be disabled. Likewise, if the detector is used, then the `fsync_in` pin must be driven to '0'. The use of the external `fsync_in` pin and the detector can be changed at run-time but it is important that `fsync_in` and `det_fsync` are never asserted simultaneously.

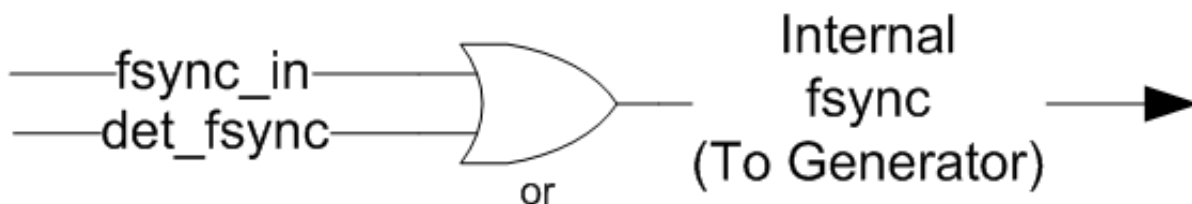

Figure 2-4: Video Timing Controller Internal fsync Logic

AXI4-Lite Interface

The AXI4-Lite interface creates a core that can be easily added to an Vivado Project as a processor peripheral. This section describes the I/O signals associated with the Video Timing Controller AXI4-Lite interface.

Table 2-2: AXI4-Lite Signals

Pin Name	Dir	Width	Description
AXI Write Address Channel Signals⁽¹⁾			
s_axi_aclk	I	1	AXI4-Lite Clock
s_axi_aclken	I	1	AXI4-Lite active-High Clock Enable
s_axi_aresetn	I	1	AXI4-Lite active-Low Synchronous Reset
s_axi_awaddr	I	[(c_s_axi_addr_width-1):0]	AXI4-Lite Write Address Bus. The write address bus gives the address of the write transaction.
s_axi_awvalid	I	1	AXI4-Lite Write Address Channel Write Address Valid. This signal indicates that valid write address is available. 1 = Write address is valid. 0 = Write address is not valid.
s_axi_awready	O	1	AXI4-Lite Write Address Channel Write Address Ready. Indicates core is ready to accept the write address. 1 = Ready to accept address. 0 = Not ready to accept address.
AXI Write Data Channel Signals⁽¹⁾			
s_axi_wdata	I	[(c_s_axi_data_width-1):0]	AXI4-Lite Write Data Bus.
s_axi_wstrb	I	[c_s_axi_data_width/8-1:0]	AXI4-Lite Write Strobes. This signal indicates which byte lanes to update in memory.
s_axi_wvalid	I	1	AXI4-Lite Write Data Channel Write Data Valid. This signal indicates that valid write data and strobes are available. 1 = Write data/strobes are valid. 0 = Write data/strobes are not valid.
s_axi_wready	O	1	AXI4-Lite Write Data Channel Write Data Ready. Indicates core is ready to accept the write data. 1 = Ready to accept data. 0 = Not ready to accept data.
s_axi_wready	O	1	AXI4-Lite Write Data Channel Write Data Ready. Indicates core is ready to accept the write data. 1 = Ready to accept data. 0 = Not ready to accept data.

Table 2-2: AXI4-Lite Signals (Cont'd)

AXI Write Response Channel Signals ⁽¹⁾			
s_axi_bresp ⁽²⁾	O	[1:0]	AXI4-Lite Write Response Channel. Indicates results of the write transfer. 00b = OKAY - Normal access has been successful. 01b = EXOKAY - Not supported. 10b = SLVERR - Error. 11b = DECERR - Not supported.
s_axi_bvalid	O	1	AXI4-Lite Write Response Channel Response Valid. Indicates response is valid. 1 = Response is valid. 0 = Response is not valid.
s_axi_bready	I	1	AXI4-Lite Write Response Channel Ready. Indicates Master is ready to receive response. 1 = Ready to receive response. 0 = Not ready to receive response.
AXI Read Address Channel Signals ⁽¹⁾			
s_axi_araddr	I	[(C_S_AXI_ADDR_WIDTH-1):0]	AXI4-Lite Read Address Bus. The read address bus gives the address of a read transaction.
s_axi_arvalid	I	1	AXI4-Lite Read Address Channel Read Address Valid. 1 = Read address is valid. 0 = Read address is not valid.
s_axi_arready	O	1	AXI4-Lite Read Address Channel Read Address Ready. Indicates core is ready to accept the read address. 1 = Ready to accept address. 0 = Not ready to accept address.
AXI Read Data Channel Signals ⁽¹⁾			
s_axi_rdata	O	[(C_S_AXI_DATA_WIDTH-1):0]	AXI4-Lite Read Data Bus.
s_axi_rresp ⁽²⁾	O	[1:0]	AXI4-Lite Read Response Channel Response. Indicates results of the read transfer. 00b = OKAY - Normal access has been successful. 01b = EXOKAY - Not supported. 10b = SLVERR - Error. 11b = DECERR - Not supported.
s_axi_rvalid	O	1	AXI4-Lite Read Data Channel Read Data Valid. This signal indicates that the required read data is available and the read transfer can complete. 1 = Read data is valid. 0 = Read data is not valid.

Table 2-2: AXI4-Lite Signals (Cont'd)

s_axi_rready	I	1	AXI4-Lite Read Data Channel Read Data Ready. Indicates master is ready to accept the read data. 1 = Ready to accept data. 0 = Not ready to accept data.
--------------	---	---	---

Notes:

- The function and timing of these signals are defined in the AMBA AXI Protocol Version: 2.0 Specification.
- For signals S_AXI_RRESP[1:0] and S_AXI_BRESP[1:0], the core does not generate the Decode Error ('11') response. Other responses such as '00' (OKAY) and '10' (SLVERR) are generated by the core based upon certain conditions.

Notes:

- The function and timing of these signals are defined in the AMBA AXI Protocol Version: 2.0 Specification.
- For signals S_AXI_RRESP[1:0] and S_AXI_BRESP[1:0], the core does not generate the Decode Error ('11') response. Other responses such as '00' (OKAY) and '10' (SLVERR) are generated by the core based upon certain conditions.

AXI4-Lite Register Set

The AXI4-Lite Interface provides a memory mapped interface for all programmable registers within the core. All registers default to the values specified in Page 2 of the core GUI. All other bits default to 0x00000000 on Power-on/Reset unless otherwise noted. For complete detailed register description, refer from [Table 2-4](#) to [Table 2-37](#).

Table 2-3: AXI4-Lite Address Map

Address Offset	Name	Access Type	Double Buffered	Default Value	Description
0x0000	CONTROL (XVTC_CTL)	R/W	Yes	0	General Control
0x0004	STATUS (XVTC_STATS)	R/W	No	0	Core/Interrupt Status All Status bits are write-1-to-clear
0x0008	ERROR (XVTC_ERROR)	R/W	No	0	Additional Status & Error Conditions All Error bits are write-1-to-clear
0x000C	IRQ_ENABLE (XVTC_IER)	R/W	No	0	Interrupt Enable/Clear
0x0010	VERSION (XVTC_VER)	R	N/A	0x06010001	Core Hardware Version
0x0014 ... 0x001C	RESERVED	R	N/A	0	RESERVED
0x0020	DETECTOR ACTIVE_SIZE (XVTC_DASIZE)	R	N/A	0	Horizontal and Vertical Frame Size (without blanking)

Table 2-3: AXI4-Lite Address Map (Cont'd)

Address Offset	Name	Access Type	Double Buffered	Default Value	Description
0x0024	DETECTOR TIMING_STATUS (XVTC_DTSTAT)	R	N/A	0	Timing Measurement Status
0x0028	DETECTOR ENCODING (XVTC_DFENC)	R	N/A	0	Frame encoding
0x002C	DETECTOR POLARITY (XVTC_DPOL)	R	N/A	0	Blank, Sync polarities
0x0030	DETECTOR HSIZE (XVTC_DHSIZE)	R	N/A	0	Horizontal Frame Size (with blanking)
0x0034	DETECTOR VSIZE (XVTC_DVSIZE)	R	N/A	0	Vertical Frame Size (with blanking)
0x0038	DETECTOR HSYNC (XVTC_DHSYNC)	R	N/A	0	Start and end cycle index of HSync
0x003C	DETECTOR F0_VBLANK_H (XVTC_DVBHOFF)	R	N/A	0	Start and end cycle index of VBlank for field 0.
0x0040	DETECTOR F0_VSYNC_V (XVTC_DVSYNC)	R	N/A	0	Start and end line index of VSync for field 0.
0x0044	DETECTOR F0_VSYNC_H (XVTC_DVSHOFF)	R	N/A	0	Start and end cycle index of VSync for field 0.
0x0048	DETECTOR F1_VBLANK_H (XVTC_DVBHOFF_F1)	R	N/A	0	Start and end cycle index of VBlank for field 1.
0x004C	DETECTOR F1_VSYNC_V (XVTC_DVSYNC_F1)	R	N/A	0	Start and end line index of VSync for field 1.
0x0050	DETECTOR F1_VSYNC_H (XVTC_DVSHOFF_F1)	R	N/A	0	Start and end cycle index of VSync for field 1.
0x0060	GENERATOR ACTIVE_SIZE (XVTC_GASIZE_F0)	R/W	Yes	Specified via GUI	Horizontal and Vertical Frame Size (without blanking) for field 0.
0x0064	GENERATOR TIMING_STATUS (XVTC_GTSTAT)	R	No	Specified via GUI	Timing Measurement Status
0x0068	GENERATOR ENCODING (XVTC_GFENC)	R/W	Yes	Specified via GUI	Frame encoding
0x006C	GENERATOR POLARITY (XVTC_GPOL)	R/W	Yes	Specified via GUI	Blank, Sync polarities

Table 2-3: AXI4-Lite Address Map (Cont'd)

Address Offset	Name	Access Type	Double Buffered	Default Value	Description
0x0070	GENERATOR HSIZE (XVTC_GHSIZE)	R/W	Yes	Specified via GUI	Horizontal Frame Size (with blanking)
0x0074	GENERATOR VSIZE (XVTC_GVSIZE)	R/W	Yes	Specified via GUI	Vertical Frame Size (with blanking)
0x0078	GENERATOR HSYNC (XVTC_GHSYNC)	R/W	Yes	Specified via GUI	Start and end cycle index of HSync
0x007C	GENERATOR F0_VBLANK_H (XVTC_GVBHOFF)	R/W	Yes	Specified via GUI	Start and end cycle index of VBlank for field 0.
0x0080	GENERATOR F0_VSYNC_V (XVTC_GVSYNC)	R/W	Yes	Specified via GUI	Start and end line index of VSync for field 0.
0x0084	GENERATOR F0_VSYNC_H (XVTC_GVSHOFF)	R/W	Yes	Specified via GUI	Start and end cycle index of VSync for field 0.
0x0088	GENERATOR F1_VBLANK_H (XVTC_GVBHOFF_F1)	R/W	Yes	Specified via GUI	Start and end cycle index of VBlank for field 1.
0x008C	GENERATOR F1_VSYNC_V (XVTC_GVSYNC_F1)	R/W	Yes	Specified via GUI	Start and end line index of VSync for field 1.
0x0090	GENERATOR F1_VSYNC_H (XVTC_GVSHOFF_F1)	R/W	Yes	Specified via GUI	Start and end cycle index of VSync for field 1.
0x0094	GENERATOR ACTIVE_SIZE (XVTC_GASIZE_F1)	R/W	Yes	Specified via GUI	Horizontal and Vertical Frame size for field 1.
0x0095 ... 0x00FC	RESERVED	R	N/A	0	RESERVED
0x0100 ... 0x013c	FRAME SYNC 0 - 15 CONFIG (XVTC_FS00 - XVTC_FS15)	R/W	Yes	0	Horizontal start clock and vertical start line of Frame Sync 0 - 15
0x0140	GENERATOR GLOBAL DELAY (XVTC_GGD)	R/W	Yes	0	Horizontal cycle and vertical line delay of generator.

Table 2-4: Control Register (Address Offset 0x0000)

0x0000	CONTROL	Read/Write
Name	Bits	Description
SW_RESET	31	Core reset. Writing a '1' resets the core. This bit automatically clears when reset complete.
FSYNC_RESET	30	Frame Sync Core reset. Writing a '1' resets the core after the start of the next input frame. This bit automatically clears when reset complete.
RESERVED	29:27	Reserved
FIELD_ID_POL_SRC	26	Field ID Polarity Source Select 0: selects generated polarity from detection register (0x002c) 1: selects generated polarity from generators register (0x006c)
ACTIVE_CHROMA_POL_SRC	25	Active Chroma Polarity Source Select 0: selects generated polarity from detection register (0x002c) 1: selects generated polarity from generator register (0x006c)
ACTIVE_VIDEO_POL_SRC	24	Active Video Polarity Source Select 0: selects generated polarity from detection register (0x002c) 1: selects generated polarity from generator register (0x006c)
HSYNC_POL_SRC	23	Horizontal Sync Polarity Source Select 0: selects generated polarity from detection register (0x002c) 1: selects generated polarity from generator register (0x006c)
VSYNC_POL_SRC	22	Vertical Sync Polarity Source Select 0: selects generated polarity from detection register (0x002c) 1: selects generated polarity from generator register (0x006c)
HBLANK_POL_SRC	21	Horizontal Blank Polarity Source Select 0: selects generated polarity from detection register (0x002c) 1: selects generated polarity from generator register (0x006c)
VBLANK_POL_SRC	20	Vertical Blank Polarity Source Select 0: selects generated polarity from detection register (0x002c) 1: selects generated polarity from generator register (0x006c)
RESERVED	19	RESERVED
CHROMA_SRC	18	Generator Chroma Polarity and Encoding Source Select 0: selects Polarity and encoding from detection registers 0x0028 and 0x002C. 1: selects Polarity and encoding from generator registers 0x0068 and 0x006C.
VBLANK_HOFF_SRC	17	Generator Vertical Blank Offset Source Select 0: selects F0_VBLANK_HSTART from detection register (0x003c) selects F0_VBLANK_HEND from detection register (0x003c) 1: selects F0_VBLANK_HSTART from generator register (0x007c) selects F0_VBLANK_HEND from generator register (0x007c)

Table 2-4: Control Register (Address Offset 0x0000) (Cont'd)

0x0000	CONTROL	Read/Write
Name	Bits	Description
VSYNC_END_SRC	16	Generator Vertical Sync End Source Select 0: selects F0_VSYNC_HEND from detection register (0x0044) selects F0_VSYNC_VEND from detection register (0x0040) 1: selects F0_VSYNC_HEND from generator register (0x0084) selects F0_VSYNC_VEND from generator register (0x0080)
VSYNC_START_SRC	15	Generator Vertical Sync Start Source Select 0: selects F0_VSYNC_HSTART from detection register (0x0044) selects F0_VSYNC_VSTART from detection register (0x0040) 1: selects F0_VSYNC_HSTART from generator register (0x0084) selects F0_VSYNC_VSTART from generator register (0x0080)
ACTIVE_VSIZE_SRC	14	Generator Vertical Active Size Source Select 0: selects ACTIVE_VSIZE from detection register (0x0020) 1: selects ACTIVE_VSIZE from generator register (0x0060)
FRAME_VSIZE_SRC	13	Generator Vertical Frame Size Source Select 0: selects FRAME_VSIZE from detection register (0x0034) 1: selects FRAME_VSIZE from generator register (0x0074)
RESERVED	12	Reserved
HSYNC_END_SRC	11	Generator Horizontal Sync End Source Select 0: selects HSYNC_END from detection register (0x0038) 1: selects HSYNC_END from generator register (0x0078)
HSYNC_START_SRC	10	Generator Horizontal Sync Start Source Select 0: selects HSYNC_START from detection register (0x0038) 1: selects HSYNC_START from generator register (0x0078)
ACTIVE_HSIZE_SRC	9	Generator Horizontal Active Size Source Select 0: selects ACTIVE_HSIZE from detection register (0x0020) 1: selects ACTIVE_HSIZE from generator register (0x0060)
FRAME_HSIZE_SRC	8	Generator Horizontal Frame Size Source Select 0: selects FRAME_HSIZE from detection register (0x0030) 1: selects FRAME_HSIZE from generator register (0x0070)
RESERVED	7:6	Reserved
SYNC_ENABLE	5	Generator Synchronization Enable. Enables the generator to synchronize to the Detector or to the fsync_in pin. 1: Generator synchronizes to the Detector or to fsync_in 0: Generator does not synchronize.
RESERVED	4	Reserved
DET_ENABLE	3	Detection Enable. 1: Perform timing signal detection for enabled signals. 0: If SW_ENABLE is '0', No detection will be performed. All 'locked' status bits will be driven low. SW_ENABLE must be '0' to utilize the DET_ENABLE bit. If SW_ENABLE is '1', both the detector and generator will be enabled.

Table 2-4: Control Register (Address Offset 0x0000) (Cont'd)

0x0000	CONTROL	Read/Write
Name	Bits	Description
GEN_ENABLE	2	Generation Enable. 1: Enable hardware to generate output. Set this bit high only after the software has configured the generator registers. 0: If SW_ENABLE is '0', The generation hardware will not generate video timing output signals. SW_ENABLE must be '0' to utilize the DET_ENABLE bit. If SW_ENABLE is '1', both the detector and generator will be enabled.
REG_UPDATE	1	Register Update. Generator and Fsync Registers are double-buffered. 1: Update the Generator and Fsync registers at the start of next frame. 0: Do not update the Generator and Fsync registers.
SW_ENABLE	0	Core Enable. 1: Enable both the Video Timing Generator and Detector. 0: Generator or Detector can be selectively enabled with bits 2 and 3 of the CONTROL register.

The DET_ENABLE bit allows enabling the detector independently from the generator. The internal detector enable is a logical "OR" between the DET_ENABLE and SW_ENABLE bits in the control register. The internal logic that controls the detector sub-core enable is shown in Figure 2-5. The SW_ENABLE bit allows setting one bit to '1' to enable both the detector and the generator. To enable the detector or the generator only, the SW_ENABLE bit must be set to '0' and the detector/generator ENABLE bits (Control Register bits [3:2]) set independently.

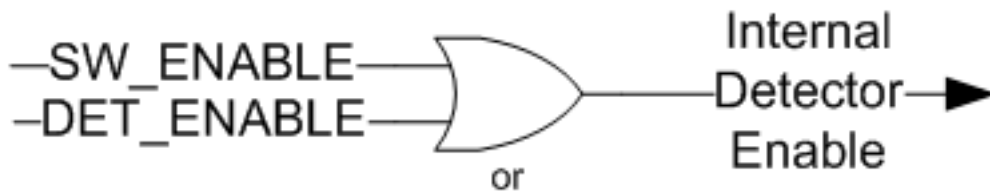

Figure 2-5: Detector Internal Enable Logic

The internal generator enable is a logical "OR" between the GEN_ENABLE and SW_ENABLE bits in the control register. The internal logic that controls the generator sub-core enable is shown in Figure 2-6.

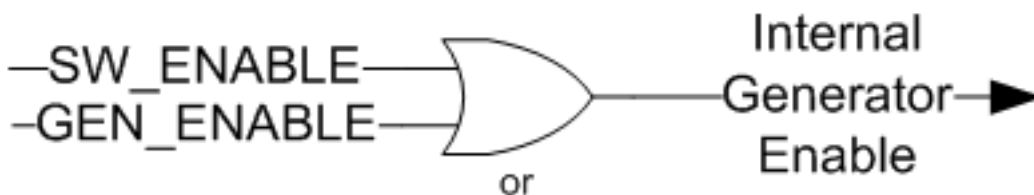

Figure 2-6: Generator Internal Enable Logic

Table 2-5: Status Register (Address Offset 0x0004)

0x0004	STATUS	Read/Write
Name	Bits	Description
FSYNC	31:16	Frame Synchronization Interrupt Status. Bits 16-31 are set high when frame syncs 0-15 are set respectively.
RESERVED	15:14	Reserved
GEN_ACTIVE_VIDEO	13	Generated Active Video Interrupt Status. Set high during the first cycle the output active video is asserted.
GEN_VBLANK	12	Generated Vertical Blank Interrupt Status. Set high during the first cycle the output vertical blank is asserted.
DET_ACTIVE_VIDEO	11	Detected Active Video Interrupt Status. Set high during the first cycle the input active video is asserted active after lock.
DET_VBLANK	10	Detected Vertical Blank Interrupt Status. Set high during the first cycle the input vertical blank is asserted active after lock.
LOCK_LOSS	9	Loss-of-Lock Status. Set High when any detection signals have lost locked. Signals that have detection disabled will not affect this bit. Check ERROR (0x0008) Register for signal lock status.
LOCK	8	Lock Status. Set High when all detection signals have locked. Signals that have detection disabled will not affect this bit. Check ERROR (0x0008) Register for signal lock status. The detector typically takes from 3 to 5 video frame periods to lock onto the incoming video standard.
RESERVED	7:0	Reserved

Notes:

1. Writing a '1' to a bit in the STATUS register will clear the corresponding interrupt when set. Writing a '1' to a bit that is cleared, will have no effect.

Table 2-6: Error Register (Address Offset 0x0008)

0x0008	ERROR	Read/Write
Name	Bits	Description
RESERVED	31:22	Reserved
ACTIVE_CHROMA_LOCK	21	Active Chroma Lock Status. Set high when the active chroma timing remains unchanged.

Table 2-6: Error Register (Address Offset 0x0008)

0x0008	ERROR	Read/Write
Name	Bits	Description
ACTIVE_VIDEO_LOCK	20	Active Video Lock Status. Set high when the active video timing remains unchanged.
HSYNC_LOCK	19	Horizontal Sync Lock Status. Set high when the horizontal sync timing remains unchanged.
VSYNC_LOCK	18	Vertical Sync Lock Status. Set high when the vertical sync timing remains unchanged.
HBLANK_LOCK	17	Horizontal Blank Lock Status. Set high when the horizontal blank timing remains unchanged.
VBLANK_LOCK	16	Vertical Blank Lock Status Set high when the vertical blank timing remains Unchanged.
RESERVED	15:0	Reserved

Notes:

- Writing a '1' to a bit in the ERROR register will clear the corresponding bit when set. Writing a '1' to a bit that is cleared, will have no effect.

Table 2-7: IRQ Enable Register (Address Offset 0x000C)

0x000C	IRQ_ENABLE	Read/Write
Name	Bits	Description
FSYNC	31:16	Frame Synchronization Interrupt Enable
RESERVED	15:14	Reserved
GEN_ACTIVE_VIDEO	13	Generated Active Video Interrupt Enable
GEN_VBLANK	12	Generated Vertical Blank Interrupt Enable
DET_ACTIVE_VIDEO	11	Detected Active Video Interrupt Enable
DET_VBLANK	10	Detected Vertical Blank Interrupt Enable
LOCK_LOSS	9	Loss-of-Lock Interrupt Enable
LOCK	8	Lock Interrupt Enable
RESERVED	7:0	Reserved

Notes:

- Setting a bit high in the IRQ_ENABLE register enables the corresponding interrupt. Bits that are low mask the corresponding interrupt from triggering.

Table 2-8: Version Register (Address Offset 0x0010)

0x0010	VERSION	Read
Name	Bits	Description
MAJOR	31:24	Major version as a hexadecimal value (0x00 - 0xFF)
MINOR	23:16	Minor version as a hexadecimal value (0x00 - 0xFF)
REVISION	15:12	Revision as a hexadecimal value (0x0 - 0xF)

Table 2-8: Version Register (Address Offset 0x0010) (Cont'd)

0x0010	VERSION	Read
Name	Bits	Description
PATCH_REVISION	11:8	Core Revision as a single 4-bit hexadecimal value (0x0 - 0xF) Used for patch tracking.
INTERNAL_REVISION	7:0	Internal revision number. Hexadecimal value (0x00 - 0xFF)

Table 2-9: Detector Active Size Register (Address Offset 0x0020)

0x0020	DETECTOR ACTIVE_SIZE	Read
Name	Bits	Description
RESERVED	31:29	Reserved
ACTIVE_VSIZE	28:16	Detected Vertical Active Frame Size. The height of the frame without blanking in number of lines.
RESERVED	15:13	Reserved
ACTIVE_HSIZE	12:0	Detected Horizontal Active Frame Size. The width of the frame without blanking in number of pixels/clocks.

Table 2-10: Detector Timing Status Register (Address Offset 0x0024)

0x0024	DETECTOR TIMING_STATUS	Read
Name	Bits	Description
RESERVED	31:3	Reserved
DET_ACTIVE_VIDEO	2	Detected Active Video Interrupt Status. Set high during the first cycle the input active video is asserted active after lock.
DET_VBLANK	1	Detected Vertical Blank Interrupt Status. Set high during the first cycle the input vertical blank is asserted active after lock.
LOCKED	0	Lock Status. Set High when all detection signals have locked. Signals that have detection disabled will not affect this bit. Check ERROR (0x0008) Register for which signal lock status. The detector typically requires 3 to 5 video frame periods to lock onto the incoming video standard. This bit will not latch the lock status, thus, it shows the real-time status of lock as opposed to the LOCKED bit in the Status Register which must be cleared.

Table 2-11: Detector Encoding Register (Address Offset 0x0028)

0x0028	DETECTOR ENCODING	Read
Name	Bits	Description
RESERVED	31:10	Reserved
CHROMA_PARITY	9:8	Detected Chroma Parity 0: Chroma Active during even active-video lines of frame. Active every pixel of active line 1: Chroma Active during odd active-video lines of frame. Active every pixel of active line 2: Chroma Active during even active video lines of frame. Active every even pixel of active line, inactive every odd pixel 3: Chroma Active during odd active video lines of frame. Active every even pixel of active line, inactive every odd pixel
FIELD_ID_PARITY	7	Detected Field ID Parity 0: Field ID output is currently low 1: Field ID output is currently high
INTERLACED	6	Detected Progressive /Interlaced 0: Input video format is progressive 1: Input video format is interlaced
RESERVED	5:4	Reserved
VIDEO_FORMAT	3:0	Detected Video Format Denotes when the active_chroma signal is active. 0: YUV 4:2:2 - Active_chroma is active during the same time active_video is active. 1: YUV 4:4:4 - Active_chroma is active during the same time active_video is active. 2: RGB - Active_chroma is active during the same time active_video is active. 3: YUV 4:2:0- Active_chroma is active every other line during the same time active_video is active. See The CHROMA_PARITY bits to control which lines and pixels.

Table 2-12: Detector Polarity Register (Address Offset 0x002C)

0x002C	DETECTOR POLARITY	Read
Name	Bits	Description
RESERVED	31:7	Reserved
FIELD_ID_POL	6	Detected Field ID Polarity 0: Low during Field 0 and High during Field 1 1: High during Field 0 and Low during Field 1
ACTIVE_CHROMA_POL	5	Detected Active Chroma Polarity 0: active-Low Polarity 1: active-High Polarity

Table 2-12: Detector Polarity Register (Address Offset 0x002C) (Cont'd)

0x002C	DETECTOR POLARITY	Read
Name	Bits	Description
ACTIVE_VIDEO_POL	4	Detected Active Video Polarity 0: active-Low Polarity 1: active-High Polarity
HSYNC_POL	3	Detected Horizontal Sync Polarity 0: active-Low Polarity 1: active-High Polarity
VSYNC_POL	2	Detected Vertical Sync Polarity 0: active-Low Polarity 1: active-High Polarity
HBLANK_POL	1	Detected Horizontal Blank Polarity 0: active-Low Polarity 1: active-High Polarity
VBLANK_POL	0	Detected Vertical Blank Polarity 0: active-Low Polarity 1: active-High Polarity

Table 2-13: Detector Horizontal Frame Size Register (Address Offset 0x0030)

0x0030	DETECTOR HSIZE	Read
Name	Bits	Description
RESERVED	31:13	Reserved
FRAME_HSIZE	12:0	Detected Horizontal Frame Size. The width of the frame with blanking in number of pixels/clocks.

Table 2-14: Detector Vertical Frame Size Register (Address Offset 0x0034)

0x0034	DETECTOR VSIZE	Read
Name	Bits	Description
RESERVED	31:29	Reserved
FIELD1_VSIZE	28:16	Detected Vertical Field 1 Size. The height with blanking in number of lines of field 1.
FRAME_VSIZE	12:0	Detected Vertical Frame or Field 0 Size. The height of the frame with blanking in number of lines.

Table 2-15: Detector Horizontal Sync Register (Address Offset 0x0038)

0x0038	DETECTOR HSYNC	Read
Name	Bits	Description
RESERVED	31:29	Reserved
HSYNC_END	28:16	Detected Horizontal Sync End End cycle index of horizontal sync. Denotes the first cycle hsync_in is de-asserted.
RESERVED	15:13	Reserved
HSYNC_START	12:0	Detected Horizontal Sync End Start cycle index of horizontal sync. Denotes the first cycle hsync_in is asserted.

Table 2-16: Detector Frame/Field 0 Vertical Blank Cycle Register (Address Offset 0x003C)

0x003C	DETECTOR FO_VBLANK_H	Read
Name	Bits	Description
RESERVED	31:29	Reserved
FO_VBLANK_HEND	28:16	Detected Vertical Blank Horizontal End End Cycle index of vertical blank. Denotes the first cycle vblank_in is de-asserted.
RESERVED	15:13	Reserved
FO_VBLANK_HSTART	12:0	Detected Vertical Blank Horizontal Start Start Cycle index of vertical blank. Denotes the first cycle vblank_in is asserted.

Table 2-17: Detector Frame/Field 0 Vertical Sync Line Register (Address Offset 0x0040)

0x0040	DETECTOR FO_VSYNC_V	Read
Name	Bits	Description
RESERVED	31:29	Reserved
FO_VSYNC_VEND	28:16	Detected Vertical Sync Vertical End End Line index of vertical sync. Denotes the first line vsync_in is de-asserted.
RESERVED	15:13	Reserved
FO_VSYNC_VSTART	12:0	Detected Vertical Sync Vertical Start Start line index of vertical sync. Denotes the first line vsync_in is asserted.

Table 2-18: Detector Frame/Field 0 Vertical Sync Cycle Register (Address Offset 0x0044)

0x0044	DETECTOR F0_VSYNC_H	Read
Name	Bits	Description
RESERVED	31:29	Reserved
F0_VSYNC_HEND	28:16	Detected Vertical Sync Horizontal End End cycle index of vertical sync. Denotes the first cycle vsync_in is de-asserted.
RESERVED	15:13	Reserved
F0_VSYNC_HSTART	12:0	Detected Vertical Sync Horizontal Start Start cycle index of vertical sync. Denotes the first cycle vsync_in is asserted.

Table 2-19: Detector Field 1 Vertical Blank Cycle Register (Address Offset 0x0048)

0x0048	DETECTOR F1_VBLANK_H	Read
Name	Bits	Description
RESERVED	31:29	Reserved
F1_VBLANK_HEND	28:16	Detected Field 1 Vertical Blank Horizontal End End Cycle index of vertical blank for field 1. Denotes the first cycle vblank_in is de-asserted.
RESERVED	15:13	Reserved
F1_VBLANK_HSTART	12:0	Detected Field 1 Vertical Blank Horizontal Start Start Cycle index of vertical blank for field 1. Denotes the first cycle vblank_in is asserted.

Table 2-20: Detector Field 1 Vertical Sync Line Register (Address Offset 0x004C)

0x004C	DETECTOR F1_VSYNC_V	Read
Name	Bits	Description
RESERVED	31:29	Reserved
F1_VSYNC_VEND	28:16	Detected Field 1 Vertical Sync Vertical End End Line index of vertical sync for field 1. Denotes the first line vsync_in is de-asserted.
RESERVED	15:13	Reserved
F1_VSYNC_VSTART	12:0	Detected Field 1 Vertical Sync Vertical Start Start line index of vertical sync for field 1. Denotes the first line vsync_in is asserted.

Table 2-21: Detector Field 1 Vertical Sync Cycle Register (Address Offset 0x0050)

0x0050	DETECTOR F1_VSYNC_H	Read
Name	Bits	Description
RESERVED	31:29	Reserved
F1_VSYNC_HEND	28:16	Detected Field 1 Vertical Sync Horizontal End End cycle index of vertical sync for field 1. Denotes the first cycle vsync_in is de-asserted.
RESERVED	15:13	Reserved
F1_VSYNC_HSTART	12:0	Detected Field 1 Vertical Sync Horizontal Start Start cycle index of vertical sync for field 1. Denotes the first cycle vsync_in is asserted.

Table 2-22: Generator Active Size Register for Field 0 (Address Offset 0x0060)

0x0060	GENERATOR ACTIVE_SIZE	Read/Write
Name	Bits	Description
RESERVED	31:29	Reserved
ACTIVE_VSIZE	28:16	Generated Vertical Active Frame Size. The height of the frame without blanking in number of lines.
RESERVED	15:13	Reserved
ACTIVE_HSIZE	12:0	Generated Horizontal Active Frame Size. The width of the frame without blanking in number of cycles ⁽¹⁾ .

Notes:

1. Cycles must be always divisible by pixels per clock. For example, Cycles (Clocks) = Horizontal Resolution/ Pixels per clock.

Table 2-23: Generator Timing Status Register (Address Offset 0x0064)

0x0064	GENERATOR TIMING_STATUS	Read
Name	Bits	Description
RESERVED	31:3	Reserved
GEN_ACTIVE_VIDEO	2	Generated Active Video Interrupt Status. Set high during the first cycle the output active video is asserted.
GEN_VBLANK	1	Generated Vertical Blank Interrupt Status. Set high during the first cycle the output vertical blank is asserted.
RESERVED	0	Reserved

Table 2-24: Generator Encoding Register (Address Offset 0x0068)

0x0068	GENERATOR ENCODING	Read/Write
Name	Bits	Description
RESERVED	31:10	Reserved
CHROMA_PARITY	9:8	Generated Chroma Parity 0: Chroma Active during even active-video lines of frame. Active every pixel of active line 1: Chroma Active during odd active-video lines of frame. Active every pixel of active line 2: Chroma Active during even active video lines of frame. Active every even pixel of active line, inactive every odd pixel 3: Chroma Active during odd active video lines of frame. Active every even pixel of active line, inactive every odd pixel
FIELD_ID_PARITY	7	Generated Field ID Parity 0: Field ID input is currently low 1: Field ID input is currently high
INTERLACED	6	Generated Progressive/Interlaced 0: Generated video format is progressive 1: Generated video format is interlaced
RESERVED	5:4	Reserved
VIDEO_FORMAT	3:0	Generated Video Format Denotes when the active_chroma signal is active. 0: YUV 4:2:2 - Active_chroma is active during the same time active_video is active. 1: YUV 4:4:4 - Active_chroma is active during the same time active_video is active. 2: RGB - Active_chroma is active during the same time active_video is active. 3: YUV 4:2:0- Active_chroma is active every other line during the same time active_video is active. See The CHROMA_PARITY bits to control which lines and pixels.

Table 2-25: Generator Polarity Register (Address Offset 0x006C)

0x006C	GENERATOR POLARITY	Read/Write
Name	Bits	Description
RESERVED	31:7	Reserved
FIELD_ID_POL	6	Generated Field ID Polarity 0: Low during Field 0 and High during Field 1 1: High during Field 0 and Low during Field 1
ACTIVE_CHROMA_POL	5	Generated Active Chroma Polarity 0: active-Low Polarity 1: active-High Polarity

Table 2-25: Generator Polarity Register (Address Offset 0x006C) (Cont'd)

0x006C	GENERATOR POLARITY	Read/Write
Name	Bits	Description
ACTIVE_VIDEO_POL	4	Generated Active Video Polarity 0: active-Low Polarity 1: active-High Polarity
HSYNC_POL	3	Generated Horizontal Sync Polarity 0: active-Low Polarity 1: active-High Polarity
VSYNC_POL	2	Generated Vertical Sync Polarity 0: active-Low Polarity 1: active-High Polarity
HBLANK_POL	1	Generated Horizontal Blank Polarity 0: active-Low Polarity 1: active-High Polarity
VBLANK_POL	0	Generated Vertical Blank Polarity 0: active-Low Polarity 1: active-High Polarity

Table 2-26: Generator Horizontal Frame Size Register (Address Offset 0x0070)

0x0070	GENERATOR HSIZE	Read/Write
Name	Bits	Description
RESERVED	31:13	Reserved
FRAME_HSIZE	12:0	Generated Horizontal Frame Size. The width of the frame with blanking in number of cycles ⁽¹⁾ .

Notes:

1. Cycles must be always divisible by pixels per clock. For example, Cycles (Clocks) = Horizontal Resolution/ Pixels per clock.

Table 2-27: Generator Vertical Frame Size Register (Address Offset 0x0074)

0x0074	GENERATOR VSIZE	Read/Write
Name	Bits	Description
RESERVED	31:29	Reserved
FIELD1_VSIZE	28:16	Generated Vertical Field 1 Size. The height with blanking in number of lines of field 1.
FRAME_VSIZE	12:0	Generated Vertical Frame Size. The height of the frame with blanking in number of lines.

Table 2-28: Generator Horizontal Sync Register (Address Offset 0x0078)

0x0078	GENERATOR HSYNC	Read/Write
Name	Bits	Description
RESERVED	31:29	Reserved
HSYNC_END	28:16	Generated Horizontal Sync End End cycle index of horizontal sync. Denotes the first cycle hsync_in is de-asserted.
RESERVED	15:13	Reserved
HSYNC_START	12:0	Generated Horizontal Sync End Start cycle index of horizontal sync. Denotes the first cycle hsync_in is asserted.

Table 2-29: Generator Frame/Field 0 Vertical Blank Cycle Register (Address Offset 0x007C)

0x007C	GENERATOR FO_VBLANK_H	Read/Write
Name	Bits	Description
RESERVED	31:29	Reserved
FO_VBLANK_HEND	28:16	Generated Vertical Blank Horizontal End End Cycle index of vertical blank. Denotes the first cycle vblank_in is de-asserted.
RESERVED	15:13	Reserved
FO_VBLANK_HSTART	12:0	Generated Vertical Blank Horizontal Start Start Cycle index of vertical blank. Denotes the first cycle vblank_in is asserted.

Table 2-30: Generator Frame/Field 0 Vertical Sync Line Register (Address Offset 0x0080)

0x0080	GENERATOR FO_VSYNC_V	Read/Write
Name	Bits	Description
RESERVED	31:29	Reserved
FO_VSYNC_VEND	28:16	Generated Vertical Sync Vertical End End Line index of vertical sync. Denotes the first line vsync_in is de-asserted.
RESERVED	15:13	Reserved
FO_VSYNC_VSTART	12:0	Generated Vertical Sync Vertical Start Start line index of vertical sync. Denotes the first line vsync_in is asserted.

Table 2-31: Generator Frame/Field 0 Vertical Sync Cycle Register (Address Offset 0x0084)

0x0084	GENERATOR F0_VSYNC_H	Read/Write
Name	Bits	Description
RESERVED	31:29	Reserved
F0_VSYNC_HEND	28:16	Generated Vertical Sync Horizontal End End cycle index of vertical sync. Denotes the first cycle vsync_in is de-asserted.
RESERVED	15:13	Reserved
F0_VSYNC_HSTART	12:0	Generated Vertical Sync Horizontal Start Start cycle index of vertical sync. Denotes the first cycle vsync_in is asserted.

Table 2-32: Generator Field 1 Vertical Blank Cycle Register (Address Offset 0x0088)

0x0088	GENERATOR F1_VBLANK_H	Read
Name	Bits	Description
RESERVED	31:29	Reserved
F1_VBLANK_HEND	28:16	Generated Field 1 Vertical Blank Horizontal End End Cycle index of vertical blank for field 1. Denotes the first cycle vblank_in is de-asserted.
RESERVED	15:13	Reserved
F1_VBLANK_HSTART	12:0	Generated Field 1 Vertical Blank Horizontal Start Start Cycle index of vertical blank for field 1. Denotes the first cycle vblank_in is asserted.

Table 2-33: Generator Field 1 Vertical Sync Line Register (Address Offset 0x008C)

0x008C	GENERATOR F1_VSYNC_V	Read
Name	Bits	Description
RESERVED	31:29	Reserved
F1_VSYNC_VEND	28:16	Generated Field 1 Vertical Sync Vertical End End Line index of vertical sync for field 1. Denotes the first line vsync_in is de-asserted.
RESERVED	15:13	Reserved
F1_VSYNC_VSTART	12:0	Generated Field 1 Vertical Sync Vertical Start Start line index of vertical sync for field 1. Denotes the first line vsync_in is asserted.

Table 2-34: Generator Field 1 Vertical Sync Cycle Register (Address Offset 0x0090)

0x0090	GENERATOR F1_VSYNC_H	Read
Name	Bits	Description
RESERVED	31:29	Reserved
F1_VSYNC_HEND	28:16	Generated Field 1 Vertical Sync Horizontal End End cycle index of vertical sync for field 1. Denotes the first cycle vsync_in is de-asserted.
RESERVED	15:13	Reserved
F1_VSYNC_HSTART	12:0	Generated Field 1 Vertical Sync Horizontal Start Start cycle index of vertical sync for field 1. Denotes the first cycle vsync_in is asserted.

Table 2-35: Generator Active Size Register for Field 1 (Address Offset 0x0094)

0x0100	FRAME SYNC 0 CONFIG	Read/Write
Name	Bits	Description
RESERVED	31:29	Reserved
ACTIVE_VSIZE	28:16	Generated Vertical Active Frame Size. The height of the frame without blanking in number of lines.
RESERVED	15:13	Reserved
ACTIVE_HSIZE	12:0	Generated Horizontal Active Frame Size. The width of the frame without blanking in number of cycles ⁽¹⁾ .

Notes:

1. Cycles must be always divisible by pixels per clock. For example, Cycles (Clocks) = Horizontal Resolution/ Pixels per clock.

Table 2-36: Frame Sync 0-15 Configuration Registers (Address Offsets 0x0100 - 0x013C)

0x0100	FRAME SYNC 0 CONFIG	Read/Write
Name	Bits	Description
RESERVED	31:29	Reserved
V_START	28:16	FRAME SYNCHRONIZATION VERTICAL START Vertical line during which the fsync_out[0] output port is asserted active-High. Note: Frame Syncs are not active during the complete line, only in the cycle during which both the V_START and H_START are valid each frame.
RESERVED	15:13	Reserved
H_START	12:0	FRAME SYNCHRONIZATION HORIZONTAL START Horizontal Cycle during which fsync_out[0] output port is asserted active-High

Frame Sync 1-15 Config Registers (address offset 0x0100 - 0x013c) have the same format as the Frame Sync 0 Config Register.

Table 2-37: Generator Global Delay Register (Address Offset 0x140)

0x140	Generator Global Delay	Read/Write
Name	Bits	Description
Reserved	31:29	Reserved
V_DELAY	28:16	GENERATOR VERTICAL DELAY Vertical line offset. This is the number of lines that the generated output will be shifted relative to the detector (input timing). The vertical delay is only available when both the detector and generator are enabled. Can be combined with the H_DELAY.
Reserved	15:13	Reserved
H_DELAY	12:0	GENERATOR HORIZONTAL DELAY Horizontal cycle offset. This is the number of clock cycles that the generated output will be shifted relative to the detector (input timing). The horizontal delay is only available when both the detector and generator are enabled. Can be combined with the V_DELAY.

Designing with the Core

Basic Architecture

The Video Timing Controller core contains three modules: the video timing detector, the video timing generator and the interrupt controller. See [Figure 3-1](#).

Either the detector or the generator module can be disabled at instantiation with the GUI to save resources.

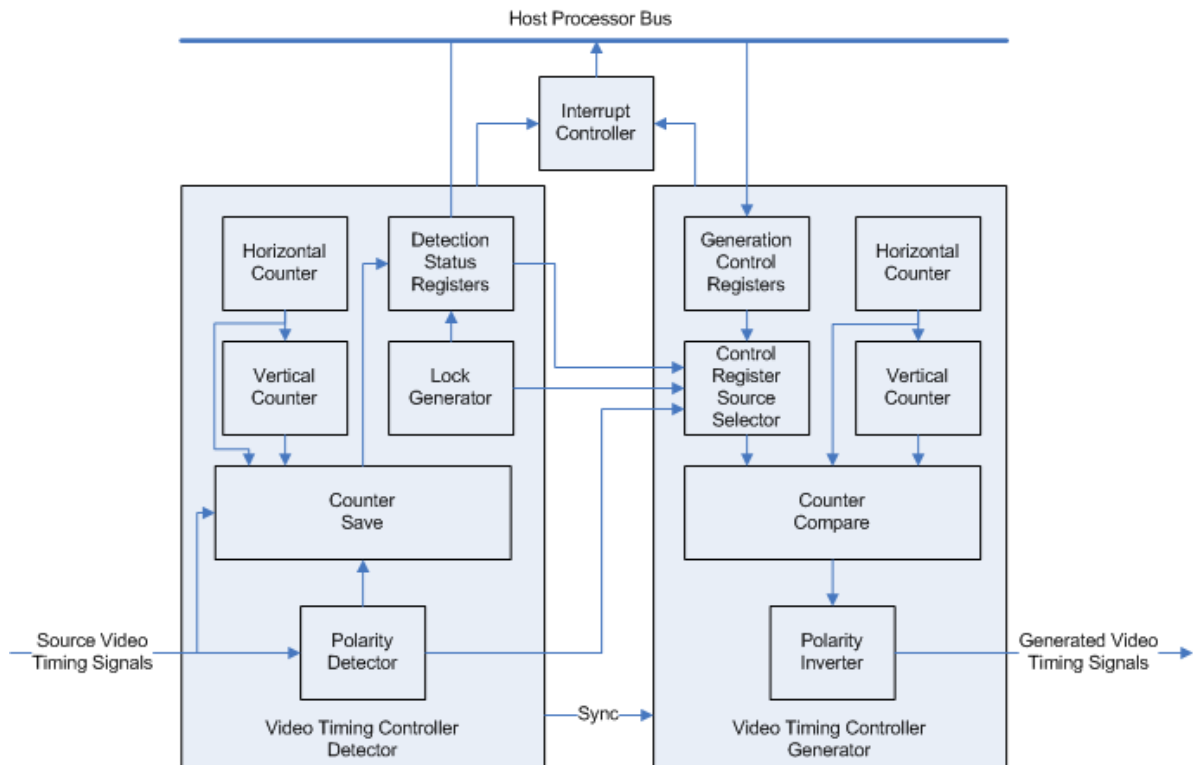

Figure 3-1: Video Timing Controller Block Diagram

Control Signals and Timing

The Video Timing Controller Inputs and Outputs are discussed and shown with timing diagrams in the following sections.

The blanking and active period definitions were discussed in [Chapter 1, Overview](#). In addition to these definitions, the period from the start of blanking (or end of active video) to the start of synchronization is called the front porch. The period from the end of synchronization to the end of blanking (or start of active video) is called the back porch. The total horizontal period (including blanking and active video) can also be defined, and similarly the total vertical period.

[Figure 3-2](#) shows the start of the horizontal front porch (Hblank Start), synchronization (Hsync Start), back porch (Hsync End) and active video (SAV). It also shows the start of the vertical front porch (Vblank Start), synchronization (Vsync Start), back porch (Vsync End) and active video (SAV). The total number of horizontal clock cycles is HSIZE and the total number of lines is the VSIZE.

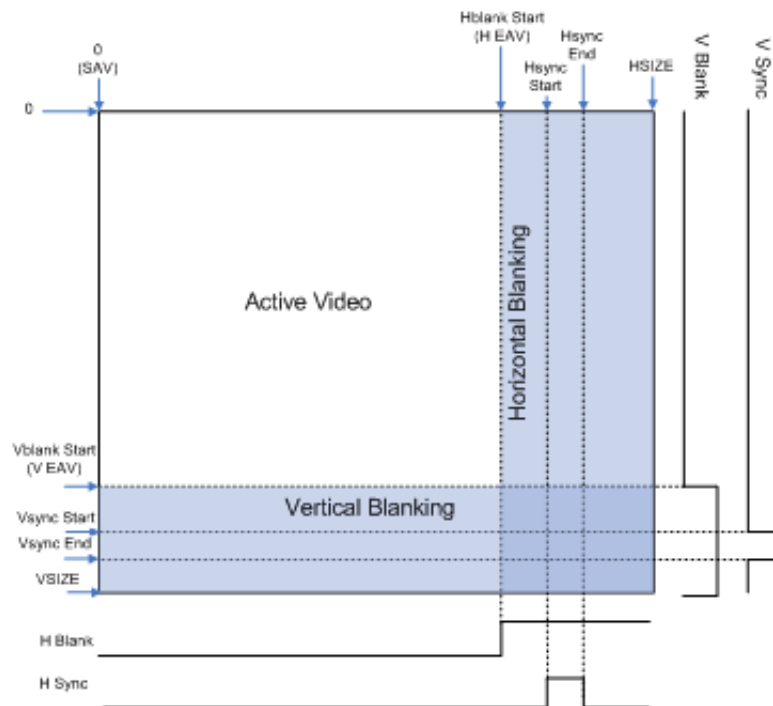

Figure 3-2: Example Video Frame and Timing Signals with Front and Back Porch

These definitions of video frame periods are used for both [Video Timing Detection](#) and [Video Timing Generation](#).



IMPORTANT: Note that pixels-per-clock for video data and timing is non-existent in the Video Timing Controller. There is only a single set of timing signals for the video data bus. This means that horizontal timing settings can be detected and generated only for a multiple of the pixels-per-clock configured in the system. For example, given a video format where the active line is 1920, the system configured with a video data bus operating at 4 pixels-per-clock, the detected and generated timing for the active line would be $(1920 \text{ pixels} / 4 \text{ pixels-per-clock}) = 480 \text{ clock (cycles)}$. Similarly, all other horizontal components (i.e. *hsync*, *hblank*) would be effected, while the vertical components do not change.

Video Timing Detection

The Video Timing Controller has six optional inputs for detecting the timing of the input video signal: vertical blank, vertical synchronization, horizontal blank, horizontal synchronization, active video and active chroma. The minimum set of inputs required to detect is either vertical blank, horizontal blank and active video or vertical sync, horizontal sync and active video. To enable detection, the *Enable Detection* GUI parameter must be set, and the control register bit 1 must also be set. The GUI parameter allows saving FPGA resources. The *Control Register* allows run-time flexibility. Other GUI parameters can be set to selectively disable detection of one or more input video timing signals.

The detected polarity of each input signal is shown by bits 0-5 of the Detection Polarity Register (address offset 0x2C). High denotes active-High polarity, and low denotes active-Low polarity. Bits 8 and 9 of the Detection Encoding Register shows the number of lines skipped between each active chroma line. Bit 8 High denotes that every other line is skipped (4:2:0), and low denotes that no lines are skipped (4:4:4 or 4:2:2). Bit 9 High denotes that every other pixel is skipped, and low denotes that no pixels are skipped.

If any input (*vblank_in*, *vsync_in*, *hblank_in*, *hsync_in*, *active_video_in*, *active_chroma_in*) is not driven or is not connected, then detection for that input must be disabled. To disable detection for an input, deselect the appropriate option in the GUI ("Vertical Blank Detection", "Vertical Sync Detection", etc.).

Video Timing Generation

The Video Timing Controller can generate up to six output video signals: vertical blank, vertical synchronization, horizontal blank, horizontal synchronization, active video and active chroma. To enable generation of these signals, the *Enable Generation* GUI parameter must be set, and the control register bit 0 or bit 2 must also be set. Other GUI parameters can be set to selectively disable generation of one or more video timing signals.

The polarity of each output signal can be set by bits 0-5 of the Generator Polarity Register (Address Offset 0x006C). High denotes active-High polarity, and low denotes active-Low polarity. Bits 8 and 9 of the Control Register also sets the number of lines skipped between each active chroma line. Bit 8 High denotes that every other line is skipped (4:2:0), and low denotes that no lines are skipped (4:4:4 or 4:2:2). Bit 9 High denotes that every other pixel is skipped, and low denotes that no pixels are skipped.

The Video Timing Controller has bits in the *Control Register* called *Source Selects* to select the internal detection registers or the external input generation registers. These bits allow the detected timing (if enabled) to control the generated outputs or allow the host processor to override each value independently via the generation registers at address offset 0x0060 - 0x0084, as described in [Table 2-3](#).

[Table 3-1](#) through [Table 3-6](#) show example settings of the input control busses and the resultant video timing output signals.

Horizontal Generation Configuration Example

Programming the horizontal generation registers to the values shown in [Table 3-1](#) will result in the video timing signal outputs shown in [Figure 3-3](#).

Notice that in [Table 3-1](#) the Control Register bit 2 is set to enable generation, that all source selects are set to 1 to select the Generation Registers and that the polarity bits are all set to 1 to configure the outputs for active-High polarity.

Table 3-1: Example Horizontal Generation Register Inputs

Register Address	Register Name	Value
0x0060	Generator Active Size	0x0003_0003
0x0070	Generator HSize	0x0000_0007
0x0078	Generator HSync	0x0005_0004
0x0068	Generator Encoding	0x0000_0000
0x006C	Generator Polarity	0x0000_003f
0x0000	Control	0x01ff_ff07

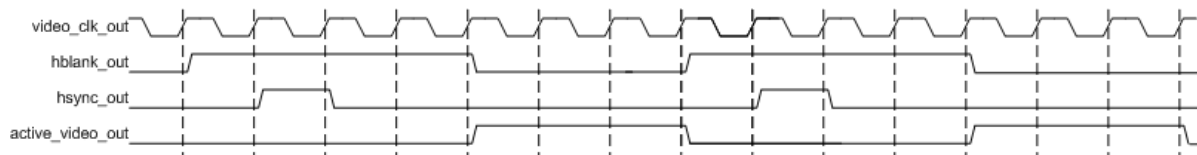

Figure 3-3: Generated Horizontal Timing



IMPORTANT: All signals are shown active-High. The polarities of the output signals can be changed at any time via the *GENERATOR POLARITY REGISTER (0x006C)*.

The following C code shows how to configure the register values in [Table 3-1](#) using the Video Timing Controller driver.

```
XVtc Vtc; /* Device driver instance */
XVtc_Signal SignalCfg; /* VTC Signal configuration */
XVtc_Polarity Polarity; /* Polarity configuration */
XVtc_SourceSelect SourceSelect; /* Source Selection configuration */
```

```

XVtc_Config *VtcCfgPtr;

VtcCfgPtr = XVtc_LookupConfig(VTC_DEVICE_ID);

XVtc_CfgInitialize(&Vtc, VtcCfgPtr, VtcCfgPtr->BaseAddress);

/* Setup the VTC Source Select config structure. */
/* 1=Generator registers are source */
/* 0=Detector registers are source */
memset((void *)&SourceSelect, 0, sizeof(SourceSelect));
SourceSelect.VBlankPolSrc      = 1;
SourceSelect.VSyncPolSrc      = 1;
SourceSelect.HBlankPolSrc     = 1;
SourceSelect.HSyncPolSrc      = 1;
SourceSelect.ActiveVideoPolSrc = 1;
SourceSelect.ActiveChromaPolSrc = 1;

SourceSelect.VChromaSrc       = 1;
SourceSelect.VActiveSrc       = 1;
SourceSelect.VBackPorchSrc    = 1;
SourceSelect.VSyncSrc        = 1;
SourceSelect.VFrontPorchSrc   = 1;
SourceSelect.VTotalSrc       = 1;
SourceSelect.HActiveSrc      = 1;
SourceSelect.HBackPorchSrc   = 1;
SourceSelect.HSyncSrc        = 1;
SourceSelect.HFrontPorchSrc  = 1;
SourceSelect.HTotalSrc       = 1;

/* Setup the VTC Polarity config structure. */
memset((void *)&Polarity, 0, sizeof(Polarity));
Polarity.ActiveChromaPol = 1;
Polarity.ActiveVideoPol  = 1;
Polarity.VBlankPol      = 1;
Polarity.VSyncPol       = 1;
Polarity.HBlankPol      = 1;
Polarity.HSyncPol       = 1;

/* Setup the VTC Signal config structure. */
memset((void *)&SignalCfg, 0, sizeof(XVtc_Signal));
SignalCfg.OriginMode      = 1; // Set Frame Origin to Start of Active Video
SignalCfg.HTotal          = 7;
SignalCfg.HActiveStart    = 0;
SignalCfg.HFrontPorchStart = 3; // Active Video Width
SignalCfg.HSyncStart      = 4; // Active Video Width + FP Width
SignalCfg.HBackPorchStart  = 5; // Active Video Width + FP Width + Sync Width

SignalCfg.V0Total         = 7;
SignalCfg.V0ChromaStart   = 0;
SignalCfg.V0ActiveStart   = 0;
SignalCfg.V0FrontPorchStart = 3; // Active Video Height
SignalCfg.V0SyncStart     = 4; // Active Video Height + FP_Width
SignalCfg.V0BackPorchStart = 5; // Active Video Height + FP Width + Sync Width

/* Write VTC config to HW */
XVtc_RegUpdate(&VTC);
XVtc_SetPolarity(&Vtc, &Polarity);
XVtc_SetGenerator(&Vtc, &SignalCfg);
XVtc_SetSource(&Vtc, &SourceSelect);
    
```

```
/* Enable VTC Generator */
XVtc_Enable Generator(&Vtc);
```

Vertical Generation Configuration Example

Programming the generation registers to the values shown in [Table 3-2](#) will result in the video timing signal outputs shown in [Figure 3-4](#).

Notice that in [Table 3-2](#) the Generator Encoding Register bits [3:0] are set to 0 to configure the number of lines skipped between each active chroma line to be 0. This configures the Active Chroma output signal for 4:4:4 or 4:2:2 mode in which every line contains valid chroma samples.

Table 3-2: Example Vertical Generation Register Inputs

Register Address	Register Name	Value
0x0060	Generator Active Size	0x0004_0003
0x0070	Generator HSize	0x0000_0007
0x0074	Generator VSize	0x0000_0008
0x0078	Generator HSync	0x0005_0004
0x0080	Generator Frame 0 Vsync	0x0006_0005
0x0068	Generator Encoding	0x0000_0000
0x006C	Generator Polarity	0x0000_003f
0x0000	Control	0x01ff_ff07

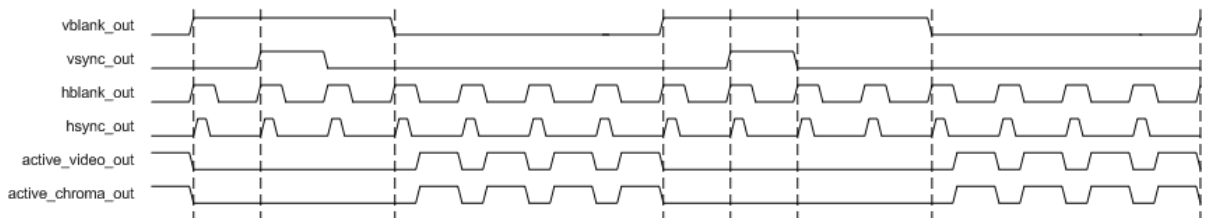

Figure 3-4: Generated Vertical Timing (4:4:4 Chroma)

The following C code shows how to configure the register values in [Table 3-2](#) using the Video Timing Controller driver.

```
XVtc Vtc; /* Device driver instance */
XVtc_Signal SignalCfg; /* VTC Signal configuration */
XVtc_Polarity Polarity; /* Polarity configuration */
XVtc_SourceSelect SourceSelect; /* Source Selection configuration */
XVtc_Config *VtcCfgPtr;

VtcCfgPtr = XVtc_LookupConfig(VTC_DEVICE_ID);
```

```

XVtc_CfgInitialize(&Vtc, VtcCfgPtr, VtcCfgPtr->BaseAddress);

/* Setup the VTC Source Select config structure. */
/* 1=Generator registers are source */
/* 0=Detector registers are source */
memset((void *)&SourceSelect, 0, sizeof(SourceSelect));
SourceSelect.VBlankPolSrc      = 1;
SourceSelect.VSyncPolSrc      = 1;
SourceSelect.HBlankPolSrc     = 1;
SourceSelect.HSyncPolSrc      = 1;
SourceSelect.ActiveVideoPolSrc = 1;
SourceSelect.ActiveChromaPolSrc = 1;

SourceSelect.VChromaSrc       = 1;
SourceSelect.VActiveSrc       = 1;
SourceSelect.VBackPorchSrc    = 1;
SourceSelect.VSyncSrc         = 1;
SourceSelect.VFrontPorchSrc   = 1;
SourceSelect.VTotalSrc        = 1;
SourceSelect.HActiveSrc       = 1;
SourceSelect.HBackPorchSrc    = 1;
SourceSelect.HSyncSrc         = 1;
SourceSelect.HFrontPorchSrc   = 1;
SourceSelect.HTotalSrc        = 1;

/* Setup the VTC Polarity config structure. */
memset((void *)&Polarity, 0, sizeof(Polarity));
Polarity.ActiveChromaPol = 1;
Polarity.ActiveVideoPol  = 1;
Polarity.VBlankPol       = 1;
Polarity.VSyncPol        = 1;
Polarity.HBlankPol       = 1;
Polarity.HSyncPol        = 1;

/* Setup the VTC Signal config structure. */
memset((void *)&SignalCfg, 0, sizeof(XVtc_Signal));
SignalCfg.OriginMode      = 1;//Set Frame Origin to Start of Active Video
SignalCfg.HTotal          = 7;
SignalCfg.HActiveStart    = 0;
SignalCfg.HFrontPorchStart = 3;// Active Video Width
SignalCfg.HSyncStart      = 4;// Active Video Width + FP Width
SignalCfg.HBackPorchStart = 5;// Active Video Width + FP Width + Sync Width

SignalCfg.V0Total         = 8;
SignalCfg.V0ChromaStart   = 0;
SignalCfg.V0ActiveStart   = 0;
SignalCfg.V0FrontPorchStart = 4;// Active Video Height
SignalCfg.V0SyncStart     = 5;// Active Video Height + FP_Width
SignalCfg.V0BackPorchStart = 6;// Active Video Height + FP Width + Sync Width

/* Write VTC config to HW */
XVtc_RegUpdate(&VTC);
XVtc_SetPolarity(&Vtc, &Polarity);
XVtc_SetGenerator(&Vtc, &SignalCfg);
XVtc_SetSource(&Vtc, &SourceSelect);

/* Enable VTC Generator */
XVtc_Enable Generator(&Vtc);
    
```

Vertical Generation Configuration Example with Active Chroma for YUV 4:2:0 Active for Even Lines

Programming the vertical generation registers to the values shown in [Table 3-3](#) will result in the video timing signal outputs shown in [Figure 3-5](#).

Notice that in [Table 3-3](#) the Generator Encoding Register bits [3:0] are set to 0b0011 to configure the number of lines skipped between each active chroma line to be one line. This configures the Active Chroma output signal for 4:2:0 mode in which only every other line contains valid chroma samples.

Table 3-3: Example Vertical Generation Register Inputs (4:2:0 Chroma)

Register Address	Register Name	Value
0x0060	Generator Active Size	0x0004_0003
0x0070	Generator HSize	0x0000_0007
0x0074	Generator VSize	0x0000_0008
0x0078	Generator HSync	0x0005_0004
0x0080	Generator Frame 0 Vsync	0x0006_0005
0x0068	Generator Encoding	0x0000_0003
0x006C	Generator Polarity	0x0000_003f
0x0000	Control	0x01ff_ff07

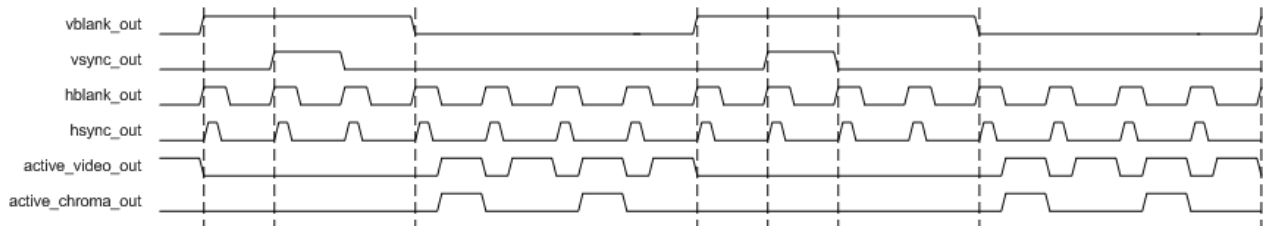

Figure 3-5: Generated Vertical Timing (4:2:0 Chroma)

The following C code shows how to configure the register values in [Table 3-3](#) using the Video Timing Controller driver.

```

XVtc Vtc; /* Device driver instance */
XVtc_Signal SignalCfg; /* VTC Signal configuration */
XVtc_Polarity Polarity; /* Polarity configuration */
XVtc_SourceSelect SourceSelect; /* Source Selection configuration */
XVtc_Config *VtcCfgPtr;

VtcCfgPtr = XVtc_LookupConfig(VTC_DEVICE_ID);

XVtc_CfgInitialize(&Vtc, VtcCfgPtr, VtcCfgPtr->BaseAddress);

/* Setup the VTC Source Select config structure. */

```

```

/* 1=Generator registers are source */
/* 0=Detector registers are source */
memset((void *)&SourceSelect, 0, sizeof(SourceSelect));
SourceSelect.VBlankPolSrc      = 1;
SourceSelect.VSyncPolSrc      = 1;
SourceSelect.HBlankPolSrc     = 1;
SourceSelect.HSyncPolSrc      = 1;
SourceSelect.ActiveVideoPolSrc = 1;
SourceSelect.ActiveChromaPolSrc = 1;

SourceSelect.VChromaSrc       = 1;
SourceSelect.VActiveSrc       = 1;
SourceSelect.VBackPorchSrc    = 1;
SourceSelect.VSyncSrc        = 1;
SourceSelect.VFrontPorchSrc   = 1;
SourceSelect.VTotalSrc        = 1;
SourceSelect.HActiveSrc       = 1;
SourceSelect.HBackPorchSrc    = 1;
SourceSelect.HSyncSrc        = 1;
SourceSelect.HFrontPorchSrc   = 1;
SourceSelect.HTotalSrc        = 1;

/* Setup the VTC Polarity config structure. */
memset((void *)&Polarity, 0, sizeof(Polarity));
Polarity.ActiveChromaPol = 1;
Polarity.ActiveVideoPol  = 1;
Polarity.VBlankPol       = 1;
Polarity.VSyncPol        = 1;
Polarity.HBlankPol       = 1;
Polarity.HSyncPol        = 1;

/* Setup the VTC Signal config structure. */
memset((void *)&SignalCfg, 0, sizeof(XVtc_Signal));
SignalCfg.OriginMode      = 1; // Set Frame Origin to Start of Active Video
SignalCfg.HTotal          = 7;
SignalCfg.HActiveStart    = 0;
SignalCfg.HFrontPorchStart = 3; // Active Video Width
SignalCfg.HSyncStart      = 4; // Active Video Width + FP Width
SignalCfg.HBackPorchStart = 5; // Active Video Width + FP Width + Sync Width

SignalCfg.V0Total         = 8;
SignalCfg.V0ChromaStart   = 0;
SignalCfg.V0ActiveStart   = 0;
SignalCfg.V0FrontPorchStart = 4; // Active Video Height
SignalCfg.V0SyncStart     = 5; // Active Video Height + FP_Width
SignalCfg.V0BackPorchStart = 6; // Active Video Height + FP Width + Sync Width

/* Write VTC config to HW */
XVtc_RegUpdate(&VTC);
XVtc_SetPolarity(&Vtc, &Polarity);
XVtc_SetGenerator(&Vtc, &SignalCfg);
XVtc_SetSource(&Vtc, &SourceSelect);
XVtc_SetSkipLine(&Vtc, 1);

/* Enable VTC Generator */
XVtc_Enable Generator(&Vtc)

```

Vertical Generation Configuration Example with Active Chroma for YUV 4:2:0 Active for Odd Lines

Programming the vertical generation registers to the values shown in [Table 3-4](#) will result in the video timing signal outputs shown in [Figure 3-6](#).

Notice that the Generator Encoding Register bits [3:0] are set to 0b0011, as in the previous example. Bits [9:8] of the Generator Encoding Register is set to 1 instead of 0. This configures the Active Chroma output signal for 4:2:0 mode, but with the opposite line set.

Table 3-4: Example Vertical Generation Register Inputs (Alternate 4:2:0 Chroma)

Register Address	Register Name	Value
0x0060	Generator Active Size	0x0004_0003
0x0070	Generator HSize	0x0000_0007
0x0074	Generator VSize	0x0000_0008
0x0078	Generator HSync	0x0005_0004
0x0080	Generator Frame 0 Vsync	0x0006_0005
0x0068	Generator Encoding	0x0000_0103
0x006C	Generator Polarity	0x0000_003f
0x0000	Control	0x01ff_ff07

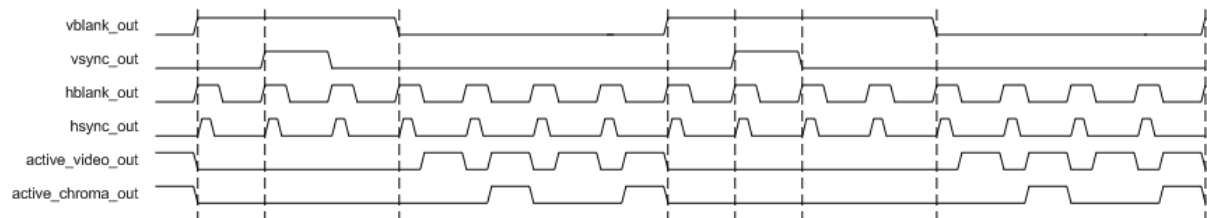

Figure 3-6: Generated Vertical Timing (Alternate 4:2:0 Chroma)

The following C code shows how to configure the register values in [Table 3-4](#) using the Video Timing Controller driver.

```

XVtc Vtc; /* Device driver instance */
XVtc_Signal SignalCfg; /* VTC Signal configuration */
XVtc_Polarity Polarity; /* Polarity configuration */
XVtc_SourceSelect SourceSelect; /* Source Selection configuration */
XVtc_Config *VtcCfgPtr;

VtcCfgPtr = XVtc_LookupConfig(VTC_DEVICE_ID);

XVtc_CfgInitialize(&Vtc, VtcCfgPtr, VtcCfgPtr->BaseAddress);

/* Setup the VTC Source Select config structure. */
/* 1=Generator registers are source */
/* 0=Detector registers are source */

```



```

memset((void *)&SourceSelect, 0, sizeof(SourceSelect));
SourceSelect.VBlankPolSrc      = 1;
SourceSelect.VSyncPolSrc      = 1;
SourceSelect.HBlankPolSrc     = 1;
SourceSelect.HSyncPolSrc      = 1;
SourceSelect.ActiveVideoPolSrc = 1;
SourceSelect.ActiveChromaPolSrc = 1;

SourceSelect.VChromaSrc       = 1;
SourceSelect.VActiveSrc       = 1;
SourceSelect.VBackPorchSrc    = 1;
SourceSelect.VSyncSrc         = 1;
SourceSelect.VFrontPorchSrc   = 1;
SourceSelect.VTotalSrc        = 1;
SourceSelect.HActiveSrc       = 1;
SourceSelect.HBackPorchSrc    = 1;
SourceSelect.HSyncSrc         = 1;
SourceSelect.HFrontPorchSrc   = 1;
SourceSelect.HTotalSrc        = 1;

/* Setup the VTC Polarity config structure. */
memset((void *)&Polarity, 0, sizeof(Polarity));
Polarity.ActiveChromaPol = 1;
Polarity.ActiveVideoPol  = 1;
Polarity.VBlankPol       = 1;
Polarity.VSyncPol        = 1;
Polarity.HBlankPol       = 1;
Polarity.HSyncPol        = 1;

/* Setup the VTC Signal config structure. */
memset((void *)&SignalCfg, 0, sizeof(XVtc_Signal));
SignalCfg.OriginMode      = 1;//Set Frame Origin to Start of Active Video
SignalCfg.HTotal          = 7;
SignalCfg.HActiveStart    = 0;
SignalCfg.HFrontPorchStart = 3;// Active Video Width
SignalCfg.HSyncStart      = 4;// Active Video Width + FP Width
SignalCfg.HBackPorchStart = 5;// Active Video Width + FP Width + Sync Width

SignalCfg.V0Total         = 8;
SignalCfg.V0ChromaStart   = 0;
SignalCfg.V0ActiveStart   = 1;
SignalCfg.V0FrontPorchStart = 4;// Active Video Height
SignalCfg.V0SyncStart     = 5;// Active Video Height + FP_Width
SignalCfg.V0BackPorchStart = 6;// Active Video Height + FP Width + Sync Width

/* Write VTC config to HW */
XVtc_RegUpdate(&VTC);
XVtc_SetPolarity(&Vtc, &Polarity);
XVtc_SetGenerator(&Vtc, &SignalCfg);
XVtc_SetSource(&Vtc, &SourceSelect);
XVtc_SetSkipLine(&Vtc, 1);

/* Enable VTC Generator */
XVtc_Enable Generator(&Vtc);
    
```

Timing Regeneration Example with Selective Signals Overridden

Table 3-5 shows the detection register values for the source video timing in Figure 3-7. Programming the horizontal generation registers to the values shown in Table 3-6 will result in the video timing signal outputs shown in Figure 3-7.

Table 3-5: Example Horizontal Detection Register Outputs

Register Address	Register Name	Value
0x0020	Detector Active Size	0x0004_0003
0x0030	Detector HSize	0x0000_0007
0x0038	Detector HSync	0x0005_0004
0x0028	Detector Encoding	0x0000_0000
0x002C	Detector Polarity	0x0000_003f

Notice that all polarities bits are High in the Detection Polarity Register, signifying that all inputs are detected to have an active-High polarity.

Table 3-6: Example Horizontal Generation Register Inputs

Register Address Example Horizontal Generation Register Inputs	Register Name	Value
0x0060	Generator Active Size	0x0004_0001
0x0070	Generator HSize	0x0000_0007
0x0078	Generator HSync	0x0004_0003
0x0068	Generator Encoding	0x0000_0000
0x006C	Generator Polarity	0x0000_0037
0x0000	Control	0x0080_062f

Notice, in the Control Register, that bit 2 is set to enable generation, bit 3 is set to enable detection and bit 5 is set to enable synchronizing the generated output to the detected inputs.

The Horizontal Size (`ACTIVE_HSIZE_SRC`) Source Select (bit 9 of the Control Register) is set to 1. All other source selects are low, signifying that all other detection registers should be used.

Also notice that the polarity of the output horizontal synchronization has been changed to active-Low by clearing bit 3 of the Generator Polarity Register.

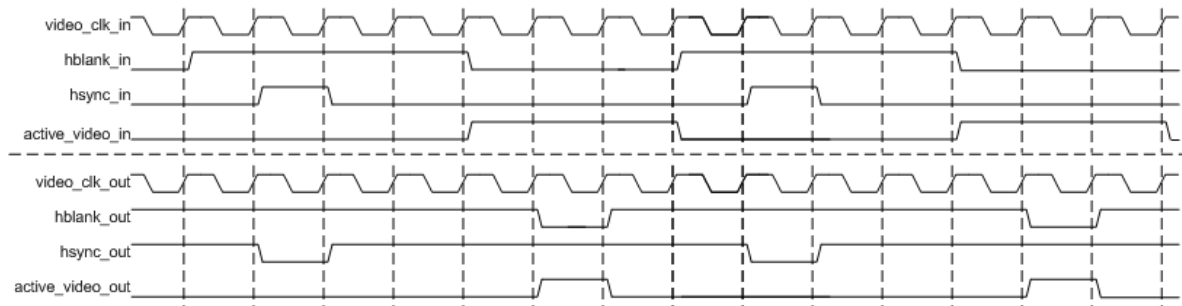

Figure 3-7: Detected and Regenerated Horizontal Timing



IMPORTANT: All generated outputs remain synchronized to the inputs. The only changes made to the output are to the horizontal synchronization polarity and to the active video start and stop times.

The following C code shows how to configure the register values in [Table 3-6](#) using the Video Timing Controller driver.

```

XVtc Vtc; /* Device driver instance */
XVtc_Signal SignalCfg; /* VTC Signal configuration */
XVtc_Polarity Polarity; /* Polarity configuration */
XVtc_SourceSelect SourceSelect; /* Source Selection configuration */
XVtc_Config *VtcCfgPtr;

VtcCfgPtr = XVtc_LookupConfig(VTC_DEVICE_ID);

XVtc_CfgInitialize(&Vtc, VtcCfgPtr, VtcCfgPtr->BaseAddress);

/* Setup the VTC Source Select config structure. */
/* 1=Generator registers are source */
/* 0=Detector registers are source */
memset((void *)&SourceSelect, 0, sizeof(SourceSelect));
SourceSelect.VBlankPolSrc = 0;
SourceSelect.VSyncPolSrc = 0;
SourceSelect.HBlankPolSrc = 0;
SourceSelect.HSyncPolSrc = 1;
SourceSelect.ActiveVideoPolSrc = 0;
SourceSelect.ActiveChromaPolSrc = 0;

SourceSelect.VChromaSrc = 0;
SourceSelect.VActiveSrc = 1;
SourceSelect.VBackPorchSrc = 0;
SourceSelect.VSyncSrc = 0;
SourceSelect.VFrontPorchSrc = 0;
SourceSelect.VTotalSrc = 0;
SourceSelect.HActiveSrc = 0;
SourceSelect.HBackPorchSrc = 0;
SourceSelect.HSyncSrc = 0;
SourceSelect.HFrontPorchSrc = 0;
SourceSelect.HTotalSrc = 0;
    
```

```

/* Setup the VTC Polarity config structure. */
memset((void *)&Polarity, 0, sizeof(Polarity));
Polarity.ActiveChromaPol = 1;
Polarity.ActiveVideoPol = 1;
Polarity.VBlankPol = 1;
Polarity.VSyncPol = 1;
Polarity.HBlankPol = 1;
Polarity.HSyncPol = 0;

/* Setup the VTC Signal config structure. */
memset((void *)&SignalCfg, 0, sizeof(XVtc_Signal));
SignalCfg.OriginMode = 1;//Set Frame Origin to Start of Active Video
SignalCfg.HTotal = 7;
SignalCfg.HActiveStart = 0;
SignalCfg.HFrontPorchStart = 1;// Active Video Width
SignalCfg.HSyncStart = 3;// Active Video Width + FP Width
SignalCfg.HBackPorchStart = 4;// Active Video Width + FP Width + Sync Width

SignalCfg.V0Total = 8;
SignalCfg.V0ChromaStart = 0;
SignalCfg.V0ActiveStart = 0;
SignalCfg.V0FrontPorchStart = 4;// Active Video Height
SignalCfg.V0SyncStart = 5;// Active Video Height + FP_Width
SignalCfg.V0BackPorchStart = 6;// Active Video Height + FP Width + Sync Width

/* Write VTC config to HW */
XVtc_RegUpdate(&VTC);
XVtc_SetPolarity(&Vtc, &Polarity);
XVtc_SetGenerator(&Vtc, &SignalCfg);
XVtc_SetSource(&Vtc, &SourceSelect);
XVtc_EnableSync(&Vtc);// Synchronize the Generator to the Detector

/* Enable VTC Generator and Detector*/
XVtc_Enable(&Vtc);

```

Synchronization

Generation of the video timing output signals can be synchronized to the detected video timing input signals or generated independently by setting the `SYNC_ENABLE` field in the control register or selecting the GUI option to synchronize the generator to detector or `fsync_in`. Synchronization allows the generator to follow the phase of the detector timing. Synchronization of the output to the input allows the developer to override each individual timing signal with different settings such as signal polarity or start time. For example, the active video signal could be regenerated shifted one cycle earlier or later. This provides a flexible method for regenerating video timing output signals with different settings while remaining synchronized to the input timing.

The Video Timing Controller also has a GUI parameter, called Auto Generation Mode, to control the behavior of the generated outputs based on the detected inputs. When the Auto Generation Mode parameter is set, the generated video timing outputs will change based on the detected inputs. If this parameter is not set, then the video timing outputs will be generated based on only the first detected input format. (If the detector loses lock, the generated outputs will continue to be generated.) To change output timing while Auto

Generation Mode is set, timing detection must first be disabled by clearing bit 1 in the Control Register and then re-enabling, if any of the Source Select bits are low.

Frame Syncs

The Video Timing Controller has a frame synchronization output bus. Each bit can be configured to toggle high for any one clock cycle during each video frame. Each bit is independently configured for horizontal and vertical clock cycle position with the Frame Sync Configuration Registers (address offsets 0x0100 - 0x013c).

Interrupts

The Video Timing Controller has an active-High interrupt output port named "irq". This output is set high when an interrupt occurs and set low when the interrupt event has been cleared. The Video Timing Controller also contains three 32-bit registers for configuring and reporting status of interrupts: the Interrupt Status/Clear, the Interrupt Enable and the Interrupt Clear Registers. A logical AND is performed on the Interrupt Enable Register and the Interrupt Status Register to set the interrupt output high. The Interrupt Clear Register is used to clear the Interrupt Status Register. Writing a '1' to a bit in the Interrupt Status Register clears the corresponding interrupt when set. Writing a '1' to a bit that is cleared, will have no effect.

Use Model

This section illustrates likely usage scenarios for the Xilinx® Video Timing Controller core.

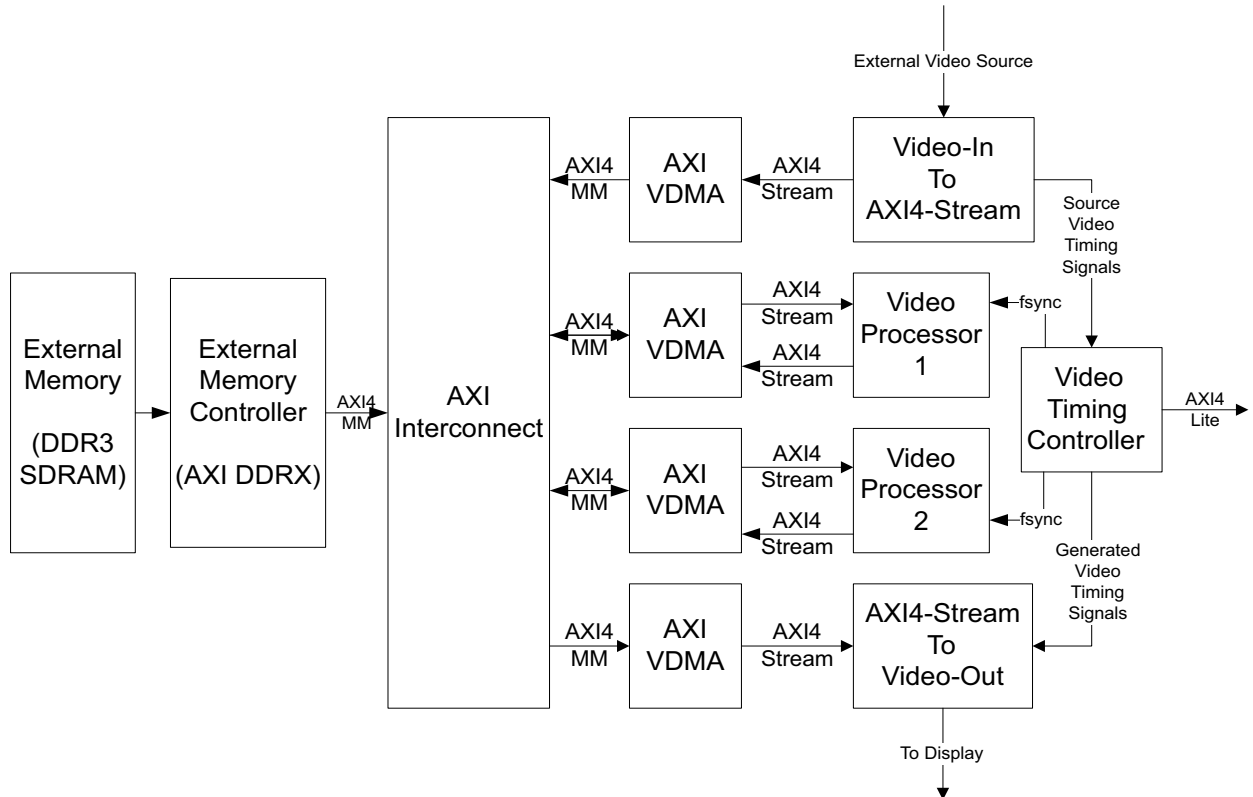

Figure 3-8: Example Video Timing Controller Use Model

Figure 3-8 shows four features of the Video Timing Controller being utilized in a video system:

- Detection of the source video frame timing
- Generation of video timing signals
- Generation of two Frame Syncs to control the Video Processors
- Connection to a Host Processor via the AXI4-Lite interface

To detect the timing of the source video, the timing signals are connected to the Video Timing Controller Detection Module. Both the timing and the signal polarity of the timing signals are captured and easily read by the host processor.

Video timing signals are generated to control a AXI4-Stream to Video-Out module and an external display. The timing of these output signals is controlled by the host processor. The Video Timing Controller can be configured in real-time to replicate the source video format or to slightly change the format on the output, for example, in cases where the input signals are positive polarity yet the display requires negative polarity synchronization signals. The Video Timing Controller can also be reconfigured in real-time to output a completely different format from the input source.

Two Frame Sync outputs are generated to control Video Processor 1 and Video Processor 2. These outputs could be used to control when Video Processor 2 starts processing relative to

when Video Processor 1 starts processing. These Frame Syncs can be reconfigured in real-time as well.

The Video Timing Controller is connected to a Host Processor in this example. The AXI4-Lite Interface allows for easy connection between status/control registers and the host processor. In addition, the Video Timing Controller interrupt output can also be used to synchronize the software with hardware events.

If the video system requires that only complete video frames are sent from the Video-In To AXI4-Stream core, then the Video Timing Controller must be configured to drive the axis_enable input with bit 8 of the INTC_IF bus. This bus must be enabled with the "Include INTC Interface".

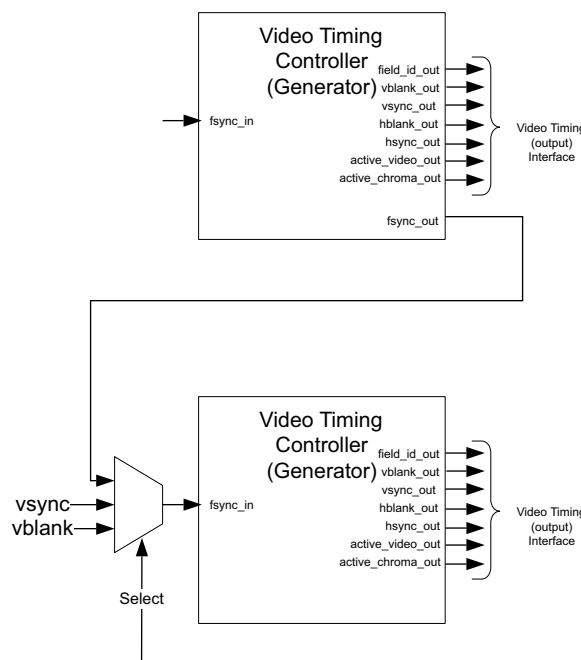

Figure 3-9: Video Timing Controller Generator Synchronization Use Model

Figure 3-9 shows the ability of the Video Timing Controller to synchronize the timing generator to an incoming frame sync, vertical sync or vertical blank signal. This is useful to generate timing signals that are not present. For example, if blank signals can be generated from sync signals. Also, this allows the timing generator to synchronize to a separate timing generator

In this example, the bottom timing generator can be synchronized to the top timing controller, a separate vsync or separate vblank signal. This is controlled by the mux "Select" signal.



IMPORTANT: The timing generator can be offset from the input by configuring the Generator Global Delay Register (Address Offset 0x140)].

Once the `fsync_in` input is selected, the pixel or line offset delay of the synchronized generator can be configured with the Generator Global Delay Register.

Clocking

The Video Timing Controller core has two clock sources, `CLK` and `S_AXI_ACLK`, one for each clock domain. The Video Timing Controller core also has four clock enable sources: `CLK`, `DET_CLKEN`, `GEN_CLKEN` and `S_AXI_ACLKEN`.

CLK

The input and output video timing interfaces use the `CLK` clock signal as their shared clock reference.

S_AXI_ACLK

The AXI4-Lite interface uses the `S_AXI_ACLK` pin as its clock source. The `CLK` pin is not shared between the AXI4-Lite and video timing interfaces. The Video Timing Controller core contains clock-domain crossing logic between the `CLK` (video timing) and `S_AXI_ACLK` (AXI4-Lite) clock domains. The core automatically ensures that the AXI4-Lite transactions completes even if the video processing is stalled with `RESETn`, `CLKEN` or with the video clock not running.

CLKEN

The Video Timing Controller core has multiple enable options: the `CLKEN` pin (hardware clock enable), and the software enable option provided via the AXI4-Lite control interface (when present).

The `CLKEN` pin cannot ensure synchronization internally to video timing processing therefore de-asserting `CLKEN` for extended periods of time may lead to generating incomplete frames or lengthening the period needed to detect incoming video frame timing.

The `CLKEN` pin facilitates:

- Multi-cycle path designs (high speed clock division without clock gating),
- Standby operation of subsystems to save on power
- Hardware controlled bring-up of system components

DET_CLKEN

The Video Timing Controller core also has a separate clock enable input pin to control the detector. This clock enable allows halting the detector independently from the generator.

GEN_CLKEN

The Video Timing Controller core also has a separate clock enable input pin to control the generator. This clock enable allows halting the generator independently from the detector.

S_AXI_ACLKEN

The S_AXI_ACLKEN is the clock enable signal for the AXI4-Lite interface only. Driving this signal low only affects the AXI4-Lite interface and does not halt the video timing processing in the CLK clock domain.

Resets

The Video Timing Controller core has two reset pins, `RESETn` and `S_AXI_ARESETn`, one for each clock domain. Both resets are active-Low.

RESETn

The Video Timing Controller core has two reset sources: the `RESETn` pin (hardware reset), and the software reset provided via the AXI4-Lite control interface (when present). The software reset is available via the control register at address offset 0x0000, bit 31.

IMPORTANT: *RESETn is not synchronized internally to the video timing processing. De-asserting RESETn while frame timing is being process can lead to incomplete frames (from the generator).*

The external reset pulse needs to be held for at least 32 CLK cycles to reset the core. The `RESETn` signal only resets the video timing interfaces and processing of the core. The AXI4-Lite interface is unaffected by the `RESETn` signal to allow the video timing processing core to be reset without halting the AXI4-Lite interface. However, if the `RESETn` is asserted low during an AXI4-Lite register read or write, the AXI4-Lite interface asserts the slave error response (0x2) for all addresses.



IMPORTANT: *When a system with multiple-clocks and corresponding reset signals are being reset, the reset generator has to ensure all signals are asserted/de-asserted long enough so that all interfaces and clock-domains are correctly reinitialized.*

S_AXI_ARESETn

The S_AXI_ARESETn signal is synchronous to the S_AXI_ACLK clock domain, but is internally synchronized to the CLK clock domain. The S_AXI_ARESETn signal resets the entire core including the AXI4-Lite and video timing interfaces.

Protocol Description

The Video Timing Controller core register interface is compliant with the AXI4-Lite interface.

Customizing and Generating the Core

This chapter includes information about using Xilinx tools to customize and generate the core in the Vivado[®] Design Suite environment.

Vivado Integrated Design Environment (IDE)

You can customize the IP for use in your design by specifying values for the various parameters associated with the IP core using the following steps:

1. Select the IP from the IP catalog.
2. Double-click on the selected IP or select the Customize IP command from the toolbar or popup menu.

For details, see the sections, “Working with IP” and “Customizing IP for the Design” in the *Vivado Design Suite User Guide: Designing with IP* (UG896) [Ref 3] and the “Working with the Vivado IDE” section in the *Vivado Design Suite User Guide: Getting Started* (UG910) [Ref 5].

If you are customizing and generating the core in the Vivado IP Integrator, see the *Vivado Design Suite User Guide: Designing IP Subsystems Using IP Integrator* (UG994) [Ref 7] for detailed information. IP Integrator might auto-compute certain configuration values when validating or generating the design. To check whether the values do change, see the description of the parameter in this chapter. To view the parameter value you can run the `validate_bd_design` command in the Tcl console.

Note: Figures in this chapter are illustrations of the Vivado IDE. This layout might vary from the current version.

Graphical User Interface

The Xilinx® Video Timing Controller core is easily configured to meet the developer's specific needs through the Vivado® tools graphical user interface (Figure 4-1, Figure 4-2). This section provides a quick reference to parameters that can be configured at generation time.

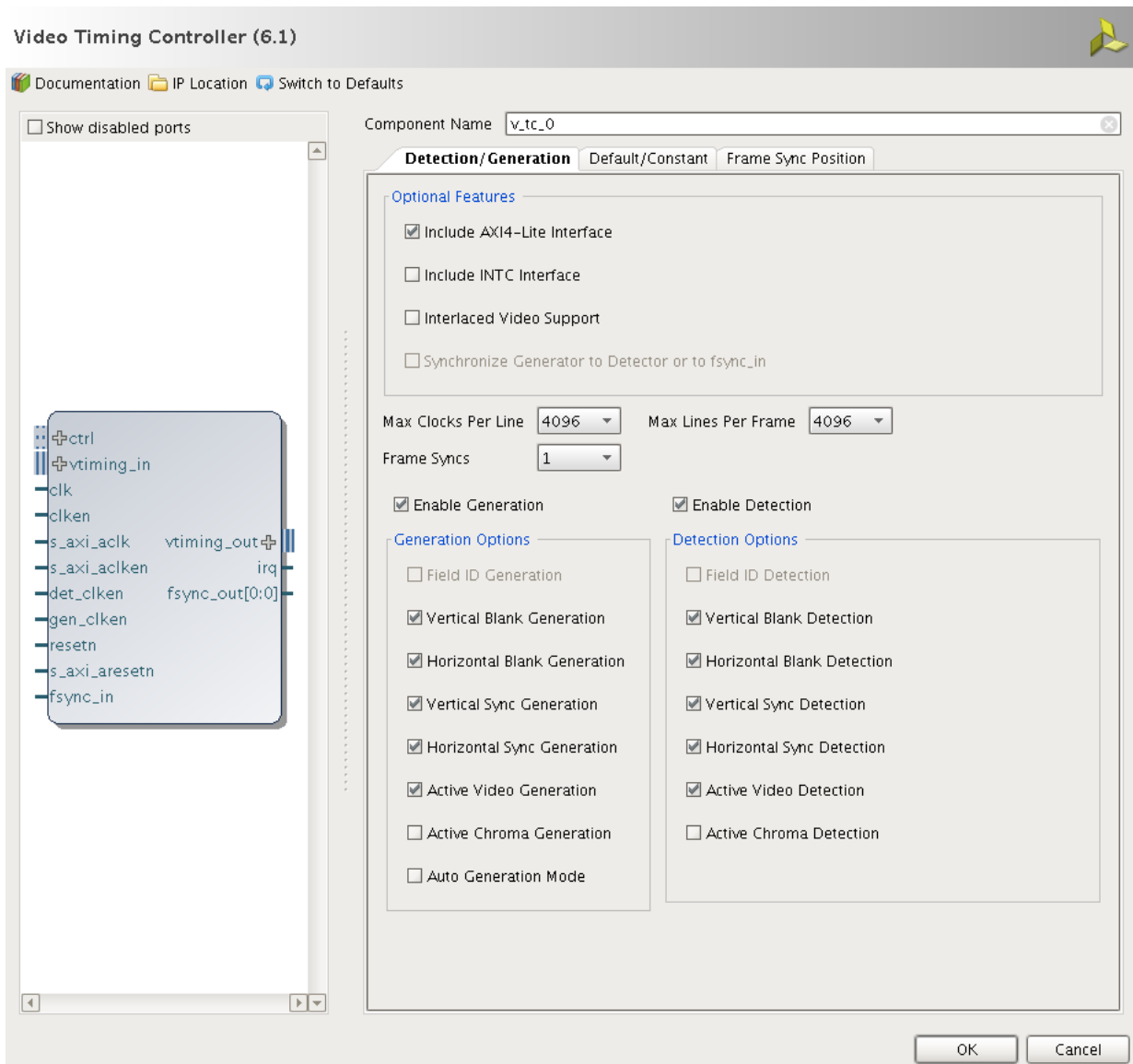

Figure 4-1: Vivado IP Catalog GUI - Main Window

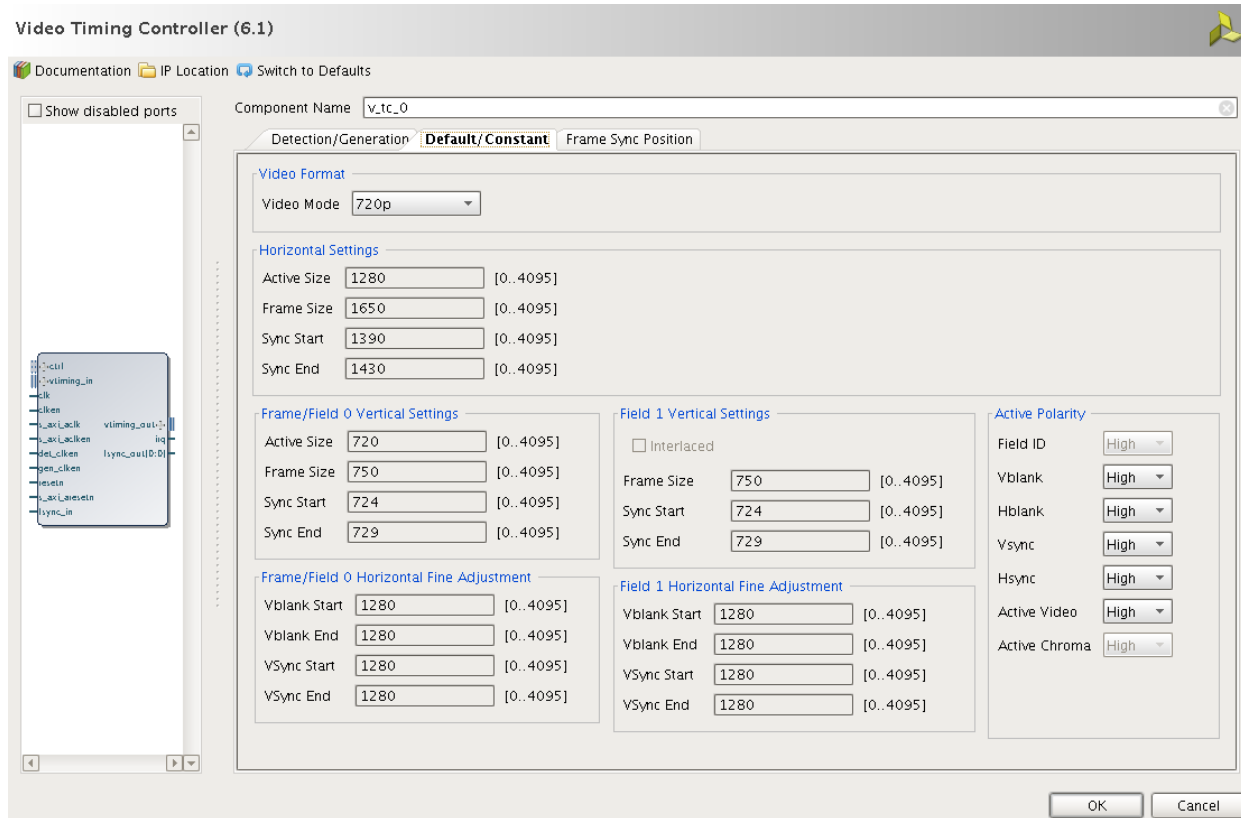

Figure 4-2: Vivado IP Catalog GUI - Default/Constant Mode Options Tab

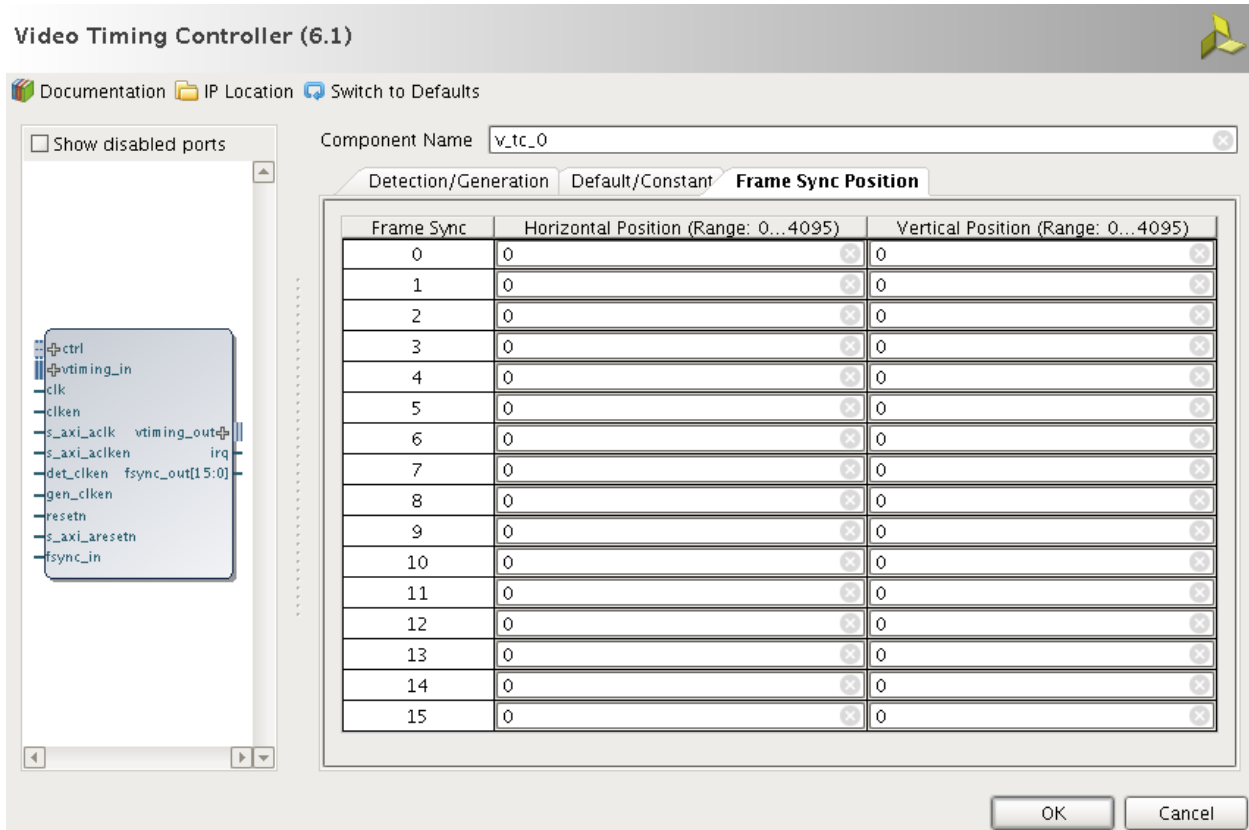

Figure 4-3: Vivado IP GUI - Frame Sync Position Tab

The GUI displays a representation of the IP symbol on the left side and the parameter assignments on the right side, described as follows:

- **Component Name:** The component name is used as the base name of output files generated for the module. Names must begin with a letter and must be composed from characters: a to z, 0 to 9 and "_".
 - Note:** The name `v_tc_v6_1` is not allowed.
- **Optional Features:**
 - **Include AXI4-Lite Interface:** When selected, the core is generated with an AXI4-Lite interface, which gives access to dynamically program and change processing parameters. For more information, refer to Chapter 2, Core Interfaces.
 - **Include INTC Interface:** When selected, the core generates the optional INTC_IF port, which gives parallel access to signals indicating frame processing status and error conditions. For more information, refer to Interrupts in Chapter 2.
 - **Interlaced Video Support:** When selected, the core is generated with interlaced video detection and/or generation enabled.
 - **Synchronize Generator to Detector or to fsync_in:** When selected, the timing generator automatically synchronizes to the detector or to the `fsync_in` input port. Otherwise, the generator runs in free-run mode.

- **Options:**
 - **Maximum Clocks per Line:** This parameter sets the maximum number of clock cycles per video line that the Video Timing Controller can generate or detect. Values of 128, 256, 512, 1024, 2048, 4096 and 8192 are valid.
 - **Maximum Lines per Frame:** This parameter sets the maximum number of lines per video frame that the Video Timing Controller can generate or detect. Values of 128, 256, 512, 1024, 2048, 4096 and 8192 are valid.
 - **Frame Syncs:** This parameter sets the number of frame synchronization outputs to generate and supports up to 16 independent outputs.
 - **Enable Generation:** This parameter enables or disables the video timing outputs.
 - **Enable Detection:** This parameter enables or disables the detecting the timing of the video inputs.
 - **Generation Options:**
 - **Field ID Generation:** This parameter enables or disables generating the field ID output.
 - **Vertical Blank Generation:** This parameter enables or disables generating the vertical blank output.
 - **Horizontal Blank Generation:** This parameter enables or disables generating the horizontal blank output.
 - **Vertical Sync Generation:** This parameter enables or disables generating the vertical synchronization output.
 - **Horizontal Sync Generation:** This parameter enables or disables generating the horizontal synchronization output.
 - **Active Video Generation:** This parameter enables or disables generating the active video output.
 - **Active Chroma Generation:** This parameter enables or disables generating the active chroma output.
 - **Auto Generation Mode:** When enabled, this parameter will cause the generated video timing outputs to change based on the detected inputs. If this parameter is disabled, the video timing outputs will be generated based on only the first detected input format. The output for the generated synchronization signals will continue even if the detection block loses lock. This parameter is available only if both the **Enable Generation** and **Enable Detection** parameters are enabled. Note: This parameter has an effect only if one or more of the source select control register bits are set to low.
 - **Detection Options:**
 - **Field ID Detection:** This parameter enables or disables detecting the field id input.

- **Vertical Blank Detection:** This parameter enables or disables detecting the vertical blank input. If the `vblank_in` input will not be connected, then the **Vertical Blank Detection** option must be deselected.
- **Horizontal Blank Detection:** This parameter enables or disables detecting the horizontal blank input. If the `hblank_in` input will not be connected, then the **Horizontal Blank Detection** option must be deselected.
- **Vertical Sync Detection:** This parameter enables or disables detecting the vertical synchronization input. If the `vsync_in` input will not be connected, then the **Vertical Sync Detection** option must be deselected.
- **Horizontal Sync Detection:** This parameter enables or disables detecting the horizontal synchronization input. If the `hsync_in` input will not be connected, then the **Horizontal Sync Detection** option must be deselected.
- **Active Video Detection:** This parameter enables or disables detecting the active video input. If the `active_video_in` input will not be connected, then the **Active Video Detection** option must be deselected.
- **Active Chroma Detection:** This parameter enables or disables detecting the active chroma input. If the `active_chroma_in` input will not be connected, then the **Active Chroma Detection** option must be deselected.
- **Constant/Default Timing Generation Options:**
 - **Video Format:**
 - **Video Mode:** This parameter sets the default video format and controls the Horizontal, Vertical and Horizontal Fine Adjustment settings below. Values of 720p, 480p, 576p, 1080p, 352x288p, 352x576p, 480x576p, 544x575p, 704x576p, 704x480p, 640x480p, 800x600p, 1024x768p, 1280x1024p, 1600x1200p or Custom are valid. The interlaced video modes of 1080i, 480i and 576i are also available when the **Interlaced Support** parameter is checked. Video Modes are removed or added to this list based upon the sizes selected in the **Max Clocks per Line** and **Max Lines per Frame** parameters.
 - **Chroma Format:** This parameter sets the default value of the video format in the `GENERATOR_ENCODING` register at address offset 0x68. This controls the behavior of the `active_chroma_out` output port.
 - **Chroma Parity:** This parameter sets the default value of the chroma parity in the `GENERATOR_ENCODING` register at address offset 0x68. This controls the behavior of the `active_chroma_out` output port.
 - **Horizontal Settings:**
 - **Active Size:** This parameter sets the default number of clock cycles per frame (without blanking) in the `GENERATOR_ACTIVE_SIZE` register at address offset 0x060.
 - **Frame Size:** This parameter sets the default number of clock cycles per frame (with blanking) in the `GENERATOR_HSIZE` register at address offset 0x70.

- **Sync Start:** This parameter sets the default value of the clock cycle count during which the horizontal sync starts in the `GENERATOR_HSYNC` register at address offset 0x78.
- **Sync End:** This parameter sets the default value of the clock cycle count during which the horizontal sync ends in the `GENERATOR_HSYNC` register at address offset 0x78.
- o **Frame/Field 0 Vertical Settings:**
 - **Active Size:** This parameter sets the default number of lines per frame (without blanking) in the `GENERATOR_ACTIVE_SIZE` register at address offset 0x060.
 - **Frame Size:** This parameter sets the frame/field 0 default number of lines per frame size (with blanking) in the `GENERATOR_VSIZE` register at address offset 0x74, bits 12:0.
 - **Sync Start:** This parameter sets the default value of the line count during which the vertical sync starts in the `GENERATOR_F0_VSYNC_V` register at address offset 0x80.
 - **Sync End:** This parameter sets the default value of the line count during which the vertical sync ends in the `GENERATOR_F0_VSYNC_V` register at address offset 0x80.
- o **Frame/Field 0 Horizontal Fine Adjustment:**
 - **Vblank Start:** This parameter sets the default value of the clock cycle count during which the vertical blank starts in the `GENERATOR_F0_VBLANK_H` register at address offset 0x7C.
 - **Vblank End:** This parameter sets the default value of the clock cycle count during which the vertical blank ends in the `GENERATOR_F0_VBLANK_H` register at address offset 0x7C.
 - **Vsync Start:** This parameter sets the default value of the clock cycle count during which the vertical sync starts in the `GENERATOR_F0_VSYNC_H` register at address offset 0x84.
 - **Vsync End:** This parameter sets the default value of the clock cycle count during which the vertical sync ends in the `GENERATOR_F0_VSYNC_H` register at address offset 0x84.
- o **Field 1 Vertical Settings:**
 - **Interlaced:** This parameter enables generating interlaced video and sets the Interlaced bit (6) in the `GENERATOR_ENCODING` register to 1. This parameter is only available when the **Interlaced Video Support** parameter is enabled.
 - **Frame Size:** This parameter sets the Field 1 default number of lines per frame size (with blanking) in the `GENERATOR_VSIZE` register at address offset 0x74, bits 28:16.

- **Sync Start:** This parameter sets the Field 1 default value of the line count during which the vertical sync starts in the `GENERATOR_F1_VSYNC_V` register at address offset 0x8C.
- **Sync End:** This parameter sets the Field 1 default value of the line count during which the vertical sync ends in the `GENERATOR_F1_VSYNC_V` register at address offset 0x8C.
- **Field 1 Horizontal Fine Adjustment:**
 - **Vblank Start:** This parameter sets the Field 1 default value of the clock cycle count during which the vertical blank starts in the `GENERATOR_F1_VBLANK_H` register at address offset 0x88.
 - **Vblank End:** This parameter sets the Field 1 default value of the clock cycle count during which the vertical blank ends in the `GENERATOR_F1_VBLANK_H` register at address offset 0x88.
 - **VSync Start:** This parameter sets the Field 1 default value of the clock cycle count during which the vertical sync starts in the `GENERATOR_F1_VSYNC_H` register at address offset 0x90.
 - **VSync End:** This parameter sets the Field 1 default value of the clock cycle count during which the vertical sync ends in the `GENERATOR_F1_VSYNC_H` register at address offset 0x90.
- **Active Polarity:**
 - **Field ID:** This parameter sets the polarity of the `field_id_out` signal. Values of **Active High** or **Active Low** are valid. This parameter is enabled when the **Interlaced Video Support** and **Interlaced** parameters are enabled.
 - **Vblank:** This parameter sets the polarity of the `vblank_out` signal. Values of **Active High** or **Active Low** are valid.
 - **Hblank:** This parameter sets the polarity of the `hblank_out` signal. Values of **Active High** or **Active Low** are valid.
 - **VSync:** This parameter sets the polarity of the `vsync_out` signal. Values of **Active High** or **Active Low** are valid.
 - **HSync:** This parameter sets the polarity of the `hsync_out` signal. Values of **Active High** or **Active Low** are valid.
 - **Active Video:** This parameter sets the polarity of the `active_video_out` signal. Values of **Active High** or **Active Low** are valid.
 - **Active Chroma:** This parameter sets the polarity of the `active_chroma_out` signal. Values of **Active High** or **Active Low** are valid.
- **Frame Sync Position:**

- **Frame Sync # Horizontal Position:** These parameters set the default value of the clock cycle count during which Frame Sync # is active in the FRAME_SYNC 0-15 CONFIG registers at address offset 0x100-0x13c.
- **Frame Sync # Vertical Position:** These parameters set the default value of the line count during which Frame Sync # is active in the FRAME_SYNC 0-15 CONFIG registers at address offset 0x100-0x13c.

Note: The parameter values within the **Constant/Default Timing Generation Options** will also be the values used during timing generation when the Include AXI4-Lite Register Interface parameter is disabled. These parameter values will be used when the core is in constant mode when it does not have an AXI4-Lite interface.

Example Using the Default 720p Settings

Start with the default 720p settings without any fine timing adjustment settings:

The screenshot shows the configuration interface for the Video Timing Controller, specifically the 'Default/Constant' tab. The 'Video Format' is set to 'Custom'. Under 'Horizontal Settings', the values are: Active Size 1280, Frame Size 1650, Sync Start 1390, and Sync End 1430. The 'Frame/Field 0 Vertical Settings' are: Active Size 720, Frame Size 750, Sync Start 724, and Sync End 729. The 'Frame/Field 0 Horizontal Fine Adjustment' settings are: Vblank Start 1285, Vblank End 1645, VSync Start 1280, and VSync End 1280. The 'Field 1 Vertical Settings' are: Interlaced (unchecked), Frame Size 750, Sync Start 724, and Sync End 729. The 'Field 1 Horizontal Fine Adjustment' settings are: Vblank Start 1280, Vblank End 1280, VSync Start 1280, and VSync End 1280. The 'Active Polarity' settings are: Field ID High, Vblank High, Hblank High, Vsync High, Hsync High, Active Video High, and Active Chroma High.

In simulation, look at the VTC output. Note that the pixel clock for 720p should be 74.5 MHz, equivalent to a period of 13.4 ns.

By default, the blanking signal rises at the same clock edge the last active video signal (of a frame) falls and falls at the same clock edge the first active video signal (of a frame) rises.

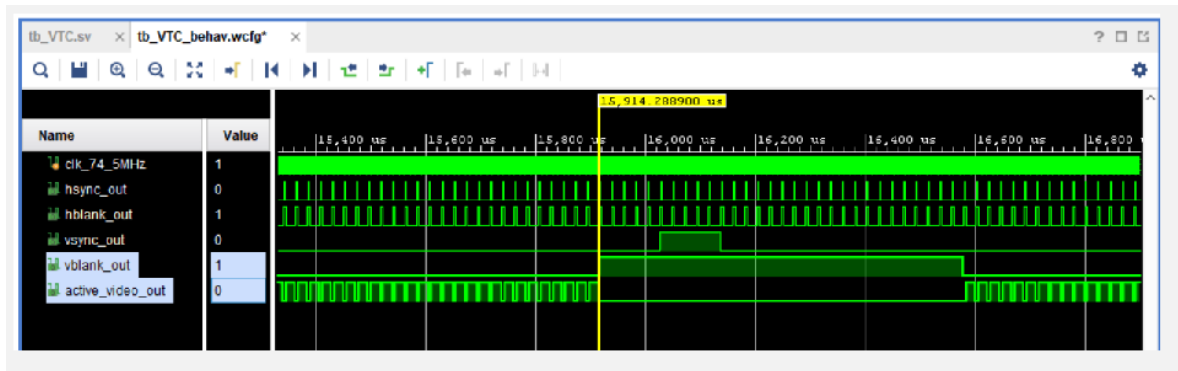

Also by default, the `vsync` signals rises and falls at the same clock edge as a rising edge of the 6th rising edge of the `hblank` signal.



Both behaviors are because only the Vertical timing in Lines count are configured, not in pixel count, defined in the video timing specifications.

But, for whatever reason, you might want to slightly change the configuration to move the Vertical blanking or Sync signals. Use the Horizontal Fine Adjustment Settings to do so.

Start by the blanking. using he following configuration:

`vblank start = 1285` and `vblank End = 1645`

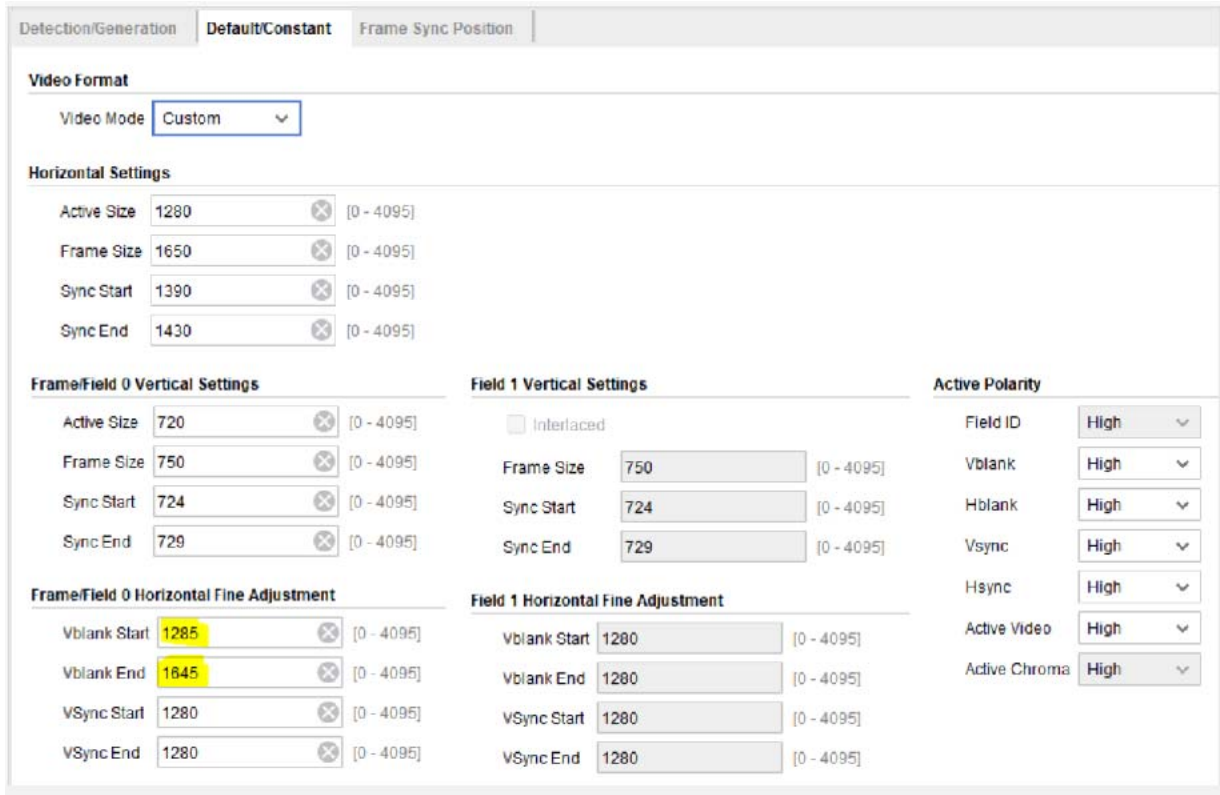

Now check the VTC outputs in simulation and regenerate the IP output products.

Notice that the blanking signal rises 67 ns after the the active out signal falls. This correspond to 5 pixel clock periods. Taking the time from the last hblank signals of the active frame (indicating the last line), it corresponds to 1285 pixel clock periods (active size + 5).

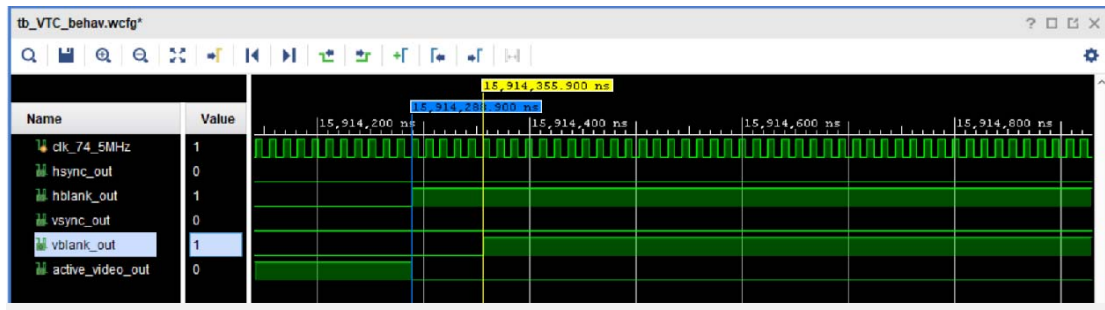

Notice that blanking signal falls 67 ns before the active out signal rises. This correspond to 5 pixel clock periods. Taking the time from the last hblank signals during the vertical blanking, it corresponds to 1645 pixel clock periods (horizontal frame size - 5).

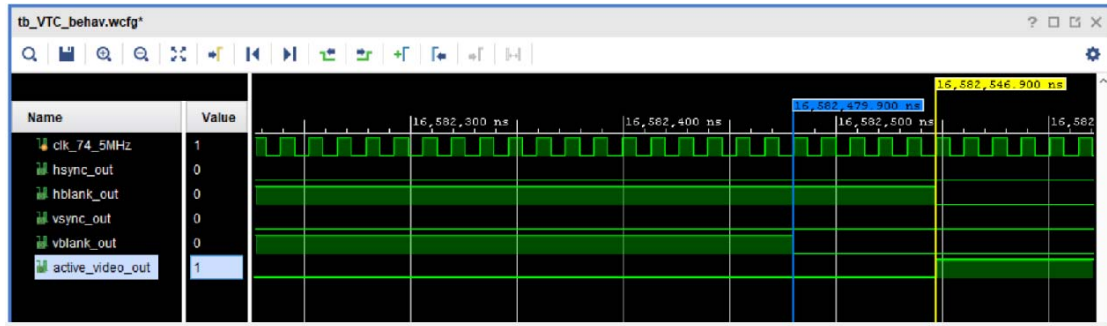

Now change the Vsync start and End (0 and 1275):

The configuration window is titled "Detection/Generation Default/Constant Frame Sync Position". It contains several sections:

- Video Format:** Video Mode is set to "Custom".
- Horizontal Settings:** Active Size: 1280, Frame Size: 1650, Sync Start: 1390, Sync End: 1430.
- Frame/Field 0 Vertical Settings:** Active Size: 720, Frame Size: 750, Sync Start: 724, Sync End: 729.
- Field 1 Vertical Settings:** Interlaced: . Frame Size: 750, Sync Start: 724, Sync End: 729.
- Active Polarity:** Field ID: High, Vblank: High, Hblank: High, Vsync: High, Hsync: High, Active Video: High, Active Chroma: High.
- Frame/Field 0 Horizontal Fine Adjustment:** Vblank Start: 1280, Vblank End: 1280, VSync Start: 0, VSync End: 1275.
- Field 1 Horizontal Fine Adjustment:** Vblank Start: 1280, Vblank End: 1280, VSync Start: 1280, VSync End: 1280.

Then check the output in simulation.

Notice that the `vsync` signal rises when the 5th falling edge of the `hblank` signal when the vertical blanking signals occur.

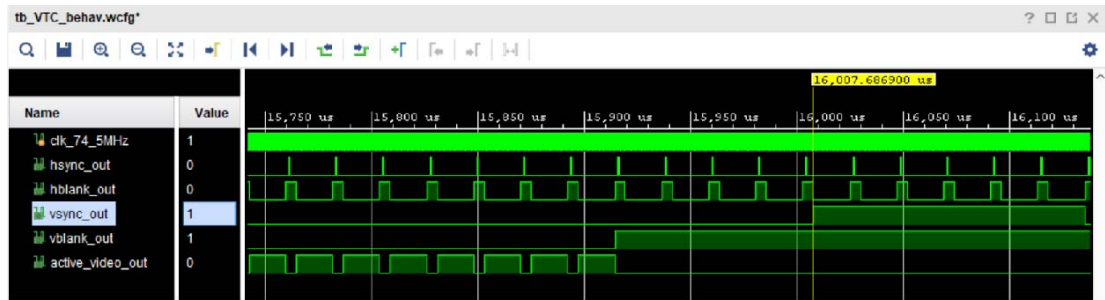

And the vsync signal falls 5 clock cycles before the rising edge of a hblank.

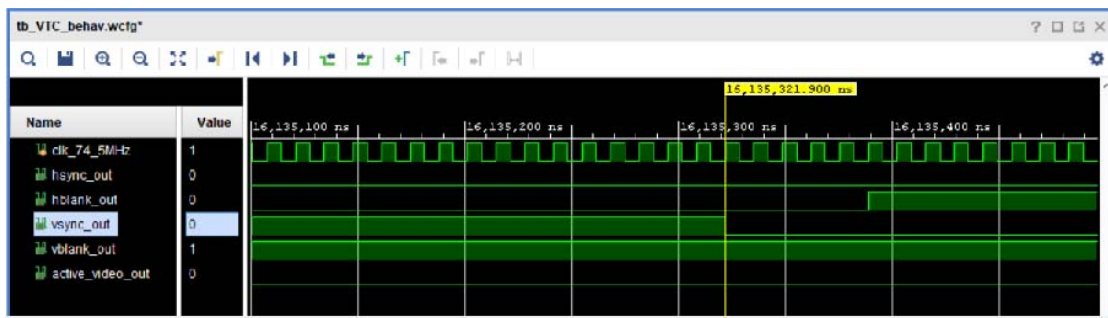

In summary, the Horizontal Fine adjustment allows you to move the Vertical timing signals in clock cycle precision while it is usually defined in Line precision.

Output Generation

Vivado generates the files necessary to build the core and place those files in the <project>/<project>.srcs/sources_1/ip/<core> directory.

File Details

The Vivado tools output consists of some or all the following files.

Table 4-1: Vivado Software Output

Name	Description
v_tc_v6_1	Library directory for the v_tc_v6_1 core IP-XACT XML file describes which options were used to generate the core. An XCI file can also be used as a source file.
v_tc_v6_1.veo	Verilog instantiation template
v_tc_v6_1.vho	VHDL instantiation template

Table 4-1: Vivado Software Output (Cont'd)

Name	Description
v_tc_v6_1.xci	IP-XACT XML file describes which options were used to generate the core. An XCI file can also be used as a source file.
v_tc_v6_1.xml	IP-XACT XML file describes how the core is constructed to build the core.

Constraining the Core

Required Constraints

The only constraints required are clock frequency constraints for the video clock, `clk`, and the AXI4-Lite clock, `s_axi_aclk`. Paths between the two clock domains should be constrained with a `max_delay` constraint and use the `datapathonly` flag, causing setup and hold checks to be ignored for signals that cross clock domains. These constraints are provided in the XDC constraints file included with the core.

Simulation

This chapter contains information about simulating IP in the Vivado[®] Design Suite environment. For comprehensive information about Vivado simulation components, as well as information about using supported third party tools, see the *Vivado Design Suite User Guide: Logic Simulation* (UG900) [[Ref 6](#)].

Synthesis and Implementation

For details about synthesis and implementation, see “Synthesizing IP” and “Implementing IP” in the *Vivado Design Suite User Guide: Designing with IP* (UG896) [Ref 3].

Detailed Example Design

No example design is available at the time for the Video Timing Controller v6.1 core.

Test Bench

This chapter contains information about the provided test bench in the Vivado[®] Design Suite environment.

Demonstration Test Bench

A demonstration test bench is provided with the core which enables you to observe core behavior in a typical scenario. This test bench is generated together with the core in Vivado Design Suite. You are encouraged to make simple modifications to the configurations and observe the changes in the waveform.

Directory and File Contents

The following files are expected to be generated in the in the demonstration test bench output directory:

- `axi4lite_mst.v`
- `axi4s_video_mst.v`
- `axi4s_video_slv.v`
- `ce_generator.v`
- `tb_<IP_instance_name>.v`

Test Bench Structure

The top-level entity is `tb_<IP_instance_name>`.

It instantiates the following modules:

- DUT
The <IP> core instance under test.
- `axi4lite_mst`

The AXI4-Lite master module, which initiates AXI4-Lite transactions to program core registers.

- `axi4s_video_mst`

The AXI4-Stream master module, which generates ramp data and initiates AXI4-Stream transactions to provide video stimuli for the core and can also be used to open stimuli files and convert them into corresponding AXI4-Stream transactions.

To do this, edit `tb_<IP_instance_name>.v`:

- Add define macro for the stimuli file name and directory path

```
define STIMULI_FILE_NAME<path><filename>.
```
- Comment-out/remove the following line:

```
MST.is_ramp_gen(`C_ACTIVE_ROWS, `C_ACTIVE_COLS, 2);
```

 and replace with the following line:

```
MST.use_file(`STIMULI_FILE_NAME);
```

- `axi4s_video_slv`

The AXI4-Stream slave module, which acts as a passive slave to provide handshake signals for the AXI4-Stream transactions from the core output, can be used to open the data files and verify the output from the core.

To do this, edit `tb_<IP_instance_name>.v`:

- Add define macro for the golden file name and directory path

```
define GOLDEN_FILE_NAME "<path><filename>".
```
- Comment out the following line:

```
SLV.is_passive;
```

 and replace with the following line:

```
SLV.use_file(`GOLDEN_FILE_NAME);
```

- `ce_gen`

Programmable Clock Enable (ACLKEN) generator.

Verification, Compliance, and Interoperability

Simulation

A highly parameterizable test bench was used to test the Video Timing Controller core. Testing included the following:

- Register accesses
- Processing of multiple frames of data
- Testing of various frame sizes including 1080p, 720p, and 480p
- Varying instantiations of the core
- Varying the polarity of input and output signals
- Varying the horizontal offset of the vertical timing signals
- Regenerating the input on the output
- Testing of various interrupts

Hardware Testing

The Video Timing Controller core has been tested in a variety of hardware platforms at Xilinx® to represent a variety of parameterizations, including the following:

- A test design was developed for the core that incorporated a MicroBlaze™ processor, AXI4 Interconnect and various other peripherals. The software for the test system included live video input for the Video Timing Controller core. The Video Timing Controller, in addition to live video, was also connected in loopback allow the generator to feed the detector for a robust loopback test. Various tests could be supported by varying the configuration of the Timing Controller core or by loading a different software executable. The MicroBlaze processor was responsible for:
 - Initializing the appropriate input and output buffers in external memory.

- Initializing the Video Timing Controller core.
- Initializing the HDMI/DVI input and output cores for live video.
- Launching the test.
- Configuring the Video Timing Controller for various input frame sizes and checking the detection/generation loopback connection for correct video detection
- Controlling the peripherals including the UART and AXI VDMMAs.

Upgrading

This appendix contains information about migrating from an ISE design to the Vivado Design Suite, and for upgrading to a more recent version of the IP core. For customers upgrading their IP core, important details (where applicable) about any port changes and other impact to user logic are included.

Migrating to the Vivado Design Suite

For information about migration to Vivado Design Suite, see *ISE to Vivado Design Suite Migration Guide* (UG911) [Ref 2].

Upgrading in Vivado Design Suite

This section provides information about any changes to the user logic or port designations that take place when you upgrade to a more current version of this IP core in the Vivado Design Suite.

Parameter Changes

The Video Timing Controller v5.00.a added parameters for configuring the core in constant mode, thus the core can be initialized to generate timing after reset without a processor or software.

Port Changes

The Video Timing Controller v5.00.a removed all GPP interface ports. The Video Timing Controller v4.00.a.0 added the ability to operate on video frame sizes up to 8192 x 8192. Previous versions supported 4096 x 4096 maximum. If the maximum sizes of 8192 are selected, some GPP ports will be 13 bits wide where on previous versions of the core, these ports were 12 bits.

The Video Timing Controller v4.00.a also added the ability to detect and generate vertical signals with a horizontal offset. In order to report the horizontal start cycle of these vertical signals, the Video Timing Controller v4.00.a added the following new ports:

- gen_v0blank_hstart
- gen_v0blank_hend
- gen_v0sync_hstart
- gen_v0sync_hend
- det_v0blank_hstart
- det_v0blank_hend
- det_v0sync_hstart
- det_v0sync_hend

Other Changes

Migrating to the AXI4-Lite Interface

The Video Timing Controller v4.00.a changed from the PLB processor interface to the AXI4-Lite interface. As a result, all of the PLB-related connections have been replaced with an AXI4-Lite interface. For more information, see the *AXI Reference Guide* [Ref 1].

Functionality Changes

The Video Timing Controller v5.00.a AXI4-Lite register definitions changed from the previous version, simplifying the address map. The Video Timing Controller v5.00.a also added parameters for configuring the core in constant mode, thus the core can be initialized to generate timing after reset without a processor or software. The Video Timing Controller v3.0 added the ability to operate on video frame sizes up to 8192 x 8192. Previous versions supported 4096 x 4096 maximum.

The Video Timing Controller v3.0 also added the ability to detect and generate vertical signals with a horizontal delay offset.

Special Considerations when Migrating to AXI

The Video Timing Controller v3.0 added the support for the AXI4-Lite interface with this version. When using the Video Timing Controller v3.0, note that the core name changed from "timebase" to "axi_vtc". All software driver functions, data structures and filenames also changed from a "xtimebase" prefix to "xvtc" prefix.

Debugging

This appendix includes details about resources available on the Xilinx Support website and debugging tools.

Finding Help on Xilinx.com

To help in the design and debug process when using the Video Timing Controller, the [Xilinx Support web page](#) contains key resources such as product documentation, release notes, answer records, information about known issues, and links for opening a Technical Support Web Case.

Documentation

This product guide is the main document associated with the Video Timing Controller. This guide, along with documentation related to all products that aid in the design process, can be found on the [Xilinx Support web page](#) or by using the Xilinx Documentation Navigator.

Download the Xilinx Documentation Navigator from the [Downloads page](#). For more information about this tool and the features available, open the online help after installation.

Answer Records

Answer Records include information about commonly encountered problems, helpful information on how to resolve these problems, and any known issues with a Xilinx product. Answer Records are created and maintained daily ensuring that users have access to the most accurate information available.

Answer Records for this core are listed below, and can also be located by using the Search Support box on the main [Xilinx support web page](#). To maximize your search results, use proper keywords such as

- Product name
- Tool message(s)
- Summary of the issue encountered

A filter search is available after results are returned to further target the results.

Answer Records for the Video Timing Controller Core

AR 54541

<http://Xilinx Support web page/answers/54541.htm>

Technical Support

Xilinx provides technical support in the [Xilinx Support web page](#) for this LogiCORE™ IP product when used as described in the product documentation. Xilinx cannot guarantee timing, functionality, or support if you do any of the following:

- Implement the solution in devices that are not defined in the documentation.
- Customize the solution beyond that allowed in the product documentation.
- Change any section of the design labeled DO NOT MODIFY.

Xilinx provides premier technical support for customers encountering issues that require additional assistance.

To contact Xilinx Technical Support, navigate to the [Xilinx Support web page](#).

1. Open a WebCase by selecting the [WebCase](#) link located under Support Quick Links.
 - A block diagram of the video system that explains the video source, destination and IP (custom and Xilinx) used.

Note: Access to WebCase is not available in all cases. Please login to the WebCase tool to see your specific support options.

Debug Tools

There are many tools available to address Video Timing Controller design issues. It is important to know which tools are useful for debugging various situations.

Example Design

The Video Timing Controller is delivered with an example test bench. Information about the example test bench can be found in *Chapter 6, Example Design for the Vivado Design Suite*.

Vivado Design Suite Debug Feature

Vivado inserts logic analyzer and virtual I/O cores directly into your design. Vivado Lab Tools allows you to set trigger conditions to capture application and integrated block port signals in hardware. Captured signals can then be analyzed. This feature represents the

functionality in the Vivado IDE that is used for logic debugging and validation of a design running in Xilinx FPGA devices in hardware.

The Vivado logic analyzer is used to interact with the logic debug LogiCORE IP cores, including:

- ILA 2.0 (and later versions)
- VIO 2.0 (and later versions)

Reference Boards

Various Xilinx development boards support Video Timing Controller. These boards can be used to prototype designs and establish that the core can communicate with the system.

- 7 series evaluation boards
 - KC705
 - ZC702

License Checkers

If the IP requires a license key, the key must be verified. The Vivado tool flows have a number of license check points for gating licensed IP through the flow. If the license check succeeds, the IP may continue generation. Otherwise, generation halts with error. License checkpoints are enforced by the following tools:

- RDS
- RDI
- Bitgen



IMPORTANT: *IP license level is ignored at checkpoints. The test confirms a valid license exists. It does not check IP license level.*

Hardware Debug

Hardware issues can range from link bring-up to problems seen after hours of testing. This section provides debug steps for common issues. The ChipScope tool is a valuable resource to use in hardware debug. The signal names mentioned in the following individual sections can be probed using the ChipScope tool for debugging the specific problems.

Many of these common issues can also be applied to debugging design simulations. Details are provided on General Checks

General Checks

Ensure that all the timing constraints for the core were properly incorporated from the example design and that all constraints were met during implementation.

- Does it work in post-place and route timing simulation? If problems are seen in hardware but not in timing simulation, this could indicate a PCB issue. Ensure that all clock sources are active and clean.
- If using MMCMs in the design, ensure that all MMCMs have obtained lock by monitoring the LOCKED port.
- If your outputs go to 0, check your licensing. The evaluation version of the core will time out after running for 8 hours at 75 MHz.

Evaluation Core Timeout

The Video Timing Controller hardware evaluation core times out after approximately eight hours of operation. The output is driven to zero. This results in a dark-green screen for YUV color systems and possibly loss of lock on output monitors.

Interface Debug

AXI4-Lite Interfaces

Table C-1 describes how to troubleshoot the AXI4-Lite interface.

Table C-1: Troubleshooting the AXI4-Lite Interface

Symptom	Solution
Readback from the Version Register through the AXI4-Lite interface times out, or a core instance without an AXI4-Lite interface seems non-responsive.	Are the S_AXI_ACLK and ACLK pins connected? The VERSION_REGISTER readout issue may be indicative of the core not receiving the AXI4-Lite interface.
Readback from the Version Register through the AXI4-Lite interface times out, or a core instance without an AXI4-Lite interface seems non-responsive.	Is the core enabled? Is s_axi_aclken connected to vcc? Verify that signal ACLKEN is connected to either net_vcc or to a designated clock enable signal.

Table C-1: Troubleshooting the AXI4-Lite Interface (Cont'd)

Symptom	Solution
Readback from the Version Register through the AXI4-Lite interface times out, or a core instance without an AXI4-Lite interface seems non-responsive.	Is the core in reset? S_AXI_ARESETn and ARESETn should be connected to vcc for the core not to be in reset. Verify that the S_AXI_ARESETn and ARESETn signals are connected to either net_vcc or to a designated reset signal.
Readback value for the VERSION_REGISTER is different from expected default values	The core and/or the driver in a legacy project has not been updated. Ensure that old core versions, implementation files, and implementation caches have been cleared.

Assuming the AXI4-Lite interface works, the second step is to bring up the AXI4-Stream interfaces.

Other Interfaces

Table C-2 describes how to troubleshoot third-party interfaces.

Table C-2: Troubleshooting Third-Party Interfaces

Symptom	Solution
Severe color distortion or color-swap when interfacing to third-party video IP.	Verify that the color component logical addressing on the AXI4-Stream TDATA signal is in according to <i>Data Interface</i> in Chapter 2. If misaligned: In HDL, break up the TDATA vector to constituent components and manually connect the slave and master interface sides.
Severe color distortion or color-swap when processing video written to external memory using the AXI-VDMA core.	Unless the particular software driver was developed with the AXI4-Stream TDATA signal color component assignments described in <i>Data Interface</i> in Chapter 2 in mind, there are no guarantees that the software correctly identifies bits corresponding to color components. Verify that the color component logical addressing TDATA is in alignment with the data format expected by the software drivers reading/writing external memory. If misaligned: In HDL, break up the TDATA vector to constituent components, and manually connect the slave and master interface sides.

Additional Resources

Xilinx Resources

For support resources such as Answers, Documentation, Downloads, and Forums, see the Xilinx Support website at:

<http://Xilinx Support web page>.

For a glossary of technical terms used in Xilinx documentation, see:

https://www.xilinx.com/support/documentation/sw_manuals/glossary.pdf.

For a comprehensive listing of Video and Imaging application notes, white papers, reference designs and related IP cores, see the Video and Imaging Resources page at:

https://www.xilinx.com/esp/video/refdes_listing.htm#ref_des.

Documentation Navigator and Design Hubs

Xilinx Documentation Navigator provides access to Xilinx documents, videos, and support resources, which you can filter and search to find information. To open the Xilinx Documentation Navigator (DocNav):

- From the Vivado IDE, select **Help > Documentation and Tutorials**.
- On Windows, select **Start > All Programs > Xilinx Design Tools > DocNav**.
- At the Linux command prompt, enter `docnav`.

Xilinx Design Hubs provide links to documentation organized by design tasks and other topics, which you can use to learn key concepts and address frequently asked questions. To access the Design Hubs:

- In the Xilinx Documentation Navigator, click the **Design Hubs View** tab.
- On the Xilinx website, see the [Design Hubs](#) page.

Note: For more information on Documentation Navigator, see the [Documentation Navigator](#) page on the Xilinx website.

References

These documents provide supplemental material useful with this user guide:

1. *Vivado AXI Reference Guide* ([UG1037](#))
2. *ISE to Vivado Design Suite Migration Guide* ([UG911](#))
3. *Vivado Design Suite User Guide: Designing with IP* ([UG896](#))
4. *Vivado Design Suite User Guide: Programming and Debugging* ([UG908](#))
5. *Vivado Design Suite User Guide: Getting Started* ([UG910](#))
6. *Vivado Design Suite User Guide: Logic Simulation* ([UG900](#))
7. *Vivado Design Suite User Guide: Designing IP Subsystems Using IP Integrator* ([UG994](#))

Revision History

The following table shows the revision history for this document.

Date	Version	Revision
05/22/2019	6.1	Updated Table 2-3 .
02/12/2019	6.1	Added new register for Field1 Active lines for all interlaced modes.
10/04/2017	6.1	Updated the fsync_in Pin section. Updated Control Signals and Timing section to describe dual/quad pixel mode.
11/18/2015	6.1	Added UltraScale+ support.
10/01/2014	6.1	Removed Application Software Development appendix.
12/18/2013	6.1	Added UltraScale Architecture support. Added interlaced video support
10/02/2013	6.0	Synch document version with core version. Updated Constraints.
03/20/2013	4.0	Updated for core version to v6.0. Updated Debugging appendix. Removed ISE chapters. Added new <code>det_clken</code> , and <code>gen_clken</code> pins, new Clocking pins, Resets, <code>DET_ENABLE</code> and <code>GEN_ENABLE</code> bits.
10/16/2012	3.1	Updated for core version and ISE v14.3 and Vivado v2012.3. Added Vivado test bench and constraints.
07/25/2012	3.0	Updated for core version. Added Vivado information.
4/24/2012	2.0	Updated for core version. Added Zynq-7000 devices, deprecated GPP interface.
10/19/2011	1.0	Initial Xilinx release of Product Guide, replacing DS857.

Please Read: Important Legal Notices

The information disclosed to you hereunder (the "Materials") is provided solely for the selection and use of Xilinx products. To the maximum extent permitted by applicable law: (1) Materials are made available "AS IS" and with all faults, Xilinx hereby DISCLAIMS ALL WARRANTIES AND CONDITIONS, EXPRESS, IMPLIED, OR STATUTORY, INCLUDING BUT NOT LIMITED TO WARRANTIES OF MERCHANTABILITY, NON-INFRINGEMENT, OR FITNESS FOR ANY PARTICULAR PURPOSE; and (2) Xilinx shall not be liable (whether in contract or tort, including negligence, or under any other theory of liability) for any loss or damage of any kind or nature related to, arising under, or in connection with, the Materials (including your use of the Materials), including for any direct, indirect, special, incidental, or consequential loss or damage (including loss of data, profits, goodwill, or any type of loss or damage suffered as a result of any action brought by a third party) even if such damage or loss was reasonably foreseeable or Xilinx had been advised of the possibility of the same. Xilinx assumes no obligation to correct any errors contained in the Materials or to notify you of updates to the Materials or to product specifications. You may not reproduce, modify, distribute, or publicly display the Materials without prior written consent. Certain products are subject to the terms and conditions of Xilinx's limited warranty, please refer to Xilinx's Terms of Sale which can be viewed at <https://www.xilinx.com/legal.htm#tos>; IP cores may be subject to warranty and support terms contained in a license issued to you by Xilinx. Xilinx products are not designed or intended to be fail-safe or for use in any application requiring fail-safe performance; you assume sole risk and liability for use of Xilinx products in such critical applications, please refer to Xilinx's Terms of Sale which can be viewed at <https://www.xilinx.com/legal.htm#tos>.

AUTOMOTIVE APPLICATIONS DISCLAIMER

AUTOMOTIVE PRODUCTS (IDENTIFIED AS "XA" IN THE PART NUMBER) ARE NOT WARRANTED FOR USE IN THE DEPLOYMENT OF AIRBAGS OR FOR USE IN APPLICATIONS THAT AFFECT CONTROL OF A VEHICLE ("SAFETY APPLICATION") UNLESS THERE IS A SAFETY CONCEPT OR REDUNDANCY FEATURE CONSISTENT WITH THE ISO 26262 AUTOMOTIVE SAFETY STANDARD ("SAFETY DESIGN"). CUSTOMER SHALL, PRIOR TO USING OR DISTRIBUTING ANY SYSTEMS THAT INCORPORATE PRODUCTS, THOROUGHLY TEST SUCH SYSTEMS FOR SAFETY PURPOSES. USE OF PRODUCTS IN A SAFETY APPLICATION WITHOUT A SAFETY DESIGN IS FULLY AT THE RISK OF CUSTOMER, SUBJECT ONLY TO APPLICABLE LAWS AND REGULATIONS GOVERNING LIMITATIONS ON PRODUCT LIABILITY.

© Copyright 2011-2019 Xilinx, Inc. Xilinx, the Xilinx logo, Artix, ISE, Kintex, Spartan, Virtex, Zynq, and other designated brands included herein are trademarks of Xilinx in the United States and other countries. All other trademarks are the property of their respective owners.