

# LogiCORE IP YCrCb to RGB Color-Space Converter v6.01a

## *Product Guide*

PG014 October 16, 2012

# Table of Contents

## SECTION I: SUMMARY

### IP Facts

#### Chapter 1: Overview

Feature Summary . . . . .	7
Applications . . . . .	8
Licensing and Ordering Information . . . . .	8

#### Chapter 2: Product Specification

Standards . . . . .	9
Performance . . . . .	9
Resource Utilization . . . . .	10
Core Interfaces and Register Space . . . . .	12

#### Chapter 3: Designing with the Core

General Design Guidelines . . . . .	26
Color-Space Conversion Background . . . . .	27
Clock, Enable, and Reset Considerations . . . . .	33
System Considerations . . . . .	35

#### Chapter 4: C Model Reference

Installation and Directory Structure . . . . .	38
Using the C-Model . . . . .	40
Compiling with the YCrCb to RGB C-Model . . . . .	46

## SECTION II: VIVADO DESIGN SUITE

#### Chapter 5: Customizing and Generating the Core

Graphical User Interface . . . . .	49
Output Generation . . . . .	53

## Chapter 6: Constraining the Core

Required Constraints .....	54
Device, Package, and Speed Grade Selections .....	54
Clock Frequencies .....	55
Clock Management .....	55
Clock Placement .....	55
Banking .....	55
Transceiver Placement .....	55
I/O Standard and Placement .....	55

## Chapter 7: Detailed Example Design

Demonstration Test Bench .....	56
--------------------------------	----

## SECTION III: ISE DESIGN SUITE

## Chapter 8: Customizing and Generating the Core

Graphical User Interface .....	62
Parameter Values in the XCO File .....	66
Output Generation .....	67

## Chapter 9: Constraining the Core

Required Constraints .....	69
Device, Package, and Speed Grade Selections .....	69
Clock Frequencies .....	70
Clock Management .....	70
Clock Placement .....	70
Banking .....	70
Transceiver Placement .....	70
I/O Standard and Placement .....	70

## Chapter 10: Detailed Example Design

Demonstration Test Bench .....	71
Test Bench Structure .....	71
Running the Simulation .....	72
Directory and File Contents .....	72

## SECTION IV: APPENDICES

### Appendix A: Verification, Compliance, and Interoperability

Simulation .....	75
Hardware Testing .....	75
Interoperability .....	76

### Appendix B: Migrating

### Appendix C: Debugging

Bringing up the AXI4-Lite Interface .....	78
Bringing up the AXI4-Stream Interfaces .....	79
Debugging Features .....	81
Interfacing to Third-Party IP .....	82

### Appendix D: Application Software Development

Programmer Guide .....	84
------------------------	----

### Appendix E: Additional Resources

Xilinx Resources .....	88
Solution Centers .....	88
References .....	88
Technical Support .....	89
Revision History .....	89
Notice of Disclaimer .....	90

# SECTION I: SUMMARY

IP Facts

Overview

Product Specification

Designing with the Core

C Model Reference

## Introduction

The Xilinx LogiCORE™ IP YCrCb to RGB Color-Space Converter core is a simplified 3x3 matrix multiplier converting three input color samples to three output samples in a single clock cycle. The optimized structure uses only four XtremeDSP™ slices by taking advantage of the dependencies between coefficients in the conversion matrix of most YCrCb 4:4:4 or YUV 4:4:4 to RGB standards.

## Features

- Built-in support for:
  - SD (ITU 601)
  - HD (ITU 709) PAL
  - HD (ITU 709) NTSC
  - YUV
- Support for user-defined conversion matrices
- AXI4-Stream data interfaces
- Optional AXI4-Lite control interface
- Supports 8, 10, 12 and 16-bit per color component input and output
- Built-in, optional bypass and test-pattern generator mode
- Built-in, optional throughput monitors
- Supports spatial resolutions from 32x32 up to 7680x7680
  - Supports 1080P60 in all supported device families <sup>(1)</sup>
  - Supports 4kx2k @ 24 Hz in supported high performance devices

1. Performance on low power devices may be lower.

LogiCORE IP Facts Table	
<b>Core Specifics</b>	
Supported Device Family <sup>(1)</sup>	Zynq™-7000, Artix™-7, Virtex®-7, Kintex™-7, Virtex-6, Spartan®-6
Supported User Interfaces	AXI4-Lite, AXI4-Stream <sup>(3)</sup>
Resources	See <a href="#">Table 2-1</a> through <a href="#">Table 2-8</a>
<b>Provided with Core</b>	
Documentation	Product Guide
Design Files	ISE: NGC netlist, Encrypted HDL Vivado: Encrypted RTL
Example Design	Not Provided
Test Bench	Verilog <sup>(4)</sup>
Constraints File	Not Provided
Simulation Models	VHDL or Verilog Structural, C-Model <sup>(4)</sup>
Supported Software Drivers	Not Applicable
<b>Tested Design Flows <sup>(6)</sup></b>	
Design Entry Tools	ISE Design Suite v14.3, Vivado™ 2012.3 Design Suite <sup>(7)</sup> , Platform Studio (XPS) 14.3
Simulation <sup>(5)</sup>	Mentor Graphics ModelSim, Xilinx® ISim 14.3
Synthesis Tools	Xilinx Synthesis Technology (XST) Vivado Synthesis
<b>Support</b>	
Provided by Xilinx, Inc.	

1. For a complete listing of supported devices, see the [release notes](#) for this core.
2. Supported in ISE Design Suite implementations only.
3. Video protocol as defined in the *Video IP: AXI Feature Adoption* section of (UG761) *AXI Reference Guide* [Ref 10].
4. HDL test bench and C-Model available on the product page on Xilinx.com at [http://www.xilinx.com/products/intellectual-property/YCrCb\\_to\\_RGB.htm](http://www.xilinx.com/products/intellectual-property/YCrCb_to_RGB.htm).
5. For the supported versions of the tools, see the [ISE Design Suite 14: Release Notes Guide](#).
6. For the supported versions of the tools, see the [Xilinx Design Tools: Release Notes Guide](#).
7. Supports only 7 series devices.

# Overview

A color space is a mathematical representation of a set of colors. The two most popular color models are:

- RGB or R'G'B', gamma corrected RGB, used in computer graphics
- YIQ, YUV and YCrCb used in video systems

These color spaces are directly related to the intuitive notions of hue, saturation and brightness.

All color spaces can be derived from the RGB information supplied by devices such as cameras and scanners. Different color spaces have historically evolved for different applications. In each case, a color space was chosen for application-specific reasons.

The convergence of computers, the Internet and a wide variety of video devices, all using different color representations, is forcing the digital designer today to convert between them. The objective is to have all inputs converted to a common color space before algorithms and processes are executed. Converters are useful for a number of markets, including image and video processing.

---

## Feature Summary

The YCrCb to RGB Color-Space Converter core transforms YCrCb 4:4:4 or YUV 4:4:4 video data into RGB video data. The core supports a 4 common format conversions as well as custom mode that allows for a user-defined transform. The core is capable of a maximum resolution of 7680 columns by 7680 rows with 8, 10, 12, or 16 bits per pixel and supports the bandwidth necessary for High-definition (1080p60) resolutions in all Xilinx FPGA device families. Higher resolutions can be supported in Xilinx high-performance device families.

You can configure and instantiate the core from CORE Generator or EDK tools. Core functionality may be controlled dynamically with an optional AXI4-Lite interface.

---

## Applications

- Post-processing core for image data
  - Video surveillance
  - Video conferencing
  - Machine vision
  - Other imaging applications
- 

## Licensing and Ordering Information

This Xilinx LogiCORE IP module is provided under the terms of the [Xilinx Core License Agreement](#). The module is shipped as part of the Vivado Design Suite and ISE Design Suite. For full access to all core functionalities in simulation and in hardware, you must purchase a license for the core. Contact your [local Xilinx sales representative](#) for information about pricing and availability.

For more information, visit the YCrCb to RGB Color-Space Converter product web page.



# Product Specification

---

## Standards

The YCrCb to RGB Color-Space Converter core is compliant with the AXI4-Stream Video Protocol and AXI4-Lite interconnect standards. Refer to the *Video IP: AXI Feature Adoption* section of the (UG761) *AXI Reference Guide* [Ref 10] for additional information.

---

## Performance

The following sections detail the performance characteristics of the YCrCb to RGB Color-Space Converter core.

### Maximum Frequencies

The maximum achievable clock frequency can vary. The maximum achievable clock frequency and all resource counts can be affected by other tool options, additional logic in the FPGA device, using a different version of Xilinx tools and other factors. Refer to in [Table 2-1](#) through [Table 2-5](#) for device-specific information.

### Latency

The processing latency of the core is shown in the following equation:

$$\text{Latency} = 9 + 1(\text{if has clipping}) + 1(\text{if has clamping})$$

This code evaluates to 11 clock cycles for typical cases (unless in "custom" mode the clipping and/or clamping circuits are not used).

### Throughput

The YCrCb to RGB Color Space Converter core outputs one YCbCr 4:4:4 sample per clock cycle.

## Resource Utilization

For an accurate measure of the usage of primitives, slices, and CLBs for a particular instance, check the **Display Core Viewer after Generation** check box in the CORE Generator interface.

### Resource Utilization using ISE Tools

The information presented in [Table 2-1](#) through [Table 2-5](#) is a guide to the resource utilization and maximum clock frequency of the YCrCb to RGB Color Space Converter core for all input/output width combinations for Virtex-7, Kintex-7, Artix-7, Zynq-7000, Virtex-6, and Spartan-6 FPGA families. The Xtreme DSP Slice count is always 4, regardless of parameterization, and this core does not use any dedicated I/O or CLK resources. The design was tested using ISE<sup>®</sup> v14.3 tools with default tool options for characterization data.

*Table 2-1: Spartan-6*

Data Width	Slice FFs	Slice LUTs	LUT6-FF pairs	DSP48A1s	Clock Freq (Mhz)
8	231	311	322	4	188
10	258	343	350	4	188
12	284	364	376	4	188
16	336	414	420	4	180

1. Speedfile: XC6SLX25 FGG484

*Table 2-2: Virtex-7*

Data Width	Slice FFs	Slice LUTs	LUT6-FF pairs	DSP48A1s	Clock Freq (Mhz)
8	223	276	286	4	312
10	250	297	315	4	296
12	276	316	346	4	296
16	328	359	397	4	288

1. Speedfile: XC7V585T FFG1157

**Table 2-3: Virtex-6**

Data Width	Slice FFs	Slice LUTs	LUT6-FF pairs	DSP48A1s	Clock Freq (Mhz)
8	223	275	293	4	274
10	250	297	320	4	296
12	276	318	347	4	226
16	328	362	399	4	274

1. Speedfile: XC6VLX75T FF484

**Table 2-4: Kintex-7 (Zynq-7000 XC7Z010 and XC7Z020)**

Data Width	Slice FFs	Slice LUTs	LUT6-FF pairs	DSP48A1s	Clock Freq (Mhz)
8	223	272	291	4	304
10	250	295	316	4	320
12	276	320	341	4	288
16	328	367	389	4	320

1. Speedfile: XC7K70T FBG484

**Table 2-5: Artix-7 (Zynq-7000 XC7Z030 and XC7Z045)**

Data Width	Slice FFs	Slice LUTs	LUT6-FF pairs	DSP48A1s	Clock Freq (Mhz)
8	223	276	295	4	196
10	250	298	320	4	219
12	276	319	346	4	212
16	328	366	398	4	212

1. Speedfile: XC7A100T FGG484

## Resource Utilization using Vivado Tools

Table 2-6 through Table 2-8 were generated using Vivado Design Suite 2012.3 with default tool options for characterization data.

Table 2-6: Virtex-7

Data Width	Slice FFs	Slice LUTs	LUT6-FF pairs	DSP48A1s	Clock Freq (Mhz)
8	245	268	302	8	234
10	285	298	336	8	234
12	325	327	381	8	234
16	405	424	487	8	242

1. Speedfile: XC7V585T FFG1157

Table 2-7: Kintex-7 (Zynq-7000 XC7Z010 and XC7Z020)

Data Width	Slice FFs	Slice LUTs	LUT6-FF pairs	DSP48A1s	Clock Freq (Mhz)
8	245	267	298	8	234
10	285	299	341	8	234
12	325	327	377	8	234
16	405	425	484	8	242

1. Speedfile: XC7K70T FBG484

Table 2-8: Artix-7 (Zynq-7000 XC7Z030 and XC7Z045)

Data Width	Slice FFs	Slice LUTs	LUT6-FF pairs	DSP48A1s	Clock Freq (Mhz)
8	245	268	307	8	180
10	285	299	343	8	180
12	325	328	364	8	188
16	405	424	488	8	188

1. Speedfile: XC7A100T FGG484

## Core Interfaces and Register Space

### Port Descriptions

The YCrCb to RGB Color-Space Converter core uses industry standard control and data interfaces to connect to other system components. The following sections describe the various interfaces available with the core. [Figure 2-1](#) illustrates an I/O diagram of the YCrCb2RGB core. Some signals are optional and not present for all configurations of the core. The AXI4-Lite interface and the `IRQ` pin are present only when the core is configured via the GUI with an AXI4-Lite control interface. The `INTC_IF` interface is present only when the core is configured via the GUI with the INTC interface enabled.

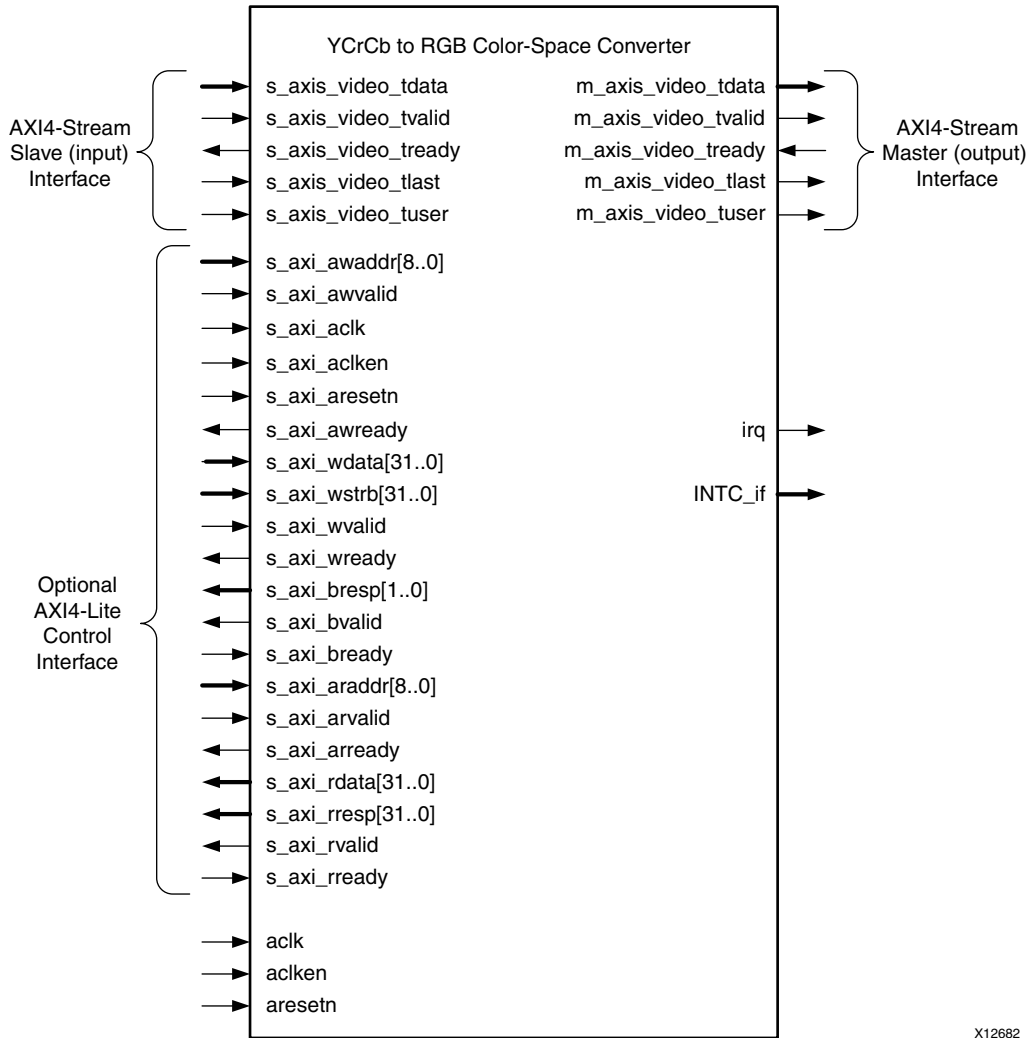

Figure 2-1: YCrCb2RGB Core Top-Level Signaling Interface

X12682

## Common Interface Signals

Table 2-9 summarizes the signals which are either shared by, or not part of the dedicated AXI4-Stream data or AXI4-Lite control interfaces.

Table 2-9: Common Interface Signals

Signal Name	Direction	Width	Description
ACLK	In	1	Video Core Clock
ACLKEN	In	1	Video Core Active High Clock Enable
ARESETn	In	1	Video Core Active Low Synchronous Reset
INTC_IF	Out	6	Optional External Interrupt Controller Interface. Available only when <code>INTC_IF</code> is selected on GUI.
IRQ	Out	1	Optional Interrupt Request Pin. Available only when AXI4-Lite interface is selected on GUI.

The `ACLK`, `ACLKEN` and `ARESETn` signals are shared between the core and the AXI4-Stream data interfaces. The AXI4-Lite control interface has its own set of clock, clock enable and reset pins: `S_AXI_ACLK`, `S_AXI_ACLKEN` and `S_AXI_ARESETn`. Refer to [The Interrupt Subsystem](#) for a description of the `INTC_IF` and `IRQ` pins.

## ACLK

The AXI4-Stream interface must be synchronous to the core clock signal `ACLK`. All AXI4-Stream interface input signals are sampled on the rising edge of `ACLK`. All AXI4-Stream output signal changes occur after the rising edge of `ACLK`. The AXI4-Lite interface is unaffected by the `ACLK` signal.

## ACLKEN

The `ACLKEN` pin is an active-high, synchronous clock-enable input pertaining to AXI4-Stream interfaces. Setting `ACLKEN` low (de-asserted) halts the operation of the core despite rising edges on the `ACLK` pin. Internal states are maintained, and output signal levels are held until `ACLKEN` is asserted again. When `ACLKEN` is de-asserted, core inputs are not sampled, except `ARESETn`, which supersedes `ACLKEN`. The AXI4-Lite interface is unaffected by the `ACLKEN` signal.

## ARESETn

The `ARESETn` pin is an active-low, synchronous reset input pertaining to only AXI4-Stream interfaces. `ARESETn` supersedes `ACLKEN`, and when set to 0, the core resets at the next rising edge of `ACLK` even if `ACLKEN` is de-asserted. The `ARESETn` signal must be synchronous to the `ACLK` and must be held low for a minimum of 32 clock cycles of the slowest clock. The AXI4-Lite interface is unaffected by the `ARESETn` signal.

## Data Interface

The YCrCb2RGB core receives and transmits data using AXI4-Stream interfaces that implement a video protocol as defined in the *Video IP: AXI Feature Adoption* section of the (UG761) *AXI Reference Guide* [Ref 10].

### AXI4-Stream Signal Names and Descriptions

[Table 2-10](#) describes the AXI4-Stream signal names and descriptions.

**Table 2-10: AXI4-Stream Data Interface Signal Descriptions**

Signal Name	Direction	Width	Description
<code>s_axis_video_tdata</code>	In	24,32,40,48	Input Video Data
<code>s_axis_video_tvalid</code>	In	1	Input Video Valid Signal
<code>s_axis_video_tready</code>	Out	1	Input Ready

Table 2-10: AXI4-Stream Data Interface Signal Descriptions

Signal Name	Direction	Width	Description
s_axis_video_tuser	In	1	Input Video Start Of Frame
s_axis_video_tlast	In	1	Input Video End Of Line
m_axis_video_tdata	Out	24,32,40,48	Output Video Data
m_axis_video_tvalid	Out	1	Output Valid
m_axis_video_tready	In	1	Output Ready
m_axis_video_tuser	Out	1	Output Video Start Of Frame
m_axis_video_tlast	Out	1	Output Video End Of Line

### Video Data

The AXI4-Stream interface specification restricts TDATA widths to integer multiples of 8 bits. Therefore, 10, 12, and 16 bit sensor data must be padded with zeros on the MSB to form Nx8 bit wide vector before connecting to s\_axis\_video\_tdata. Padding does not affect the size of the core.

For example, YCbCr data on the YCrCb2RGB input s\_axis\_video\_tdata is packed and padded to multiples of 8 bits as necessary, as seen in Figure 2-2. Zero padding the most significant bits only necessary for 10,12 and 16 bits wide data.

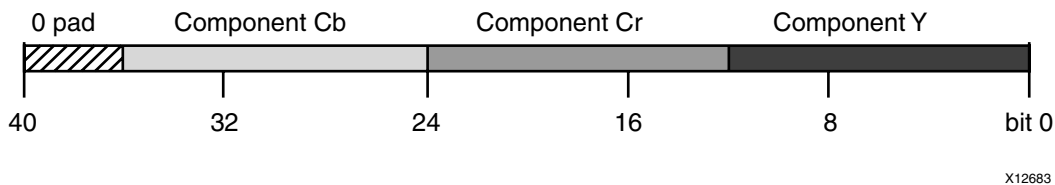

Figure 2-2: YCrCb Data Encoding on s\_axis\_video\_tdata

Similarly, RGB data on the YCrCb2RGB output m\_axis\_video\_tdata is packed and padded to multiples of 8 bits as necessary, as seen in Figure 2-3. Zero padding the most significant bits is only necessary for 10, 12, and 16 bit wide data.

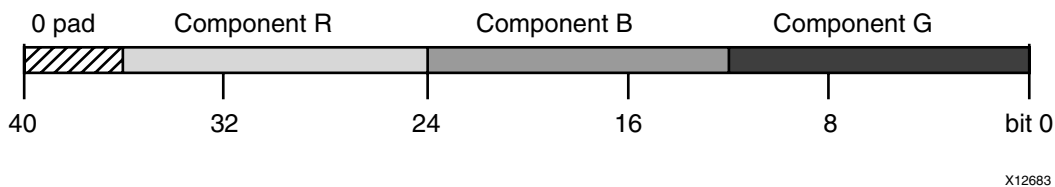

Figure 2-3: RGB Data Encoding on m\_axis\_video\_tdata

### READY/VALID Handshake

A valid transfer occurs whenever READY, VALID, ACLKEN, and ARESETn are high at the rising edge of ACLK, as seen in Figure 2-4. During valid transfers, DATA only carries active

video data. Blank periods and ancillary data packets are not transferred via the AXI4-Stream video protocol.

### Guidelines on Driving s\_axis\_video\_tvalid

Once s\_axis\_video\_tvalid is asserted, no interface signals (except the YCrCb2RGB core driving s\_axis\_video\_tready) may change value until the transaction completes (s\_axis\_video\_tready, s\_axis\_video\_tvalid ACLKEN high on the rising edge of ACLK). Once asserted, s\_axis\_video\_tvalid may only be de-asserted after a transaction has completed. Transactions may not be retracted or aborted. In any cycle following a transaction, s\_axis\_video\_tvalid can either be de-asserted or remain asserted to initiate a new transfer.

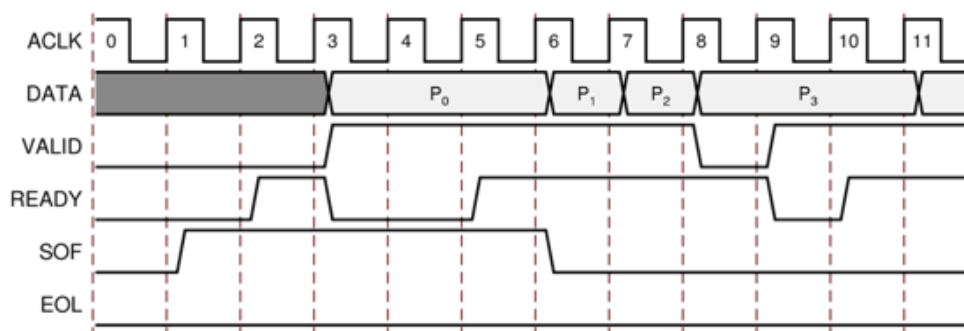

Figure 2-4: Example of READY/VALID Handshake, Start of a New Frame

### Guidelines on Driving m\_axis\_video\_tready

The m\_axis\_video\_tready signal may be asserted before, during or after the cycle in which the YCrCb2RGB core asserted m\_axis\_video\_tvalid. The assertion of m\_axis\_video\_tready may be dependent on the value of m\_axis\_video\_tvalid. A slave that can immediately accept data qualified by m\_axis\_video\_tvalid, should pre-assert its m\_axis\_video\_tready signal until data is received. Alternatively, m\_axis\_video\_tready can be registered and driven the cycle following VALID assertion. It is recommended that the AXI4-Stream slave should drive READY independently, or pre-assert READY to minimize latency.

### Start of Frame Signals - m\_axis\_video\_tuser0, s\_axis\_video\_tuser0

The Start-Of-Frame (SOF) signal, physically transmitted over the AXI4-Stream TUSER0 signal, marks the first pixel of a video frame. The SOF pulse is 1 valid transaction wide, and must coincide with the first pixel of the frame, as seen in Figure 2-4. SOF serves as a frame synchronization signal, which allows downstream cores to re-initialize, and detect the first pixel of a frame. The SOF signal may be asserted an arbitrary number of ACLK cycles before the first pixel value is presented on DATA, as long as a VALID is not asserted.



## End of Line Signals - `m_axis_video_tlast`, `s_axis_video_tlast`

The End-Of-Line signal, physically transmitted over the AXI4-Stream TLAST signal, marks the last pixel of a line. The EOL pulse is 1 valid transaction wide, and must coincide with the last pixel of a scan-line, as seen in Figure 2-5.

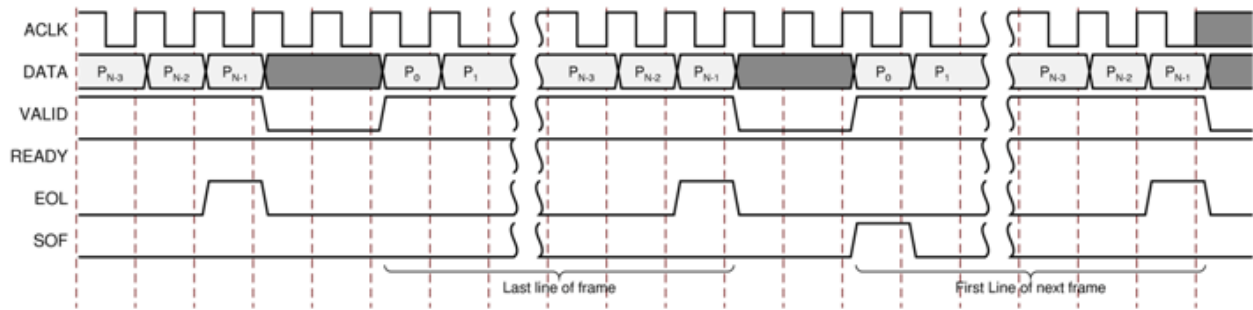

Figure 2-5: Use of EOL and SOF Signals

## Control Interface

When configuring the core, the user has the option to add an AXI4-Lite register interface to dynamically control the behavior of the core. The AXI4-Lite slave interface facilitates integrating the core into a processor system, or along with other video or AXI4-Lite compliant IP, connected via AXI4-Lite interface to an AXI4-Lite master. In a static configuration with a fixed set of parameters (constant configuration), the core can be instantiated without the AXI4-Lite control interface, which reduces the core Slice footprint.

## Constant Configuration

The constant configuration caters to users who will use the core in one setup that will not need to change over time. In constant configuration the image resolution (number of active pixels per scan line and the number of active scan lines per frame), and the other core parameters are hard coded into the core via the YCrCb2RGB core GUI. Since there is no AXI4-Lite interface, the core is not programmable, but can be reset, enabled, or disabled using the `ARESETn` and `ACLKEN` ports.

## AXI4-Lite Interface

The AXI4-Lite interface allows a user to dynamically control parameters within the core. Core configuration can be accomplished using an AXI4-Stream master state machine, or an embedded ARM or soft system processor such as MicroBlaze.

The YCrCb2RGB core can be controlled via the AXI4-Lite interface using read and write transactions to the YCrCb2RGB register space.

Table 2-11: AXI4-Lite Interface Signals

Signal Name	Direction	Width	Description
s_axi_aclk	In	1	AXI4-Lite clock
s_axi_aclken	In	1	AXI4-Lite clock enable
s_axi_aresetn	In	1	AXI4-Lite synchronous Active Low reset
s_axi_awvalid	In	1	AXI4-Lite Write Address Channel Write Address Valid.
s_axi_awread	Out	1	AXI4-Lite Write Address Channel Write Address Ready. Indicates DMA ready to accept the write address.
s_axi_awaddr	In	32	AXI4-Lite Write Address Bus
s_axi_wvalid	In	1	AXI4-Lite Write Data Channel Write Data Valid.
s_axi_wready	Out	1	AXI4-Lite Write Data Channel Write Data Ready. Indicates DMA is ready to accept the write data.
s_axi_wdata	In	32	AXI4-Lite Write Data Bus
s_axi_bresp	Out	2	AXI4-Lite Write Response Channel. Indicates results of the write transfer.
s_axi_bvalid	Out	1	AXI4-Lite Write Response Channel Response Valid. Indicates response is valid.
s_axi_bready	In	1	AXI4-Lite Write Response Channel Ready. Indicates target is ready to receive response.
s_axi_arvalid	In	1	AXI4-Lite Read Address Channel Read Address Valid
s_axi_arready	Out	1	Ready. Indicates DMA is ready to accept the read address.
s_axi_araddr	In	32	AXI4-Lite Read Address Bus
s_axi_rvalid	Out	1	AXI4-Lite Read Data Channel Read Data Valid
s_axi_rready	In	1	AXI4-Lite Read Data Channel Read Data Ready. Indicates target is ready to accept the read data.
s_axi_rdata	Out	32	AXI4-Lite Read Data Bus
s_axi_rresp	Out	2	AXI4-Lite Read Response Channel Response. Indicates results of the read transfer.

## S\_AXI\_ACLK

The AXI4-Lite interface must be synchronous to the S\_AXI\_ACLK clock signal. The AXI4-Lite interface input signals are sampled on the rising edge of ACLK. The AXI4-Lite output signal changes occur after the rising edge of ACLK. The AXI4-Stream interfaces signals are not affected by the S\_AXI\_ACLK.

## S\_AXI\_ACLKEN

The S\_AXI\_ACLKEN pin is an active-high, synchronous clock-enable input for the AXI4-Lite interface. Setting S\_AXI\_ACLKEN low (de-asserted) halts the operation of the AXI4-Lite interface despite rising edges on the S\_AXI\_ACLK pin. AXI4-Lite interface states are maintained, and AXI4-Lite interface output signal levels are held until S\_AXI\_ACLKEN is

asserted again. When `S_AXI_ACLKEN` is de-asserted, AXI4-Lite interface inputs are not sampled, except `S_AXI_ARESETn`, which supersedes `S_AXI_ACLKEN`. The AXI4-Stream interfaces signals are not affected by the `S_AXI_ACLKEN`.

## S\_AXI\_ARESETn

The `S_AXI_ARESETn` pin is an active-low, synchronous reset input for the AXI4-Lite interface. `S_AXI_ARESETn` supersedes `S_AXI_ACLKEN`, and when set to 0, the core resets at the next rising edge of `S_AXI_ACLK` even if `S_AXI_ACLKEN` is de-asserted. The `S_AXI_ARESETn` signal must be synchronous to the `S_AXI_ACLK` and must be held low for a minimum of 32 clock cycles of the slowest clock. The `S_AXI_ARESETn` input is resynchronized to the `ACLK` clock domain. The AXI4-Stream interfaces and core signals are also reset by `S_AXI_ARESETn`.

## Register Space

The standardized Xilinx Video IP register space is partitioned to control-, timing-, and core specific registers. The YCrCb2RGB core uses only one timing related register, `ACTIVE_SIZE` (0x0020), which allows specifying the input frame dimensions. The core has nine core specific registers that control Matrix coefficients, the data offsets and the clip and clamp values.

**Table 2-12: Register Names and Descriptions**

Address (hex) BASEADDR +	Register Name	Access Type	Double Buffered	Default Value	Register Description
0x0000	CONTROL	R/W	N	No AXI4-Lite IF: 0x1 Power-on-Reset : 0x0	Bit 0: SW_ENABLE Bit 1: REG_UPDATE Bit 4: BYPASS <sup>(1)</sup> Bit 5: TEST_PATTERN <sup>(1)</sup> Bit 30: FRAME_SYNC_RESET (1: reset) Bit 31: SW_RESET (1: reset)
0x0004	STATUS	R/W	No	0	Bit 0: PROC_STARTED Bit 1: EOF Bit 16: SLAVE_ERROR
0x0008	ERROR	R/W	No	0	Bit 0: SLAVE_EOL_EARLY Bit 1: SLAVE_EOL_LATE Bit 2: SLAVE_SOF_EARLY Bit 3: SLAVE_SOF_LATE
0x000C	IRQ_ENABLE	R/W	No	0	16-0: Interrupt enable bits corresponding to STATUS bits

Table 2-12: Register Names and Descriptions

Address (hex) BASEADDR +	Register Name	Access Type	Double Buffered	Default Value	Register Description
0x0010	VERSION	R	N/A	0x0601a000	7-0: REVISION_NUMBER 11-8: PATCH_ID 15-12: VERSION_REVISION 23-16: VERSION_MINOR 31-24: VERSION_MAJOR
0x0014	SYSDEBUG0	R	N/A	0	0-31: Frame Throughput monitor <sup>(1)</sup>
0x0018	SYSDEBUG1	R	N/A	0	0-31: Line Throughput monitor <sup>(1)</sup>
0x001C	SYSDEBUG2	R	N/A	0	0-31: Pixel Throughput monitor <sup>(1)</sup>
0x0020	ACTIVE_SIZE	R/W	Yes	Specified via GUI	12-0: Number of Active Pixels per Scanline 28-16: Number of Active Lines per Frame
0x0100	RGBMAX	R/W	Yes	Specified via GUI	15:0: RGB clipping value
0x0104	RGBMIN	R/W	Yes	Specified via GUI	15:0: RGB clamping value
0x0108	ROFFSET	R/W	Yes	Specified via GUI	31:0: Red offset compensation
0x010C	GOFFSET	R/W	Yes	Specified via GUI	31:0: Green offset compensation
0x0110	BOFFSET	R/W	Yes	Specified via GUI	31:0: Blue offset compensation
0x0114	ACOEf	R/W	Yes	Specified via GUI	17:0: ACOEF, BCOEF, CCOEF, DCOEF are derived from CA, CB, CC and CD, by calculating the inverse multiplication matrix and representing as a 17-bit fixed point number.
0x0118	BCOEf	R/W	Yes	Specified via GUI	
0x011C	CCOEf	R/W	Yes	Specified via GUI	
0x0120	DCOEf	R/W	Yes	Specified via GUI	

1. Only available when the debugging features option is enabled in the GUI at the time the core is instantiated.

## CONTROL (0x0000) Register

Bit 0 of the CONTROL register, SW\_ENABLE, facilitates enabling and disabling the core from software. Writing '0' to this bit effectively disables the core halting further operations, which blocks the propagation of all video signals. The default value of SW enable is 1 (enabled) for the Constant configuration. After Power up, or Global Reset, the SW\_ENABLE defaults to 0 for the AXI4-Lite interface. Similar to the ACLKEN pin, the SW\_ENABLE flag is not synchronized with the AXI4-Stream interfaces: Enabling or Disabling the core takes effect immediately, irrespective of the core processing status. Disabling the core for extended periods may lead to image tearing.

Bit 1 of the CONTROL register, REG\_UPDATE is a write done semaphore for the host processor, which facilitates committing all user and timing register updates simultaneously. The YCrCb2RGB core ACTIVE\_SIZE and core specific registers are double buffered. One set of registers (the processor registers) is directly accessed by the processor interface,

while the other set (the active set) is actively used by the core. New values written to the processor registers will get copied over to the active set at the end of the AXI4-Stream frame, if and only if `REG_UPDATE` is set. Setting `REG_UPDATE` to 0 before updating multiple register values, then setting `REG_UPDATE` to 1 when updates are completed ensures all registers are updated simultaneously at the frame boundary without causing image tearing.

Bit 4 of the `CONTROL` register, `BYPASS`, switches the core to bypass mode if debug features are enabled. In bypass mode the YCrCb2RGB core processing function is bypassed, and the core repeats AXI4-Stream input samples on its output. Refer to [Debugging Features in Appendix C](#) for more information. If debug features were not included at instantiation, this flag has no effect on the operation of the core. Switching bypass mode on or off is not synchronized to frame processing, therefore can lead to image tearing.

Bit 5 of the `CONTROL` register, `TEST_PATTERN`, switches the core to test-pattern generator mode if debug features are enabled. Refer to [Debugging Features in Appendix C](#) for more information. If debug features were not included at instantiation, this flag has no effect on the operation of the core. Switching test-pattern generator mode on or off is not synchronized to frame processing, therefore can lead to image tearing.

Bits 30 and 31 of the `CONTROL` register, `FRAME_SYNC_RESET` and `SW_RESET` facilitate software reset. Setting `SW_RESET` reinitializes the core to GUI default values, all internal registers and outputs are cleared and held at initial values until `SW_RESET` is set to 0. The `SW_RESET` flag is not synchronized with the AXI4-Stream interfaces. Resetting the core while frame processing is progress will cause image tearing. For applications where the soft-ware reset functionality is desirable, but image tearing has to be avoided a frame synchronized software reset (`FRAME_SYNC_RESET`) is available. Setting `FRAME_SYNC_RESET` to 1 will reset the core at the end of the frame being processed, or immediately if the core is between frames when the `FRAME_SYNC_RESET` was asserted. After reset, the `FRAME_SYNC_RESET` bit is automatically cleared, so the core can get ready to process the next frame of video as soon as possible. The default value of both `RESET` bits is 0. Core instances with no AXI4-Lite control interface can only be reset via the `ARESETn` pin.

## STATUS (0x0004) Register

All bits of the `STATUS` register can be used to request an interrupt from the host processor. To facilitate identification of the interrupt source, bits of the `STATUS` register remain set after an event associated with the particular `STATUS` register bit, even if the event condition is not present at the time the interrupt is serviced.

Bits of the `STATUS` register can be cleared individually by writing '1' to the bit position.

Bit 0 of the `STATUS` register, `PROC_STARTED`, indicates that processing of a frame has commenced via the AXI4-Stream interface.

Bit 1 of the `STATUS` register, End-of-frame (EOF), indicates that the processing of a frame has completed.

Bit 16 of the `STATUS` register, `SLAVE_ERROR`, indicates that one of the conditions monitored by the `ERROR` register has occurred.

### ERROR (0x0008) Register

Bit 4 of the `STATUS` register, `SLAVE_ERROR`, indicates that one of the conditions monitored by the `ERROR` register has occurred. This bit can be used to request an interrupt from the host processor. To facilitate identification of the interrupt source, bits of the `STATUS` and `ERROR` registers remain set after an event associated with the particular `ERROR` register bit, even if the event condition is not present at the time the interrupt is serviced.

Bits of the `ERROR` register can be inverted individually by writing '1' to the bit position to be cleared.

Bit 0 of the `ERROR` register, `EOL_EARLY`, indicates an error during processing a video frame via the AXI4-Stream slave port. The number of pixels received between the latest and the preceding End-Of-Line (EOL) signal was less than the value programmed into the `ACTIVE_SIZE` register.

Bit 1 of the `ERROR` register, `EOL_LATE`, indicates an error during processing a video frame via the AXI4-Stream slave port. The number of pixels received between the last EOL signal surpassed the value programmed into the `ACTIVE_SIZE` register.

Bit 2 of the `ERROR` register, `SOF_EARLY`, indicates an error during processing a video frame via the AXI4-Stream slave port. The number of pixels received between the latest and the preceding Start-Of-Frame (SOF) signal was less than the value programmed into the `ACTIVE_SIZE` register.

Bit 3 of the `ERROR` register, `SOF_LATE`, indicates an error during processing a video frame via the AXI4-Stream slave port. The number of pixels received between the last SOF signal surpassed the value programmed into the `ACTIVE_SIZE` register.

### IRQ\_ENABLE (0x000C) Register

Any bits of the `STATUS` register can generate a host-processor interrupt request via the `IRQ` pin. The Interrupt Enable register facilitates selecting which bits of `STATUS` register will assert `IRQ`. Bits of the `STATUS` registers are masked by (AND) corresponding bits of the `IRQ_ENABLE` register and the resulting terms are combined (OR) together to generate `IRQ`.

### Version (0x0010) Register

Bit fields of the Version Register facilitate software identification of the exact version of the hardware peripheral incorporated into a system. The core driver can take advantage of this Read-Only value to verify that the software is matched to the correct version of the hardware. See [Table 2-12](#) for more information.

### **SYSDEBUG0 (0x0014) Register**

The `SYSDEBUG0`, or Frame Throughput Monitor, register indicates the number of frames processed since power-up or the last time the core was reset. The `SYSDEBUG` registers can be useful to identify external memory / Frame buffer / or throughput bottlenecks in a video system. Refer to [Debugging Features in Appendix C](#) for more information.

### **SYSDEBUG1 (0x0018) Register**

The `SYSDEBUG1`, or Line Throughput Monitor, register indicates the number of lines processed since power-up or the last time the core was reset. The `SYSDEBUG` registers can be useful to identify external memory / Frame buffer / or throughput bottlenecks in a video system. Refer to [Debugging Features in Appendix C](#) for more information.

### **SYSDEBUG2 (0x001C) Register**

The `SYSDEBUG2`, or Pixel Throughput Monitor, register indicates the number of pixels processed since power-up or the last time the core was reset. The `SYSDEBUG` registers can be useful to identify external memory / Frame buffer / or throughput bottlenecks in a video system. Refer to [Debugging Features in Appendix C](#) for more information.

### **ACTIVE\_SIZE (0x0020) Register**

The `ACTIVE_SIZE` register encodes the number of active pixels per scan line and the number of active scan lines per frame. The lower half-word (bits 12:0) encodes the number of active pixels per scan line. Supported values are between 32 and the value provided in the **Maximum number of pixels per scan line** field in the GUI. The upper half-word (bits 28:16) encodes the number of active scan lines per frame. Supported values are 32 to 7680. To avoid processing errors, the user should restrict values written to `ACTIVE_SIZE` the range supported by the core instance.

### **RGBMAX (0x0100) Register**

The `RGBMAX` register holds the maximum value allowed on the Red, Green and Blue channels of the output. If the output data is greater than this value, then this value replaces it on the output. This register is only valid if "Outputs Clipped" is selected in the core parameterization GUI.

### **RGBMIN (0x0104) Register**

The `YMin` register holds the minimum value allowed on the Red, Green and Blue channels of the output. If the output data is less than this value, then this value replaces it on the output. This register is only valid if "Outputs Clamped" is selected in the core parameterization GUI.



**ROFFSET (0x0108) Register**

The ROFFSET register holds the offset compensation value for the Red channel.

**GOFFSET(0x010C) Register**

The GOFFSET register holds the offset compensation value for the Green channel.

**BOFFSET (0x0110) Register**

The BOFFSET register holds the offset compensation value for the Blue channel.

**ACOEf (0x0114) Register**

The ACOEF register holds the transformed CA coefficient expressed as an 18.16 floating point number.

**BCOEf (0x0118) Register**

The BCOEF register holds the transformed CB coefficient expressed as an 18.16 floating point number.

**CCOEf (0x011C) Register**

The CCOEF register holds the transformed CC coefficient expressed as an 18.16 floating point number.

**DCOEf (0x0120) Register**

The DCOEF register holds the transformed CD coefficient expressed as an 18.16 floating point number.

**The Interrupt Subsystem**

STATUS register bits can trigger interrupts so embedded application developers can quickly identify faulty inter-faces or incorrectly parameterized cores in a video system. Irrespective of whether the AXI4-Lite control interface is present or not, the YCrCb2RGB core detects AXI4-Stream framing errors, as well as the beginning and the end of frame processing.

When the core is instantiated with an AXI4-Lite Control interface, the optional interrupt request pin (IRQ) is present. Events associated with bits of the STATUS register can generate a (level triggered) interrupt, if the corresponding bits of the interrupt enable register (IRQ\_ENABLE) are set. Once set by the corresponding event, bits of the STATUS register stay set until the user application clears them by writing '1' to the desired bit



positions. Using this mechanism the system processor can identify and clear the interrupt source.

Without the AXI4-Lite interface the user can still benefit from the core signaling error and status events. By selecting the **Enable INTC Port** check-box on the GUI, the core generates the optional `INTC_IF` port. This vector of signals gives parallel access to the individual interrupt sources, as seen in [Table 2-13](#).

Unlike `STATUS` and `ERROR` flags, `INTC_IF` signals are not held, rather stay asserted only while the corresponding event persists.

*Table 2-13: INTC\_IF Signal Functions*

INTC_IF signal	Function
0	Frame processing start
1	Frame processing complete
2	Reserved
3	Reserved
4	Video over AXI4-Stream Error
5	EOL Early
6	EOL Late
7	SOF Early
8	SOF Late

In a system integration tool, such as EDK, the interrupt controller INTC IP can be used to register the selected `INTC_IF` signals as edge triggered interrupt sources. The INTC IP provides functionality to mask (enable or disable), as well as identify individual interrupt sources from software. Alternatively, for an external processor or MCU the user can custom build a priority interrupt controller to aggregate interrupt requests and identify interrupt sources.

# Designing with the Core

## General Design Guidelines

The YCrCb2RGB core converts YCrCb 4:4:4 (or YUV 4:4:4) video data into RGB video data. The core processes samples provided via an AXI4-Stream slave interface, outputs pixels via an AXI4-Stream master interface, and can be controlled via an optional AXI4-Lite interface. The YCrCb2RGB block cannot change the input/output image sizes, the input and output pixel clock rates, or the frame rate. It is recommended that the YCrCb2RGB core is used in conjunction with the Video In to AXI4-Stream and Video Timing Controller cores. The Video Timing Controller core measures the timing parameters, such as number of active scan lines, number of active pixels per scan line of the image sensor. The Video In to AXI4-Stream core converts a standard parallel clocked video interface with syncs and or blanks to AXI4-Stream Video protocol as defined in the *Video IP: AXI Feature Adoption* section of the (UG761) *AXI Reference Guide* [Ref 10].

Typically, the YCrCb2RGB core is part of a larger video system such as an Image Sensor Pipeline (ISP) System shown in Figure 3-1.

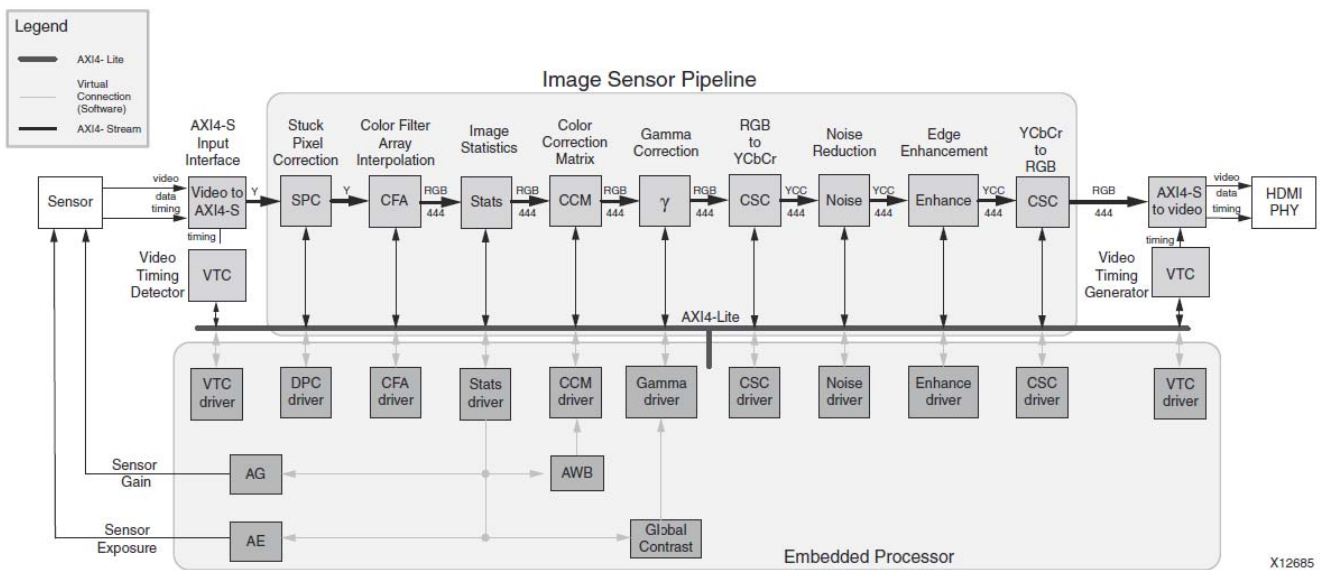

Figure 3-1: Image Sensor Pipeline System with YCrCb2RGB Core

# Color-Space Conversion Background

## RGB Color Space

The red, green and blue (RGB) color space is widely used throughout computer graphics. Red, green and blue are three primary additive colors: individual components are added together to form a desired color, and are represented by a three dimensional, Cartesian coordinate system, as shown in [Figure 3-2](#).

[Table 3-1](#) presents the RGB values for 100% saturated color bars, a common video test signal.

*Table 3-1: 100% RGB Color Bars*

	Normal Range	White	Yellow	Cyan	Green	Magenta	Red	Blue	Black
<b>R</b>	0 to 255	255	255	0	0	255	255	0	0
<b>G</b>	0 to 255	255	255	255	255	0	0	0	0
<b>B</b>	0 to 255	255	0	255	0	255	0	255	0

The RGB color space is the most prevalent choice for computer graphics because color displays use red, green and blue to create the desired color. Also, a system that is designed using the RGB color space can take advantage of a large number of existing software algorithms.

However, RGB is not very efficient when dealing with real-world images. All three components need equal bandwidth to generate arbitrary colors within the RGB color cube. Also, processing an image in the RGB color space is usually not the most efficient method. For example, to modify the intensity or color of a given pixel, all three RGB values must be read, modified and written back to the frame buffer. If the system had access to the image stored in the intensity and color format, the process would be faster.

## R'G'B' Color Space

While the RGB color space is ideal to represent computer graphics, 8-bit linear-light coding performs poorly for images to be viewed [\[Ref 2\]](#). It is necessary to have 12 or 14 bits per component to achieve excellent quality. The best perceptual use is made of a limited number of bits by using nonlinear coding that mimics the nonlinear response of human vision. In video, JPEG, MPEG, computing, digital photography, and many other domains, a nonlinear transfer function is applied to the RGB signals to give nonlinearly coded gamma-corrected components, denoted with symbols R'G'B'. Excellent image quality can be obtained with 10-bit nonlinear coding with a transfer function similar to that of *Rec. 709* [\[Ref 4\]](#) or RGB.

## YUV Color Space

The YUV color space is used by the analog PAL, NTSC and SECAM color video/TV standards. In the past, black and white systems used only the luminance (Y) information. Chrominance information (U and V) was added in such a way that a black and white receiver can still display a normal black and white picture.

## YCrCb (or YCbCr) Color Space

The YCrCb or YCbCr color space was developed as part of the *ITU-R BT.601* [Ref 3] during the development of a world-wide digital component video standard. YCbCr is a scaled, offset version of the YUV color space. Y has a nominal range of 16-235; Cb and Cr have a nominal range of 16-240. There are several YCbCr sampling formats, such as 4:4:4, 4:2:2 and 4:2:0.

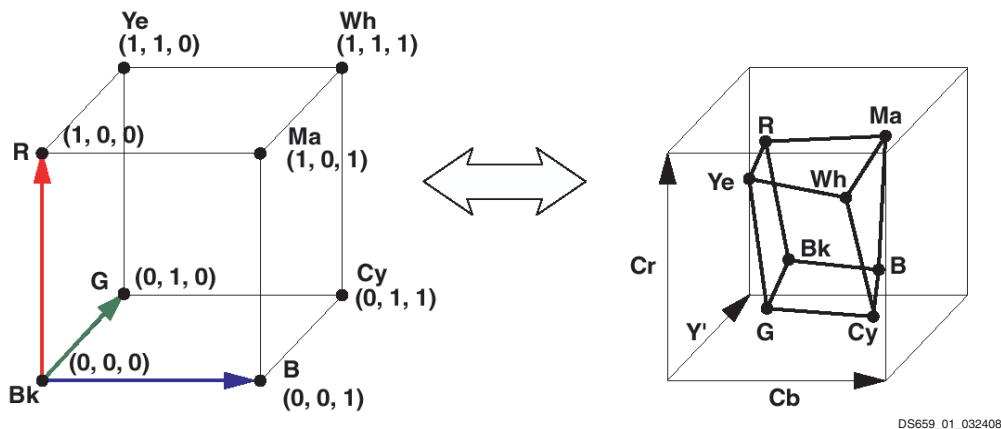

Figure 3-2: RGB and YCrCb Color Representations

## Conversion Equations

### Derivation of Conversion Equations

To generate the luminance (Y, or gray value) component, biometric experiments were employed to measure how the human eye perceives the intensities of the red, green and blue colors. Based on these experiments, optimal values for coefficients CA and CB were determined, such that:

$$Y = CA * R + (1 - CA - CB) * G + CB * B \tag{Equation 3-1}$$

Actual values for CA and CB differ slightly in different standards.

Conversion from the RGB color space to luminance and chrominance (differential color components) could be described with the following equation:

$$\begin{bmatrix} Y \\ R-Y \\ B-Y \end{bmatrix} = \begin{bmatrix} CA & 1-CA-CB & CB \\ 1-CA & CA+CB-1 & -CB \\ -CA & CA+CB-1 & 1-CB \end{bmatrix} \begin{bmatrix} R \\ G \\ B \end{bmatrix} \quad \text{Equation 3-2}$$

Coefficients CA and CB are chosen between 0 and 1, which guarantees that the range of Y is constrained between the maximum and the minimum RGB values permitted,  $RGB_{max}$  and  $RGB_{min}$  respectively.

In most practical implementations, the range of the luminance and chrominance components should be equal. There are two ways to accomplish this: the chrominance components (B-Y and R-Y) can be normalized (compressed and offset compensated), or values above and below the luminance range can be clipped/clamped.

Both clipping and dynamic range compression results in loss of information; however, the introduced artifacts are different. To leverage differences in the input (RGB) range, different standards choose different tradeoffs between clipping and normalization.

The YCrCb to RGB Color-Space Converter core supports only the conversions that fit the following general form:

$$\begin{bmatrix} Y \\ C_R \\ C_B \end{bmatrix} = \begin{bmatrix} CA & 1-CA-CB & CB \\ CC(1-CA) & CC(CA+CB-1) & CC(-CB) \\ CD(-CA) & CD(CA+CB-1) & CD(1-CB) \end{bmatrix} \begin{bmatrix} R \\ G \\ B \end{bmatrix} + \begin{bmatrix} O_Y \\ O_{Cr} \\ O_{Cb} \end{bmatrix} \quad \text{Equation 3-3}$$

CC and CD allow dynamic range compression for B-Y and R-Y, and constants  $O_Y$  and  $O_C$  facilitate offset compensation for the resulting CB and CR. To avoid arithmetic under- and overflows while converting from the RGB to the YCrCb domain, with RGB values in the [0.1] range, a choice for CC and CD is:

$$CC = \frac{1}{2(1-CA)} \quad CD = \frac{1}{2(1-CB)} \quad \text{Equation 3-4}$$

The YCrCb to RGB core facilitates both range de-compression and optional clipping and clamping. Range, offset, clipping and clamping levels are parameterizable.

By inverting the transformation matrix in Equation 3-3, the transformation from the YCrCb color space to the RGB color space can be defined as:

$$\begin{bmatrix} R \\ G \\ B \end{bmatrix} = \begin{bmatrix} 1 & 1/CC & 0 \\ 1 & \frac{-CA}{CC(1-CA-CB)} & \frac{-CB}{CD(1-CA-CB)} \\ 1 & 0 & 1/CD \end{bmatrix} \begin{bmatrix} Y-O_Y \\ C_R-O_{Cr} \\ C_B-O_{Cb} \end{bmatrix} \quad \text{Equation 3-5}$$

### Hardware Implementation

The YCrCb to RGB color-space transformation (Equation 3-5) can be expressed as:

$$R = Y - O_Y + ACOEF(C_R - O_{Cr}) \quad \text{Equation 3-6}$$

$$G = Y - O_Y + BCOEF(C_R - O_{Cr}) + CCOEF(C_B - O_{Cb}) \quad \text{Equation 3-7}$$

$$B = Y - O_Y + DCOEF(C_B - O_{Cb}) \quad \text{Equation 3-8}$$

This cannot efficiently utilize the MADD capabilities of XtremeDSP slices. As offsets and coefficients are constants, the preceding equations can be rewritten as:

$$R = ACOEF \cdot C_R + ROFFSET + Y \quad \text{Equation 3-9}$$

$$G = BCOEF \cdot C_R + CCOEF \cdot C_B + GOFFSET + Y \quad \text{Equation 3-10}$$

$$B = DCOEF \cdot C_B + BOFFSET + Y \quad \text{Equation 3-11}$$

This can be directly mapped to the architecture shown in Figure 3-3. The blue and gray boxes represent logic blocks, which are always implemented using XtremeDSP slices.

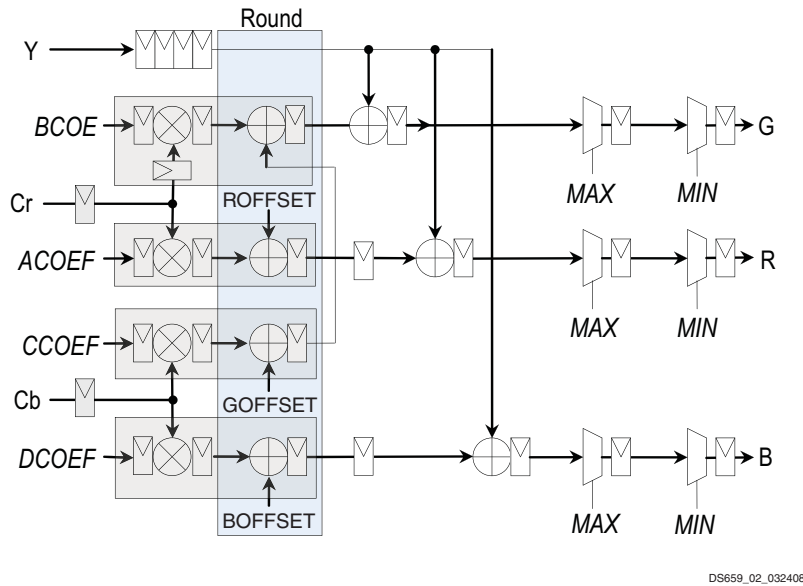

Figure 3-3: YcrCb to RGB Schematic

### Assigning Values to Design Parameters

The following section specifies parameter values for some widely used standards. Most parameter values, except for COEF and OFFSET parameters, can be assigned from Table 3-2, Table 3-3 and Table 3-4 directly. These parameters have to be calculated, scaled and rounded before assigning integer values to corresponding VHDL parameters, using the following equations:

$$ACOEF = \frac{1}{CC} \quad \text{Equation 3-12}$$

$$BCOEF = \frac{-CA}{CC(1 - CA - CB)} \quad \text{Equation 3-13}$$

$$CCOEF = \frac{-CB}{CD(1 - CA - CB)} \quad \text{Equation 3-14}$$

$$DCOEF = \frac{1}{CD} \quad \text{Equation 3-15}$$

Coefficients are passed to the core in 17 bits wide two's complement format. Y, Cr and Cb are passed as DATA\_WIDTH bits wide unsigned integers. MWIDTH is preset to Min(32, DATA\_WIDTH+17).

$$\text{ROUNDING\_CONST} = 2^{\text{MWIDTH} - \text{DATA\_WIDTH}} \quad \text{Equation 3-16}$$

$$\text{ROFFSET} = \text{ROUNDING\_CONST} - (\text{ACOE}F \bullet \text{CROFFSET} + \text{YOFFSET}) \bullet \text{SCALE\_M} \quad \text{Equation 3-17}$$

$$\text{GOFFSET} = \text{ROUNDING\_CONST} - ((\text{BOEF} + \text{CROFFSET}) + (\text{CCOE}F \times \text{CBOFFSET}) + \text{YOFFSET}) \bullet \text{SCALE\_M} \quad \text{Equation 3-18}$$

$$\text{BOFFSET} = \text{ROUNDING\_CONST} - (\text{DCOE}F \bullet \text{CBOFFSET} + \text{YOFFSET}) \bullet \text{SCALE\_M} \quad \text{Equation 3-19}$$

$$\text{SCALE\_M} = 2^{\text{MWIDTH} - \text{IWIDTH} - 17} \quad \text{Equation 3-20}$$

### ITU 601 (SD) and 709 - 1125/60 (NTSC) Standard Conversion Coefficients

Table 3-2: Parameterization Values for the SD (ITU 601) and NTSC HD (ITU 709) Standards

Coefficient/ Parameter	Range		
	16-240	16-235	0-255
CA	0.299		0.2568
CB	0.114		0.0979
CC	0.713	0.7295	0.5910
CD	0.564	0.5772	
YOFFSET	$2^{\text{DATA\_WIDTH}-4}$		
CB/CR	$2^{\text{DATA\_WIDTH}-1}$		
YMAX	$240 \times 2^{\text{DATA\_WIDTH}-8}$	$235 \times 2^{\text{DATA\_WIDTH}-8}$	$2^{\text{DATA\_WIDTH}-1}$
CMAX	$240 \times 2^{\text{DATA\_WIDTH}-8}$	$235 \times 2^{\text{DATA\_WIDTH}-8}$	$2^{\text{DATA\_WIDTH}-1}$
YMIN	$16 \times 2^{\text{DATA\_WIDTH}-8}$		0
CMIN	$16 \times 2^{\text{DATA\_WIDTH}-8}$		0

### Standard ITU 709 (HD) 1250/50 (PAL)

Table 3-3: Parameterization Values for the PAL HD (ITU 709) Standard

Coefficient/ Parameter	Input range		
	16-240	16-235	0-255
CA	0.2126		0.1819
CB	0.0722		0.0618
CC	0.6350	0.6495	0.6495

Table 3-3: Parameterization Values for the PAL HD (ITU 709) Standard (Cont'd)

Coefficient/ Parameter	Input range		
	16-240	16-235	0-255
CD	0.5389	0.5512	
YOFFSET	$2^{DATA\_WIDTH-4}$		
COFFSET	$2^{DATA\_WIDTH-1}$		
YMAX	$240 * 2^{DATA\_WIDTH-8}$	$235 * 2^{DATA\_WIDTH-8}$	$2^{DATA\_WIDTH-1}$
CMAX	$240 * 2^{DATA\_WIDTH-8}$	$235 * 2^{DATA\_WIDTH-8}$	$2^{DATA\_WIDTH-1}$
YMIN	$16 * 2^{DATA\_WIDTH-8}$		0
CMIN	$16 * 2^{DATA\_WIDTH-8}$		0

## YUV Standard

Table 3-4: Parameterization Values for the YUV Standard

Coefficient/ Parameter	Value		
	16-240	16-235	0-255
CA	0.299		
CB	0.114		
CC	0.877283		
CD	0.492111		
YOFFSET	$2^{DATA\_WIDTH-4}$		
COFFSET	$2^{DATA\_WIDTH-1}$		
YMAX	$240 * 2^{DATA\_WIDTH-8}$	$235 * 2^{DATA\_WIDTH-8}$	$2^{DATA\_WIDTH-1}$
CMAX	$240 * 2^{DATA\_WIDTH-8}$	$235 * 2^{DATA\_WIDTH-8}$	$2^{DATA\_WIDTH-1}$
YMIN	$16 * 2^{DATA\_WIDTH-8}$		0
CMIN	$16 * 2^{DATA\_WIDTH-8}$		0

## Clipping and Clamping

### Output Quantization Noise

Coefficients CC and CD in Equation 3-3 allow standard designers to trade off output quantization and clipping noise. Actual noise inserted depends on the probability statistics of the Cb and Cr variables, but in general if CC and CD are larger than the maximum values calculated in Equation 3-4, output values may clip, introducing clipping noise. However, the lower CC and CD values are chosen, the worse Cb and Cr values will use the available dynamic range, thus introducing more quantization noise. Therefore, the designer's task is to equalize output quantization and clipping noise insertion by carefully choosing CC and CD values based on knowing the statistics of Cb and Cr values. For instance, when



probabilities of extreme chrominance values are small, it is beneficial to increase CC and CD values, as the extra noise inserted by occasional clipping is less than the gain in average signal power (and thus SQNR).

## Output Clipping Noise

If coefficients CC and CD in Equation 3-3 are larger than the maximum values calculated in Equation 3-4, Cr and Cb output values may get larger (overflow) than the maximum or smaller (underflow) than minimum value the output representation can carry. If overflow occurs and the design does not have clipping logic, binary values wrap around and insert substantial noise to the output. If clamping/clipping logic is used, output values saturate and less noise is introduced, as shown in Figure 3-4. Use of clipping and clamping increases slice count of the design by approximately  $6 \cdot \text{DATA\_WIDTH}$  slices.

If a targeted standard limits output of values to a predefined range other than those of binary representation, such as *ITU-R BT.601-5* [Ref 3], use of clipping and clamping logic facilitates constraining output values to the predefined range by setting  $\text{RGB}_{\text{max}}$  and  $\text{RGB}_{\text{min}}$  values according to the standard specifications.

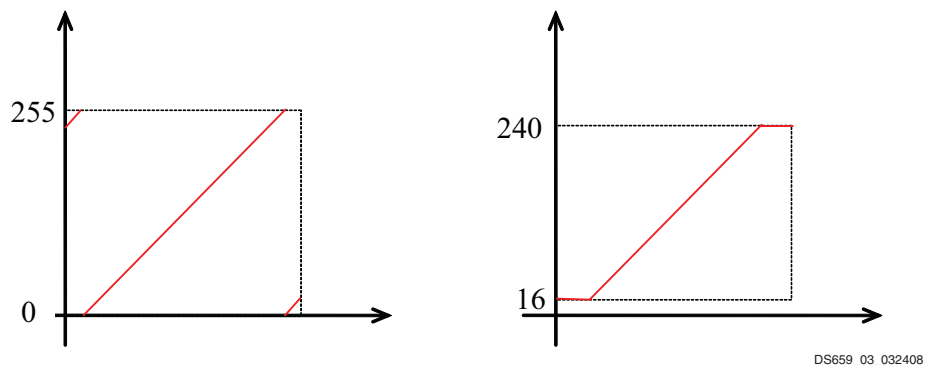

Figure 3-4: Wrap-Around and Saturation

DS659 03 032408

# Clock, Enable, and Reset Considerations

## ACLK

The master and slave AXI4-Stream video interfaces use the `ACLK` clock signal as their shared clock reference, as shown in Figure 3-5.

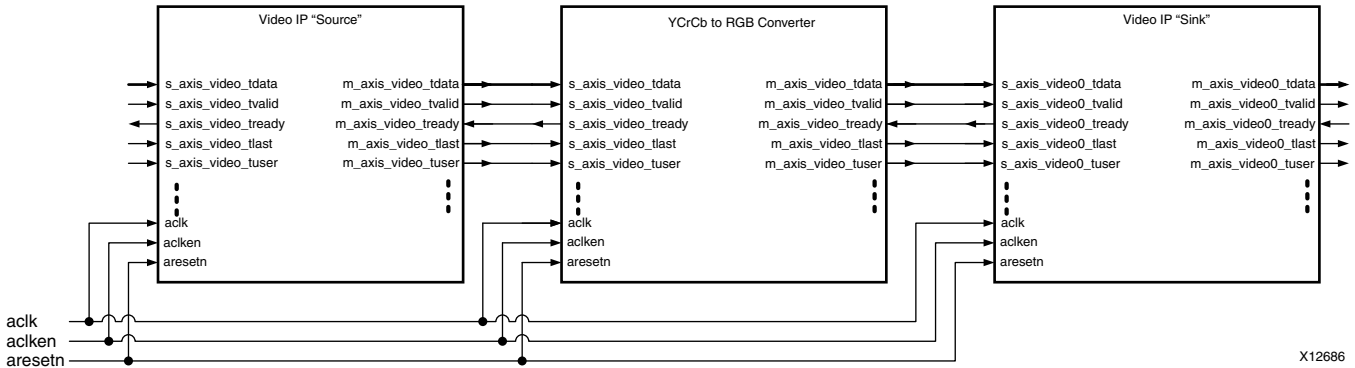

Figure 3-5: Example of ACLK Routing in an ISP Processing Pipeline

X12686

## S\_AXI\_ACLK

The AXI4-Lite interface uses the `A_AXI_ACLK` pin as its clock source. The `ACLK` pin is not shared between the AXI4-Lite and AXI4-Stream interfaces. The core contains clock-domain crossing logic between the `ACLK` (AXI4-Stream and Video Processing) and `S_AXI_ACLK` (AXI4-Lite) clock domains. The core automatically ensures that the AXI4-Lite transactions will complete even if the video processing is stalled with `ARESETn`, `ACLKEN` or with the video clock not running.

## ACLKEN

The YCrCb2RGB core has two enable options: the `ACLKEN` pin (hardware clock enable), and the software reset option provided via the AXI4-Lite control interface (when present).

`ACLKEN` is by no means synchronized internally to AXI4-Stream frame processing therefore de-asserting `ACLKEN` for extended periods of time may lead to image tearing.

The `ACLKEN` pin facilitates:

- Multi-cycle path designs (high speed clock division without clock gating),
- Standby operation of subsystems to save on power
- Hardware controlled bring-up of system components



**IMPORTANT:** When `ACLKEN` (clock enable) pins are used (toggled) in conjunction with a common clock source driving the master and slave sides of an AXI4-Stream interface, the `ACLKEN` pins associated with the master and slave component interfaces must also be driven by the same signal to prevent transaction errors (Figure 2-3).



---

**IMPORTANT:** *When two cores connected via AXI4-Stream interfaces, where only the master or the slave interface has an ACLKEN port, which is not permanently tied high, the two interfaces should be connected via the AXI4-Stream Interconnect or AXI-FIFO cores to avoid data corruption (Figure 2-4).*

---

## S\_AXI\_ACLKEN

The S\_AXI\_ACLKEN is the clock enable signal for the AXI4-Lite interface only. Driving this signal low will only affect the AXI4-Lite interface and will not halt the video processing in the ACLK clock domain.

## ARESETn

The CFA core has two reset source: the ARESETn pin (hardware reset), and the software reset option provided via the AXI4-Lite control interface (when present).



---

**IMPORTANT:** *ARESETn is by no means synchronized internally to AXI4-Stream frame processing, therefore de-asserting ARESETn while a frame is being process will lead to image tearing.*

---

The external reset pulse needs to be held for 32 ACLK cycles to reset the core. The ARESETn signal will only reset the AXI4-Stream interfaces. The AXI4-Lite interface is unaffected by the ARESETn signal to allow the video processing core to be reset without halting the AXI4-Lite interface.



---

**IMPORTANT:** *When a system with multiple-clocks and corresponding reset signals are being reset, the reset generator has to ensure all reset signals are asserted/de-asserted long enough that all interfaces and clock-domains in all IP cores are correctly reinitialized.*

---

## S\_AXI\_ARESETn

The S\_AXI\_ARESETn signal is synchronous to the S\_AXI\_ACLK clock domain, but is internally synchronized to the ACLK clock domain. The S\_AXI\_ARESETn signal will reset the entire core including the AXI4-Lite and AXI4-Stream interfaces.

---

## System Considerations

When using the YCrCb2RGB, it needs to be configured for the actual image sensor frame size the proper color-space conversion, to operate properly. To gather the frame size information from the video, it can be connected to the Video In to AXI-Stream input and the Video Timing Controller. The timing detector logic in the Video Timing Controller will gather the video timing signals. The AXI4-Lite control interface on the Video Timing Controller allows the system processor to read out the measured frame dimensions, and

program all downstream cores, such as the YCrCb2RGB, with the appropriate image dimensions.

If the target system uses only one unchanging setup, the user may choose to consolidate the register values, and create a constant configuration by removing the AXI4-Lite interface. This option allows reducing the core Slice footprint.

## Clock Domain Interaction

The `ARESETn` and `ACLKEN` input signals will not reset or halt the AXI4-Lite interface. This allows the video processing to be reset or halted separately from the AXI4-Lite interface without disrupting AXI4-Lite transactions.

The AXI4-Lite interface will respond with an error if the core registers cannot be read or written within 128 `S_AXI_ACLK` clock cycles. The core registers cannot be read or written if the `ARESETn` signal is held low, if the `ACLKEN` signal is held low or if the `ACLK` signal is not connected or not running. If core register read does not complete, the AXI4-Lite read transaction will respond with **10** on the `S_AXI_RRESP` bus. Similarly, if a core register write does not complete, the AXI4-Lite write transaction will respond with **10** on the `S_AXI_BRESP` bus. The `S_AXI_ARESETn` input signal resets the entire core.

## Programming Sequence

If processing parameters such as the image size needs to be changed on the fly, or the system needs to be reinitialized, it is recommended that pipelined Xilinx IP video cores are disabled/reset from system output towards the system input, and programmed/enabled from system input to system output. `STATUS` register bits allow system processors to identify the processing states of individual constituent cores, and successively disable a pipeline as one core after another is finished processing the last frame of data.

## Error Propagation and Recovery

Parameterization and/or configuration registers define the dimensions of video frames video IP should process. Starting from a known state, based on these configuration settings the IP can predict when the beginning of the next frame is expected. Similarly, the IP can predict when the last pixel of each scan line is expected. SOF detected before it was expected (early), or SOF not present when it is expected (late), EOL detected before expected (early), or EOL not present when expected (late), signals error conditions indicative of either upstream communication errors or incorrect core configuration.

When SOF is detected early, the output SOF signal is generated early, terminating the previous frame immediately. When SOF is detected late, the output SOF signal is generated according to the programmed values. Extra lines / pixels from the previous frame are dropped until the input SOF is captured.

Similarly, when EOL is detected early, the output EOL signal is generated early, terminating the previous line immediately. When EOL is detected late, the output EOL signal is generated according to the programmed values. Extra pixels from the previous line are dropped until the input EOL is captured.

# C Model Reference

---

## Installation and Directory Structure

This chapter contains information for installing the YCrCb to RGB Color-Space Converter C-Model, and describes the file contents and directory structure.

### Software Requirements

The YCrCb to RGB Color-Space Converter v6.01.a C-models were compiled and tested with the following software versions.

*Table 4-1: Supported Systems and Software Requirements*

Platform	C-Compiler
Linux 32-bit and 64-bit	GCC 4.1.1
Windows 32-bit and 64-bit	Microsoft Visual Studio 2005, Visual Studio 2008 (Visual C++ 8.0)

### Installation

The installation of the C-Model requires updates to the PATH variable, as described below.

#### Linux

Ensure that the directory in which the `libIp_v_ycrCb2rgb_v6_01_a_bitacc_cmodel.so` and `libstlport.so.5.1` files are located is in your `$LD_LIBRARY_PATH` environment variable.

## C-Model File Contents

Unzipping the `v_ycrCb2rgb_v6_01_a_bitacc_model.zip` file creates the following directory structures and files which are described in [Table 4-2](#).

**Table 4-2: C-Model Files**

File	Description
/lin	Pre-compiled bit accurate ANSI C reference model for simulation on 32-bit Linux Platforms
libIp_v_ycrcb2rgb_v6_01_a_bitacc_cmodel.lib	YCrCb to RGB Color-Space Converter v6.01.a model shared object library (Linux platforms only)
libstlport.so.5.1	STL library, referenced by the YCrCb to RGB Color-Space Converter library (Linux platforms only)
run_bitacc_cmodel	Pre-compiled bit accurate executable for simulation on 32-bit Linux Platforms
/lin64	Pre-compiled bit accurate ANSI C reference model for simulation on 64-bit Linux Platforms
libIp_v_ycrcb2rgb_v6_01_a_bitacc_cmodel.lib	YCrCb to RGB Color-Space Converter v6.01.a model shared object library (Linux platforms only)
libstlport.so.5.1	STL library, referenced by the YCrCb to RGB Color-Space Converter library (Linux platforms only)
run_bitacc_cmodel	Pre-compiled bit accurate executable for simulation on 32-bit Linux Platforms
/nt	Pre-compiled bit accurate ANSI C reference model for simulation on 32-bit Windows Platforms
libIp_v_ycrcb2rgb_v6_01_a_bitacc_cmodel.lib	Pre-compiled library file for win32 compilation
run_bitacc_cmodel.exe	Pre-compiled bit accurate executable for simulation on 32-bit Windows Platforms
/nt64	Pre-compiled bit accurate ANSI C reference model for simulation on 64-bit Windows Platforms
libIp_v_ycrcb2rgb_v6_01_a_bitacc_cmodel.lib	Pre-compiled library file for win32 compilation
run_bitacc_cmodel.exe	Pre-compiled bit accurate executable for simulation on 64-bit Windows Platforms
README.txt	Release notes
pg014_v_ycrcb2rgb.pdf	<i>YCrCb to RGB Color-Space Converter Core Product Guide</i>
v_ycrcb2rgb_v6_01_a_bitacc_cmodel.h	Model header file
rgb_utils.h	Header file declaring the RGB image / video container type and support functions
bmp_utils.h	Header file declaring the bitmap (.bmp) image file I/O functions

Table 4-2: C-Model Files (Cont'd)

File	Description
video_utils.h	Header file declaring the generalized image / video container type, I/O and support functions.
Test_stimuli.bmp	32x32 sample test image
run_bittacc_cmodel.c	Example code calling the C-Model

## Using the C-Model

The bit accurate C model is accessed through a set of functions and data structures that are declared in the `v_ycrb2rgb_v6_01_a_bitacc_cmodel.h` file. Before using the model, the structures holding the inputs, generics and output of the YCrCb to RGB Color-Space Converter instance must be defined:

```

struct xilinx_ip_v_ycrb2rgb_v6_01_a_generics generics;
struct xilinx_ip_v_ycrb2rgb_v6_01_a_inputs inputs;
struct xilinx_ip_v_ycrb2rgb_v6_01_a_outputs outputs;
    
```

The declaration of these structures is in the `v_ycrb2rgb_v6_01_a_bitacc_cmodel.h` file. Table 4-3 lists the generic parameters taken by the YCrCb to RGB Color-Space Converter v4.0 IP core bit accurate model, as well as the default values.

Table 4-3: Core Generic Parameters and Default Values

Generic Variable	Type	Default Value	Range	Description
ACTIVE_COLS	int	1920	0-7680	Active # of Columns
ACTIVE_ROWS	int	1080	0-7680	Active # of Rows
COEF_IN	ykrb_coef_inputs			YCC coefficient input structure
COEF_OUT	ykrb_coef_outputs			YCC coefficient output structure
RGBMAX	int	240	0 - 2OWIDTH-1	Clipping value for the R, G and B Channels
RGBMIN	int	16	0 - 2OWIDTH-1	Clipping value for the R, G and B Channels
HAS_CLIP	int	1	0,1	Determines if Clipping is performed on the output data
HAS_CLAMP	int	1	0,1	Determines if Clamping is performed on the output data



Table 4-3: Core Generic Parameters and Default Values (Cont'd)

STANDARD_SEL	int	0	0,1,2,3	Standard Selection 0 = SD_ITU_601 1 = HD_ITU_709__1125_NTSC 2 = HD_ITU_709__1250_PAL 3 = YUV
INPUT_RANGE	int	0	0,1,2	Input Range 0 = 16_to_240_for_TV, 1 = 16_to_235_for_Studio_Equipment 2 = 0_to_255_for_Computer_Graphics

Table 4-4: ycrCb\_coef\_inputs Structure

Variable	Type	Default Value	Range	Description
IWIDTH	int	8	8,10,12,16	Data Width
ACOEf	double	0.299	0.0 - 1.0	CA GUI coefficient
BCOEf	double	0.114	0.0 - 1.0	CB GUI coefficient
CCOEf	double	0.713	0.0 - 0.9	CC GUI coefficient
DCOEf	double	0.564	0.0 - 0.9	CD GUI coefficient
YOFFSET	int	16	0 - $2^{IWIDTH}-1$	GUI YOFFSET
CBOFFSET	int	128	0 - $2^{IWIDTH}-1$	GUI CBOFFSET
CROFFSET	int	128	0 - $2^{IWIDTH}-1$	GUI CROFFSET

Table 4-5: ycrCb\_coef\_output Structure

Variable	Type	Default Value	Range	Description
IWIDTH	int	8	8,10,12,16	Data Width
ACOEf	int	91907	$-2^{17}.. 2^{17}-1$	Transformed CA coefficient
BCOEf	int	-46751	$-2^{17}.. 2^{17}-1$	Transformed CB coefficient
CCOEf	int	-22503	$-2^{17}.. 2^{17}-1$	Transformed CC coefficient
DCOEf	int	116156	$-2^{17}.. 2^{17}-1$	Transformed CD coefficient
ROFFSET	int	-45953	$-2^{31} - 2^{31}-1$	Transformed YOFFSET
GOFFSET	int	34627	$-2^{31} - 2^{31}-1$	Transformed CBOFFSET
BOFFSET	int	- 58077	$-2^{31} - 2^{31}-1$	Transformed CROFFSET

Calling `xilinx_ip_v_ycrcb2rgb_v6_01_a_get_default_generics(&generics)` initializes the `generics` structure with the default value.

The `inputs` structure defines the actual input image. For the description of the input video structure, see [Input and Output Video Structures](#).

Calling `xilinx_ip_v_ycrcb2rgb_v6_01_a_get_default_inputs(&generics, &inputs)` initializes the input video structure before it can be assigned an image or video sequence using the memory allocation or file I/O functions provided in the BMP, RGB or video utility functions.

**Note:** The `video_in` variable is not initialized to point to a valid image / video container, as the container size depends on the actual test image to be simulated. The initialization of the `video_in` structure is described in [Initializing the Input Video Structure](#).

After the inputs are defined, the model can be simulated by calling this function:

```
int xilinx_ip_v_ycrb2rgb_v6_01_a_bitacc_simulate(
    struct xilinx_ip_v_ycrb2rgb_v6_01_a_generics* generics,
    struct xilinx_ip_v_ycrb2rgb_v6_01_a_inputs* inputs,
    struct xilinx_ip_v_ycrb2rgb_v6_01_a_outputs* outputs).
```

Results are included in the `outputs` structure, which contains only one member, type `video_struct`. After the outputs are evaluated and saved, dynamically allocated memory for input and output video structures must be released by calling this function:

```
void xilinx_ip_v_ycrb2rgb_v6_01_a_destroy(
    struct xilinx_ip_v_ycrb2rgb_v6_01_a_inputs *input,
    struct xilinx_ip_v_ycrb2rgb_v6_01_a_outputs *output).
```

Successful execution of all provided functions, except for the destroy function, return value 0. A non-zero error code indicates that problems occurred during function calls.

## Input and Output Video Structures

Input images or video streams can be provided to the YCrCb to RGB Color-Space Converter v4.0 reference model using the `video_struct` structure, defined in `video_utils.h`:

```
struct video_struct{
    int frames, rows, cols, bits_per_component, mode;
    uint16*** data[5]; };
```

Table 4-6: Member Variables of the Video Structure

Member Variable	Designation
frames	Number of video/image frames in the data structure.
rows	Number of rows per frame. Pertaining to the image plane with the most rows and columns, such as the luminance channel for YUV data. Frame dimensions are assumed constant through all frames of the video stream. However different planes, such as y, u and v can have different dimensions.
cols	Number of columns per frame. Pertaining to the image plane with the most rows and columns, such as the luminance channel for YUV data. Frame dimensions are assumed constant through all frames of the video stream. However different planes, such as y, u and v can have different dimensions.
bits_per_component	Number of bits per color channel/component. All image planes are assumed to have the same color/component representation. Maximum number of bits per component is 16.

Table 4-6: Member Variables of the Video Structure (Cont'd)

mode	Contains information about the designation of data planes. Named constants to be assigned to mode are listed in Table 4-7.
data	Set of five pointers to three dimensional arrays containing data for image planes. Data is in 16-bit unsigned integer format accessed as data[plane][frame][row][col].

Table 4-7: Named Video Modes with Corresponding Planes and Representations<sup>1</sup>

Mode	Planes	Video Representation
FORMAT_MONO	1	Monochrome – Luminance only
FORMAT_RGB	3	RGB image/video data
FORMAT_C444	3	444 YUV, or YCrCb image/video data
FORMAT_C422	3	422 format YUV video, (u, v chrominance channels horizontally sub-sampled)
FORMAT_C420	3	420 format YUV video, (u, v sub-sampled both horizontally and vertically)
FORMAT_MONO_M	3	Monochrome (Luminance) video with Motion
FORMAT_RGBA	4	RGB image/video data with alpha (transparency) channel
FORMAT_C420_M	5	420 YUV video with Motion
FORMAT_C422_M	5	422 YUV video with Motion
FORMAT_C444_M	5	444 YUV video with Motion
FORMAT_RGBM	5	RGB video with Motion

<sup>1</sup> The Color Space Conversion core C model supports FORMAT\_C444 for input data and FORMAT\_RGB for output data.

## Initializing the Input Video Structure

The easiest way to assign stimuli values to the input video structure is to initialize it with an image or video. The `yuv_utils.h`, `bmp_util.h` and `video_util.h` header files packaged with the bit accurate C models contain functions to facilitate file I/O.

### Bitmap Image Files

The header `bmp_utils.h` declares functions that help access files in Windows Bitmap format ([http://en.wikipedia.org/wiki/BMP\\_file\\_format](http://en.wikipedia.org/wiki/BMP_file_format)). However, this format limits color depth to a maximum of 8-bits per pixel, and operates on images with three planes (R,G,B). Consequently, the following functions operate on arguments type `rgb8_video_struct`, which is defined in `rgb_utils.h`. Also, both functions support only true-color, non-indexed formats with 24-bits per pixel.

```
int write_bmp(FILE *outfile, struct rgb8_video_struct *rgb8_video);
int read_bmp(FILE *infile, struct rgb8_video_struct *rgb8_video);
```

Exchanging data between `rgb8_video_struct` and general `video_struct` type frames/videos is facilitated by these functions:

```
int copy_rgb8_to_video(struct rgb8_video_struct* rgb8_in,
                     struct video_struct* video_out );
int copy_video_to_rgb8(struct video_struct* video_in,
                     struct rgb8_video_struct* rgb8_out );
```

**Note:** All image/video manipulation utility functions expect both input and output structures initialized; for example, pointing to a structure that has been allocated in memory, either as static or dynamic variables. Moreover, the input structure must have the dynamically allocated container (data or r, g, b) structures already allocated and initialized with the input frame(s). If the output container structure is pre-allocated at the time of the function call, the utility functions verify and issue an error if the output container size does not match the size of the expected output.

## Binary Image/Video Files

The `video_utils.h` header file declares functions that help load and save generalized video files in raw, uncompressed format.

```
int read_video( FILE* infile, struct video_struct* in_video);
int write_video(FILE* outfile, struct video_struct* out_video);
```

These functions serialize the `video_struct` structure. The corresponding file contains a small, plain text header defining, "Mode", "Frames", "Rows", "Columns", and "Bits per Pixel". The plain text header is followed by binary data, 16-bits per component in scan line continuous format. Subsequent frames contain as many component planes as defined by the video mode value selected. Also, the size (rows, columns) of component planes can differ within each frame as defined by the actual video mode selected.

## YUV Image Files

The `yuv_utils.h` file declares functions that help access files in standard YUV format. It operates on images with three planes (Y, U and V). The following functions operate on arguments of type `yuv8_video_struct`, which is defined in `yuv_utils.h`:

```
int write_yuv8(FILE *outfile, struct yuv8_video_struct *yuv8_video);
int read_yuv8(FILE *infile, struct yuv8_video_struct *yuv8_video);
```

Exchanging data between `yuv8_video_struct` and general `video_struct` type frames/videos is facilitated by these functions:

```
int copy_yuv8_to_video(struct yuv8_video_struct* yuv8_in,
                     struct video_struct* video_out );
int copy_video_to_yuv8(struct video_struct* video_in,
                     struct yuv8_video_struct* yuv8_out );
```

**Note:** All image/video manipulation utility functions expect both input and output structures initialized; for example, pointing to a structure that has been allocated in memory, either as static or dynamic variables. Moreover, the input structure must have the dynamically allocated container (data or y, u, v) structures already allocated and initialized with the input frame(s). If the output

container structure is pre-allocated at the time of the function call, the utility functions verify and issue an error if the output container size does not match the size of the expected output.

## Working with Video\_struct Containers

The `video_utils.h` header file defines functions to simplify access to video data in `video_struct`.

```
int video_planes_per_mode(int mode);
int video_rows_per_plane(struct video_struct* video, int plane);
int video_cols_per_plane(struct video_struct* video, int plane);
```

The `video_planes_per_mode` function returns the number of component planes defined by the mode variable, as described in Table 4-7. The `video_rows_per_plane` and `video_cols_per_plane` functions return the number of rows and columns in a given plane of the selected video structure. The following example demonstrates using these functions in conjunction to process all pixels within a video stream stored in the `in_video` variable:

```
for (int frame = 0; frame < in_video->frames; frame++) {
    for (int plane = 0; plane < video_planes_per_mode(in_video->mode); plane++) {
        for (int row = 0; row < rows_per_plane(in_video,plane); row++) {
            for (int col = 0; col < cols_per_plane(in_video,plane); col++) {
                // User defined pixel operations on
                // in_video->data[plane][frame][row][col]
            }
        }
    }
}
```

## C-Model Example Code

The example C demonstrator provided with the core, `run_bitacc_cmodel.c` demonstrates the steps required to run the C-model, by:

- Opening an example yuv file
- Increasing the color-component width to 10, 12, or 16 bits as necessary by shifting 8 bit data derived from the yuv file and padding the LSBs with X-Y ramp bits.
- Running the YCrCb2RGB C-model

After following the compilation instructions, run the example executable. The executable takes the path/name of the input file and the path of the output as parameters. If invoked with insufficient parameters, the following help message is printed:

```
Usage: run_bitacc_cmodel in_file out_path
       in_file       : path/name of the input YUV file
       out_path      : path to the output files
```

During successful execution, two directories will be created at the location specified by the `out_path` command line parameter. The first directory is the "expected" directory. This

directory will contain a BMP file that corresponds to the output of the first frame that was processed. This directory will also contain a txt file called `golden_1.txt`. This txt file contains the output of the model in a format that can be directly used with the demonstration test bench. The second directory that is created is the "stimuli" directory. This directory will contain a txt file called `stimuli_1.txt`. This txt file contains the input of the model in a format that can be directly used with the demonstration test bench.

---

## Compiling with the YCrCb to RGB C-Model

### Linux (32- and 64-bit)

To compile the example code, first ensure that the directory in which the files `libIp_v_ycrCb2rgb_v6_01_a_bitacc_cmodel.so` and `libstlport.so.5.1` are located is present in your `$LD_LIBRARY_PATH` environment variable. These shared libraries are referenced during the compilation and linking process. Then `cd` into the directory where the header files, library files and `run_bitacc_cmodel.c` were unpacked. The libraries and header files are referenced during the compilation and linking process.

Place the header file and C source file in a single directory. Then in that directory, compile using the GNU C Compiler:

```
gcc -m32 -x c++ ../run_bitacc_cmodel.c ../gen_stim.c -o run_bitacc_cmodel -L.  
-lIp_v_ycrCb2rgb_v6_01_a_bitacc_cmodel -Wl,-rpath,.  
  
gcc -m64 -x c++ ../run_bitacc_cmodel.c ../gen_stim.c -o run_bitacc_cmodel -L.  
-lIp_v_ycrCb2rgb_v6_01_a_bitacc_cmodel -Wl,-rpath,.
```

### Windows (32- and 64-bit)

Precompiled library `v_ycrCb2rgb_v6_01_a_bitacc_cmodel.dll`, and top level demonstration code `run_bitacc_cmodel.c` should be compiled with an ANSI C compliant compiler under Windows. Here an example is presented using Microsoft Visual Studio.

In Visual Studio create a new, empty Windows Console Application project. As existing items, add:

- The `libIP_v_ycrCb2rgb_v6_01_a_bitacc_cmodel.dll` file to the "Resource Files" folder of the project
- The `run_bitacc_cmodel.c` and `gen_stim.c` files to the "Source Files" folder of the project
- The `v_ycrCb2rgb_v6_01_a_bitacc_cmodel.h` header files to "Header Files" folder of the project (optional)

After the project has been created and populated, it needs to be compiled and linked (built) to create a win32 executable. To perform the build step, choose **Build Solution** from the Build menu. An executable matching the project name has been created either in the Debug or Release subdirectories under the project location based on whether **Debug** or **Release** has been selected in the **Configuration Manager** under the Build menu.

## SECTION II: VIVADO DESIGN SUITE

Customizing and Generating the Core

Constraining the Core

Detailed Example Design



# Customizing and Generating the Core

This chapter includes information about using Xilinx tools to customize and generate the core in the Vivado Design Suite environment.

---

## Graphical User Interface

The main screen of the Graphical User Interface (GUI) of Vivado IP Catalog shown in [Figure 5-1](#) allows quick implementation of standard YCrCb to RGB or YUV to RGB converters without having to manually enter values from [Table 3-2](#), [Table 3-3](#) and [Table 3-4](#). The Color-Space Converter core also supports proprietary (non-standard) converter implementations, by selecting “custom” from the Standard Selection drop-down menu, as long as the custom conversion matrix can be transformed to the form of [Equation 3-3](#). Descriptions of the options provided in the GUI screens are included in this section.

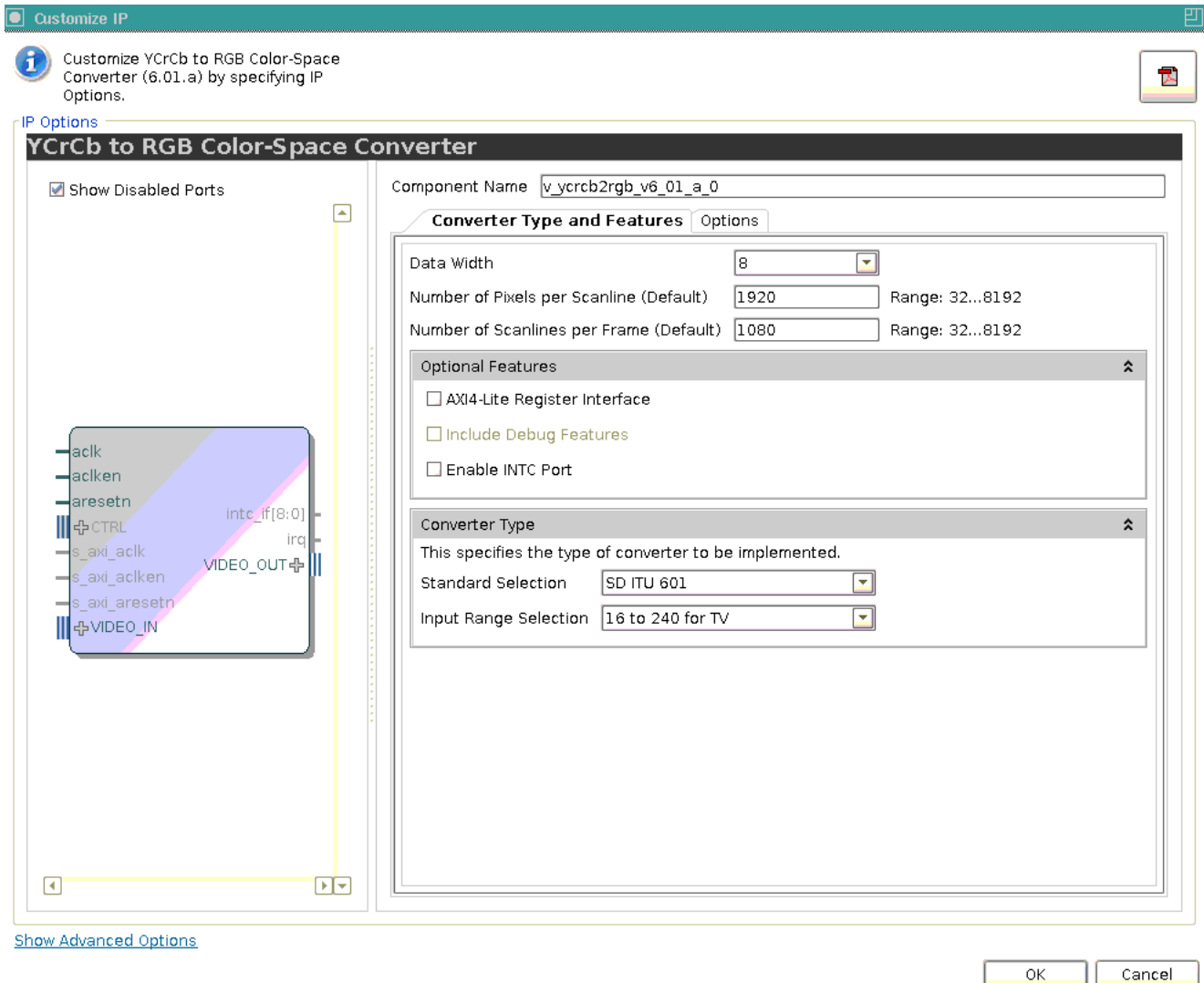

Figure 5-1: Color Space Converter Main Screen

The first page of the GUI displays the following options:

- **Component Name:** The component name is used as the base name of output files generated for the module. Names must begin with a letter and must be composed from characters: a to z, 0 to 9 and "\_". The name v\_ycrCb2rgb\_v6\_01\_a cannot be used as a component name.
- **Data Width:** Specifies the bit width of input samples. Permitted values are 8, 10, 12 and 16 bits.
- **Number of Active Pixels per Scan line:** When the AXI4-Lite control interface is enabled, the generated core will use the value specified in the CORE Generator GUI as the default value for the lower half-word of the ACTIVE\_SIZE register. When an AXI4-Lite interface is not present, the GUI selection permanently defines the horizontal size of the frames the generated core instance is to process.

- **Number of Active Lines per Frame:** When the AXI4-Lite control interface is enabled, the generated core will use the value specified in the CORE Generator GUI as the default value for the upper half-word of the ACTIVE\_SIZE register. When an AXI4-Lite interface is not present, the GUI selection permanently defines the vertical size (number of lines) of the frames the generated core instance is to process.
- **Optional Features:**
  - **AXI4-Lite Register Interface:** When selected, the core will be generated with an AXI4-Lite interface, which gives access to dynamically program and change processing parameters. For more information, refer to Control Interface in Chapter 2.
  - **Include Debugging Features:** When selected, the core will be generated with debugging features, which simplify system design, testing and debugging. For more information, refer to Debugging Features in Appendix C.

**Note:** Debugging features are only available when the AXI4-Lite Register Interface is selected.
- **Enable INTC Port:** When selected, the core will generate the optional INTC\_IF port, which gives parallel access to signals indicating frame processing status and error conditions. For more information, refer to The Interrupt Subsystem in Chapter 2.
- Converter Type
  - **Standard Selection:** Select the standard to be implemented. The offered standards are:
    - YCrCb *ITU 601* (SD)
    - YCrCb *ITU 709* (HD) 1125/60 (PAL)
    - YCrCb *ITU 709* (HD) 1250/50 (NTSC)
    - YUV
    - custom

Selecting “custom” enables the controls on page 2 of the GUI, so conversion settings can be customized. Otherwise, page 2 only displays the parameters to implement the selected standard.

- **Output Range Selection:** This selection governs the range of outputs R, G and B by affecting the conversion coefficients as well as the clipping and clamping values. The core supports typical output ranges:
  - 16 to 235, typical for studio equipment
  - 16 to 240, typical for broadcast or television
  - 0 to 255, typical for computer graphics

The previously-mentioned ranges are characteristic for 8-bit outputs. If 10-, 12- or 16-bit outputs are used, the ranges are extended proportionally. For example, 16 to 240 mode for 10-bit outputs will result in output values ranging from 64 to 960.

The Conversion Matrix, Offset Compensation, Clipping and Clamping screen displays and enables editing of conversion coefficients, similar to Equation 3-3. Contents are editable only when "custom" is selected as the standard on page 1 (Figure 5-2).

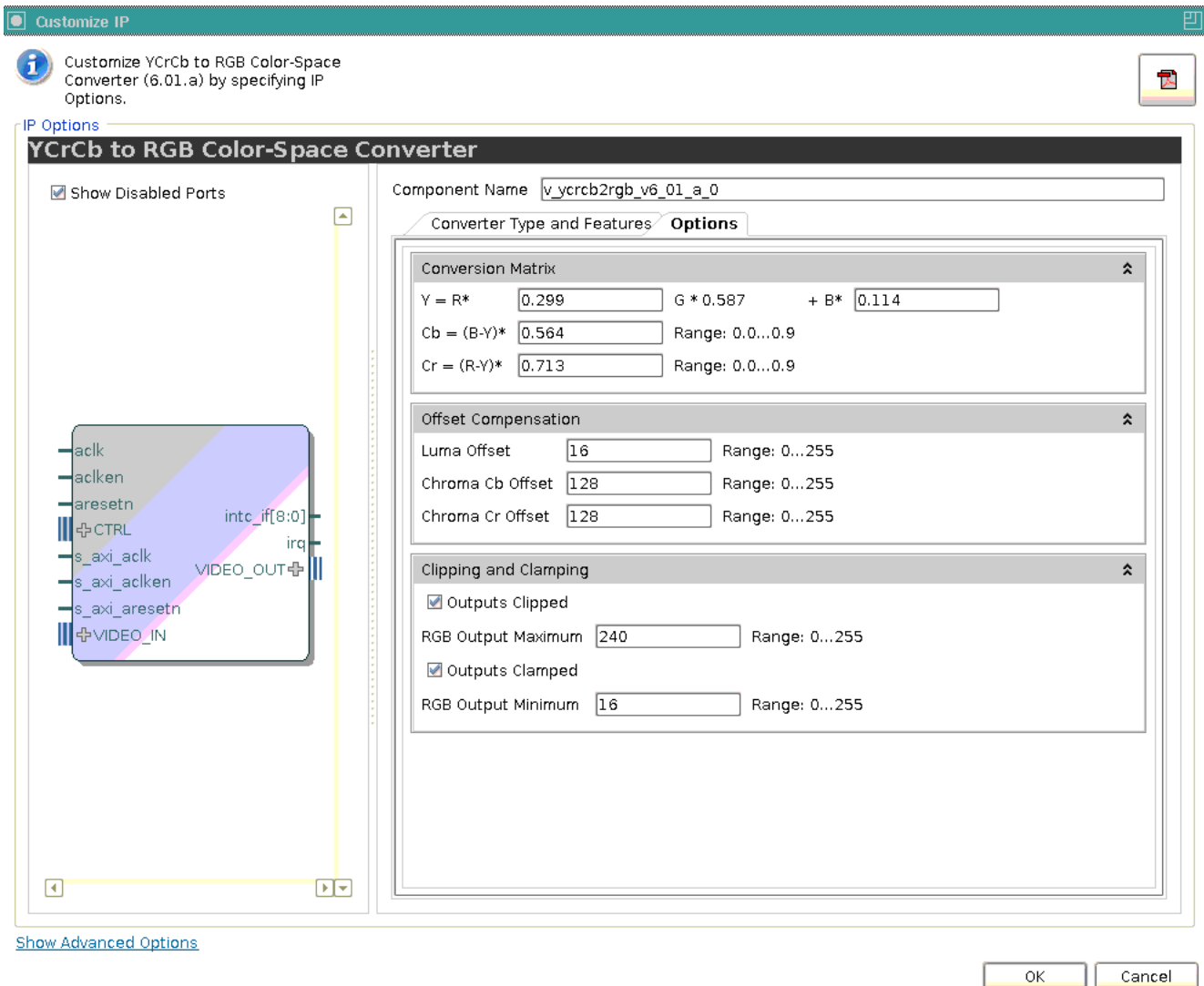

Figure 5-2: Conversion Matrix, Offset Compensation, Clipping and Clamping Screen

- **Conversion Matrix:** Enter floating-point conversion constants, ranging from 0 to 1, into the four fields representing CA, CB, CC and CD.
- **Offset Compensation:** Enter the offset compensation constants ( $O_Y$ ,  $O_{Cb}$ , and  $O_{Cr}$  in Equation 3-17, Equation 3-18 and Equation 3-19). These constants are scaled to the output representation. If  $O_Y$ ,  $O_{Cb}$ , and  $O_{Cr}$  are in the 0.0 - 1.0 range, and the output is

represented as 10-bit unsigned integers, then luminance and chrominance offsets should be entered as integers in the 0 - 1023 range.

- **Outputs Clipped/Outputs Clamped:** These check boxes control whether clipping/clamping logic will be instantiated in the generated netlist. The clipping/clamping logic ensures no arithmetic wrap-arounds happen at overflows, at the expense of extra slice-based logic resources.
- **Minimum and Maximum Values:** Similar to offset values, the edit boxes take unsigned integer values in the range permitted by the current output representation.

## Output Generation

Vivado generates the files necessary to build the core and places those files in the `<project>/<project>.srcs/sources_1/ip/<core>` directory.

### File Details

The Vivado output consists of some or all the following files:

*Table 5-1:*

Name	Description
v_rgb2ycrcb_v6_01_a	Library directory for the v_ycrcb2rgb_v6_01_a core which contains the encrypted source files
v_tc_v5_01_a	Library directory for the helper core which contain the encrypted source files used with the v_ycrcb2rgb_v6_01_a
<component_name>.veo	The HDL template for instantiating the core.
<component_name>.vho	
<component_name>.xci	IP-XACT file describing which options were used to generate the core. An XCI file can also be used as a source file for Vivado
<component_name>.xml	IP-XACT XML file describing how the core is constructed so Vivado can properly build the core.

# Constraining the Core

---

## Required Constraints

The `ACLK` pin should be constrained at the desired pixel clock rate for your video stream.

The `S_AXI_ACLK` pin should be constrained at the frequency of the AXI4-Lite subsystem.

In addition to clock frequency, the following constraints should be applied to cover all clock domain crossing data paths.

### UCF

```
INST "*U_VIDEO_CTRL*/*SYNC2PROCCLK_I*/data_sync_reg[0]*" TNM =
  "async_clock_conv_FFDEST";
TIMESPEC "TS_async_clock_conv" = FROM FFS TO "async_clock_conv_FFDEST" 2 NS
DATAPATHONLY;
INST "*U_VIDEO_CTRLk*/*SYNC2VIDCLK_I*/data_sync_reg[0]*" TNM =
  "vid_async_clock_conv_FFDEST";
TIMESPEC "TS_vid_async_clock_conv" = FROM FFS TO "vid_async_clock_conv_FFDEST" 2 NS
DATAPATHONLY;
```

### XDC

```
set_max_delay -to [get_cells -hierarchical -match_style ucf "*U_VIDEO_CTRL*/
*SYNC2PROCCLK_I*/data_sync_reg[0]*"] -datapath_only 2

set_max_delay -to [get_cells -hierarchical -match_style ucf "*U_VIDEO_CTRL*/
*SYNC2VIDCLK_I*/data_sync_reg[0]*"] -datapath_only 2
```

---

## Device, Package, and Speed Grade Selections

There are no device, package, or speed grade requirements for this core. For a complete listing of supported devices, see the release notes for this core.

---

## Clock Frequencies

The pixel clock (`ACLK`) frequency is the required frequency for the Color Filter Array Interpolation core. See [Maximum Frequencies in Chapter 2](#). The `S_AXI_ACLK` maximum frequency is the same as the `ACLK` maximum.

---

## Clock Management

The core automatically handles clock domain crossing between the `ACLK` (video pixel clock and AXI4-Stream) and the `S_AXI_ACLK` (AXI4-Lite) clock domains. The `S_AXI_ACLK` clock can be slower or faster than the `ACLK` clock signal, but must not be more than 128x faster than `ACLK`.

---

## Clock Placement

There are no specific Clock placement requirements for this core.

---

## Banking

There are no specific Banking rules for this core.

---

## Transceiver Placement

There are no Transceiver Placement requirements for this core.

---

## I/O Standard and Placement

There are no specific I/O standards and placement requirements for this core.

# Detailed Example Design

No example design is available at the time for the LogiCORE IP YCrCb to RGB Color-Space Converter v6.01a core.

---

## Demonstration Test Bench

A demonstration test bench is provided with the core which enables you to observe core behavior in a typical scenario. This test bench is generated together with the core in Vivado design tools. You are encouraged to make simple modifications to the configurations and observe the changes in the waveform.

### Generating the Test Bench

1. After customizing the IP, right-click on the core instance in **Sources** pane and select **Generate Output Products** ([Figure 7-1](#)).



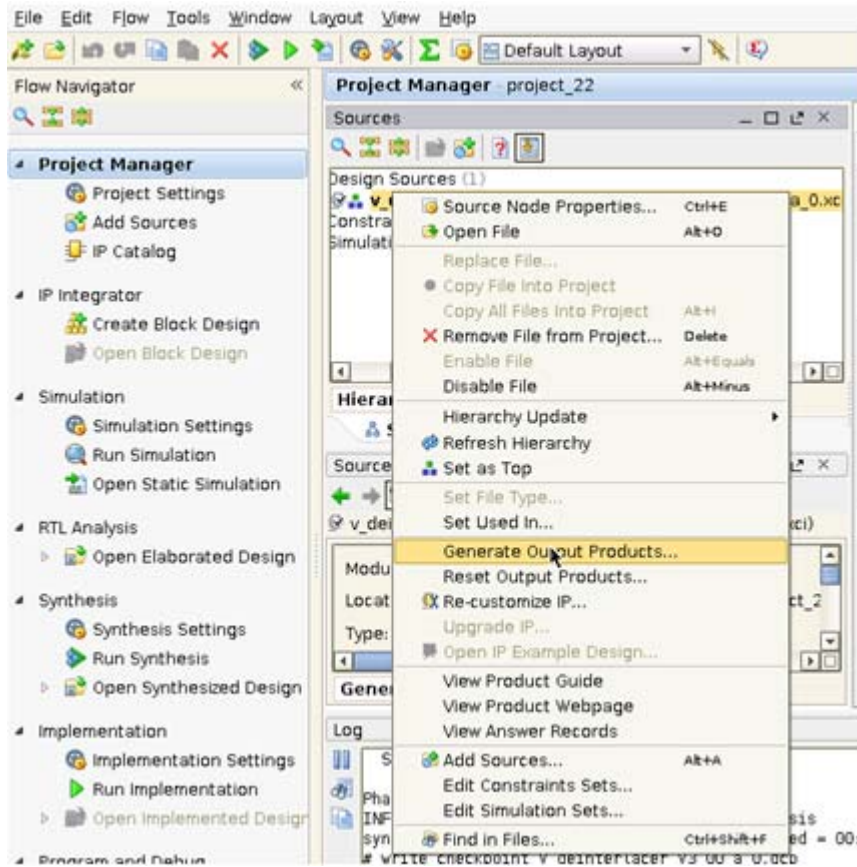

Figure 7-1: Sources Pane

A pop-up window prompts you to select items to generate.

2. Click on **Test Bench** and make sure **Action: Generate** is selected.

The demo test bench package will be generated in the following directory (Figure 7-2):

```
<PROJ_DIR>/<PROJ_NAME>.srcs/sources_1/ip/<IP_INSTANCE_NAME>/<IP_INSTANCE_NAME>/demo_tb/
```

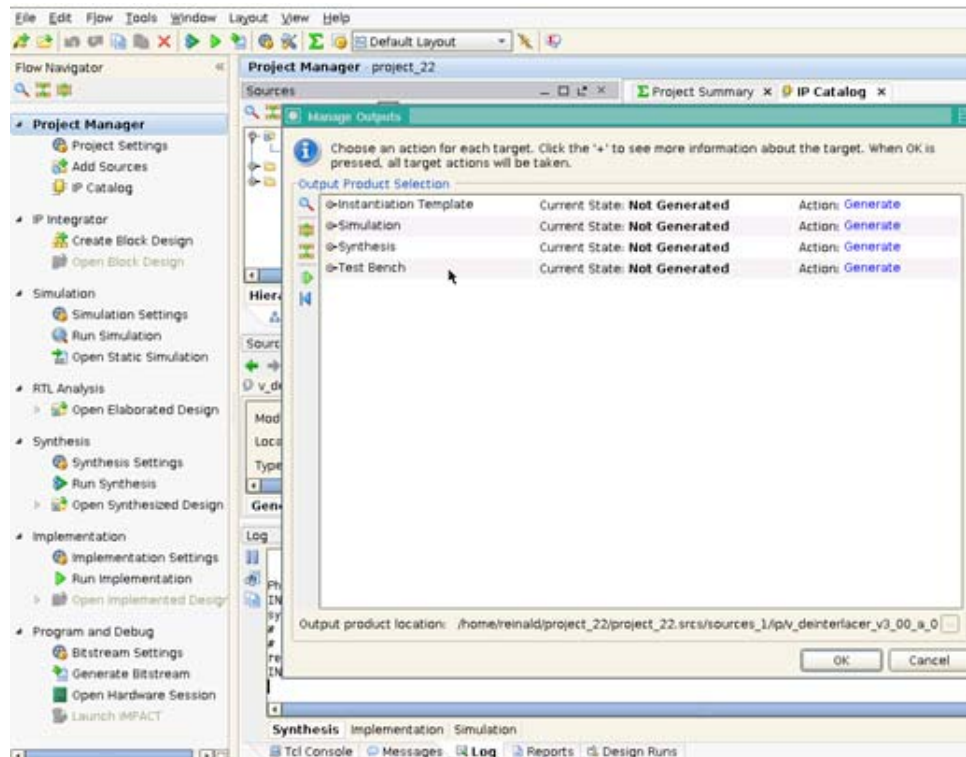

Figure 7-2: Test Bench

## Directory and File Contents

The following files are expected to be generated in the in the demo test bench output directory:

- axi4lite\_mst.v
- axi4s\_video\_mst.v
- axi4s\_video\_slv.v
- ce\_generator.v
- tb\_<IP\_instance\_name>.v

## Test Bench Structure

The top-level entity is **tb\_<IP\_instance\_name>**.

It instantiates the following modules:

- DUT
  - The <IP> core instance under test.
- axi4lite\_mst

The AXI4-Lite master module, which initiates AXI4-Lite transactions to program core registers.

- `axi4s_video_mst`

The AXI4-Stream master module, which generates ramp data and initiates AXI4-Stream transactions to provide video stimuli for the core and can also be used to open stimuli files generated from the reference C-models and convert them into corresponding AXI4-Stream transactions.

To do this, edit `tb_<IP_instance_name>.v`:

- Add define macro for the stimuli file name and directory path  

```
define STIMULI_FILE_NAME<path><filename>.
```
- Comment-out/remove the following line:  

```
MST.is_ramp_gen(`C_ACTIVE_ROWS, `C_ACTIVE_COLS, 2);
```

  
and replace with the following line:  

```
MST.use_file(`STIMULI_FILE_NAME);
```

For information on how to generate stimuli files, refer to [C Model Reference](#).

- `axi4s_video_slv`

The AXI4-Stream slave module, which acts as a passive slave to provide handshake signals for the AXI4-Stream transactions from the core's output, can be used to open the data files generated from the reference C-model and verify the output from the core.

To do this, edit `tb_<IP_instance_name>.v`:

- Add define macro for the golden file name and directory path  

```
define GOLDEN_FILE_NAME "<path><filename>".
```
- Comment-out the following line:  

```
SLV.is_passive;
```

  
and replace with the following line:  

```
SLV.use_file(`GOLDEN_FILE_NAME);
```

For information on how to generate golden files, refer to [C Model Reference](#).

- `ce_gen`

Programmable Clock Enable (ACLKEN) generator.

## Running the Simulation

There are two ways to run the demonstration test bench.

After successfully generating the core's output:

1. Launch Simulation from the Vivado design tools GUI.

This runs the test bench with the AXI4-Stream Master producing ramp data as stimuli, and AXI4-Stream Slave set to passive mode.

- Click **Simulation Settings** in the Flow Navigation window, change Simulation top module name to **tb\_<IP\_instance\_name>**.
- Click **Run Simulation**. XSIM launches and you should be able to see the signals.
- You can also choose Modelsim for simulation by going to **Project Settings** and selecting Modelsim as the Target Simulator ([Figure 7-3](#)).

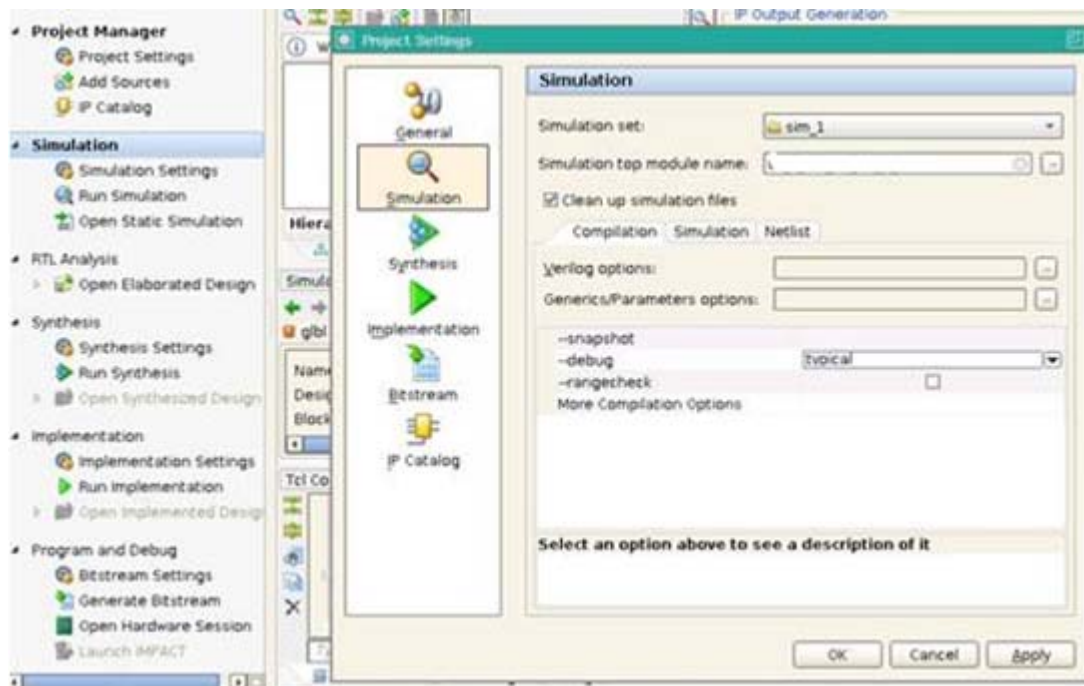

Figure 7-3: Simulation GUI

2. Manually compile and run simulation from your simulation environment.

- Add the generated test bench files to a new simulation set, along with the customized IP. For information on the location of generated test bench files, refer to [Generating the Test Bench](#).
- Setup the environment variables for Xilinx libraries
- Compile the generated IP
- Compile the test bench files
- Run the simulation

It is recommended to change the default simulation time from **1000 ns** to **all** to be able observe a full frame transaction.

## SECTION III: ISE DESIGN SUITE

Customizing and Generating the Core

Constraining the Core

Detailed Example Design

# Customizing and Generating the Core

This chapter includes information about using Xilinx tools to customize and generate the core in the ISE® Design Suite environment.

## Graphical User Interface

The main screen of the Graphical User Interface (GUI) of CORE Generator, shown in [Figure 8-1](#) (and EDK shown in [Figure 8-3](#)), allows quick implementation of standard YCrCb to RGB or YUV to RGB converters without having to manually enter values from [Table 3-2](#), [Table 3-3](#) and [Table 3-4](#). The Color-Space Converter core also supports proprietary (non-standard) converter implementations, by selecting "custom" from the Standard Selection drop-down menu, as long as the custom conversion matrix can be transformed to the form of [Equation 3-3](#). The front pages of the RGB to YCrCb and the YCrCb to RGB GUIs are very similar, allowing easy generation of complementing converter pairs.

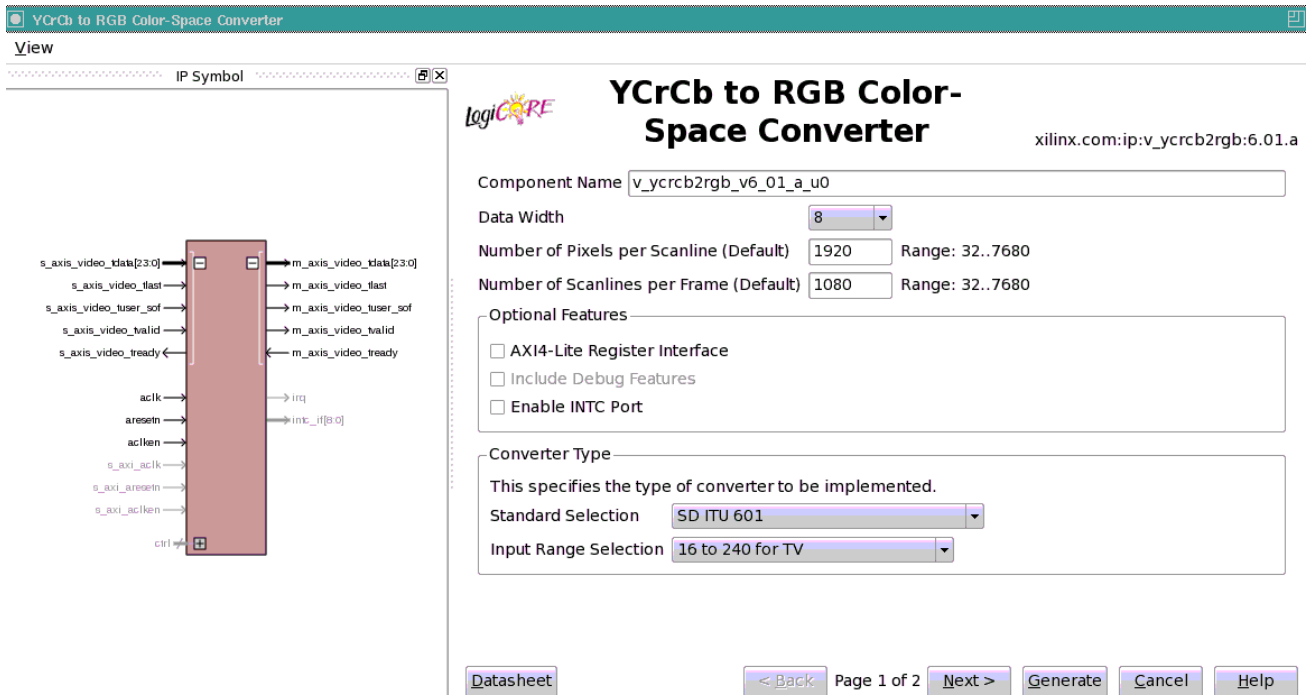

Figure 8-1: Color Space Converter Main Screen

The first page of the GUI displays the following options:

- **Component Name:** The component name is used as the base name of output files generated for the module. Names must begin with a letter and must be composed from characters: a to z, 0 to 9 and "\_". The name `v_ycrCb2rgb_v6_01_a` cannot be used as a component name.
- **Data Width:** Specifies the bit width of input samples. Permitted values are 8, 10, 12 and 16 bits.
- **Number of Active Pixels per Scan line:** When the AXI4-Lite control interface is enabled, the generated core will use the value specified in the CORE Generator GUI as the default value for the lower half-word of the `ACTIVE_SIZE` register. When an AXI4-Lite interface is not present, the GUI selection permanently defines the horizontal size of the frames the generated core instance is to process.
- **Number of Active Lines per Frame:** When the AXI4-Lite control interface is enabled, the generated core will use the value specified in the CORE Generator GUI as the default value for the upper half-word of the `ACTIVE_SIZE` register. When an AXI4-Lite interface is not present, the GUI selection permanently defines the vertical size (number of lines) of the frames the generated core instance is to process.
- **Optional Features:**
  - **AXI4-Lite Register Interface:** When selected, the core will be generated with an AXI4-Lite interface, which gives access to dynamically program and change processing parameters. For more information, refer to Control Interface in Chapter 2.
  - **Include Debugging Features:** When selected, the core will be generated with debugging features, which simplify system design, testing and debugging. For more information, refer to Debugging Features in Appendix C.  
  
*Note:* Debugging features are only available when the AXI4-Lite Register Interface is selected.
- **Enable INTC Port:** When selected, the core will generate the optional `INTC_IF` port, which gives parallel access to signals indicating frame processing status and error conditions. For more information, refer to The Interrupt Subsystem in Chapter 2.
- **Converter Type:**
  - **Standard Selection:** Select the standard to be implemented. The offered standards are:
    - YCrCb *ITU 601* (SD)
    - YCrCb *ITU 709* (HD) 1125/60 (PAL)
    - YCrCb *ITU 709* (HD) 1250/50 (NTSC)
    - YUV
    - custom

Selecting “custom” enables the controls on page 2 of the GUI, so conversion settings can be customized. Otherwise, page 2 only displays the parameters to implement the selected standard.

- **Output Range Selection:** This selection governs the range of outputs R, G and B by affecting the conversion coefficients as well as the clipping and clamping values. The core supports typical output ranges:
  - 16 to 235, typical for studio equipment
  - 16 to 240, typical for broadcast or television
  - 0 to 255, typical for computer graphics

The previously-mentioned ranges are characteristic for 8-bit outputs. If 10-, 12- or 16-bit outputs are used, the ranges are extended proportionally. For example, 16 to 240 mode for 10-bit outputs will result in output values ranging from 64 to 960.

The Conversion Matrix, Offset Compensation, Clipping and Clamping screen (Figure 8-2), displays and enables editing of conversion coefficients, similar to Equation 3-3. Contents are editable only when “custom” is selected as the standard on page 1 (Figure 8-1).

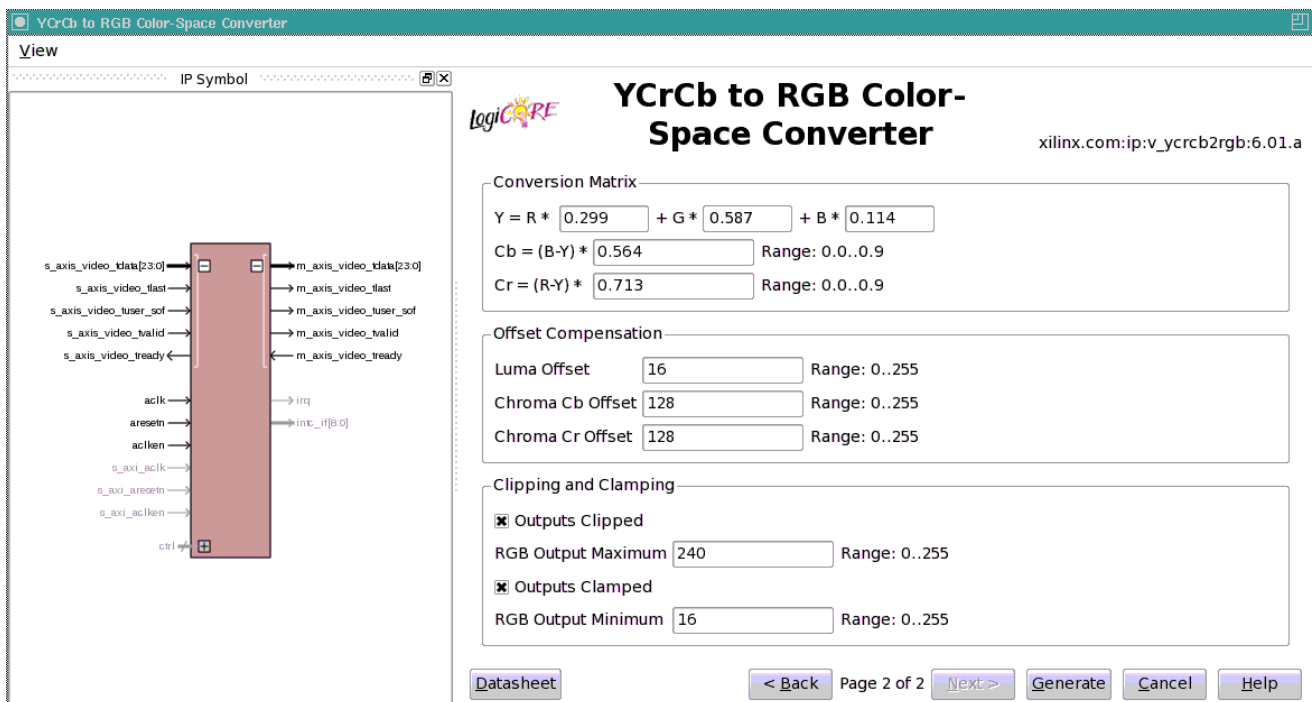

Figure 8-2: Conversion Matrix, Offset Compensation, Clipping and Clamping Screen

- **Conversion Matrix:** Enter floating-point conversion constants, ranging from 0 to 1, into the four fields representing CA, CB, CC and CD.
- **Offset Compensation:** Enter the offset compensation constants ( $O_Y$ ,  $O_{Cb}$ , and  $O_{Cr}$  in Equation 3-17, Equation 3-18 and Equation 3-19). These constants are scaled to the output representation. If  $O_Y$ ,  $O_{Cb}$ , and  $O_{Cr}$  are in the 0.0 - 1.0 range, and the output is



represented as 10-bit unsigned integers, then luminance and chrominance offsets should be entered as integers in the 0 - 1023 range.

- **Outputs Clipped/Outputs Clamped:** These check boxes control whether clipping/clamping logic will be instantiated in the generated netlist. The clipping/clamping logic ensures no arithmetic wrap-arounds happen at overflows, at the expense of extra slice-based logic resources.
- **Minimum and Maximum Values:** Similar to offset values, the edit boxes take unsigned integer values in the range permitted by the current output representation.

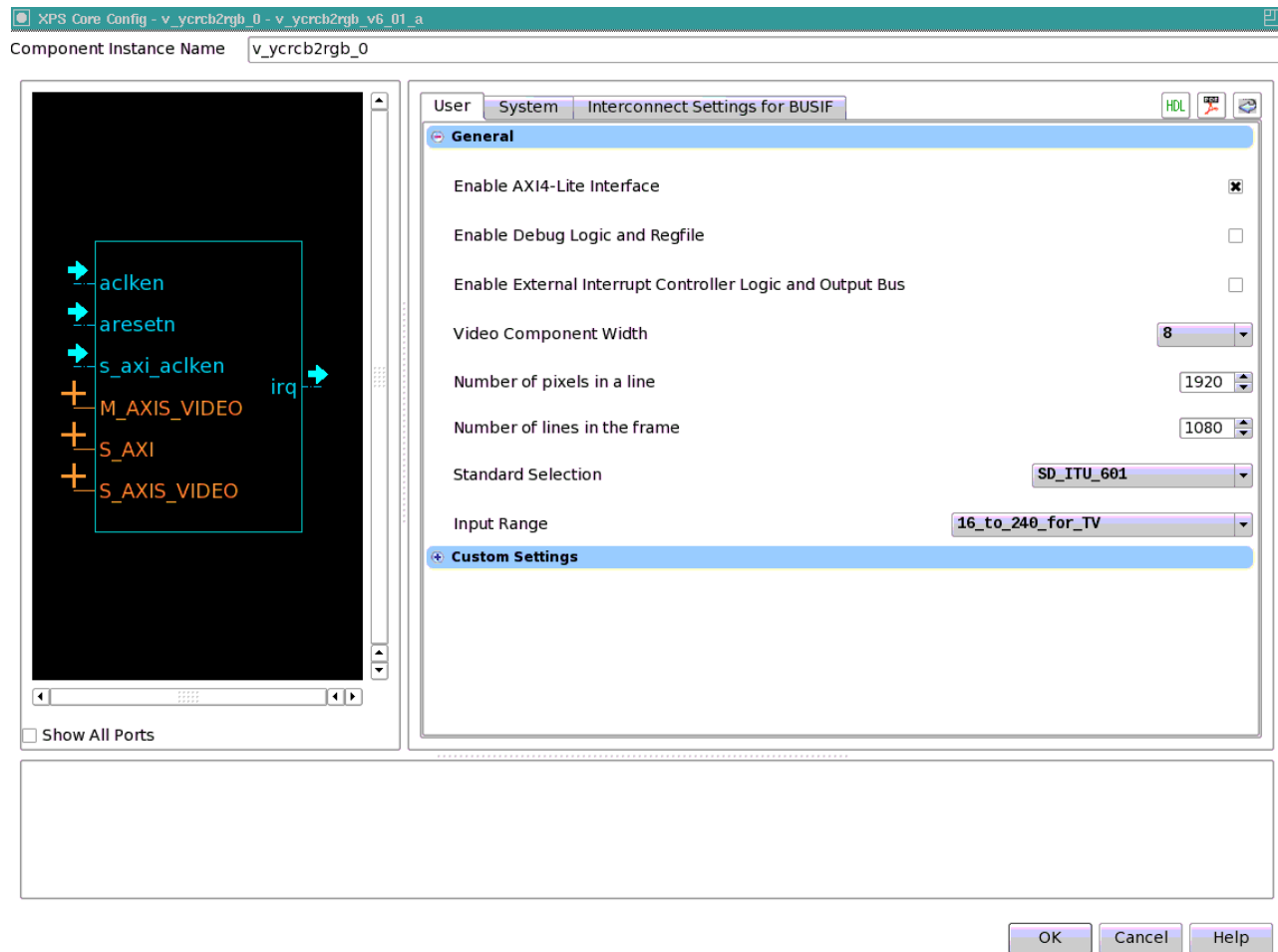

Figure 8-3: EDK GUI Screen with Default Setting

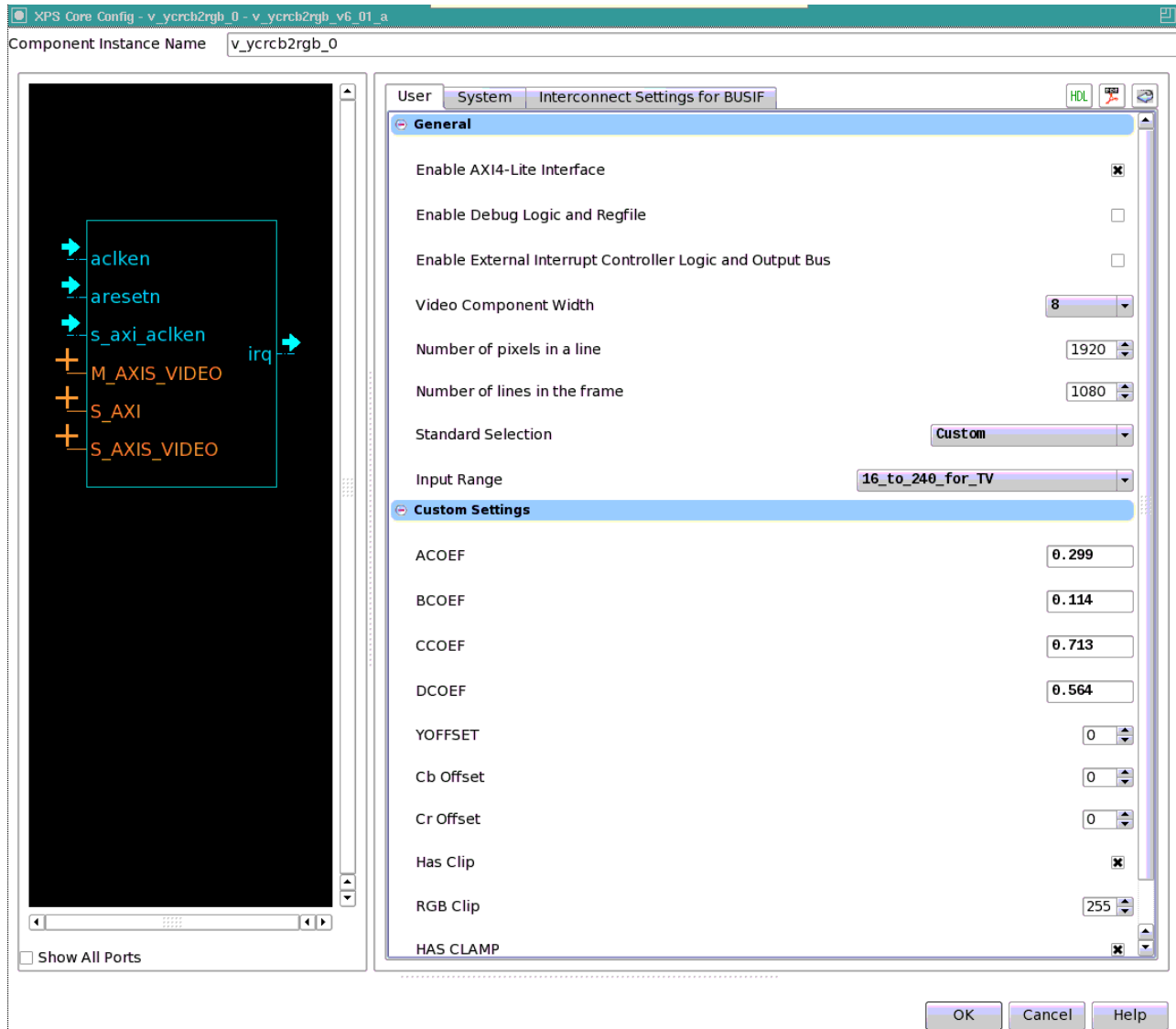

Figure 8-4: EDK GUI Screen with Custom Setting

Definitions of the EDK GUI controls are identical to the corresponding CORE Generator GUI functions.

## Parameter Values in the XCO File

Table 8-1 defines valid entries for the XCO parameters. Xilinx strongly suggests that XCO parameters are not manually edited in the XCO file; instead, use the CORE Generator software GUI to configure the core and perform range and parameter value checking. The XCO parameters are helpful in defining the interface to other Xilinx tools.

Table 8-1: XCO Parameters

XCO Parameter	Default Values
component_name	v_ycrCb2rgb_v6_00_a
s_axis_video_data_width	8
m_axis_video_data_width	8
acoef	0.299
bcoef	0.114
ccoef	0.713
dcoef	0.564
rgbmin	16
rgbmax	240
cboffset	128
croffset	128
yoffset	16
has_clamp	true
has_clip	true
input_range	16_to_240_for TV
standard_sel	SD_ITU_601
has_axi4_lite	false
has_debug	false
has_intc_if	false
active_cols	1920
active_rows	1080

---

## Output Generation

CORE Generator will output the core as a netlist that can be inserted into a processor interface wrapper or instantiated directly in an HDL design. The output is placed in the <project director>.

## File Details

The CORE Generator output consists of some or all the following files.

Name	Description
<component_name>_readme.txt	Readme file for the core.
<component_name>.ngc	The netlist for the core.
<component_name>.veo	The HDL template for instantiating the core.
<component_name>.vho	
<component_name>.v	The structural simulation model for the core. It is used for functionally simulating the core.
<component_name>.vhd	
<component_name>.xco	Log file from CORE Generator software describing which options were used to generate the core. An XCO file can also be used as an input to the CORE Generator software.

# Constraining the Core

---

## Required Constraints

The `ACLK` pin should be constrained at the desired pixel clock rate for your video stream.

The `S_AXI_ACLK` pin should be constrained at the frequency of the AXI4-Lite subsystem.

In addition to clock frequency, the following constraints should be applied to cover all clock domain crossing data paths.

### UCF

```
INST "*U_VIDEO_CTRL*/*SYNC2PROCCLK_I*/data_sync_reg[0]*" TNM =
"async_clock_conv_FFDEST";
TIMESPEC "TS_async_clock_conv" = FROM FFS TO "async_clock_conv_FFDEST" 2 NS
DATAPATHONLY;
INST "*U_VIDEO_CTRLk*/*SYNC2VIDCLK_I*/data_sync_reg[0]*" TNM =
"vid_async_clock_conv_FFDEST";
TIMESPEC "TS_vid_async_clock_conv" = FROM FFS TO "vid_async_clock_conv_FFDEST" 2 NS
DATAPATHONLY;
```

### XDC

```
set_max_delay -to [get_cells -hierarchical -match_style ucf "*U_VIDEO_CTRL*/
*SYNC2PROCCLK_I*/data_sync_reg[0]*"] -datapath_only 2

set_max_delay -to [get_cells -hierarchical -match_style ucf "*U_VIDEO_CTRL*/
*SYNC2VIDCLK_I*/data_sync_reg[0]*"] -datapath_only 2
```

---

## Device, Package, and Speed Grade Selections

There are no device, package, or speed grade requirements for this core. For a complete listing of supported devices, see the release notes for this core.

---

## Clock Frequencies

The pixel clock (`ACLK`) frequency is the required frequency for the Color Filter Array Interpolation core. See [Maximum Frequencies in Chapter 2](#). The `S_AXI_ACLK` maximum frequency is the same as the `ACLK` maximum.

---

## Clock Management

The core automatically handles clock domain crossing between the `ACLK` (video pixel clock and AXI4-Stream) and the `S_AXI_ACLK` (AXI4-Lite) clock domains. The `S_AXI_ACLK` clock can be slower or faster than the `ACLK` clock signal, but must not be more than 128x faster than `ACLK`.

---

## Clock Placement

There are no specific Clock placement requirements for this core.

---

## Banking

There are no specific Banking rules for this core.

---

## Transceiver Placement

There are no Transceiver Placement requirements for this core.

---

## I/O Standard and Placement

There are no specific I/O standards and placement requirements for this core.

# Detailed Example Design

No example design is available at the time for the LogiCORE IP YCrCb to RGB Color-Space Converter v6.01a core.

---

## Demonstration Test Bench

A demonstration test bench is provided which enables core users to observe core behavior in a typical use scenario. The user is encouraged to make simple modifications to the test conditions and observe the changes in the waveform.

---

## Test Bench Structure

The top-level entity, `tb_main.v`, instantiates the following modules:

- DUT  
The YCrCb2RGB v6.01.a core instance under test.
- `axi4lite_mst`  
The AXI4-Lite master module, which initiates AXI4-Lite transactions to program core registers.
- `axi4s_video_mst`  
The AXI4-Stream master module, which opens the stimuli txt file and initiates AXI4-Stream transactions to provide stimuli data for the core
- `axi4s_video_slv`  
The AXI4-Stream slave module, which opens the result txt file and verifies AXI4-Stream transactions from the core
- `ce_gen`  
Programmable Clock Enable (`ACLKEN`) generator

---

## Running the Simulation

- Simulation using ModelSim for Linux:  
From the console, Type "source run\_mti.sh".
- Simulation using ModelSim for Windows:  
Double-click on "run\_mti.bat" file.
- Simulation using iSim:  
Double-click on "run\_isim.bat" file.

---

## Directory and File Contents

The directory structure underneath the top-level folder is:

- **expected:**  
Contains the pre-generated expected/golden data used by the testbench to compare actual output data.
- **stimuli:**  
Contains the pre-generated input data used by the testbench to stimulate the core (including register programming values).
- **Results:**  
Actual output data will be written to a file in this folder.
- **Src:**  
Contains the .vhd simulation files and the .xco CORE Generator parameterization file of the core instance. The .vhd file is a netlist generated using CORE Generator. The .xco file can be used to regenerate a new netlist using CORE Generator.

The available core C-model can be used to generate stimuli and expected results for any user bmp image. For more information, refer to [Chapter 4, C Model Reference](#).

The top-level directory contains packages and Verilog modules used by the test bench, as well as:

- **isim\_wave.wcfg:**  
Waveform configuration for ISIM
- **mti\_wave.do:**  
Waveform configuration for ModelSim
- **run\_isim.bat :**  
Runscript for iSim in Windows



- run\_isim.sh:  
Runscript for iSim in Linux
- run\_mti.bat:  
Runscript for ModelSim in Windows
- run\_mti.sh:  
Runscript for ModelSim in Linux

## SECTION IV: APPENDICES

Verification, Compliance, and Interoperability

Migrating

Debugging

Application Software Development

Additional Resources

# Verification, Compliance, and Interoperability

---

## Simulation

A highly parameterizable test bench was used to test the YCrCb to RGB Color-Space Converter core. Testing included the following:

- Register accesses
  - Processing multiple frames of data
  - AXI4-Stream bidirectional data-throttling tests
  - Testing detection, and recovery from various AXI4-Stream framing error scenarios
  - Testing different `ACLKEN` and `ARESETn` assertion scenarios
  - Testing of various frame sizes
  - Varying parameter settings
- 

## Hardware Testing

The YCrCb to RGB Color-Space Converter core has been validated in hardware at Xilinx to represent a variety of parameterizations, including the following:

- A test design was developed for the core that incorporated a MicroBlaze™ processor, AXI4-Lite interconnect and various other peripherals. The software for the test system included pre-generated input and output data along with live video stream. The MicroBlaze processor was responsible for:
  - Initializing the appropriate input and output buffers
  - Initializing the YCrCb to RGB Color-Space Converter core
  - Launching the test
  - Comparing the output of the core against the expected results

- Reporting the Pass/Fail status of the test and any errors that were found

---

## Interoperability

The core slave (input) AXI4-Stream interface can work directly with any Video core which produces YCrCb (or YUV) 4:4:4 video data on an AXI4-Stream interface with a Video Protocol. The core master (output) RGB interface can work directly with any Video core which consumes RGB data on an AXI4-Stream interface with a Video Protocol.

# Migrating

For information about migration from ISE Design Suite to Vivado Design Suite, see *Vivado Design Suite Migration Methodology Guide* (UG911) [Ref 8].

For a complete list of Vivado User and Methodology Guides, see the [Vivado Design Suite - 2012.3 User Guides](#).

The core previously had `aclk`, `aclken`, and `aresetn` to control the Video over AXI4-Stream and AXI4-Lite interfaces. Currently, separate clock, clock enable, and reset pins control the Video over AXI4-Stream and the AXI4-Lite interfaces with clock domain crossing logic added to the core to handle the heterogenous clock domains between the AXI4-Lite and Video over AXI4-Stream domains.

From v6.00.a to v6.01.a of the YCrCb2RGB core, the following changes take place:

- Demonstration testbench included in Vivado
- Added support for 14.3 ISE, Vivado and

# Debugging

It is recommended to prototype the system with the AXI4-Stream interface enabled, so status and error detection, reset, and dynamic size programming can be used during debugging.

The following steps are recommended to bring-up/debug the core in a video/imaging system:

1. Bring up the AXI4-Lite interface
2. Bring up the AXI4-Stream interfaces

Once the core is working as expected, the user may consider 'hardening' the configuration by replacing the YCrCb2RGB core with an instance where GUI default values used for the register values, and the AXI4-Lite interface is disabled. This configuration reduces the core slice footprint.

## Bringing up the AXI4-Lite Interface

Table C-1 describes how to troubleshoot the AXI4-Lite interface.

Table C-1: Troubleshooting the AXI4-Lite Interface

Symptom	Solution
Readback from the Version Register via the AXI4-Lite interface times out, or a core instance without an AXI4-Lite interface seems non-responsive.	Are the S_AXI_ACLK and ACLK pins connected? In EDK, verify that the S_AXI_ACLK and ACLK pin connections in the system.mhs file. The VERSION_REGISTER readout issue may be indicative of the core not receiving the AXI4-Lite interface.
Readback from the Version Register via the AXI4-Lite interface times out, or a core instance without an AXI4-Lite interface seems non-responsive.	Is the core enabled? Is s_axi_aclken connected to vcc? In EDK, verify that signal ACLKEN is connected in the <b>system.mhs</b> to either net_vcc or to a designated clock enable signal.

**Table C-1: Troubleshooting the AXI4-Lite Interface (Cont'd)**

Symptom	Solution
Readback from the Version Register via the AXI4-Lite interface times out, or a core instance without an AXI4-Lite interface seems non-responsive.	Is the core in reset? S_AXI_ARESETn and ARESETn should be connected to vcc for the core not to be in reset. In EDK, verify that the S_AXI_ARESETn and ARESETn signals are connected in the <b>system.mhs</b> to either net_vcc or to a designated reset signal.
Readback value for the VERSION_REGISTER is different from expected default values	The core and/or the driver in a legacy EDK/SDK project has not been updated. Ensure that old core versions, implementation files, and implementation caches have been cleared.

Assuming the AXI4-Lite interface works, the second step is to bring up the AXI4-Stream interfaces.

## Bringing up the AXI4-Stream Interfaces

Table C-2 describes how to troubleshoot the AXI4-Lite interface.

**Table C-2: Troubleshooting AXI4-Stream Interface**

Symptom	Solution
Bit 0 of the ERROR register reads back set.	Bit 0 of the ERROR register, EOL_EARLY, indicates the number of pixels received between the latest and the preceding End-Of-Line (EOL) signal was less than the value programmed into the ACTIVE_SIZE register. If the value was provided by the Video Timing Controller core, read out ACTIVE_SIZE register value from the VTC core again, and make sure that the TIMING_LOCKED flag is set in the VTC core. Otherwise, using Chipscope, measure the number of active AXI4-Stream transactions between EOL pulses.
Bit 1 of the ERROR register reads back set.	Bit 1 of the ERROR register, EOL_LATE, indicates the number of pixels received between the last End-Of-Line (EOL) signal surpassed the value programmed into the ACTIVE_SIZE register. If the value was provided by the Video Timing Controller core, read out ACTIVE_SIZE register value from the VTC core again, and make sure that the TIMING_LOCKED flag is set in the VTC core. Otherwise, using Chipscope, measure the number of active AXI4-Stream transactions between EOL pulses.
Bit 2 or Bit 3 of the ERROR register reads back set.	Bit 2 of the ERROR register, SOF_EARLY, and bit 3 of the ERROR register SOF_LATE indicate the number of pixels received between the latest and the preceding Start-Of-Frame (SOF) differ from the value programmed into the ACTIVE_SIZE register. If the value was provided by the Video Timing Controller core, read out ACTIVE_SIZE register value from the VTC core again, and make sure that the TIMING_LOCKED flag is set in the VTC core. Otherwise, using Chipscope, measure the number EOL pulses between subsequent SOF pulses.

Table C-2: Troubleshooting AXI4-Stream Interface

Symptom	Solution
s_axis_video_tready stuck low, the upstream core cannot send data.	During initialization, line-, and frame-flushing, the YCrCb2RGB core keeps its s_axis_video_tready input low. Afterwards, the core should assert s_axis_video_tready automatically. Is m_axis_video_tready low? If so, the YCrCb2RGB core cannot send data downstream, and the internal FIFOs are full.
m_axis_video_tvalid stuck low, the downstream core is not receiving data	<ol style="list-style-type: none"> <li>No data is generated during the first two lines of processing.</li> <li>If the programmed active number of pixels per line is radically smaller than the actual line length, the core drops most of the pixels waiting for the (s_axis_video_tlast) End-of-line signal. Check the ERROR register.</li> </ol>
Generated SOF signal (m_axis_video_tuser0) signal misplaced.	Check the ERROR register.
Generated EOL signal (m_axis_video_tlast) signal misplaced.	Check the ERROR register.
Data samples lost between Upstream core and the YCrCb2RGB core. Inconsistent EOL and/or SOF periods received.	<ol style="list-style-type: none"> <li>Are the Master and Slave AXI4-Stream interfaces in the same clock domain?</li> <li>Is proper clock-domain crossing logic instantiated between the upstream core and the YCrCb2RGB core (Asynchronous FIFO)?</li> <li>Did the design meet timing?</li> <li>Is the frequency of the clock source driving the YCrCb2RGB ACLK pin lower than the reported Fmax reached?</li> </ol>
Data samples lost between Downstream core and the YCrCb2RGB core. Inconsistent EOL and/or SOF periods received.	<ol style="list-style-type: none"> <li>Are the Master and Slave AXI4-Stream interfaces in the same clock domain?</li> <li>Is proper clock-domain crossing logic instantiated between the upstream core and the YCrCb2RGB core (Asynchronous FIFO)?</li> <li>Did the design meet timing?</li> <li>Is the frequency of the clock source driving the YCrCb2RGB ACLK pin lower than the reported Fmax reached?</li> </ol>

If the AXI4-Stream communication is healthy, but the data seems corrupted, the next step is to find the correct configuration for the YCrCb2RGB core.



---

## Debugging Features

The YCrCb2RGB core is equipped with optional debugging features which aim to accelerate system bring-up, optimize memory and data-path architecture and reduce time to market. The optional debug features can be turned on/off via the **Include Debug Features** checkbox on the GUI when an AXI4-Lite interface is present. Turning off debug features reduces the core Slice footprint.

### Core Bypass Option

The bypass option facilitates establishing a straight through connection between input (AXI4-Stream slave) and output (AXI4-Stream master) interfaces bypassing any processing functionality.

Flag BYPASS (bit 4 of the CONTROL register) can turn bypass on (1) or off, when the core instance Debugging Features were enabled at generation. Within the IP this switch controls multiplexers in the AXI4-Stream path.

In bypass mode the YCrCb2RGB core processing function is bypassed, and the core repeats AXI4-Stream input samples on its output. In bypass mode, the Y channel is presented on the Green channel, Cr is presented on the Red channel and Cb is presented on the Blue channel.

Starting a system with all processing cores set to bypass, then by turning bypass off from the system input towards the system output allows verification of subsequent cores with known good stimuli.

### Built in Test-Pattern Generator

The optional built-in test-pattern generator facilitates to temporarily feed the output AXI4-Stream master interface with a predefined pattern.

Flag TEST\_PATTERN (bit 5 of the CONTROL register) can turn test-pattern generation on (1) or off, when the core instance Debugging Features were enabled at generation. Within the IP this switch controls multiplexers in the AXI4-Stream path, switching between the regular core processing output and the test-pattern generator. When enabled, a set of counters generate 256 scan-lines of color-bars, each color bar 64 pixels wide, repetitively cycling through Black, Red, Green, Yellow, Blue, Magenta, Cyan, and White colors till the end of each scan-line. After the Color-Bars segment, the rest of the frame is filled with a monochrome horizontal and vertical ramp.

Starting a system with all processing cores set to test-pattern mode, then by turning test-pattern generation off from the system output towards the system input allows successive bring-up and parameterization of subsequent cores.

## Throughput Monitors

Throughput monitors enable the user to monitor processing performance within the core. This information can be used to help debug frame-buffer bandwidth limitation issues, and if possible, allow video application software to balance memory pathways.

Often times video systems, with multiport access to a shared external memory, have different processing islands. For example a pre-processing sub-system working in the input video clock domain may clean up, transform, and write a video stream, or multiple video streams, to memory. The processing sub-system may read the frames out, process, scale, encode, then write frames back to the frame buffer, in a separate processing clock domain. Finally, the output sub-system may format the data and read out frames locked to an external clock.

Typically, access to external memory using a multiport memory controller involves arbitration between competing streams. However, to maximize the throughput of the system, different memory ports may need different specific priorities. To fine tune the arbitration and dynamically balance frame rates, it is beneficial to have access to throughput information measured in different video data paths.

The SYSDEBUG0 (0x0014), or Frame Throughput Monitor, register indicates the number of frames processed since power-up or the last time the core was reset. The SYSDEBUG1 (0x0018), or Line Throughput Monitor, register indicates the number of lines processed since power-up or the last time the core was reset. The SYSDEBUG2 (0x001C), or Pixel Throughput Monitor, register indicates the number of pixels processed since power-up or the last time the core was reset.

Priorities of memory access points can be modified by the application software dynamically to equalize frame, or partial frame rates.

---

## Interfacing to Third-Party IP

[Table C-3](#) describes how to troubleshoot third-party interfaces.

Table C-3: Troubleshooting Third-Party Interfaces

Symptom	Solution
<p>Severe color distortion or color-swap when interfacing to third-party video IP.</p>	<p>Verify that the color component logical addressing on the AXI4-Stream TDATA signal is in according to <a href="#">Data Interface in Chapter 2</a>. If misaligned:                      In HDL, break up the TDATA vector to constituent components and manually connect the slave and master interface sides.                      In EDK, create a new vector for the slave side TDATA connection. In the MPD file, manually assign components of the master-side TDATA vector to sections of the new vector.</p>
<p>Severe color distortion or color-swap when processing video written to external memory using the AXI-VDMA core.</p>	<p>Unless the particular software driver was developed with the AXI4-Stream TDATA signal color component assignments described in <a href="#">Data Interface in Chapter 2</a> in mind, there are no guarantees that the software will correctly identify bits corresponding to color components.                      Verify that the color component logical addressing TDATA is in alignment with the data format expected by the software drivers reading/writing external memory. If misaligned:                      In HDL, break up the TDATA vector to constituent components, and manually connect the slave and master interface sides.                      In EDK, create a new vector for the slave side TDATA connection. In the MPD file, manually assign components of the master-side TDATA vector to sections of the new vector.</p>

# Application Software Development

## Programmer Guide

The software API is provided to allow easy access to the YCrCb2RGB AXI4-Lite registers defined in [Table 2-12](#). To utilize the API functions, the following two header files must be included in the user C code:

```
#include "ycrcb2rgb.h"
#include "xparameters.h"
```

The hardware settings of your system, including the base address of your YCrCb2RGB core, are defined in the `xparameters.h` file. The `ycrcb2rgb.h` file contains the macro function definitions for controlling the YCrCb2RGB pCore.

For examples on API function calls and integration into a user application, the `drivers` subdirectory of the pCore contains a file, `example.c`, in the `ycrcb2rgb_v6_01_a0_a/example` subfolder. This file is a sample C program that demonstrates how to use the YCrCb2RGB pCore API.

Table D-1: YCrCb2RGB Driver Function Definitions

Function Name and Parameterization	Description
YCC_Enable (uint32 BaseAddress)	Enables a YCrCb2RGB instance.
YCC_Disable (uint32 BaseAddress)	Disables a YCrCb2RGB instance.
YCC_Reset (uint32 BaseAddress)	Immediately resets a YCrCb2RGB instance. The core stays in reset until the RESET flag is cleared.
YCC_ClearReset (uint32 BaseAddress)	Clears the reset flag of the core, which allows it to re-sync with the input video stream and return to normal operation.
YCC_AutoSyncReset (uint32 BaseAddress)	Resets a YCrCb2RGB instance at the end of the current frame being processed, or immediately if the core is not currently processing a frame.
YCC_ReadReg (uint32 BaseAddress, uint32 RegOffset)	Returns the 32-bit unsigned integer value of the register. Read the register selected by RegOffset (defined in <a href="#">Table 2-12</a> ).

Table D-1: YCrCb2RGB Driver Function Definitions (Cont'd)

Function Name and Parameterization	Description
YCC_WriteReg (uint32 BaseAddress, uint32 RegOffset, uint32 Data)	Write the register selected by RegOffset (defined in Table 2-12. Data is the 32-bit value to write to the register.
YCC_RegUpdateEnable (uint32 BaseAddress)	Enables copying double buffered registers at the beginning of the next frame. Refer to Double Buffering for more information.
YCC_RegUpdateDisable (uint32 BaseAddress)	Disables copying double buffered registers at the beginning of the next frame. Refer to Double Buffering for more information.
YCC_select_standard (int standard_sel, int input_range, struct ycc_coef_inputs *coef_in)	Populates an rgb_coef_inputs structure with the values from the selected Video standard standard_sel 0 = SD_ITU_601 1 = HD_ITU_709_1125_NTSC 2 = HD_ITU_709_1250_PAL 3 = YUV input_range 0 = 16_to_240_for_TV, 1 = 16_to_235_for_Studio_Equipment 2 = 0_to_255_for_Computer_Graphics
YCC_coefficient_translation (struct ycc_coef_inputs *coef_in, struct ycc_coef_outputs *coef_out)	Translates the ycc_coef_inputs structure into the ycc_coef_outputs structure that can be used to program the core's registers. The ycc_coef_inputs structure uses the same values as the core's GUIs. The ycc_coef_outputs structure uses the values that can be programmed into the core's registers.
void YCC_set_coefficients (Xuint32 BaseAddress, struct ycc_coef_outputs *coef_out)	Writes the translated coefficient values to the core's registers.
void YCC_get_coefficients (Xuint32 BaseAddress, struct ycc_coef_outputs *coef_out)	Reads the translated coefficient values from the core's registers.

## Software Reset

Software reset reinitializes registers of the AXI4-Lite control interface to their initial value, resets FIFOs, forces `m_axis_video_tvalid` and `s_axis_video_tready` to 0. `YCC_Reset()` and `YCC_AutoSyncReset()` reset the core immediately if the core is not currently processing a frame. If the core is currently processing a frame calling `YCC_Reset()`, or setting bit 30 of the `CONTROL` register to 1 will cause image tearing. After calling `YCC_Reset()`, the core remains in reset until `YCC_ClearReset()` is called.

Calling `YCC_AutoSyncReset()` automates this reset process by waiting until the core finishes processing the current frame, then asserting the reset signal internally, keeping the core in reset only for 32 `ACLK` cycles, then deasserting the signal automatically. After calling `YCC_AutoSyncReset()`, it is not necessary to call `YCC_ClearReset()` for the core to return to normal operating mode.



**IMPORTANT:** Calling `YCC_AutoSyncReset()` does not guarantee prompt, or real-time resetting of the core. If the AXI4-Stream communication is halted mid frame, the core will not reset until the upstream core finishes sending the current frame or starts a new frame.

## Double Buffering

The `ACTIVE_SIZE` and the core specific registers are double-buffered to ensure no image tearing happens if values are modified during frame processing. Values from the AXI4-Lite interface are latched into processor registers immediately after writing, and processor register values are copied into the active register set at the Start Of Frame (SOF) signal. Double-buffering decouples AXI4-Lite register updates from the AXI4-Stream processing, allowing software a large window of opportunity to update processing parameter values without image tearing.

If multiple register values are changed during frame processing, simple double buffering would not guarantee that all register updates would take effect at the beginning of the same frame. Using a semaphore mechanism, the `RegUpdateEnable()` and `RegUpdateDisable()` functions allows synchronous commitment of register changes. The YCrCb2RGB core will start using the updated `ACTIVE_SIZE` and register values only if the `REGUPDATE` flag of the `CONTROL` register is set (1), after the next Start-Of-Frame signal (`s_axis_video_tuser0`) is received. Therefore, it is recommended to disable the register update before writing multiple double-buffered registers, then enable register update when register writes are completed.

## Reading and Writing Registers

Each software register that is defined in [Table 2-12](#) has a constant that is defined in `yccrb2rgb.h` which is set to the offset for that register listed in [Table D-2](#). It is recommended that the application software uses the predefined register names instead of register values when accessing core registers, so future updates to the YCrCb2RGB drivers which may change register locations will not affect the application dependent on the YCrCb2RGB driver.

Table D-2: Predefined Constants Defined in `yccrb2rgb.h`

Constant Name Definition	Value	Target Register
<code>YCC_CONTROL</code>	0x0000	<code>CONTROL</code>
<code>YCC_STATUS</code>	0x0004	<code>STATUS</code>
<code>YCC_ERROR</code>	0x0008	<code>ERROR</code>
<code>YCC_IRQ_ENABLE</code>	0x000C	<code>IRQ_ENABLE</code>
<code>YCC_VERSION</code>	0x0010	<code>VERSION</code>
<code>YCC_SYSDEBUG0</code>	0x0014	<code>SYSDEBUG0</code>
<code>YCC_SYSDEBUG1</code>	0x0018	<code>SYSDEBUG1</code>

Table D-2: Predefined Constants Defined in ycrb2rgb.h (Cont'd)

Constant Name Definition	Value	Target Register
YCC_SYSDEBUG2	0x001C	SYSDEBUG2
YCC_ACTIVE_SIZE	0x0020	ACTIVE_SIZE
YCC_RGBMAX	0x100	YMAX
YCC_RGBMIN	0x104	YMIN
YCC_ROFFSET	0x108	YOFFSET
YCC_GOFFSET	0x10C	CBOFFSET
YCC_BOFFSET	0x110	CROFFSET
YCC_ACOEF	0x114	ACOEf
YCC_BCOEF	0x118	BCOEf
YCC_CCOEF	0x11C	CCOEf
YCC_DCOEF	0x120	DCOEF

# Additional Resources

---

## Xilinx Resources

For support resources such as Answers, Documentation, Downloads, and Forums, see the Xilinx Support website at:

<http://www.xilinx.com/support>.

For a glossary of technical terms used in Xilinx documentation, see:

[http://www.xilinx.com/support/documentation/sw\\_manuals/glossary.pdf](http://www.xilinx.com/support/documentation/sw_manuals/glossary.pdf).

For a comprehensive listing of Video and Imaging application notes, white papers, reference designs and related IP cores, see the Video and Imaging Resources page at:

[http://www.xilinx.com/esp/video/refdes\\_listing.htm#ref\\_des](http://www.xilinx.com/esp/video/refdes_listing.htm#ref_des).

---

## Solution Centers

See the [Xilinx Solution Centers](#) for support on devices, software tools, and intellectual property at all stages of the design cycle. Topics include design assistance, advisories, and troubleshooting tips.

---

## References

These documents provide supplemental material useful with this user guide:

1. Jack, Keith. 2004. Video Demystified, 4th Edition. Burlington, MA: Newnes: pp 15-19.
2. Poynton, Charles. 2003. Digital Video and HDTV. San Francisco: Morgan Kaufmann: pp 302- 321.
3. ITU Recommendation BT.601-5, International Telecommunication Union, 1995.
4. ITU Recommendation BT.709-5, International Telecommunication Union, 2002.



5. Proakis, John G., and Dimitris G. Manolakis. Digital Signal Processing, 3rd edition. Upper Saddle River, NJ: Prentice Hall: pp 755-756.
6. Sullivan, Gary. 2003. Approximate theoretical analysis of RGB to YCbCr to RGB conversion error. Presented for Joint Video Team (JVT) of ISO/IEC MPEG & ITU-T VCEG (ISO/IEC
7. JTC1/SC29/WG11 and ITU-T SG16 Q.6), July 22-24, in Trondhe
8. [Vivado Design Suite Migration Methodology Guide](#) (UG911)
9. [Vivado™ Design Suite user documentation](#)
10. [UG761 AXI Reference Guide](#)

## Technical Support

Xilinx provides technical support at [www.xilinx.com/support](http://www.xilinx.com/support) for this LogiCORE™ IP product when used as described in the product documentation. Xilinx cannot guarantee timing, functionality, or support of product if implemented in devices that are not defined in the documentation, if customized beyond that allowed in the product documentation, or if changes are made to any section of the design labeled DO NOT MODIFY.

See the IP Release Notes Guide ([XTP025](#)) for more information on this core. For each core, there is a master Answer Record that contains the Release Notes and Known Issues list for the core being used. The following information is listed for each version of the core:

- New Features
- Resolved Issues
- Known Issues

## Revision History

The following table shows the revision history for this document.

Date	Version	Revision
10/19/2011	1.0	Initial Xilinx release of Product Guide, replacing DS659 and UG833.
4/24/2012	2.0	Updated for core version. Added Zynq-7000 devices, added AXI4-Stream interfaces, deprecated GPP interface.
07/25/2012	3.0	Updated for core version. Added Vivado information.
10/16/2012	3.1	Updated for core version. Added Vivado test bench.

---

## Notice of Disclaimer

The information disclosed to you hereunder (the "Materials") is provided solely for the selection and use of Xilinx products. To the maximum extent permitted by applicable law: (1) Materials are made available "AS IS" and with all faults, Xilinx hereby DISCLAIMS ALL WARRANTIES AND CONDITIONS, EXPRESS, IMPLIED, OR STATUTORY, INCLUDING BUT NOT LIMITED TO WARRANTIES OF MERCHANTABILITY, NON-INFRINGEMENT, OR FITNESS FOR ANY PARTICULAR PURPOSE; and (2) Xilinx shall not be liable (whether in contract or tort, including negligence, or under any other theory of liability) for any loss or damage of any kind or nature related to, arising under, or in connection with, the Materials (including your use of the Materials), including for any direct, indirect, special, incidental, or consequential loss or damage (including loss of data, profits, goodwill, or any type of loss or damage suffered as a result of any action brought by a third party) even if such damage or loss was reasonably foreseeable or Xilinx had been advised of the possibility of the same. Xilinx assumes no obligation to correct any errors contained in the Materials or to notify you of updates to the Materials or to product specifications. You may not reproduce, modify, distribute, or publicly display the Materials without prior written consent. Certain products are subject to the terms and conditions of the Limited Warranties which can be viewed at <http://www.xilinx.com/warranty.htm>; IP cores may be subject to warranty and support terms contained in a license issued to you by Xilinx. Xilinx products are not designed or intended to be fail-safe or for use in any application requiring fail-safe performance; you assume sole risk and liability for use of Xilinx products in Critical Applications: <http://www.xilinx.com/warranty.htm#critapps>.

© Copyright 2011–2012 Xilinx, Inc. Xilinx, the Xilinx logo, Artix, ISE, Kintex, Spartan, Virtex, Zynq, and other designated brands included herein are trademarks of Xilinx in the United States and other countries. All other trademarks are the property of their respective owners.