

# Gamma Correction v7.0

## *LogiCORE IP Product Guide*

PG004 November 18, 2015

Discontinued IP

# Table of Contents

## IP Facts

### Chapter 1: Overview

Feature Summary .....	6
Applications .....	6
Licensing and Ordering Information .....	7

### Chapter 2: Product Specification

Standards .....	8
Performance .....	8
Resource Utilization .....	9
Core Interfaces and Register Space .....	10

### Chapter 3: Designing with the Core

General Design Guidelines .....	24
Clock, Enable, and Reset Considerations .....	25
System Considerations .....	27

### Chapter 4: Customizing and Generating the Core

Vivado Integrated Design Environment .....	31
Interface .....	31

### Chapter 5: Constraining the Core

Required Constraints .....	36
----------------------------	----

### Chapter 6: C Model Reference

Features .....	37
Overview .....	37
Using the C Model .....	39
C-Model Example Code .....	44

**Chapter 7: Simulation**

**Chapter 8: Synthesis and Implementation**

**Chapter 9: Detailed Example Design**

**Chapter 10: Test Bench**

Demonstration Test Bench ..... 49

**Appendix A: Verification, Compliance, and Interoperability**

Simulation ..... 51  
 Hardware Testing ..... 51  
 Interoperability ..... 52

**Appendix B: Migrating and Upgrading**

Migrating to the Vivado Design Suite ..... 53  
 Upgrading in Vivado Design Suite ..... 53

**Appendix C: Debugging**

Finding Help on Xilinx.com ..... 54  
 Debug Tools ..... 55  
 Hardware Debug ..... 56  
 Interface Debug ..... 58  
 ..... 61

**Appendix D: Additional Resources**

Xilinx Resources ..... 62  
 References ..... 62  
 Revision History ..... 63  
 Notice of Disclaimer ..... 63

## Introduction

The Xilinx LogiCORE™ IP Gamma Correction core provides customers with an optimized hardware block for manipulating image data to match the response of display devices. This core is implemented using a look-up table structure that is programmed to implement a gamma correction curve transform on the input image data. Programmable number of gamma tables enable having separate gamma tables for all color channels, separate tables for luminance and chrominance channels, or one gamma table to be shared by all color channels.

## Features

- Programmable gamma table supports gamma correction or any user defined function
- One, two or three channel independent or shared look-up table structure allow potential resource reduction
- AXI4-Stream data interfaces
- Supports 8, 10 and 12-bits per color component input and output
- Supports spatial resolutions from 32x32 up to 7680x7680
  - Supports 1080P60 in all supported device families <sup>(1)</sup>
  - Supports 4kx2k at the 24Hz in supported high performance devices
- Optional features:
  - Interpolated output values for 12-bit data to reduce resource requirements
  - AXI4-Lite Control interface allowing real-time re-programming of gamma tables
  - Double buffering of control interface to prevent image tearing
  - Built-in throughput monitors to assist with system optimization
  - Bypass and test pattern generator mode to assist with system bring up and debug

1. Performance on low power devices may be lower.

LogiCORE IP Facts Table	
<b>Core Specifics</b>	
Supported Device Family <sup>(1)</sup>	UltraScale+™ Families, UltraScale™ Architecture, Zynq®-7000, 7 Series
Supported User Interfaces	AXI4-Lite, AXI4-Stream <sup>(2)</sup>
Resources	See <a href="#">Table 2-1</a> through <a href="#">Table 2-3</a> .
<b>Provided with Core</b>	
Documentation	Product Guide
Design Files	Encrypted RTL
Example Design	Not Provided
Test Bench	Verilog <sup>(3)</sup>
Constraints File	XDC
Simulation Models	Encrypted RTL, VHDL or Verilog Structural, C Model <sup>(3)</sup>
Supported Software Drivers <sup>(4)</sup>	Standalone
<b>Tested Design Flows <sup>(5)</sup></b>	
Design Entry Tools	Vivado® Design Suite
Simulation	For supported simulators, see the <a href="#">Xilinx Design Tools: Release Notes Guide</a> .
Synthesis Tools	Vivado Synthesis
<b>Support</b>	
Provided by Xilinx, Inc.	

1. For a complete listing of supported devices, see the Vivado IP Catalog.
2. Video protocol as defined in the *Video IP: AXI Feature Adoption* section of AXI Reference Guide [\[Ref 1\]](#).
3. C Model available on the product page on Xilinx.com at <http://www.xilinx.com/products/ipcenter/EF-DI-GAMMA.htm>
4. Standalone driver details can be found in the SDK directory (<install\_directory>/doc/usenglish/xilinx\_drivers.htm). Linux OS and driver support information is available from the [Xilinx Wiki page](#).
5. For the supported versions of the tools, see the [Xilinx Design Tools: Release Notes Guide](#).

## Overview

Gamma correction, also known as gamma compression or encoding, is used to encode linear luminance or RGB values to match the non-linear characteristics of display devices. Gamma correction helps to map data into a more perceptually uniform domain, so as to optimize perceptual performance of a limited signal range, such as a limited number of bits in each RGB component.

Gamma correction is, in the simplest cases, defined by

$$V_{out} = V_{in}^{\gamma}$$

where the input and output values are between 0 and 1 (Figure 1-1). The case  $\gamma < 1$  is often called gamma compression and  $\gamma > 1$  is called gamma expansion.

When used in conjunction with an embedded or external processor, the Gamma Correction core supports frame-by-frame dynamic reprogramming of the gamma tables. The gamma tables can be reprogrammed with arbitrary functions, supporting a wide range of applications, such as intensity correction, feature enhancement, lin-log, log-lin conversion and thresholding.

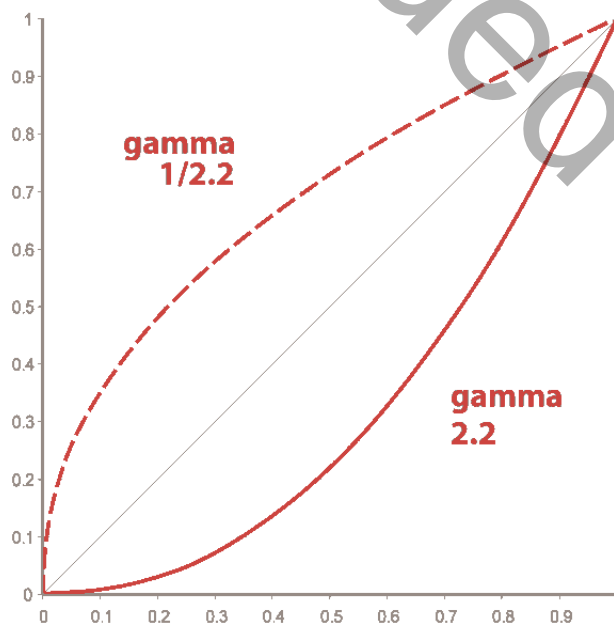

Figure 1-1: Gamma Correction

The Gamma Correction core also offers various configuration options for a designer to optimize the block RAM footprint required by the core.

The Gamma Correction core is implemented as a set of LUTs that are used to perform the data transformation. The width of the input data determines the number of entries in the LUT. For example, 8-bit input data would require  $2^8$  (256) entries in the LUT. The width of the output data determines the width of each entry in the LUT. For example, 12-bit output data would require that each entry in the table be 12-bits wide.

---

## Feature Summary

The Gamma Correction core provides programmable look-up tables for gamma correction. A programmable number of gamma tables allows for separate gamma tables for all color channels, separate tables for luminance and chrominance channels, or one gamma table to be shared by all color channels. Higher resolutions and frame rates can be supported in Xilinx high-performance device families.

---

## Applications

- Pre-processing block for image sensors
- Post-processing block for image data adjustment
- Intensity correction
- Video surveillance
- Consumer displays
- Video conferencing
- Machine vision

---

## Licensing and Ordering Information

This Xilinx LogiCORE IP module is provided under the terms of the [Xilinx Core License Agreement](#). The module is shipped as part of the Vivado Design Suite. For full access to all core functionalities in simulation and in hardware, you must purchase a license for the core. Contact your [local Xilinx sales representative](#) for information about pricing and availability.

For more information, visit the Gamma Correction product web page.

Information about other Xilinx LogiCORE IP modules is available at the [Xilinx Intellectual Property](#) page. For information on pricing and availability of other Xilinx LogiCORE IP modules and tools, contact your [local Xilinx sales representative](#).

Discontinued IP

# Product Specification

---

## Standards

The Gamma Correction core is compliant with the AXI4-Stream Video Protocol and AXI4-Lite interconnect standards. Refer to the *Video IP: AXI Feature Adoption* section of the *Vivado AXI Reference Guide* (UG1037)[[Ref 1](#)] for additional information.

---

## Performance

The following sections detail the performance characteristics of the Gamma Correction core.

### Maximum Frequencies

This section contains typical clock frequencies for the target devices. The maximum achievable clock frequency can vary. The maximum achievable clock frequency and all resource counts can be affected by other tool options, additional logic in the device, using a different version of Xilinx tools and other factors. See [Table 2-1](#) through [Table 2-3](#) for device-specific information.

### Latency

The propagation delay of the Gamma Correction core is always five clock cycles.

### Throughput

The Gamma Correction core outputs one sample per clock cycle.



# Resource Utilization

The information presented in Table 2-1 through Table 2-3 is a guide to the resource utilization and maximum clock frequency of the Gamma Correction core for all input/output width combinations for Virtex®-7, Kintex®-7, Artix®-7 and Zynq®-7000 device families using the Vivado Design Suite. UltraScale™ results are expected to be similar to 7 series results.

This core does not use any dedicated I/O or CLK resources. The design was tested with the AXI4-Lite interface, INTC\_IF and the Debug features disabled.

Table 2-1: Kintex-7 FPGA and Zynq-7000 Devices with Kintex Based Programmable Logic Performance

Input Data Width	Output Data Width	Interpolation	LUT-FF Pairs	LUTs	FFs	Slices	RAM 36/18	DSP48S	Fmax (MHz)
8	8	0	239	195	193	101	0 / 2	0	242
	10	0	250	196	205	99	0 / 2	0	234
	12	0	251	200	217	99	0 / 2	0	234
10	8	0	253	202	211	109	0 / 2	0	242
	10	0	270	209	223	112	0 / 2	0	266
	12	0	272	210	235	111	0 / 2	0	226
12	8	0	261	210	229	109	2 / 0	0	258
	10	0	280	214	241	118	2 / 2	0	258
	12	0	294	219	253	119	2 / 2	0	250
	12	1	378	323	265	156	0 / 3	0	250

Table 2-2: Artix-7 FPGA and Zynq-7000 Device with Artix Based Programmable Logic Performance

Input Data Width	Output Data Width	Interpolation	LUT-FF Pairs	LUTs	FFs	Slices	RAM 36/18	DSP48S	Fmax (MHz)
8	8	0	241	194	193	95	0 / 2	0	188
	10	0	254	195	205	107	0 / 2	0	164
	12	0	255	199	217	106	0 / 2	0	164
10	8	0	254	201	211	105	0 / 2	0	188
	10	0	258	208	223	105	0 / 2	0	164
	12	0	276	209	235	118	0 / 2	0	180
12	8	0	267	215	229	109	2 / 0	0	164
	10	0	277	219	241	113	2 / 2	0	180
	12	0	306	223	253	135	2 / 2	0	180
	12	1	369	323	265	143	0 / 3	0	188

Table 2-3: Virtex-7 FPGA Performance

Input Data Width	Output Data Width	Interpolation	LUT-FF Pairs	LUTs	FFs	Slices	RAM 36/18	DSP48S	Fmax (MHz)
8	8	0	245	195	193	100	0 / 2	0	234
	10	0	250	196	205	100	0 / 2	0	234
	12	0	261	200	217	109	0 / 2	0	234
10	8	0	250	202	211	101	0 / 2	0	242
	10	0	270	209	223	113	0 / 2	0	266
	12	0	280	210	235	113	0 / 2	0	242
12	8	0	272	210	229	121	2 / 0	0	258
	10	0	274	214	241	112	2 / 2	0	258
	12	0	284	219	253	113	2 / 2	0	258
	12	1	366	323	265	152	0 / 3	0	266

**Note:** Performance numbers for Kintex-7 and Artix-7 FPGAs also apply to Zynq-7000 devices that have the same fabric.

## Core Interfaces and Register Space

### Port Descriptions

The Gamma Correction core uses industry standard control and data interfaces to connect to other system components. The following sections describe the various interfaces available with the core. [Figure 2-1](#) illustrates an I/O diagram of the Gamma Correction core. Some signals are optional and not present for all configurations of the core. The AXI4-Lite interface and the `IRQ` pin are present only when the core is configured via the GUI with an AXI4-Lite control interface. The `INTC_IF` interface is present only when the core is configured via the GUI with the INTC interface enabled.

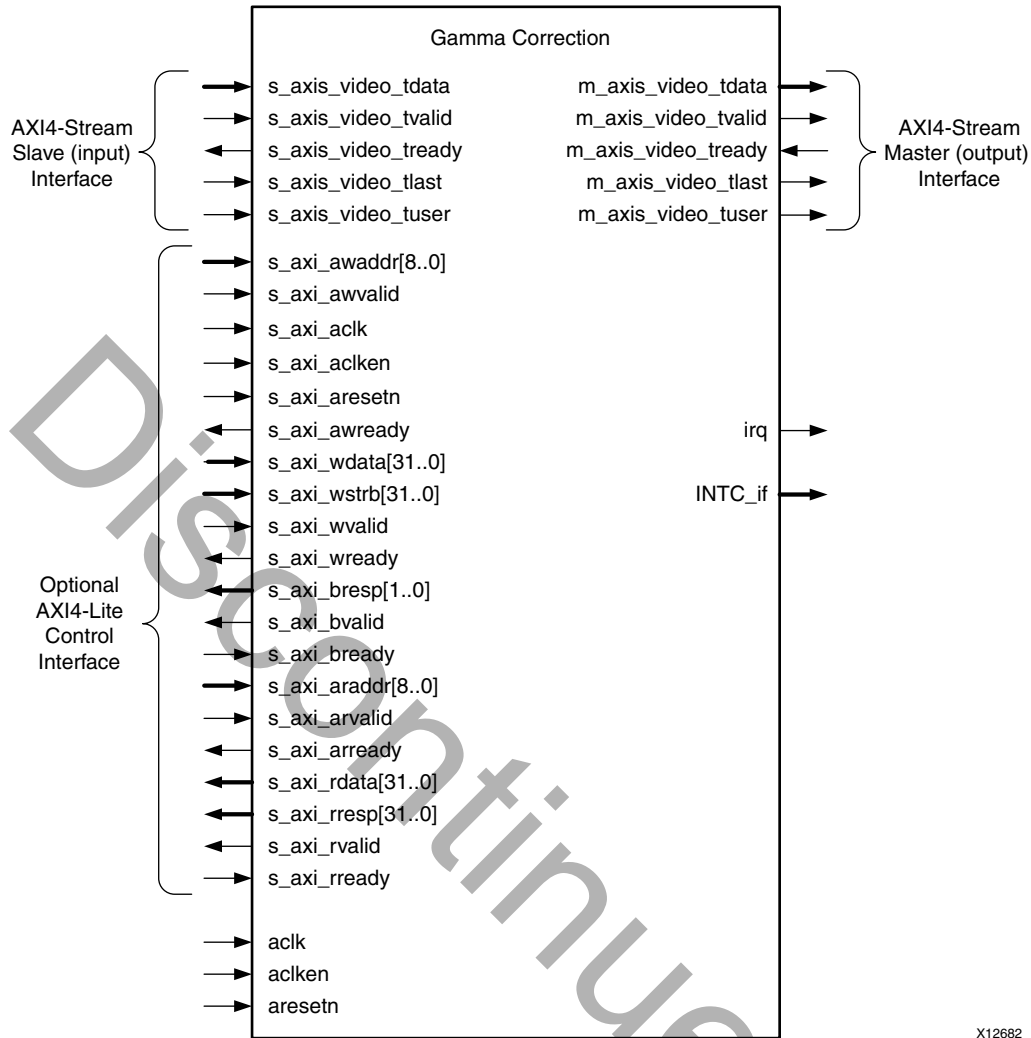

X12682

Figure 2-1: Gamma Correction Core Top-Level Signaling Interface

## Common Interface Signals

Table 2-4 summarizes the signals which are either shared by, or not part of the dedicated AXI4-Stream data or AXI4-Lite control interfaces.

Table 2-4: Common Interface Signals

Signal Name	Direction	Width	Description
ACLK	In	1	Video Core Clock
ACLKEN	In	1	Video Core Active High Clock Enable
ARESETn	In	1	Video Core Active Low Synchronous Reset
INTC_IF	Out	9	Optional External Interrupt Controller Interface. Available only when INTC_IF is selected on GUI.
IRQ	Out	1	Optional Interrupt Request Pin. Available only when AXI4-Lite interface is selected on GUI.

The `ACLK`, `ACLKEN` and `ARESETn` signals are shared between the core and the AXI4-Stream data interfaces. The AXI4-Lite control interface has its own set of clock, clock enable and reset pins: `S_AXI_ACLK`, `S_AXI_ACLKEN` and `S_AXI_ARESETn`. Refer to [The Interrupt Subsystem](#) for a description of the `INTC_IF` and `IRQ` pins.

## ACLK

The AXI4-Stream interface must be synchronous to the core clock signal `ACLK`. All AXI4-Stream interface input signals are sampled on the rising edge of `ACLK`. All AXI4-Stream output signal changes occur after the rising edge of `ACLK`. The AXI4-Lite interface is unaffected by the `ACLK` signal.

## ACLKEN

The `ACLKEN` pin is an active-high, synchronous clock-enable input pertaining to AXI4-Stream interfaces. Setting `ACLKEN` low (de-asserted) halts the operation of the core despite rising edges on the `ACLK` pin. Internal states are maintained, and output signal levels are held until `ACLKEN` is asserted again. When `ACLKEN` is de-asserted, core inputs are not sampled, except `ARESETn`, which supersedes `ACLKEN`. The AXI4-Lite interface is unaffected by the `ACLKEN` signal.

## ARESETn

The `ARESETn` pin is an active-low, synchronous reset input pertaining to only AXI4-Stream interfaces. `ARESETn` supersedes `ACLKEN`, and when set to 0, the core resets at the next rising edge of `ACLK` even if `ACLKEN` is de-asserted. The `ARESETn` signal must be synchronous to the `ACLK` and must be held low for a minimum of 32 clock cycles of the slowest clock. The AXI4-Lite interface is unaffected by the `ARESETn` signal.

## Data Interface

The Gamma Correction core receives and transmits data using AXI4-Stream interfaces that implement a video protocol as defined in the *Video IP: AXI Feature Adoption* section of the *AXI Reference Guide* (UG761) [Ref 1].

## AXI4-Stream Signal Names and Descriptions

Table 2-5 describes the AXI4-Stream signal names and descriptions.

Table 2-5: AXI4-Stream Data Interface Signal Descriptions

Signal Name	Direction	Width	Description
<code>s_axis_video_tdata</code>	In	8,16,24,32,40	Input Video Data
<code>s_axis_video_tvalid</code>	In	1	Input Video Valid Signal
<code>s_axis_video_tready</code>	Out	1	Input Ready

Table 2-5: AXI4-Stream Data Interface Signal Descriptions (Cont'd)

Signal Name	Direction	Width	Description
s_axis_video_tuser	In	1	Input Video Start Of Frame
s_axis_video_tlast	In	1	Input Video End Of Line
m_axis_video_tdata	Out	8,16,24,32,40	Output Video Data
m_axis_video_tvalid	Out	1	Output Valid
m_axis_video_tready	In	1	Output Ready
m_axis_video_tuser	Out	1	Output Video Start Of Frame
m_axis_video_tlast	Out	1	Output Video End Of Line

### Video Data

The AXI4-Stream interface specification restricts TDATA widths to integer multiples of 8 bits. Therefore, 10 and 12 bit data must be padded with zeros on the MSB to form N\*8-bit wide vector before connecting to s\_axis\_video\_tdata. Padding does not affect the size of the core.

Similarly, RGB data on the Gamma Correction core output m\_axis\_video\_tdata is packed and padded to multiples of 8 bits as necessary, as seen in Figure 2-2. Zero padding the most significant bits is only necessary for 10 and 12 bit wide data.

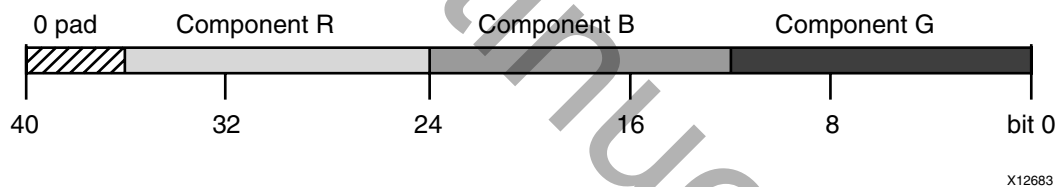

Figure 2-2: RGB Data Encoding on m\_axis\_video\_tdata

### READY/VALID Handshake

A valid transfer occurs whenever READY, VALID, ACLKEN, and ARESETn are high at the rising edge of ACLK, as seen in Figure 2-3. During valid transfers, DATA only carries active video data. Blank periods and ancillary data packets are not transferred via the AXI4-Stream video protocol.

### Guidelines on Driving s\_axis\_video\_tvalid

Once s\_axis\_video\_tvalid is asserted, no interface signals (except the Gamma Correction core driving s\_axis\_video\_tready) may change value until the transaction completes (s\_axis\_video\_tready, s\_axis\_video\_tvalid ACLKEN high on the rising edge of ACLK). Once asserted, s\_axis\_video\_tvalid may only be de-asserted after a transaction has completed. Transactions may not be retracted or aborted. In any cycle following a transaction, s\_axis\_video\_tvalid can either be de-asserted or remain asserted to initiate a new transfer.

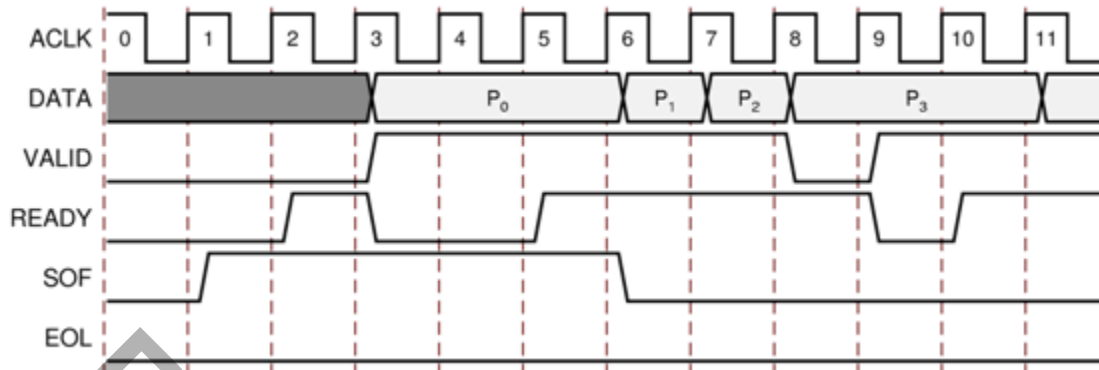

Figure 2-3: Example of READY/VALID Handshake, Start of a New Frame

### Guidelines on Driving m\_axis\_video\_tready

The `m_axis_video_tready` signal may be asserted before, during or after the cycle in which the Gamma Correction core asserted `m_axis_video_tvalid`. The assertion of `m_axis_video_tready` may be dependent on the value of `m_axis_video_tvalid`. A slave that can immediately accept data qualified by `m_axis_video_tvalid`, should pre-assert its `m_axis_video_tready` signal until data is received. Alternatively, `m_axis_video_tready` can be registered and driven the cycle following `VALID` assertion.



**RECOMMENDED:** To minimize latency, the AXI4-Stream slave should drive `READY` independently, or pre-assert `READY`.

### Start of Frame Signals - m\_axis\_video\_tuser0, s\_axis\_video\_tuser0

The Start-Of-Frame (`SOF`) signal, physically transmitted over the AXI4-Stream `TUSER0` signal, marks the first pixel of a video frame. The `SOF` pulse is 1 valid transaction wide, and must coincide with the first pixel of the frame, as seen in Figure 2-3. `SOF` serves as a frame synchronization signal, which allows downstream cores to re-initialize, and detect the first pixel of a frame. The `SOF` signal may be asserted an arbitrary number of `ACLK` cycles before the first pixel value is presented on `DATA`, as long as a `VALID` is not asserted.

### End of Line Signals - m\_axis\_video\_tlast, s\_axis\_video\_tlast

The End-Of-Line signal, physically transmitted over the AXI4-Stream `TLAST` signal, marks the last pixel of a line. The `EOL` pulse is 1 valid transaction wide, and must coincide with the last pixel of a scan-line, as seen in Figure 2-4.

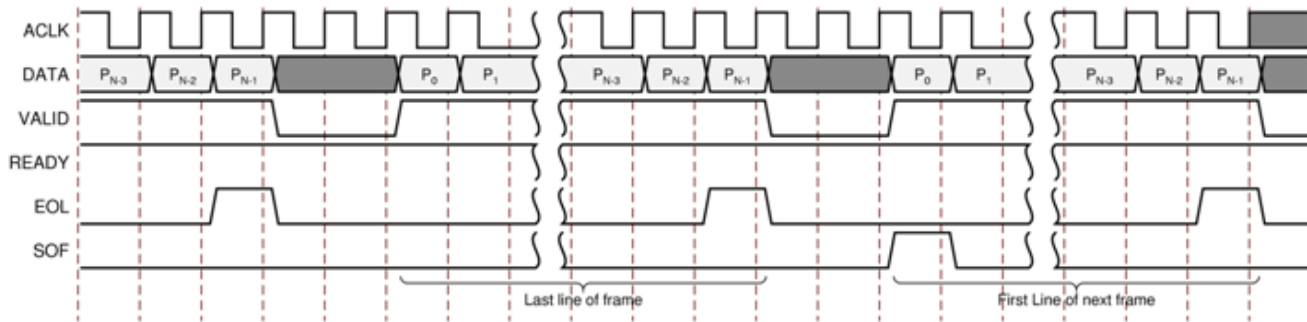

Figure 2-4: Use of EOL and SOF Signals

## Control Interface

When configuring the core, you can add an AXI4-Lite register interface to dynamically control the behavior of the core. The AXI4-Lite slave interface facilitates integrating the core into a processor system, or along with other video or AXI4-Lite compliant IP, connected via AXI4-Lite interface to an AXI4-Lite master. In a static configuration with a fixed set of parameters (constant configuration), the core is instantiated without the AXI4-Lite control interface, which reduces the core slice footprint.

## Constant Configuration

The constant configuration caters to designs that use the core in one setup that will not need to change over time. In constant configuration the image resolution (number of active pixels per scan line and the number of active scan lines per frame) and the Gamma Correction LUTs are hard coded into the core through the Vivado IP catalog. Since there is no AXI4-Lite interface, the core is not programmable, but can be reset, enabled, or disabled using the `ARESETn` and `ACLKEN` ports.

## AXI4-Lite Interface

The AXI4-Lite interface allows you to dynamically control parameters within the core. Core configuration can be accomplished using an AXI4-Stream master state machine, or an embedded ARM or soft system processor such as MicroBlaze.

The Gamma Correction core can be controlled via the AXI4-Lite interface using read and write transactions to the gamma register space.

Table 2-6: AXI4-Lite Interface Signals

Signal Name	Direction	Width	Description
s_axi_aclk	In	1	AXI4-Lite clock
s_axi_aclken	In	1	AXI4-Lite clock enable
s_axi_aresetn	In	1	AXI4-Lite synchronous Active Low reset
s_axi_awvalid	In	1	AXI4-Lite Write Address Channel Write Address Valid.

Table 2-6: AXI4-Lite Interface Signals (Cont'd)

Signal Name	Direction	Width	Description
s_axi_awread	Out	1	AXI4-Lite Write Address Channel Write Address Ready. Indicates DMA ready to accept the write address.
s_axi_awaddr	In	32	AXI4-Lite Write Address Bus
s_axi_wvalid	In	1	AXI4-Lite Write Data Channel Write Data Valid.
s_axi_wready	Out	1	AXI4-Lite Write Data Channel Write Data Ready. Indicates DMA is ready to accept the write data.
s_axi_wdata	In	32	AXI4-Lite Write Data Bus
s_axi_bresp	Out	2	AXI4-Lite Write Response Channel. Indicates results of the write transfer.
s_axi_bvalid	Out	1	AXI4-Lite Write Response Channel Response Valid. Indicates response is valid.
s_axi_bready	In	1	AXI4-Lite Write Response Channel Ready. Indicates target is ready to receive response.
s_axi_arvalid	In	1	AXI4-Lite Read Address Channel Read Address Valid
s_axi_arready	Out	1	Ready. Indicates DMA is ready to accept the read address.
s_axi_araddr	In	32	AXI4-Lite Read Address Bus
s_axi_rvalid	Out	1	AXI4-Lite Read Data Channel Read Data Valid
s_axi_rready	In	1	AXI4-Lite Read Data Channel Read Data Ready. Indicates target is ready to accept the read data.
s_axi_rdata	Out	32	AXI4-Lite Read Data Bus
s_axi_rresp	Out	2	AXI4-Lite Read Response Channel Response. Indicates results of the read transfer.

## S\_AXI\_ACLK

The AXI4-Lite interface must be synchronous to the S\_AXI\_ACLK clock signal. The AXI4-Lite interface input signals are sampled on the rising edge of ACLK. The AXI4-Lite output signal changes occur after the rising edge of ACLK. The AXI4-Stream interfaces signals are not affected by the S\_AXI\_ACLK.

## S\_AXI\_ACLKEN

The S\_AXI\_ACLKEN pin is an active-high, synchronous clock-enable input for the AXI4-Lite interface. Setting S\_AXI\_ACLKEN low (de-asserted) halts the operation of the AXI4-Lite interface despite rising edges on the S\_AXI\_ACLK pin. AXI4-Lite interface states are maintained, and AXI4-Lite interface output signal levels are held until S\_AXI\_ACLKEN is asserted again. When S\_AXI\_ACLKEN is de-asserted, AXI4-Lite interface inputs are not sampled, except S\_AXI\_ARESETn, which supersedes S\_AXI\_ACLKEN. The AXI4-Stream interfaces signals are not affected by the S\_AXI\_ACLKEN.



## S\_AXI\_ARESETn

The S\_AXI\_ARESETn pin is an active-low, synchronous reset input for the AXI4-Lite interface. S\_AXI\_ARESETn supersedes S\_AXI\_ACLKEN, and when set to 0, the core resets at the next rising edge of S\_AXI\_ACLK even if S\_AXI\_ACLKEN is de-asserted. The S\_AXI\_ARESETn signal must be synchronous to the S\_AXI\_ACLK and must be held low for a minimum of 32 clock cycles of the slowest clock. The S\_AXI\_ARESETn input is resynchronized to the ACLK clock domain. The AXI4-Stream interfaces and core signals are also reset by S\_AXI\_ARESETn.

## Register Space

The standardized Xilinx Video IP register space is partitioned to control-, timing-, and core specific registers. The Gamma Correction core uses only one timing related register, ACTIVE\_SIZE (0x0020), which allows specifying the input frame dimensions. The core has two core specific registers, the Gamma\_Addr\_Data (0x0104) which is used to reprogram the Gamma LUTs and the Gamma\_Table\_Update (0x0100) which is used to tell the Gamma Correction core when to move to a new LUT.

Table 2-7: Register Names and Descriptions

Address (hex) BASEADDR +	Register Name	Access Type	Double Buffered	Default Value	Register Description
0x0000	CONTROL	R/W	N	Power-on-Reset : 0x0	Bit 0: SW_ENABLE Bit 1: REG_UPDATE Bit 4: BYPASS <sup>(1)</sup> Bit 5: TEST_PATTERN <sup>(1)</sup> Bit 30: FRAME_SYNC_RESET (1: reset) Bit 31: SW_RESET (1: reset)
0x0004	STATUS	R/W	No	0	Bit 0: PROC_STARTED Bit 1: EOF Bit 16: SLAVE_ERROR
0x0008	ERROR	R/W	No	0	Bit 0: SLAVE_EOL_EARLY Bit 1: SLAVE_EOL_LATE Bit 2: SLAVE_SOF_EARLY Bit 3: SLAVE_SOF_LATE
0x000C	IRQ_ENABLE	R/W	No	0	16-0: Interrupt enable bits corresponding to STATUS bits
0x0010	VERSION	R	N/A	0x07000000	7-0: REVISION_NUMBER 11-8: PATCH_ID 15-12: VERSION_REVISION 23-16: VERSION_MINOR 31-24: VERSION_MAJOR
0x0014	SYSDEBUG0	R	N/A	0	0-31: Frame Throughput monitor <sup>(1)</sup>

Table 2-7: Register Names and Descriptions (Cont'd)

Address (hex) BASEADDR +	Register Name	Access Type	Double Buffered	Default Value	Register Description
0x0018	SYSDEBUG1	R	N/A	0	0-31: Line Throughput monitor <sup>(1)</sup>
0x001C	SYSDEBUG2	R	N/A	0	0-31: Pixel Throughput monitor <sup>(1)</sup>
0x0020	ACTIVE_SIZE	R/W	Yes	Specified via GUI	12-0: Number of Active Pixels per Scanline 28-16: Number of Active Lines per Frame
0x0100	Gamma_Table_Update	R/W	Yes	0	Denotes when the core should swap to the inactive LUT.
0x0104	Gamma_Addr_Data	R/W	No	0	[31-16]: Target address in gamma LUT [15-0]: Value to write to gamma LUT

1. Only available when the debugging features option is enabled in the GUI at the time the core is instantiated.

### CONTROL (0x0000) Register

Bit 0 of the CONTROL register, SW\_ENABLE, facilitates enabling and disabling the core from software. Writing '0' to this bit effectively disables the core halting further operations, which blocks the propagation of all video signals. After Power up, or Global Reset, the SW\_ENABLE defaults to 0 for the AXI4-Lite interface. Similar to the ACLKEN pin, the SW\_ENABLE flag is not synchronized with the AXI4-Stream interfaces. Enabling or disabling the core takes effect immediately, irrespective of the core processing status. Disabling the core for extended periods may lead to image tearing.

Bit 1 of the CONTROL register, REG\_UPDATE is a write done semaphore for the host processor, which facilitates committing all user and timing register updates simultaneously. The Gamma Correction core ACTIVE\_SIZE and BAYER\_PHASE registers are double buffered. One set of registers (the processor registers) is directly accessed by the processor interface, while the other set (the active set) is actively used by the core. New values written to the processor registers will get copied over to the active set at the end of the AXI4-Stream frame, if and only if REG\_UPDATE is set. Setting REG\_UPDATE to 0 before updating multiple register values, then setting REG\_UPDATE to 1 when updates are completed ensures all registers are updated simultaneously at the frame boundary without causing image tearing.

Bit 4 of the CONTROL register, BYPASS, switches the core to bypass mode if debug features are enabled. In bypass mode the Gamma Correction core processing function is bypassed, and the core repeats AXI4-Stream input samples on its output. Refer to [Debug Tools in Appendix C](#) for more information. If debug features were not included at instantiation, this flag has no effect on the operation of the core. Switching bypass mode on or off is not synchronized to frame processing, therefore can lead to image tearing.

Bit 5 of the `CONTROL` register, `TEST_PATTERN`, switches the core to test-pattern generator mode if debug features are enabled. Refer to [Debug Tools in Appendix C](#) for more information. If debug features were not included at instantiation, this flag has no effect on the operation of the core. Switching test-pattern generator mode on or off is not synchronized to frame processing, therefore can lead to image tearing.

Bits 30 and 31 of the `CONTROL` register, `FRAME_SYNC_RESET` and `SW_RESET` facilitate software reset. Setting `SW_RESET` reinitializes the core to GUI default values, all internal registers and outputs are cleared and held at initial values until `SW_RESET` is set to 0. The `SW_RESET` flag is not synchronized with the AXI4-Stream interfaces. Resetting the core while frame processing is in progress will cause image tearing. For applications where the soft-ware reset functionality is desirable, but image tearing has to be avoided a frame synchronized software reset (`FRAME_SYNC_RESET`) is available. Setting `FRAME_SYNC_RESET` to 1 will reset the core at the end of the frame being processed, or immediately if the core is between frames when the `FRAME_SYNC_RESET` was asserted. After reset, the `FRAME_SYNC_RESET` bit is automatically cleared, so the core can get ready to process the next frame of video as soon as possible. The default value of both `RESET` bits is 0. Core instances with no AXI4-Lite control interface can only be reset via the `ARESETn` pin.

### STATUS (0x0004) Register

All bits of the `STATUS` register can be used to request an interrupt from the host processor. To facilitate identification of the interrupt source, bits of the `STATUS` register remain set after an event associated with the particular `STATUS` register bit, even if the event condition is not present at the time the interrupt is serviced.

Bits of the `STATUS` register can be cleared individually by writing '1' to the bit position.

Bit 0 of the `STATUS` register, `PROC_STARTED`, indicates that processing of a frame has commenced via the AXI4-Stream interface.

Bit 1 of the `STATUS` register, End-of-frame (EOF), indicates that the processing of a frame has completed.

Bit 16 of the `STATUS` register, `SLAVE_ERROR`, indicates that one of the conditions monitored by the `ERROR` register has occurred.

### ERROR (0x0008) Register

Bit 16 of the `STATUS` register, `SLAVE_ERROR`, indicates that one of the conditions monitored by the `ERROR` register has occurred. This bit can be used to request an interrupt from the host processor. To facilitate identification of the interrupt source, bits of the `STATUS` and `ERROR` registers remain set after an event associated with the particular `ERROR` register bit, even if the event condition is not present at the time the interrupt is serviced.

Bits of the `ERROR` register can be cleared individually by writing '1' to the bit position to be cleared.

Bit 0 of the `ERROR` register, `EOL_EARLY`, indicates an error during processing a video frame via the AXI4-Stream slave port. The number of pixels received between the latest and the preceding `EOL` signal was less than the value programmed into the `ACTIVE_SIZE` register.

Bit 1 of the `ERROR` register, `EOL_LATE`, indicates an error during processing a video frame via the AXI4-Stream slave port. The number of pixels received between the last `EOL` signal surpassed the value programmed into the `ACTIVE_SIZE` register.

Bit 2 of the `ERROR` register, `SOF_EARLY`, indicates an error during processing a video frame via the AXI4-Stream slave port. The number of pixels received between the latest and the preceding Start-Of-Frame (`SOF`) signal was less than the value programmed into the `ACTIVE_SIZE` register.

Bit 3 of the `ERROR` register, `SOF_LATE`, indicates an error during processing a video frame via the AXI4-Stream slave port. The number of pixels received between the last `SOF` signal surpassed the value programmed into the `ACTIVE_SIZE` register.

### **IRQ\_ENABLE (0x000C) Register**

Any bits of the `STATUS` register can generate a host-processor interrupt request via the `IRQ` pin. The Interrupt Enable register facilitates selecting which bits of `STATUS` register will assert `IRQ`. Bits of the `STATUS` registers are masked by (AND) corresponding bits of the `IRQ_ENABLE` register and the resulting terms are combined (OR) together to generate `IRQ`.

### **Version (0x0010) Register**

Bit fields of the Version Register facilitate software identification of the exact version of the hardware peripheral incorporated into a system. The core driver can take advantage of this Read-Only value to verify that the software is matched to the correct version of the hardware. See [Table 2-7](#) for details.

### **SYSDEBUG0 (0x0014) Register**

The `SYSDEBUG0`, or Frame Throughput Monitor, register indicates the number of frames processed since power-up or the last time the core was reset. The `SYSDEBUG` registers can be useful to identify external memory / Frame buffer / or throughput bottlenecks in a video system. Refer to [Debug Tools in Appendix C](#) for more information.

### **SYSDEBUG1 (0x0018) Register**

The `SYSDEBUG1`, or Line Throughput Monitor, register indicates the number of lines processed since power-up or the last time the core was reset. The `SYSDEBUG` registers can be useful to identify external memory / Frame buffer / or throughput bottlenecks in a video system. Refer to [Debug Tools in Appendix C](#) for more information.

## SYSDEBUG2 (0x001C) Register

The `SYSDEBUG2`, or Pixel Throughput Monitor, register indicates the number of pixels processed since power-up or the last time the core was reset. The `SYSDEBUG` registers can be useful to identify external memory / Frame buffer / or throughput bottlenecks in a video system. Refer to [Debug Tools in Appendix C](#) for more information.

## ACTIVE\_SIZE (0x0020) Register

The `ACTIVE_SIZE` register encodes the number of active pixels per scan line and the number of active scan lines per frame. The lower half-word (bits 12:0) encodes the number of active pixels per scan line. Supported values are between 32 and the value provided in the **Maximum number of pixels per scan line** field. The upper half-word (bits 28:16) encodes the number of active lines per frame. Supported values are 32 to 7680. To avoid processing errors, restrict values written to `ACTIVE_SIZE` to the range supported by the core instance.

## Gamma\_Table\_Update (0x0100)

The `Gamma_Table_Update` register is used when the Gamma Correction core is configured to use Double Buffered LUTs. When configured to use double buffered LUTs, the Gamma Correction core uses two banks of memory for LUT. One bank is active and process valid data. The other bank is inactive and can be programmed with new values using the AX4-Lite interface. Once the inactive bank has been fully programmed, the Gamma Correction core can be signaled to swap banks by setting bit 0 of the `Gamma_Table_Update` register to 1.

## Gamma\_Addr\_Data (0x0104)

The Gamma LUTs can be reprogrammed dynamically through the AXI4-Lite interface. A new value is written to the LUT by writing the address of the LUT location and the new data value to the `Gamma_Addr_Data` register.

## Updating the Gamma Tables Using the AXI4-Lite Interface

The double- and single-buffered interfaces require that each write operation contain a valid address and data. Bits [31-16] of the `Gamma_Addr_Data` register are designated as the look-up table address, while bits [15-0] represent the value of word to be written into the gamma look-up table(s). The valid address range for the data depends on the input width, number of shared LUTs, and whether interpolation is used, as shown in [Table 2-8](#) and [Table 2-9](#).

Table 2-8: Valid Address Ranges for LUTs for RGB Data

Input Width	LUTs <sup>(1)</sup>	Interpolation	Red Baseaddr, Range	Green Baseaddr, Range	Blue Baseaddr, Range
8	3	0	0x0000, 0x00FF	0x0100, 0x01FF	0x0200, 0x02FF
8	1	0	0x0000, 0x00FF	N/A	N/A
10	3	0	0x0000, 0x03FF	0x0400, 0x07FF	0x0800, 0x0BFF
10	1	0	0x0000, 0x03FF	N/A	N/A
12	3	0	0x0000, 0x0FFF	0x1000, 0x1FFF	0x2000, 0x2FFF
12	1	0	0x0000, 0x0FFF	N/A	N/A
12	3	1	0x0000, 0x03FF	0x0400	0x0800, 0x0BFF
12	1	1	0x0000, 0x03FF	N/A	N/A

- The number of lookup tables used is as follows:  
 3: when Independent look-up tables for each Color Channel is selected  
 1: when Identical look-up tables for all Color Channels is selected

Table 2-9: Valid Address Ranges for LUTs for YCrCb 4:4:4/4:2:2/4:2:0 or Mono Data

Input Width	LUTs <sup>(1)</sup>	Interpolation	Y/Mono Baseaddr, Range	Cb or (Cb/Cr) Baseaddr, Range	Cr Baseaddr, Range
8	3	0	0x0000, 0x00FF	0x0100, 0x01FF	0x0200, 0x02FF
8	2	0	0x0000, 0x00FF	0x0100, 0x01FF	N/A
8	1	0	0x0000, 0x00FF	N/A	N/A
10	3	0	0x0000, 0x03FF	0x0400, 0x07FF	0x0800, 0x0BFF
10	2	0	0x0000, 0x03FF	0x0400, 0x07FF	N/A
10	1	0	0x0000, 0x03FF	N/A	N/A
12	3	0	0x0000, 0x0FFF	0x1000, 0x1FFF	0x2000, 0x2FFF
12	2	0	0x0000, 0x0FFF	0x1000, 0x1FFF	N/A
12	1	0	0x0000, 0x0FFF	N/A	N/A
12	3	1	0x0000, 0x03FF	0x0400	0x0800, 0x0BFF
12	2	1	0x0000, 0x03FF	0x0400	N/A
12	1	1	0x0000, 0x03FF	N/A	N/A

- The number of LUTs used is as follows:  
 3: when Independent LUTs for each Color Channel is selected  
 2: when Identical look-up tables for Chrominance Channels Only is selected  
 1: when Identical look-up tables for all Color Channels is selected

## The Interrupt Subsystem

STATUS register bits can trigger interrupts so embedded application developers can quickly identify faulty interfaces or incorrectly parameterized cores in a video system. Irrespective of whether the AXI4-Lite control interface is present or not, the Gamma

Correction core detects AXI4-Stream framing errors, as well as the beginning and the end of frame processing.

When the core is instantiated with an AXI4-Lite Control interface, the optional interrupt request pin (`IRQ`) is present. Events associated with bits of the `STATUS` register can generate a (level triggered) interrupt, if the corresponding bits of the interrupt enable register (`IRQ_ENABLE`) are set. Once set by the corresponding event, bits of the `STATUS` register stay set until the user application clears them by writing '1' to the desired bit positions. Using this mechanism the system processor can identify and clear the interrupt source.

Without the AXI4-Lite interface the user can still benefit from the core signaling error and status events. By selecting the **Enable INTC Port** option, the core generates the optional `INTC_IF` port. This vector of signals gives parallel access to the individual interrupt sources, as described in [Table 2-10](#).

Unlike `STATUS` and `ERROR` flags, `INTC_IF` signals are not held, rather stay asserted only while the corresponding event persists.

Table 2-10: `INTC_IF` Signal Functions

<code>INTC_IF</code> signal	Function
0	Frame processing start
1	Frame processing complete
2	Reserved
3	Reserved
4	Slave_Error
5	EOL Early
6	EOL Late
7	SOF Early
8	SOF Late

In a system integration tool, the interrupt controller `INTC` IP can be used to register the selected `INTC_IF` signals as edge triggered interrupt sources. The `INTC` IP provides functionality to mask (enable or disable), as well as identify individual interrupt sources from software. Alternatively, for an external processor, you can custom build a priority interrupt controller to aggregate interrupt requests and identify interrupt sources.

# Designing with the Core

---

## General Design Guidelines

The Gamma Correction core uses a LUT programmed with a Gamma Correction Curve or user-defined function to convert input data to output data. The core processes samples provided via an AXI4-Stream slave interface, outputs pixels via an AXI4-Stream master interface, and can be controlled via an optional AXI4-Lite interface. The Gamma block cannot change the input/output image sizes, the input and output pixel clock rates, or the frame rate. It is recommended that the Gamma Correction core is used in conjunction with the Xilinx LogiCORE IP Video In to AXI4-Stream and Video Timing Controller cores. The Video Timing Controller core measures the timing parameters, such as number of active scan lines, number of active pixels per scan line of the image sensor. The Video In to AXI4-Stream core converts a clocked parallel video interface with sync and or blank signals to AXI4-Stream.

Typically, the Image Enhancement core is part of an Image Sensor Pipeline (ISP) System, as shown in [Figure 3-1](#).



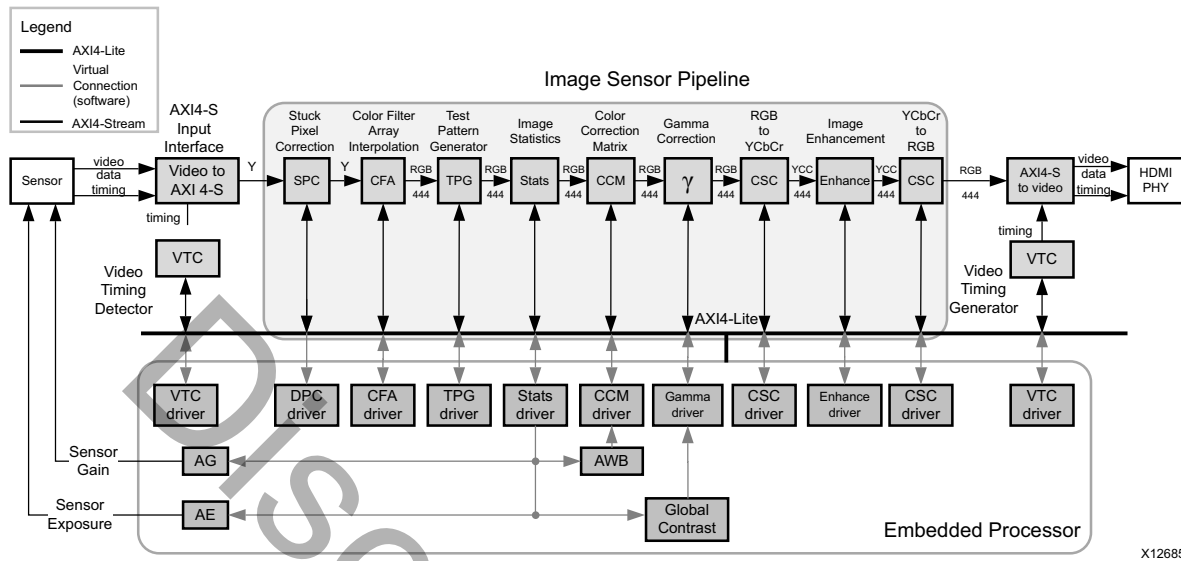

Figure 3-1: Image Sensor Pipeline System with Image Enhancement Core

The Gamma Correction core allows you to select an input data width that is different than the output data width. The core is implemented as a set of LUTs that are used to perform the data transformation. The width of the input data determines the number of entries in the LUT. For example, 8-bit input data would require  $2^8$  (256) entries in the LUT. The width of the output data determines the width of each entry in the LUT. For example, 12-bit output data would require that each entry in the table be 12-bits wide. When the **Calculate Gamma Value** option is used when generating the core, the tables are properly sized and scaled to match the selected input and output data widths. When the **Load Initialization File** option is used, the tables are properly sized to match the input data width, but the user is responsible for properly scaling the data. The user is also responsible for properly scaling the data when new values are loaded into the core using the AXI4-Lite processor interface.

## Clock, Enable, and Reset Considerations

### ACLK

The master and slave AXI4-Stream video interfaces use the ACLK clock signal as their shared clock reference, as shown in Figure 3-2.

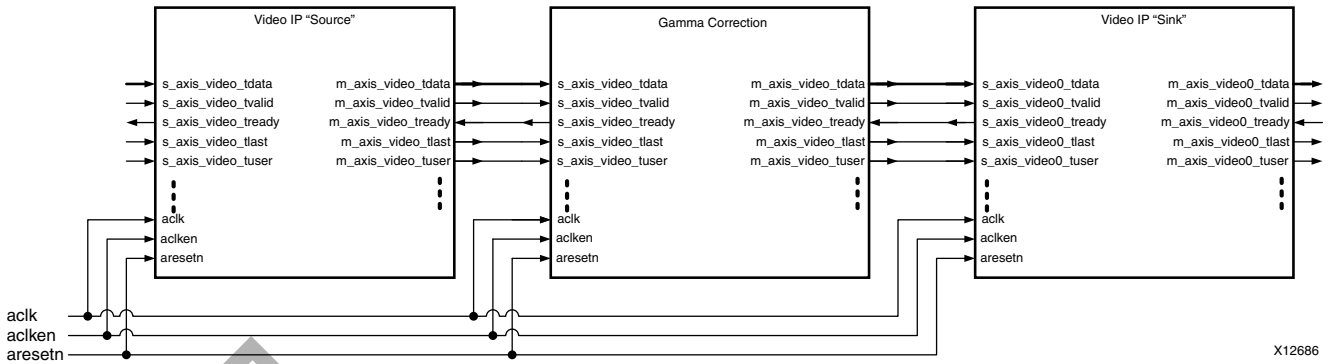

Figure 3-2: Example of ACLK Routing in an ISP Processing Pipeline

## S\_AXI\_ACLK

The AXI4-Lite interface uses the S\_AXI\_ACLK pin as its clock source. The ACLK pin is not shared between the AXI4-Lite and AXI4-Stream interfaces. The Image Enhancement core contains clock-domain crossing logic between the ACLK (AXI4-Stream and Video Processing) and S\_AXI\_ACLK (AXI4-Lite) clock domains. The core automatically ensures that the AXI4-Lite transactions completes even if the video processing is stalled with ARESETn, ACLKEN or with the video clock not running.

## ACLKEN

The Image Enhancement core has two enable options: the ACLKEN pin (hardware clock enable), and the software reset option provided through the AXI4-Lite control interface (when present).

ACLKEN may not be synchronized internally to AXI4-Stream frame processing therefore de-asserting ACLKEN for extended periods of time may lead to image tearing.

The ACLKEN pin facilitates:

- Multi-cycle path designs (high speed clock division without clock gating)
- Standby operation of subsystems to save on power
- Hardware controlled bring-up of system components



**IMPORTANT:** When ACLKEN (clock enable) pins are used (toggled) in conjunction with a common clock source driving the master and slave sides of an AXI4-Stream interface, to prevent transaction errors the ACLKEN pins associated with the master and slave component interfaces must also be driven by the same signal (Figure 2-2).



**IMPORTANT:** When two cores connected through AXI4-Stream interfaces, where only the master or the slave interface has an ACLKEN port, which is not permanently tied high, the two interfaces should be

connected through the AXI4-Stream Interconnect or AXI-FIFO cores to avoid data corruption (Figure 2-3).

---

## S\_AXI\_ACLKEN

The S\_AXI\_ACLKEN is the clock enable signal for the AXI4-Lite interface only. Driving this signal Low only affects the AXI4-Lite interface and does not halt the video processing in the ACLK clock domain.

## ARESETn

The Image Enhancement core has two reset source: the ARESETn pin (hardware reset), and the software reset option provided through the AXI4-Lite control interface (when present).



**IMPORTANT:** ARESETn is not synchronized internally to AXI4-Stream frame processing. Deasserting ARESETn while a frame is being process leads to image tearing.

---

The external reset pulse needs to be held for 32 ACLK cycles to reset the core. The ARESETn signal only resets the AXI4-Stream interfaces. The AXI4-Lite interface is unaffected by the ARESETn signal to allow the video processing core to be reset without halting the AXI4-Lite interface.



**IMPORTANT:** When a system with multiple-clocks and corresponding reset signals are being reset, the reset generator has to ensure all signals are asserted/de-asserted long enough so that all interfaces and clock-domains are correctly reinitialized.

---

## S\_AXI\_ARESETn

The S\_AXI\_ARESETn signal is synchronous to the S\_AXI\_ACLK clock domain, but is internally synchronized to the ACLK clock domain. The S\_AXI\_ARESETn signal resets the entire core including the AXI4-Lite and AXI4-Stream interfaces.

---

# System Considerations

The Gamma Correction core needs to be configured for the actual image sensor frame-size to operate properly. To gather the frame size information from the input video, it can be connected to the Video In to AXI4-Stream input and the Video Timing Controller cores. The timing detector logic in the Video Timing Controller will gather the video timing signals. The AXI4-Lite control interface on the Video Timing Controller allows the system processor to read out the measured frame dimensions, and program all downstream cores, such as the Gamma, with the appropriate image dimensions.

If the target system uses only one configuration of the Gamma registers, (for example, does not ever need to be programmed), you may choose to create a constant configuration by removing the AXI4-Lite interface. This reduces the core slice footprint.

## Clock Domain Interaction

The `ARESETn` and `ACLKEN` input signals will not reset or halt the AXI4-Lite interface. This allows the video processing to be reset or halted separately from the AXI4-Lite interface without disrupting AXI4-Lite transactions.

The AXI4-Lite interface will respond with an error if the core registers cannot be read or written within 128 `S_AXI_ACLK` clock cycles. The core registers cannot be read or written if the `ARESETn` signal is held low, if the `ACLKEN` signal is held low or if the `ACLK` signal is not connected or not running. If core register read does not complete, the AXI4-Lite read transaction will respond with **10** on the `S_AXI_RRESP` bus. Similarly, if a core register write does not complete, the AXI4-Lite write transaction will respond with **10** on the `S_AXI_BRESP` bus. The `S_AXI_ARESETn` input signal resets the entire core.

## Programming Sequence

If processing parameters (such as the image size) need to be changed on-the-fly, or the system needs to be reinitialized, it is recommended that pipelined Xilinx IP video cores are disabled/reset from system output towards the system input, and programmed/enabled from system input to system output. `STATUS` register bits allow system processors to identify the processing states of individual constituent cores, and successively disable a pipeline as one core after another is finished processing the last frame of data.

## Error Propagation and Recovery

Parameterization and/or configuration registers define the dimensions of video frames video IP should process. Starting from a known state, based on these configuration settings the IP can predict when the beginning of the next frame is expected. Similarly, the IP can predict when the last pixel of each scan line is expected. `SOF` detected before it was expected (early), or `SOF` not present when it is expected (late), `EOL` detected before expected (early), or `EOL` not present when expected (late), signals error conditions indicative of either upstream communication errors or incorrect core configuration.

When `SOF` is detected early, the output `SOF` signal is generated early, terminating the previous frame immediately. When `SOF` is detected late, the output `SOF` signal is generated according to the programmed values. Extra lines / pixels from the previous frame are dropped until the input `SOF` is captured.

Similarly, when `EOL` is detected early, the output `EOL` signal is generated early, terminating the previous line immediately. When `EOL` is detected late, the output `EOL` signal is

generated according to the programmed values. Extra pixels from the previous line are dropped until the input `EOL` is captured.

## Shared Look-Up Tables

When multiple channels require the same correction curve, a single LUT may be shared between two or more channels. Sharing LUTs between multiple channels reduces the number of write operations required to update the LUTs when using the AXI4-Lite interface. It also can reduce the number of block RAM resources used.

Discontinued IP

## Interpolation of Look-up Table Contents

When the gamma function is configured for 12-bit input data, an optional look-up table interpolation is provided to reduce the size of look-up tables and thereby the number of block RAMs. This interpolation stores every 4th sample in the look-up table (Figure 3-3), which can reduce the number of block RAMs used by 75%. The Gamma Correction core supports linear interpolation, which trades off block RAM(s) for adders to implement the 1-to-4 interpolation. When used to interpolate sufficiently smooth functions, such as the power functions used for gamma correction, the interpolation error is orders of magnitude smaller than the output quantization error.

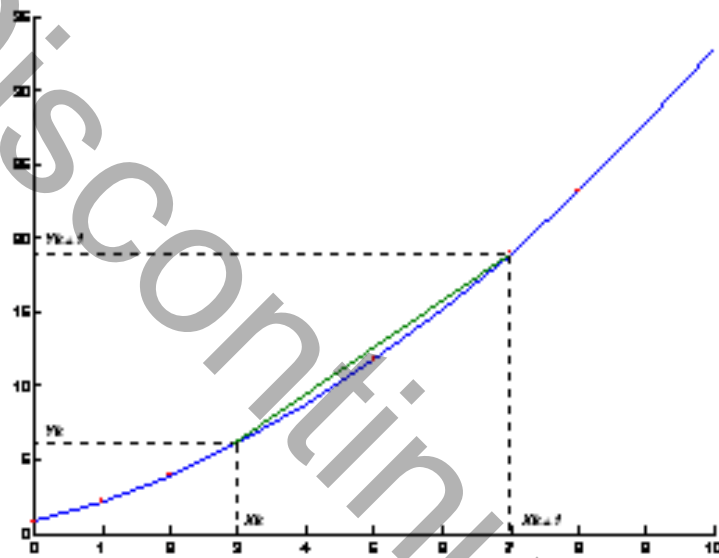

Figure 3-3: Interpolation of Look-up Table Contents

# Customizing and Generating the Core

This chapter includes information about using Xilinx tools to customize and generate the core in the Vivado® Design Suite environment.

---

## Vivado Integrated Design Environment

You can customize the IP for use in your design by specifying values for the various parameters associated with the IP core using the following steps:

1. Select the IP from the IP catalog.
2. Double-click on the selected IP or select the Customize IP command from the toolbar or popup menu.

For details, see the sections, “Working with IP” and “Customizing IP for the Design” in the *Vivado Design Suite User Guide: Designing with IP* ([UG896](#)) [Ref 3] and the “Working with the Vivado IDE” section in the *Vivado Design Suite User Guide: Getting Started* ([UG910](#)) [Ref 5].

If you are customizing and generating the core in the Vivado IP Integrator, see the *Vivado Design Suite User Guide: Designing IP Subsystems using IP Integrator* (UG994) [Ref 7] for detailed information. IP Integrator might auto-compute certain configuration values when validating or generating the design. To check whether the values do change, see the description of the parameter in this chapter. To view the parameter value you can run the `validate_bd_design` command in the Tcl console.

**Note:** Figures in this chapter are illustrations of the Vivado IDE. This layout might vary from the current version.

---

## Interface

The Gamma Correction core is easily configured to meet the user's specific needs through the Vivado Design Suite GUI. This section provides a quick reference to parameters that can be configured at generation time. [Figure 4-1](#) shows the main Vivado Gamma Correction screen.

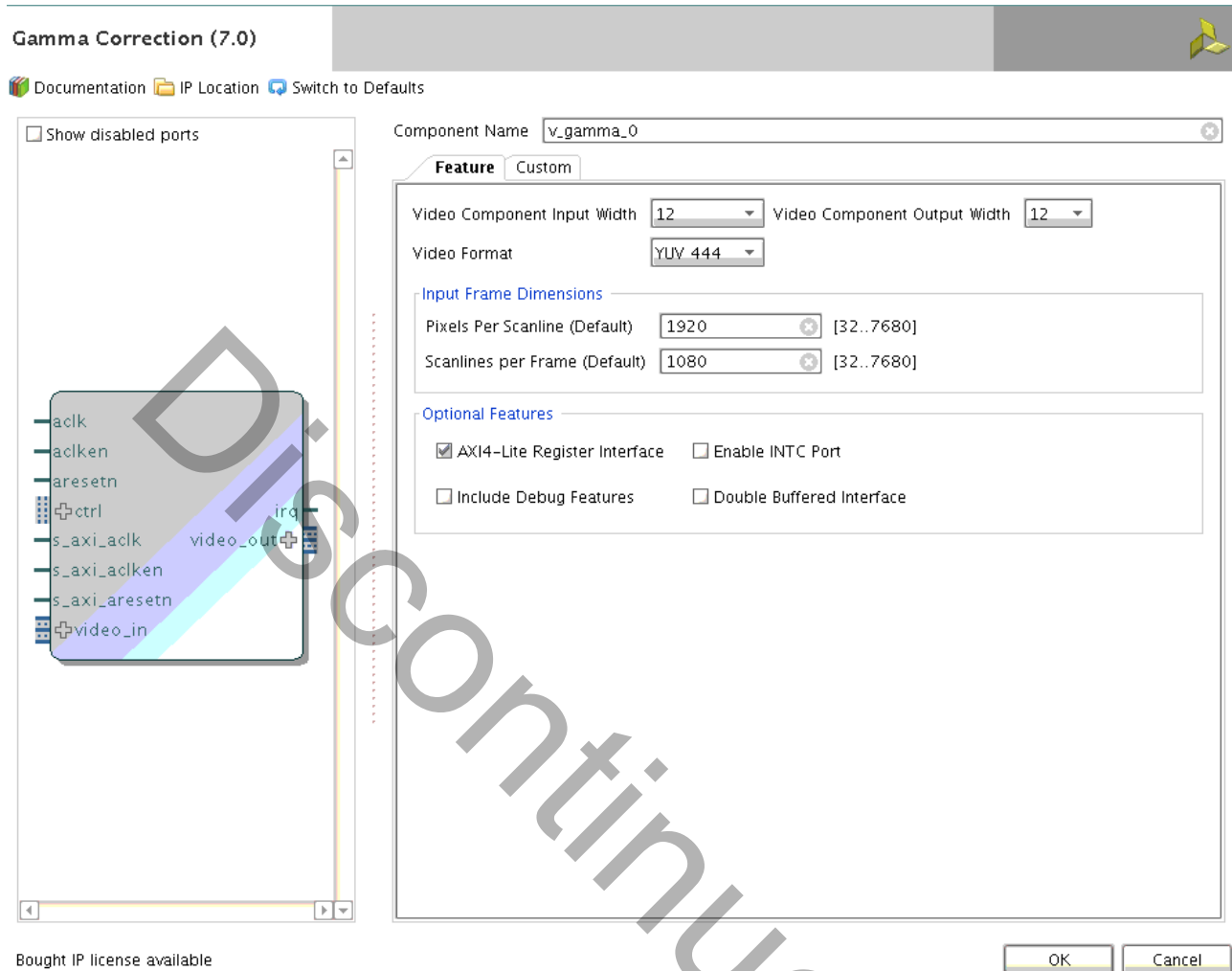

Figure 4-1: Gamma Correction Vivado IP Catalog GUI

The main screen displays a representation of the IP symbol on the left side, and the parameter assignments on the right side, which are described as follows:

- **Component Name:** The component name is used as the base name of output files generated for the module. Names must begin with a letter and must be composed from characters: a to z, 0 to 9 and "\_". **The name v\_gamma\_v7\_0 is not allowed.**
- **Video Format:** Specifies the format of the video to be processed. Permitted values are RGB and YUV 4:4:4, YUV 4:2:2, YUV 4:2:0 and Mono. When using IP Integrator, this parameter is automatically computed based on the Video Format of the video IP core connected to the slave AXI-Stream video interface.
- **Video Component Input Width:** Specifies the bit width of the input color channel for each component. Permitted values are 8, 10 and 12 bits.
- **Video Component Output Width:** Specifies the bit width of the output color channel for each component. Permitted values are 8, 10 and 12 bits.



- **Pixels Per Scanline (Default):** When the AXI4-Lite control interface is enabled, the generated core will use the value specified in the Vivado GUI as the default value for the lower half-word of the `ACTIVE_SIZE` register. When an AXI4-Lite interface is not present, the GUI selection permanently defines the horizontal size of the frames the generated core instance is to process.
- **Scanlines Per Frame (Default):** When the AXI4-Lite control interface is enabled, the generated core will use the value specified in the Vivado GUI as the default value for the upper half-word of the `ACTIVE_SIZE` register. When an AXI4-Lite interface is not present, the GUI selection permanently defines the vertical size (number of lines) of the frames the generated core instance is to process.
- **Optional Features:**
  - **AXI4-Lite Register Interface:** When selected, the core will be generated with an AXI4-Lite interface, which gives access to dynamically program and change processing parameters. For more information, refer to [Control Interface in Chapter 2](#).
  - **Include Debug Features:** When selected, the core will be generated with debugging features, which simplify system design, testing and debugging. For more information, refer to [Debug Tools in Appendix C](#).



---

**IMPORTANT:** *Debugging features are only available when the AXI4-Lite Register Interface is selected.*

---

- **Enable INTC Port:** When selected, the core will generate the optional `INTC_IF` port, which gives parallel access to signals indicating frame processing status and error conditions. For more information, refer to [The Interrupt Subsystem in Chapter 2](#).
- **Double Buffered Interface:** Double-buffering is used to eliminate tearing of the output images by writing to an inactive look-up table, then providing the ability to swap inactive and active look-up tables. This feature is only available for the AXI4-Lite Interface. However, using this feature may increase the memory footprint of the core.

Figure 4-2 shows the main Vivado Gamma Correction screen.

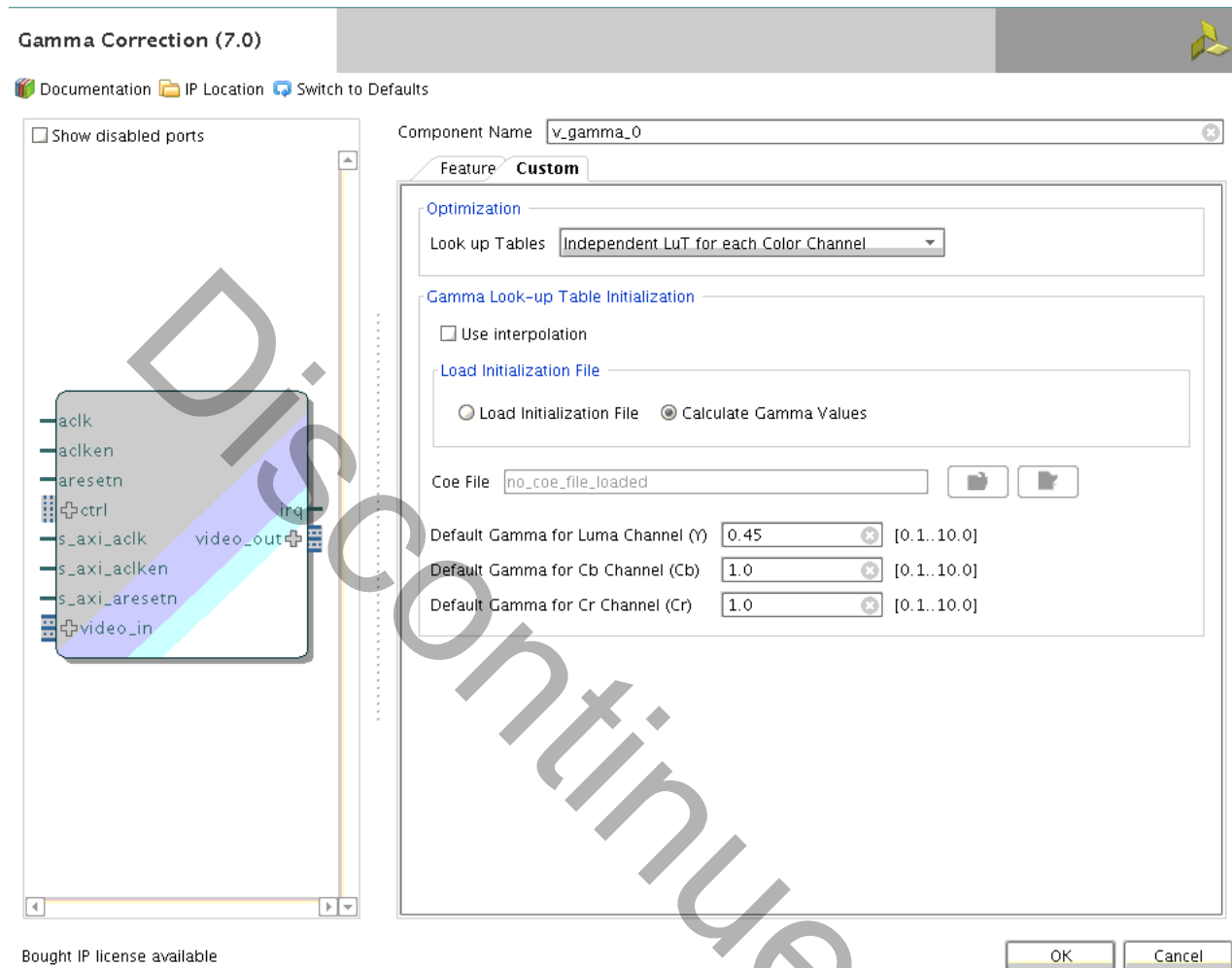

Figure 4-2: Gamma Correction Vivado IP Catalog GUI

- **Optimization:** Specifies options to reduce memory usage. There are three LUTs option from the drop list:
  - **Independent LUTs for each Color Channel:** When selected, each color channel uses a separate look-up table, permitting each channel to implement a distinct function. This option requires the most Block RAM resources.
  - **Identical LUTs for Chrominance Channels Only:** When selected, the chrominance channels (Cr, Cb) will share the same look-up table contents. (This also applies to the U and V channels for YUV. This option is not applicable when the Video Format is RGB. When two channels can use the same look-up table, the required number of write operations to modify the function stored in the look-up tables is reduced, and in some cases the number of Block RAM resources required is reduced.
  - **Identical LUTs for all Color Channels:** When selected, the red, green, and blue (or luminance and chrominance channels) all share the same look-up table contents. When all channels can use the same look-up tables, the required number of write

operations to modify the function stored in the look-up tables is reduced, and in some cases the number of Block RAM resources required is reduced.

- **Gamma Look-Up Table Initialization**

- **Use Interpolation:** Interpolation is used to reduce block RAM counts when using 12-bit input from 4k entries per look-up table to only 1k per look-up table.
- **Load Initialization File:** When selected, the Load Initialization File feature allows a custom COE file to be loaded which specifies the contents of the gamma look-up tables. This permits the Gamma Correction core to be used to implement any function for a variety of tasks.
- **Calculate Gamma Values:** When selected, specifies the gamma value for initializing the look-up tables. Permitted values are floating-point values from 0.1 to 10. If the Input Data Width is different from the Output Data Width, the generated tables are sized and scaled appropriately.
- **Coe File:** Shows the full path of Coe file that been selected through the browser button. The Coe file content can be modified by using the Edit button right beside the browser.
- **Default Gamma for Luma Channel (Y):** Specifies the gamma value for Luma Channel that used to initialize the gamma table. Range from 0.1 to 10.0
- **Default Gamma for Cb Channel (Cb):** Specifies the gamma value for Chrominance Channel, Cb that used to initialize the gamma table. Range from 0.1 to 10.0.
- **Default Gamma for Cr Channel (Cr):** Specifies the gamma value for Chrominance Channel, Cr that used to initialize the gamma table. Range from 0.1 to 10.0.

## Output Generation

For details, see "Generating IP Output Products" in the *Vivado Design Suite User Guide: Designing with IP* ([UG896](#)).

# Constraining the Core

---

## Required Constraints

The only constraints required are clock frequency constraints for the video clock, `clk`, and the AXI4-Lite clock, `s_axi_aclk`. Paths between the two clock domains should be constrained with a `max_delay` constraint and use the `datapathonly` flag, causing setup and hold checks to be ignored for signals that cross clock domains. These constraints are provided in the XDC constraints file included with the core.

# C Model Reference

The Gamma Correction core has a bit accurate C model designed for system modeling.

---

## Features

- Bit-accurate with the Gamma Correction v7.0 core
  - Statically linked library (.lib for Windows)
  - Dynamically linked library (.so for Linux)
  - Available for 32-bit and 64-bit Windows platforms and 32-bit and 64-bit Linux platforms
  - Supports all features of the Gamma Correction core that affect numerical results
  - Designed for rapid integration into a larger system model
  - Example C code showing how to use the function is provided
  - Example application C code wrapper file supports 8-bit YUV and BIN
- 

## Overview

The Gamma Correction core has a bit-accurate C model for 32-bit and 64-bit Windows platforms and 32-bit and 64-bit Linux platforms. The model's interface consists of a set of C functions residing in a statically linked library (shared library).

See [Using the C Model](#) for full details of the interface. A C code example of how to call the model is provided in [C-Model Example Code](#).

The model is bit accurate, as it produces exactly the same output data as the core on a frame-by-frame basis. However, the model is not cycle accurate, and it does not model the core's latency or its interface signals.

## Unpacking the Model Contents

Unzip the `v_gamma_v7_0_bitacc_model.zip` file creates the following directory structures and files which are described in [Table 6-1](#).

**Table 6-1: C Model Files**

File	Description
/lin	Pre-compiled bit accurate ANSI C reference model for simulation on 32-bit Linux Platforms
libIp_v_gamma_v7_0_bitacc_cmodel.so	Model shared object library
run_bitacc_cmodel	Pre-compiled bit accurate executable for simulation on 32-bit Linux Platforms
/lin64	Pre-compiled bit accurate ANSI C reference model for simulation on 64-bit Linux Platforms
libIp_v_gamma_v7_0_bitacc_cmodel.so	Model shared object library
run_bitacc_cmodel	Pre-compiled bit accurate executable for simulation on 32-bit Linux Platforms
/nt	Pre-compiled bit accurate ANSI C reference model for simulation on 32-bit Windows Platforms
libIp_v_gamma_v7_0_bitacc_cmodel.lib	Pre-compiled library file for win32 compilation
run_bitacc_cmodel.exe	Pre-compiled bit accurate executable for simulation on 32-bit Windows Platforms
/nt64	Pre-compiled bit accurate ANSI C reference model for simulation on 64-bit Windows Platforms
libIp_v_gamma_v7_0_bitacc_cmodel.lib	Pre-compiled library file for win32 compilation
run_bitacc_cmodel.exe	Pre-compiled bit accurate executable for simulation on 64-bit Windows Platforms
v_gamma_v7_0_bitacc_cmodel.h	Model header file
rgb_utils.h	Header file declaring the RGB image / video container type and support functions
bmp_utils.h	Header file declaring the bitmap (.bmp) image file I/O functions
video_utils.h	Header file declaring the generalized image / video container type, I/O and support functions.
Kodim19_128x192.bmp	128x192 sample test image of the Lighthouse image from the True-color Kodak test images
run_bittacc_cmodel.c	Example code calling the C Model

## Installation

The installation of the C-Model requires updates to the PATH variable, as described below.

## Linux

For Linux, make sure file is in a directory that in your \$LD\_LIBRARY\_PATH environment variable:

- libIp\_v\_gamma\_v7\_0\_bit yacc\_cmodel.so

## Software Requirements

The Gamma Correction v7.0 C models were compiled and tested with the following software versions.

Table 6-2: Supported Systems and Software Requirements

Platform	C Compiler
Linux 32-bit and 64-bit	GCC 4.1.1
Windows 32-bit and 64-bit	Microsoft Visual Studio 2008

## Using the C Model

The bit accurate C model is accessed through a set of functions and data structures that are declared in the v\_gamma\_v7\_0\_bitacc\_cmodel.h file.

Before using the model, the structures holding the inputs, generics and output of the Gamma Correction instance must be defined:

```

struct xilinx_ip_v_gamma_v7_0_generics gamma_generics;
struct xilinx_ip_v_gamma_v7_0_inputs gamma_inputs;
struct xilinx_ip_v_gamma_v7_0_outputs gamma_outputs;
    
```

The declaration of these structures is in the v\_gamma\_v7\_0\_bitacc\_cmodel.h file.

Table 6-3 lists the generic parameters taken by the Gamma Correction v7.0 IP core bit accurate model, as well as the default values. For an actual instance of the core, these parameters can only be set in generation time through the Xilinx software GUI.

Table 6-3: Model Generic Parameters and Default Values

Generic variable	Type	Default Value	Range	Description
IWIDTH	int	8	8,10,12	Input data width.
OWIDTH	int	8	8,10,12	Output data width.
VIDEO_FORMAT	int	2	0,1,2,3,1 2	Video Format 0=YUV 4:2:2 1=YUV 4:4:4 2=RGB 3=YUV 4:2:0 4=Mono

Table 6-3: Model Generic Parameters and Default Values (Cont'd)

INTPOL	int	0	0,1	Interpolation 0=No Interpolation 1=Use Interpolation Interpolation is only valid for IWIDITH=12
NUM_CHANNELS	int	3	1,2,3	Number of valid channels to be processed
LUTS	int	3	1,2,3	Specifies how the LUTs are initialized: 3=Each channel has an independent LUT 2=Channel 1 has an independent LUT, channels 2&3 use the same LUT 1=All channels use the same LUT
default_gamma1	double	0.45	0.1 - 10.0	Double precision value used to initialize the default contents of the gamma correction table for channel 1
default_gamma2	double	0.45	0.1 - 10.0	Double precision value used to initialize the default contents of the gamma correction table for channel 2. Only valid when LUTS > 1.
default_gamma3	double	0.45	0.1 - 10.0	Double precision value used to initialize the default contents of the gamma correction table for channel 3. Only valid when LUTS = 3.

Calling `xilinx_ip_v_gamma_v7_0_get_default_generics (&gamma_generics)` initializes the generics structure with the Gamma GUI defaults, listed in Table 6-3.

Table 6-4: Core Generic Parameters and Default Values

Input Variable	Type	Default Value	Range	Description
video_in	video_struct	Null	N/A	Container to hold input image or video data. <sup>1</sup>
TABLE1	uint16[4096]	$\text{round}\left(255 \frac{k^{0.45}}{255^{0.45}}\right)$	0 to $2^{OWIDTH}-1$	Correction Tables for Channels 1,2 and 3. For RGB, R=1, G=2, B=3. For YUV 4:4:4, Y=1, U=2, V=3, For YUV 4:2:2/0, Y=1, U/V=2. For Mono, Y=1.
TABLE2	uint16[4096]			
TABLE3	uint16[4096]			

<sup>1</sup> For the description of the input structure, see [Initializing the Input Video Structure](#).

The structure `gamma_inputs` defines the values of run time parameters and the actual input image. The TABLES 1-3 can be set dynamically through the AXI4-Lite interface. Consequently, these values are passed as inputs to the core, along with the actual test image, or video sequence (see Table 6-4).

Calling `xilinx_ip_v_gamma_v7_0_get_default_inputs (&gamma_generics, &gamma_inputs)` initializes members of the input structure default values (see Table 6-4).



**IMPORTANT:** The `video_in` variable is not initialized because the initialization depends on the actual test image to be simulated. [Chapter 6, C-Model Example Code](#) describes the initialization of the `video_in` structure.

After the inputs are defined, the model can be simulated by calling this function:

```
int xilinx_ip_v_gamma_v7_0_bitacc_simulate(
```



```

struct xilinx_ip_v_gamma_v7_0_generics* generics,
struct xilinx_ip_v_gamma_v7_0_inputs* inputs,
struct xilinx_ip_v_gamma_v7_0_outputs* outputs).
    
```

Results are included in the outputs structure, which contains only one member, type `video_struct`. After the outputs are evaluated and saved, dynamically allocated memory for input and output video structures must be released by calling this function:

```

void xilinx_ip_v_gamma_v7_0_destroy(
struct xilinx_ip_v_gamma_v7_0_inputs *input,
struct xilinx_ip_v_gamma_v7_0_outputs *output).
    
```

Successful execution of all provided functions, except for the destroy function, return value 0. A non-zero error code indicates that problems occurred during function calls.

## Input and Output Video Structure

Input images or video streams can be provided to the Gamma Correction v7.0 reference model using the `video_struct` structure, defined in `video_utils.h`:

```

struct video_struct{
    int frames, rows, cols, bits_per_component, mode;
    uint16*** data[5]; };
    
```

Table 6-5: Member Variables

Member Variable	Designation
frames	Number of video/image frames in the data structure.
rows	Number of rows per frame. Pertaining to the image plane with the most rows and columns, such as the luminance channel for YUV data. Frame dimensions are assumed constant through all frames of the video stream. However different planes, such as y, u and v can have different dimensions.
cols	Number of columns per frame. Pertaining to the image plane with the most rows and columns, such as the luminance channel for YUV data. Frame dimensions are assumed constant through all frames of the video stream. However different planes, such as y, u and v can have different dimensions.
bits_per_component	Number of bits per color channel/component. All image planes are assumed to have the same color/component representation. Maximum number of bits per component is 16.
mode	Contains information about the designation of data planes. Named constants to be assigned to mode are listed in <a href="#">Table 6-6</a> .
data	Set of five pointers to three dimensional arrays containing data for image planes. Data is in 16-bit unsigned integer format accessed as <code>data[plane][frame][row][col]</code> .

Table 6-6: Named Constants with Planes and Representations <sup>(1)</sup>

Mode	Planes	Video Representation
FORMAT_MONO	1	Monochrome – Luminance only
FORMAT_RGB	3	RGB image/video data
FORMAT_C444	3	444 YUV, or YCrCb image/video data
FORMAT_C422	3	422 format YUV video, ( u, v chrominance channels horizontally sub-sampled)
FORMAT_C420	3	420 format YUV video, ( u, v sub-sampled both horizontally and vertically )
FORMAT_MONO_M	3	Monochrome (Luminance) video with Motion
FORMAT_RGBA	4	RGB image/video data with alpha (transparency) channel
FORMAT_C420_M	5	420 YUV video with Motion
FORMAT_C422_M	5	422 YUV video with Motion
FORMAT_C444_M	5	444 YUV video with Motion
FORMAT_RGBM	5	RGB video with Motion

1. The Gamma Correction core supports the FORMAT\_RGB, FORMAT\_C444, FORMAT\_C422, FORMAT\_C420, and FORMAT\_MONO modes.

## Initializing the Input Video Structure

The easiest way to assign stimuli values to the input video structure is to initialize it with an image or video. The `bmp_util.h` and `video_util.h` header files packaged with the bit accurate C models contain functions to facilitate file I/O.

### Bitmap Image Files

The header `bmp_utils.h` declares functions that help access files in Windows Bitmap format ([http://en.wikipedia.org/wiki/BMP\\_file\\_format](http://en.wikipedia.org/wiki/BMP_file_format)). However, this format limits color depth to a maximum of 8-bits per pixel, and operates on images with three planes (R,G,B). Consequently, the following functions operate on arguments type `rgb8_video_struct`, which is defined in `rgb_utils.h`. Also, both functions support only true-color, non-indexed formats with 24-bits per pixel.

```
int write_bmp(FILE *outfile, struct rgb8_video_struct *rgb8_video);
int read_bmp(FILE *infile, struct rgb8_video_struct *rgb8_video);
```

Exchanging data between `rgb8_video_struct` and general `video_struct` type frames/videos is facilitated by these functions:

```
int copy_rgb8_to_video(struct rgb8_video_struct* rgb8_in,
                     struct video_struct* video_out );
int copy_video_to_rgb8(struct video_struct* video_in,
                     struct rgb8_video_struct* rgb8_out );
```

**Note:** All image/video manipulation utility functions expect both input and output structures initialized; for example, pointing to a structure that has been allocated in memory, either as static or dynamic variables. Moreover, the input structure must have the dynamically allocated container (data or r, g, b) structures already allocated and initialized with the input frame(s). If the output container structure is pre-allocated at the time of the function call, the utility functions verify and issue an error if the output container size does not match the size of the expected output. If the output container structure is not pre-allocated, the utility functions create the appropriate container to hold results.

## Binary Image/Video Files

The `video_utils.h` header file declares functions that help load and save generalized video files in raw, uncompressed format.

```
int read_video( FILE* infile,  struct video_struct* in_video);
int write_video(FILE* outfile, struct video_struct* out_video);
```

These functions serialize the `video_struct` structure. The corresponding file contains a small, plain text header defining, "Mode", "Frames", "Rows", "Columns", and "Bits per Pixel". The plain text header is followed by binary data, 16-bits per component in scan line continuous format. Subsequent frames contain as many component planes as defined by the video mode value selected. Also, the size (rows, columns) of component planes can differ within each frame as defined by the actual video mode selected.

## Working with Video\_struct Containers

The `video_utils.h` header file defines functions to simplify access to video data in `video_struct`.

```
int video_planes_per_mode(int mode);
int video_rows_per_plane(struct video_struct* video, int plane);
int video_cols_per_plane(struct video_struct* video, int plane);
```

The `video_planes_per_mode` function returns the number of component planes defined by the mode variable, as described in [Table 6-6](#). The `video_rows_per_plane` and `video_cols_per_plane` functions return the number of rows and columns in a given plane of the selected video structure. The following example demonstrates using these functions in conjunction to process all pixels within a video stream stored in the `in_video` variable:

```
for (int frame = 0; frame < in_video->frames; frame++) {
    for (int plane = 0; plane < video_planes_per_mode(in_video->mode); plane++) {
        for (int row = 0; row < rows_per_plane(in_video,plane); row++) {
            for (int col = 0; col < cols_per_plane(in_video,plane); col++) {
                // User defined pixel operations on
                // in_video->data[plane][frame][row][col]
            }
        }
    }
}
```

## C-Model Example Code

An example C file, `run_bitacc_cmodel.c`, is provided to demonstrate the steps required to run the model. After following the compilation instructions, run the example executable. The executable takes the path/name of the input file and the path/name of the output file as parameters. If invoked with insufficient parameters, this help message is issued:

```
Usage: run_bitacc_cmodel in_file out_path
in_file   : path/name of the input BMP file
out_path  : path to the output files
```

During successful execution, two directories will be created at the location specified by the `out_path` command line parameter. The first directory is the "expected" directory. This directory contains a BMP file that corresponds to the output of the first frame that was processed. This directory will also contain a txt file called `golden_1.txt`. This txt file contains the output of the model in a format that can be directly used with the demonstration test bench. The second directory that is created is the "stimuli" directory. This directory will contain a txt file called `stimuli_1.txt`. This txt file contains the input of the model in a format that can be directly used with the demonstration test bench.

## Compiling with the Gamma C-Model

### Linux (32- and 64-bit)

To compile the example code, first ensure that the directory in which the file `libIp_v_gamma_v7_0_bitacc_cmodel.so` is located is present in your `$LD_LIBRARY_PATH` environment variable. These shared libraries are referenced during the compilation and linking process. Then `cd` into the directory where the header files, library files and `run_bitacc_cmodel.c` were unpacked. The libraries and header files are referenced during the compilation and linking process.

Place the header file and C source file in a single directory. Then in that directory, compile using the GNU C Compiler:

```
gcc -m32 -x c++ run_bitacc_cmodel.c gen_stim.c -o run_bitacc_cmodel -L.
-lIp_v_gamma_v7_0_bitacc_cmodel -Wl,-rpath,.
```

```
gcc -m64 -x c++ run_bitacc_cmodel.c gen_stim.c -o run_bitacc_cmodel -L.
-lIp_v_gamma_v7_0_bitacc_cmodel -Wl,-rpath,.
```

### Windows (32- and 64-bit)

Precompiled library `v_gamma_v7_0_bitacc_cmodel.dll`, and top level demonstration code `run_bitacc_cmodel.c` should be compiled with an ANSI C compliant compiler under Windows. Here an example is presented using Microsoft Visual Studio.

In Visual Studio create a new, empty Windows Console Application project. As existing items, add:

- The `llibIpv_gamma_v7_0_bitacc_cmodel.dll` and `llibIpv_gamma_v7_0_bitacc_cmodel.lib` files to the "Resource Files" folder of the project
- The `run_bitacc_cmodel.c` and `gen_stim.c` files to the "Source Files" folder of the project
- The `v_gamma_v7_0_bitacc_cmodel.h` header files to "Header Files" folder of the project (optional)

After the project has been created and populated, it needs to be compiled and linked (built) to create a win32 executable. To perform the build step, choose **Build Solution** from the Build menu. An executable matching the project name has been created either in the Debug or Release subdirectories under the project location based on whether **Debug** or **Release** has been selected in the **Configuration Manager** under the Build menu.

# Simulation

This chapter contains information about simulating IP in the Vivado® Design Suite environment. For comprehensive information about Vivado simulation components, as well as information about using supported third party tools, see the *Vivado Design Suite User Guide: Logic Simulation* (UG900) [\[Ref 6\]](#).

Discontinued IP

# Synthesis and Implementation

For details about synthesis and implementation, see “Synthesizing IP” and “Implementing IP” in the *Vivado Design Suite User Guide: Designing with IP* ([UG896](#)) [Ref 3].

Discontinued IP

## Detailed Example Design

No example design is available at the time for the Gamma Correction v7.0 core.

Discontinued IP



# Test Bench

This chapter contains information about the provided test bench in the Vivado® Design Suite environment.

---

## Demonstration Test Bench

A demonstration test bench is provided with the core which enables you to observe core behavior in a typical scenario. This test bench is generated together with the core in Vivado Design Suite. You are encouraged to make simple modifications to the configurations and observe the changes in the waveform.

### Directory and File Contents

The following files are expected to be generated in the in the demonstration test bench output directory:

- `axi4lite_mst.v`
- `axi4s_video_mst.v`
- `axi4s_video_slv.v`
- `ce_generator.v`
- `tb_<IP_instance_name>.v`

### Test Bench Structure

The top-level entity is `tb_<IP_instance_name>`.

It instantiates the following modules:

- DUT  
The <IP> core instance under test.
- `axi4lite_mst`

The AXI4-Lite master module, which initiates AXI4-Lite transactions to program core registers.

- `axi4s_video_mst`

The AXI4-Stream master module, which generates ramp data and initiates AXI4-Stream transactions to provide video stimuli for the core and can also be used to open stimuli files generated from the reference C models and convert them into corresponding AXI4-Stream transactions.

To do this, edit `tb_<IP_instance_name>.v`:

- Add define macro for the stimuli file name and directory path  

```
define STIMULI_FILE_NAME<path><filename>.
```
- Comment-out/remove the following line:  

```
MST.is_ramp_gen(`C_ACTIVE_ROWS, `C_ACTIVE_COLS, 2);
```

 and replace with the following line:  

```
MST.use_file(`STIMULI_FILE_NAME);
```

For information on how to generate stimuli files, see *Chapter 4, C Model Reference*.

- `axi4s_video_slv`

The AXI4-Stream slave module, which acts as a passive slave to provide handshake signals for the AXI4-Stream transactions from the core output, can be used to open the data files generated from the reference C model and verify the output from the core.

To do this, edit `tb_<IP_instance_name>.v`:

- Add define macro for the golden file name and directory path  

```
define GOLDEN_FILE_NAME "<path><filename>".
```
- Comment out the following line:  

```
SLV.is_passive;
```

 and replace with the following line:  

```
SLV.use_file(`GOLDEN_FILE_NAME);
```

For information on how to generate golden files, see *Chapter 4, C Model Reference*.

- `ce_gen`

Programmable Clock Enable (ACLKEN) generator.

# Verification, Compliance, and Interoperability

---

## Simulation

A highly parameterizable test bench was used to test the Gamma Correction core. Testing included the following:

- Register accesses
  - Processing multiple frames of data
  - AXI4-Stream bidirectional data-throttling tests
  - Testing detection, and recovery from various AXI4-Stream framing error scenarios
  - Testing different `ACLKEN` and `ARESETn` assertion scenarios
  - Testing of various frame sizes
  - Varying parameter settings
- 

## Hardware Testing

The Gamma Correction core has been validated in hardware at Xilinx to represent a variety of parameterizations, including the following:

- A test design was developed for the core that incorporated a MicroBlaze™ processor, AXI4-Lite interconnect and various other peripherals. The software for the test system included pre-generated input and output data along with live video stream. The MicroBlaze processor was responsible for:
  - Initializing the appropriate input and output buffers
  - Initializing the Gamma Correction core
  - Launching the test
  - Comparing the output of the core against the expected results

- Reporting the Pass/Fail status of the test and any errors that were found

---

## Interoperability

The core slave (input) AXI4-Stream interface can work directly with any Xilinx Video core that can produce the video format for which the Gamma Correction core is configured. The core master (output) AXI4-Stream interface can work directly with any Xilinx Video core which can consume the video format for which the Gamma Correction core is configured.

Discontinued IP

# Migrating and Upgrading

This appendix contains information about migrating from an ISE design to the Vivado Design Suite, and for upgrading to a more recent version of the IP core. For customers upgrading their IP core, important details (where applicable) about any port changes and other impact to user logic are included.

---

## Migrating to the Vivado Design Suite

For information about migration to Vivado Design Suite, see *ISE to Vivado Design Suite Migration Guide* (UG911) [\[Ref 2\]](#).

---

## Upgrading in Vivado Design Suite

This section provides information about any changes to the user logic or port designations that take place when you upgrade to a more current version of this IP core in the Vivado Design Suite.

### Parameter Changes

There are no parameter changes.

### Port Changes

There are no port changes.

### Other Changes

There are no other changes.

# Debugging

This appendix includes details about resources available on the Xilinx Support website and debugging tools.

---

## Finding Help on Xilinx.com

To help in the design and debug process when using the Image Enhancement, the [Xilinx Support web page](#) (Xilinx Support web page) contains key resources such as product documentation, release notes, answer records, information about known issues, and links for opening a Technical Support Web Case.

### Documentation

This product guide is the main document associated with the Image Enhancement. This guide, along with documentation related to all products that aid in the design process, can be found on the Xilinx Support web page or by using the Xilinx Documentation Navigator.

Download the Xilinx Documentation Navigator from the [Downloads page](#). For more information about this tool and the features available, open the online help after installation.

### Answer Records

Answer Records include information about commonly encountered problems, helpful information on how to resolve these problems, and any known issues with a Xilinx product. Answer Records are created and maintained daily ensuring that users have access to the most accurate information available.

Answer Records for this core are listed below, and can also be located by using the Search Support box on the main [Xilinx support web page](#). To maximize your search results, use proper keywords such as

- Product name
- Tool message(s)
- Summary of the issue encountered

A filter search is available after results are returned to further target the results.

### Answer Records for the Image Enhancement Core

AR [54523](#)

## Technical Support

Xilinx provides technical support in the Xilinx Support web page for this LogiCORE™ IP product when used as described in the product documentation. Xilinx cannot guarantee timing, functionality, or support if you do any of the following:

- Implement the solution in devices that are not defined in the documentation.
- Customize the solution beyond that allowed in the product documentation.
- Change any section of the design labeled DO NOT MODIFY.

Xilinx provides premier technical support for customers encountering issues that require additional assistance.

To contact Xilinx Technical Support, navigate to the [Xilinx Support web page](#).

1. Open a WebCase by selecting the [WebCase](#) link located under Support Quick Links.
  - A block diagram of the video system that explains the video source, destination and IP (custom and Xilinx) used.

**Note:**

---

## Debug Tools

There are many tools available to address Image Enhancement core design issues. It is important to know which tools are useful for debugging various situations.

### Vivado Lab Tools

Vivado® lab tools insert logic analyzer and virtual I/O cores directly into your design. Vivado lab tools allows you to set trigger conditions to capture application and integrated block port signals in hardware. Captured signals can then be analyzed. This feature represents the functionality in the Vivado IDE that is used for logic debugging and validation of a design running in Xilinx devices in hardware.

The Vivado lab tools logic analyzer is used to interact with the logic debug LogiCORE IP cores, including:

- ILA 2.0 (and later versions)

- VIO 2.0 (and later versions)

See *Vivado Design Suite User Guide: Programming and Debugging* ([UG908](#)).

## Reference Boards

Various Xilinx development boards support Image Enhancement. These boards can be used to prototype designs and establish that the core can communicate with the system.

- 7 series evaluation boards
  - KC705
  - KC724

## C Model Reference

See *C Model Reference* in this guide for tips and instructions for using the provided C model files to debug your design.

---

## Hardware Debug

Hardware issues can range from link bring-up to problems seen after hours of testing. This section provides debug steps for common issues. The Vivado lab tools are a valuable resource to use in hardware debug. The signal names mentioned in the following individual sections can be probed using the Vivado lab tools for debugging the specific problems.

### General Checks

Ensure that all the timing constraints for the core were properly incorporated from the example design and that all constraints were met during implementation.

- Does it work in post-place and route timing simulation? If problems are seen in hardware but not in timing simulation, this could indicate a PCB issue. Ensure that all clock sources are active and clean.
- If using MMCMs in the design, ensure that all MMCMs have obtained lock by monitoring the `LOCKED` port.
- If your outputs go to 0, check your licensing.

### Core Bypass Option

The bypass option facilitates establishing a straight through connection between input (AXI4-Stream slave) and output (AXI4-Stream master) interfaces bypassing any processing functionality.



Flag `BYPASS` (bit 4 of the `CONTROL` register) can turn bypass on (1) or off, when the core instance Debugging Features were enabled at generation. Within the IP this switch controls multiplexers in the AXI4-Stream path.

In bypass mode the core processing function is bypassed, and the core repeats AXI4-Stream input samples on its output.

Starting a system with all processing cores set to bypass, then by turning bypass off from the system input towards the system output allows verification of subsequent cores with known good stimuli.

## Built-in Test-Pattern Generator

The optional built-in test-pattern generator facilitates to temporarily feed the output AXI4-Stream master interface with a predefined pattern.

Flag `TEST_PATTERN` (bit 5 of the `CONTROL` register) can turn test-pattern generation on (1) or off, when the core instance **Debugging Features** were enabled at generation. Within the IP this switch controls multiplexers in the AXI4-Stream path, switching between the regular core processing output and the test-pattern generator. When enabled, a set of counters generate 256 scan-lines of color-bars, each color bar 64 pixels wide, repetitively cycling through Black, Green, Blue, Cyan, Red, Yellow, Magenta, and White colors till the end of each scan-line. After the Color-Bars segment, the rest of the frame is filled with a monochrome horizontal and vertical ramp.

Starting a system with all processing cores set to test-pattern mode, then by turning test-pattern generation off from the system output towards the system input allows successive bring-up and parameterization of subsequent cores.

## Throughput Monitors

Throughput monitors enable monitoring processing performance within the core. This information can be used to help debug frame-buffer bandwidth limitation issues, and if possible, allow video application software to balance memory pathways.

Often times video systems, with multiport access to a shared external memory, have different processing islands. For example, a pre-processing sub-system working in the input video clock domain may clean up, transform, and write a video stream, or multiple video streams to memory. The processing sub-system may read the frames out, process, scale, encode, then write frames back to the frame buffer, in a separate processing clock domain.

Finally, the output sub-system may format the data and read out frames locked to an external clock.

Typically, access to external memory using a multiport memory controller involves arbitration between competing streams. However, to maximize the throughput of the system, different memory ports may need different specific priorities. To fine tune the

arbitration and dynamically balance frame rates, it is beneficial to have access to throughput information measured in different video datapaths.

The `SYSDEBUG0` (0x0014) (or Frame Throughput Monitor) indicates the number of frames processed since power-up or the last time the core was reset. The `SYSDEBUG1` (0x0018), or Line Throughput Monitor, register indicates the number of lines processed since power-up or the last time the core was reset. The `SYSDEBUG2` (0x001C), or Pixel Throughput Monitor, register indicates the number of pixels processed since power-up or the last time the core was reset.

Priorities of memory access points can be modified by the application software dynamically to equalize frame, or partial frame rates.

## Evaluation Core Timeout

The Image Enhancement hardware evaluation core times out after approximately eight hours of operation. The output is driven to zero. This results in a black screen for RGB color systems and in a dark-green screen for YUV color systems.

# Interface Debug

## AXI4-Lite Interfaces

Table C-1 describes how to troubleshoot the AXI4-Lite interface.

Table C-1: Troubleshooting the AXI4-Lite Interface

Symptom	Solution
Readback from the Version Register through the AXI4-Lite interface times out, or a core instance without an AXI4-Lite interface seems non-responsive.	Are the <code>S_AXI_ACLK</code> and <code>ACLK</code> pins connected? The <code>VERSION_REGISTER</code> readout issue may be indicative of the core not receiving the AXI4-Lite interface.
Readback from the Version Register through the AXI4-Lite interface times out, or a core instance without an AXI4-Lite interface seems non-responsive.	Is the core enabled? Is <code>s_axi_aclken</code> connected to <code>vcc</code> ? Verify that signal <code>ACLKEN</code> is connected to either <code>net_vcc</code> or to a designated clock enable signal.

Table C-1: Troubleshooting the AXI4-Lite Interface (Cont'd)

Symptom	Solution
Readback from the Version Register through the AXI4-Lite interface times out, or a core instance without an AXI4-Lite interface seems non-responsive.	Is the core in reset? S_AXI_ARESETn and ARESETn should be connected to vcc for the core not to be in reset. Verify that the S_AXI_ARESETn and ARESETn signals are connected to either net_vcc or to a designated reset signal.
Readback value for the VERSION_REGISTER is different from expected default values	The core and/or the driver in a legacy project has not been updated. Ensure that old core versions, implementation files, and implementation caches have been cleared.

Assuming the AXI4-Lite interface works, the second step is to bring up the AXI4-Stream interfaces.

## AXI4-Stream Interfaces

Table C-2 describes how to troubleshoot the AXI4-Stream interface.

Table C-2: Troubleshooting AXI4-Stream Interface

Symptom	Solution
Bit 0 of the ERROR register reads back set.	Bit 0 of the ERROR register, EOL_EARLY, indicates the number of pixels received between the latest and the preceding End-Of-Line (EOL) signal was less than the value programmed into the ACTIVE_SIZE register. If the value was provided by the Video Timing Controller core, read out ACTIVE_SIZE register value from the VTC core again, and make sure that the TIMING_LOCKED flag is set in the VTC core. Otherwise, using Vivado Lab Tools, measure the number of active AXI4-Stream transactions between EOL pulses.
Bit 1 of the ERROR register reads back set.	Bit 1 of the ERROR register, EOL_LATE, indicates the number of pixels received between the last End-Of-Line (EOL) signal surpassed the value programmed into the ACTIVE_SIZE register. If the value was provided by the Video Timing Controller core, read out ACTIVE_SIZE register value from the VTC core again, and make sure that the TIMING_LOCKED flag is set in the VTC core. Otherwise, using Vivado Lab Tools, measure the number of active AXI4-Stream transactions between EOL pulses.
Bit 2 or Bit 3 of the ERROR register reads back set.	Bit 2 of the ERROR register, SOF_EARLY, and bit 3 of the ERROR register SOF_LATE indicate the number of pixels received between the latest and the preceding Start-Of-Frame (SOF) differ from the value programmed into the ACTIVE_SIZE register. If the value was provided by the Video Timing Controller core, read out ACTIVE_SIZE register value from the VTC core again, and make sure that the TIMING_LOCKED flag is set in the VTC core. Otherwise, using Vivado Lab Tools, measure the number EOL pulses between subsequent SOF pulses.
s_axis_video_tready stuck low, the upstream core cannot send data.	During initialization, line-, and frame-flushing, the core keeps its s_axis_video_tready input low. Afterwards, the core should assert s_axis_video_tready automatically. Is m_axis_video_tready low? If so, the core cannot send data downstream, and the internal FIFOs are full.

Table C-2: Troubleshooting AXI4-Stream Interface (Cont'd)

Symptom	Solution
m_axis_video_tvalid stuck low, the downstream core is not receiving data	<ul style="list-style-type: none"> <li>No data is generated during the first two lines of processing.</li> <li>If the programmed active number of pixels per line is radically smaller than the actual line length, the core drops most of the pixels waiting for the (s_axis_video_tlast) End-of-line signal. Check the ERROR register.</li> </ul>
Generated SOF signal (m_axis_video_tuser0) signal misplaced.	Check the ERROR register.
Generated EOL signal (m_axis_video_tlast) signal misplaced.	Check the ERROR register.
Data samples lost between Upstream core and this core. Inconsistent EOL and/or SOF periods received.	<ul style="list-style-type: none"> <li>Are the Master and Slave AXI4-Stream interfaces in the same clock domain?</li> <li>Is proper clock-domain crossing logic instantiated between the upstream core and this core (Asynchronous FIFO)?</li> <li>Did the design meet timing?</li> <li>Is the frequency of the clock source driving the ACLK pin lower than the reported Fmax reached?</li> </ul>
Data samples lost between Downstream core and this core. Inconsistent EOL and/or SOF periods received.	<ul style="list-style-type: none"> <li>Are the Master and Slave AXI4-Stream interfaces in the same clock domain?</li> <li>Is proper clock-domain crossing logic instantiated between the upstream core and this core (Asynchronous FIFO)?</li> <li>Did the design meet timing?</li> <li>Is the frequency of the clock source driving the ACLK pin lower than the reported Fmax reached?</li> </ul>

If the AXI4-Stream communication is healthy, but the data seems corrupted, the next step is to find the correct configuration for this core.

## Other Interfaces

Table C-3 describes how to troubleshoot third-party interfaces.

Table C-3: Troubleshooting Third-Party Interfaces

Symptom	Solution
Severe color distortion or color-swap when interfacing to third-party video IP.	Verify that the color component logical addressing on the AXI4-Stream TDATA signal is in according to <i>Data Interface</i> in Chapter 2. If misaligned: In HDL, break up the TDATA vector to constituent components and manually connect the slave and master interface sides.
Severe color distortion or color-swap when processing video written to external memory using the AXI-VDMA core.	Unless the particular software driver was developed with the AXI4-Stream TDATA signal color component assignments described in <i>Data Interface</i> in Chapter 2 in mind, there are no guarantees that the software correctly identifies bits corresponding to color components. Verify that the color component logical addressing TDATA is in alignment with the data format expected by the software drivers reading/writing external memory. If misaligned: In HDL, break up the TDATA vector to constituent components, and manually connect the slave and master interface sides.

Discontinued IP

# Additional Resources

---

## Xilinx Resources

For support resources such as Answers, Documentation, Downloads, and Forums, see the Xilinx Support website at:

<http://Xilinx Support web page>.

For a glossary of technical terms used in Xilinx documentation, see:

[http://www.xilinx.com/support/documentation/sw\\_manuals/glossary.pdf](http://www.xilinx.com/support/documentation/sw_manuals/glossary.pdf). help

For a comprehensive listing of Video and Imaging application notes, white papers, reference designs and related IP cores, see the Video and Imaging Resources page at:

[http://www.xilinx.com/esp/video/refdes\\_listing.htm#ref\\_des](http://www.xilinx.com/esp/video/refdes_listing.htm#ref_des).

---

## References

These documents provide supplemental material useful with this user guide:

1. *Vivado AXI Reference Guide* ([UG1037](#))
2. *ISE to Vivado Design Suite Migration Guide* ([UG911](#))
3. *Vivado Design Suite User Guide: Designing with IP* ([UG896](#))
4. *Vivado Design Suite User Guide: Programming and Debugging* ([UG908](#))
5. *Vivado Design Suite User Guide: Getting Started* ([UG910](#))
6. *Vivado Design Suite User Guide: Logic Simulation* ([UG900](#))
7. *Vivado Design Suite User Guide: Designing IP Subsystems using IP Integrator* ([UG994](#))

## Revision History

The following table shows the revision history for this document.

Date	Version	Revision
11/18/2015	7.0	Added UltraScale+ support.
10/01/2014	7.0	Removed Application Software Development appendix.
12/18/2013	7.0	Added UltraScale Architecture support.
10/02/2013	7.0	Synch document version with core version. Updated Constraints. Removed Test Bench Simulation.
03/20/2013	4.0	Updated for core version. Updated Debugging Appendix. Removed ISE chapters.
10/16/2012	3.1	Updated for core version. Added Vivado test bench.
07/25/2012	3.0	Updated for core version. Added Vivado information.
04/24/2012	2.0	Updated for core version. Added Zynq-7000 devices, added AXI4-Stream interfaces, deprecated GPP interface.
10/19/2011	1.0	Initial Xilinx release of Product Guide, replacing DS719 and UG829.

## Notice of Disclaimer

The information disclosed to you hereunder (the "Materials") is provided solely for the selection and use of Xilinx products. To the maximum extent permitted by applicable law: (1) Materials are made available "AS IS" and with all faults, Xilinx hereby DISCLAIMS ALL WARRANTIES AND CONDITIONS, EXPRESS, IMPLIED, OR STATUTORY, INCLUDING BUT NOT LIMITED TO WARRANTIES OF MERCHANTABILITY, NON-INFRINGEMENT, OR FITNESS FOR ANY PARTICULAR PURPOSE; and (2) Xilinx shall not be liable (whether in contract or tort, including negligence, or under any other theory of liability) for any loss or damage of any kind or nature related to, arising under, or in connection with, the Materials (including your use of the Materials), including for any direct, indirect, special, incidental, or consequential loss or damage (including loss of data, profits, goodwill, or any type of loss or damage suffered as a result of any action brought by a third party) even if such damage or loss was reasonably foreseeable or Xilinx had been advised of the possibility of the same. Xilinx assumes no obligation to correct any errors contained in the Materials or to notify you of updates to the Materials or to product specifications. You may not reproduce, modify, distribute, or publicly display the Materials without prior written consent. Certain products are subject to the terms and conditions of the Limited Warranties which can be viewed at <http://www.xilinx.com/warranty.htm>; IP cores may be subject to warranty and support terms contained in a license issued to you by Xilinx. Xilinx products are not designed or intended to be fail-safe or for use in any application requiring fail-safe performance; you assume sole risk and liability for use of Xilinx products in Critical Applications: <http://www.xilinx.com/warranty.htm#critapps>.

© Copyright 2011–2013 Xilinx, Inc. Xilinx, the Xilinx logo, Artix, ISE, Kintex, Spartan, Virtex, Zynq, and other designated brands included herein are trademarks of Xilinx in the United States and other countries. All other trademarks are the property of their respective owners.